



2022 – 2023



VEHICLE
ELECTRONICS

IGNITION & SENSOR SPECIALIST

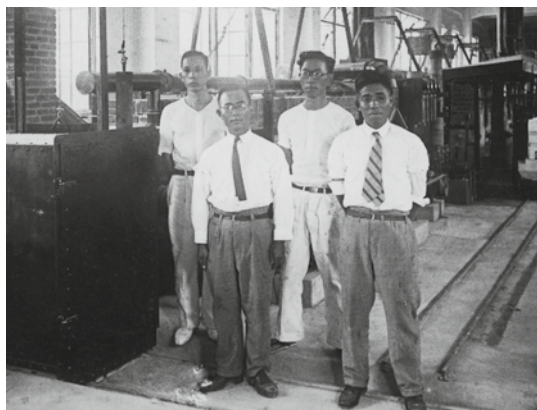

Founded in 1936, the NGK SPARK PLUG Corporate Group, known around the globe as a leading manufacturer of spark plugs, has always developed ceramics as its core competence. Over the years, the company has established a track record of successfully applying the expertise gained in the field of ceramics to other areas to create new value.

Today, NGK SPARK PLUG is a leading manufacturer of ignition parts and vehicle electronics both for OEMs (Original Equipment Manufacturers) and the IAM (Independent Aftermarket) with over 80 years of experience. A total of 41 subsidiaries, 29 production plants, 4 Technical Centers and 14,500 employees around the world ensure optimum processes and a great wealth of knowledge.

The world leader in spark plugs and oxygen sensors, NGK SPARK PLUG has built a strong reputation for quality, reliability and a commitment to excellence. Now as then, the ignition and sensor specialist is dedicated to providing customers with world-class products and services.

In order to react more quickly to the global and regional changes of the market and the NGK SPARK PLUG environment, the company has switched from a central to a regional company management model. As a result, NGK SPARK PLUG EUROPE GmbH, based in Ratingen, Germany, became the EMEA Regional Headquarter in 2017 and has extended its responsibility from only Europe to include Middle East and Africa. Today, the EMEA markets are key to NGK SPARK PLUG's success, making up 25 percent of NGK SPARK PLUG's total global sales.



1979

Foundation of
NGK SPARK PLUG
Deutschland GmbH

1989

NGK SPARK PLUG
Deutschland
becomes NGK SPARK
PLUG EUROPE

1997

First lambda sensor for
the Aftermarket available

2014

Introduction of NTK
exhaust gas temperature
sensors

2016

Launch of NTK MAP/MAF
sensors for the Aftermarket

2018

Launch of NTK engine
speed & position sensors
for the Aftermarket

2019

Foundation of
NGK SPARK PLUG
Deutschland GmbH

2022

Launch of NTK exhaust gas
recirculation valves for the
aftermarket



Launch of the
sensor brand NTK

1982

1989

NGK SPARK PLUG
Deutschland
becomes NGK SPARK
PLUG EUROPE

1997

First lambda sensor for
the Aftermarket available

2014

Introduction of NTK
exhaust gas temperature
sensors

2016

Launch of NTK MAP/MAF
sensors for the Aftermarket

2018

Launch of NTK engine
speed & position sensors
for the Aftermarket

2019

Foundation of
NGK SPARK PLUG
Deutschland GmbH

2022

Launch of NTK exhaust gas
recirculation valves for the
aftermarket

1991

Production plant in
Orléans (FR) and Technical
Center in Ratingen (DE)
start operation

Launch of V-Line,
the most successful
spark plug assortment

2012

Launch of NGK ignition
coils for the Aftermarket

2015



Acquisition of Wells,
a leading producer of
ignition coils and
sensors in the U.S.

2017

NGK SPARK PLUG EUROPE
takes over responsibility for
the EMEA region

Opening of the new Regional
Distribution Center in
Duisburg, Germany

2022

Launch of NTK exhaust gas
recirculation valves for the
aftermarket

MANUFACTURERS

MASS AIR FLOW SENSORS

A		I		O	
ALFA ROMEO	10	INFINITI	66	OPEL	101
ALPINA	13	ISUZU	67	P	
AUDI	14	IVECO	67	PEUGEOT	112
B		J		PORSCHE	119
BENTLEY	27	JAGUAR	68	PUCH	120
BMW	27	JEEP	69	R	
BOGDAN	34	K		RENAULT	120
C		KIA	69	ROVER	126
CADILLAC	34	L		S	
CHEVROLET	34	LADA	73	SAAB	126
CHRYSLER	35	LAMBORGHINI	75	SEAT	127
CITROËN	36	LANCIA	75	SKODA	131
D		LAND ROVER	76	SMART	134
DACIA	42	LEXUS	78	SSANGYONG	134
DAEWOO	43	LTI	79	SUBARU	135
DODGE	43	M		SUZUKI	135
DS	44	MAN	79	T	
F		MAZDA	80	TATA	137
FERRARI	44	MERCEDES-BENZ	83	TOYOTA	138
FIAT	44	MG	94	U	
FORD	51	MINI	95	UAZ	143
FORD USA	60	MITSUBISHI	95	V	
G		N		VAUXHALL	143
GAZ	60	NISSAN	96	VOLVO	154
H				VW	161
HONDA	60				
HUMMER	61				
HYUNDAI	61				



MANUFACTURERS

MANIFOLD / BOOST PRESSURE SENSORS











A		H		O	
ABARTH	266	HONDA	339	OPEL	405
ACURA	267	HYUNDAI	342	P	
ALFA ROMEO	267	I		PEUGEOT	417
ASTON MARTIN	270	INFINITI	353	PORSCHE	427
AUDI	270	ISUZU	353	PROTON	428
B		IVECO	354	PUCH	428
BENTLEY	283	J		R	
BMW	284	JAGUAR	356	RENAULT	429
C		JEEP	358	ROVER	445
CADILLAC	295	K		S	
CHEVROLET	295	KIA	358	SAAB	447
CHRYSLER	298	L		SEAT	449
CITROËN	298	LANCIA	365	SKODA	455
D		LAND ROVER	368	SMART	459
DACIA	309	LDV	370	SSANGYONG	460
DAEWOO	311	LEXUS	370	SUBARU	461
DAIHATSU	312	M		SUZUKI	461
DAIMLER	313	MAZDA	371	T	
DODGE	313	MERCEDES-BENZ	374	TOYOTA	464
DS	313	MG	396	V	
F		MINI	397	VAUXHALL	468
FIAT	313	MITSUBISHI	400	VOLVO	475
FORD	326	N		VW	488
G		NISSAN	400		
GEELY	339				



IGNITION
PARTS



VEHICLE
ELECTRONICS

MAF / MAP 	2 – 8
  	9 – 179
MAF 	180 – 200
Cross Reference Guide Original Equipment MAF → NTK	201 – 215
Cross Reference Guide Industry MAF → NTK	216 – 262
Discontinued Products	263 – 264
  	265 – 509
MAP 	510 – 530
Cross Reference Guide Original Equipment MAP → NTK	531 – 555
Cross Reference Guide Industry MAP → NTK	556 – 574
Discontinued Products	575 – 577
Legend 	578 – 581
Disclaimer	582 – 586

NTK AIRFLOW/PRESSURE SENSORS

🇬🇧 // How to read our part number:

Manifold /Boost Pressure Sensors, Mass Air Flow Sensors

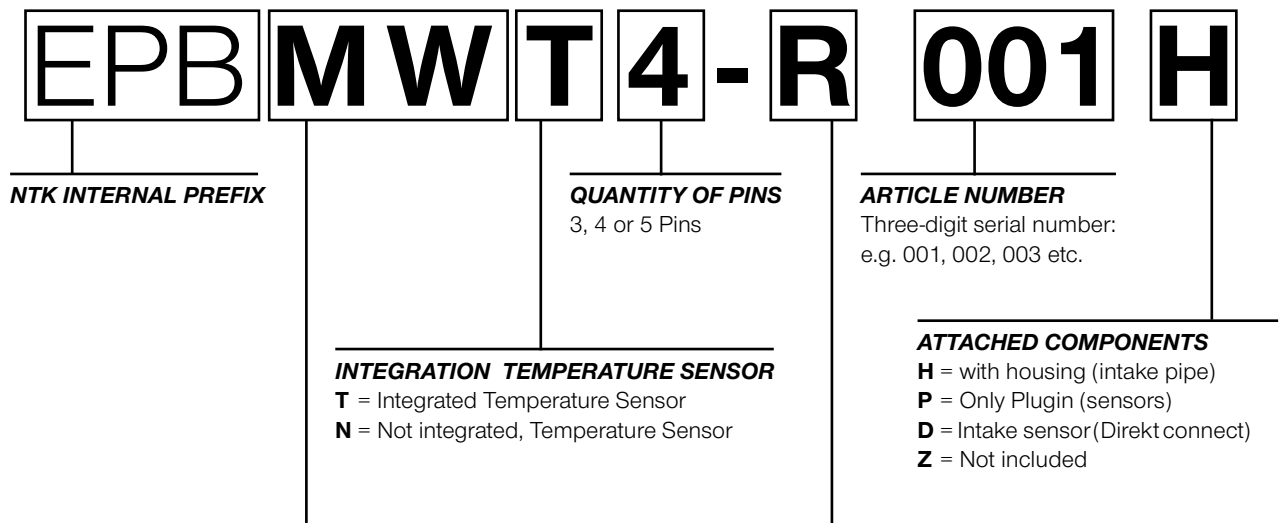

SENSOR CATEGORY

- MW** = Hot Wire Air Mass Meter
- MF** = Hot Film Air Mass Meter
- MP** = Manifold Absolute Pressure Sensor
- BP** = Boost Pressure Sensor
- MB** = Manifold and Boost Pressure Sensor

CONNECTOR SHAPE

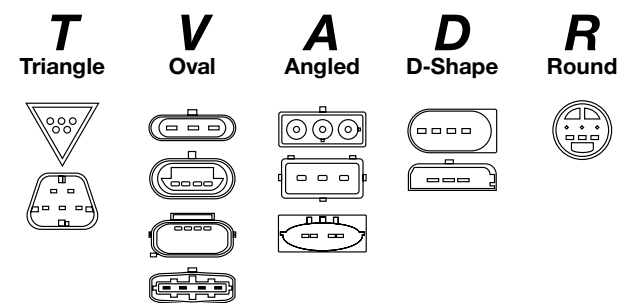

**DE // So entschlüsseln Sie unsere Teilenummern:
Saugrohr- / Ladedrucksensor, Luftmassenmesser**

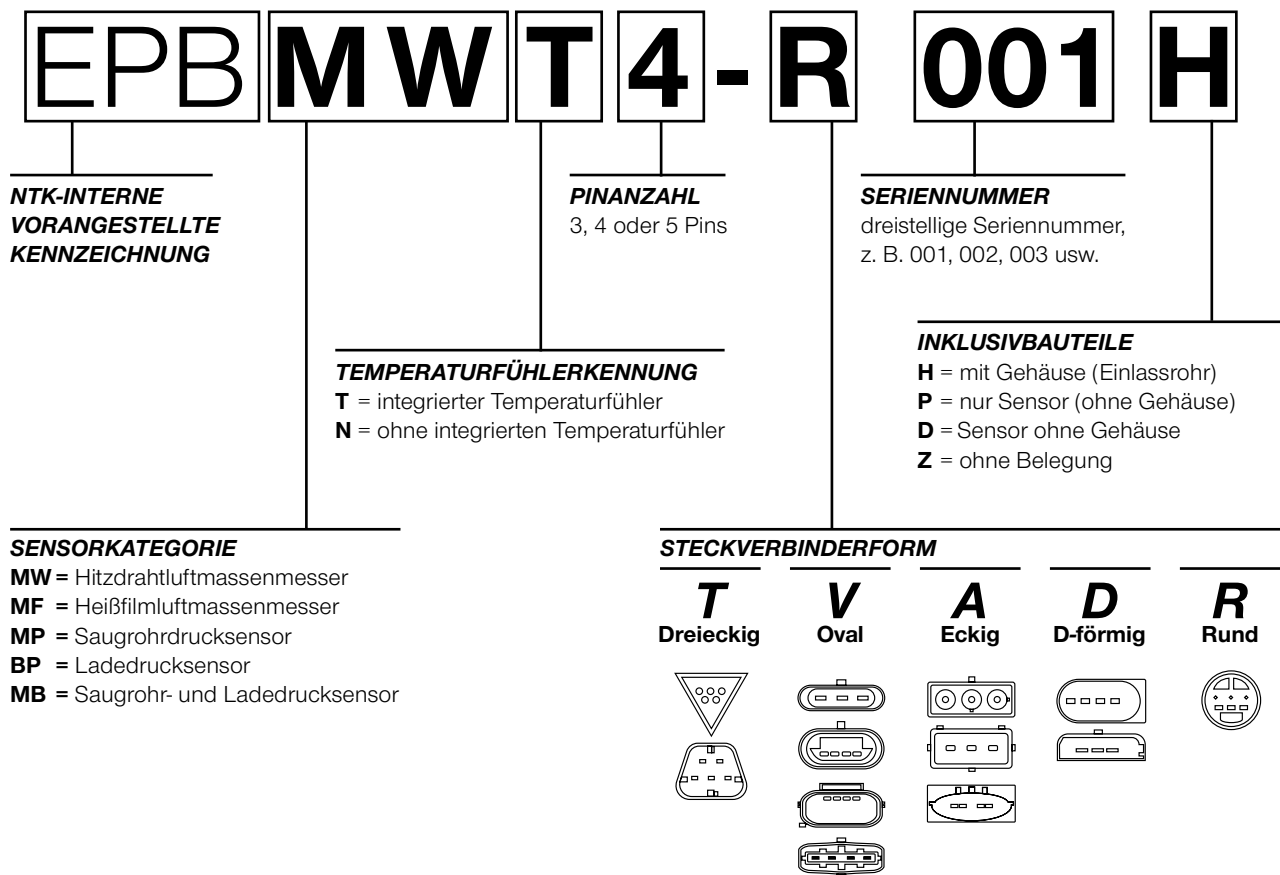

**FR // Comment lire notre numéro de pièce:
Capteurs de pression d'admission/de suralimentation, débitmètres d'air massique**

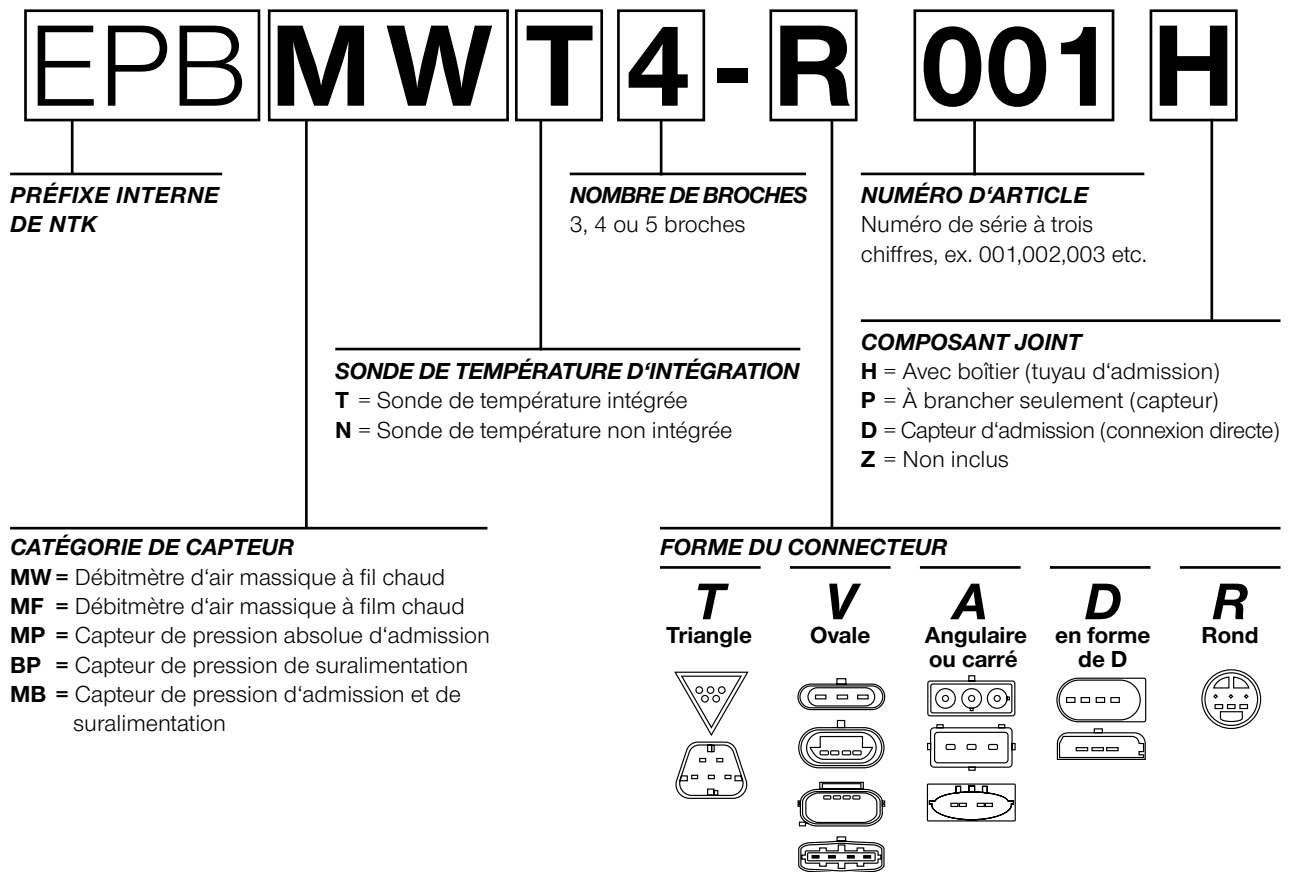

IT // Come leggere il nostro numero del pezzo:

Sensori della pressione di collettore / sovralimentazione, Sensori di flusso della massa d'aria

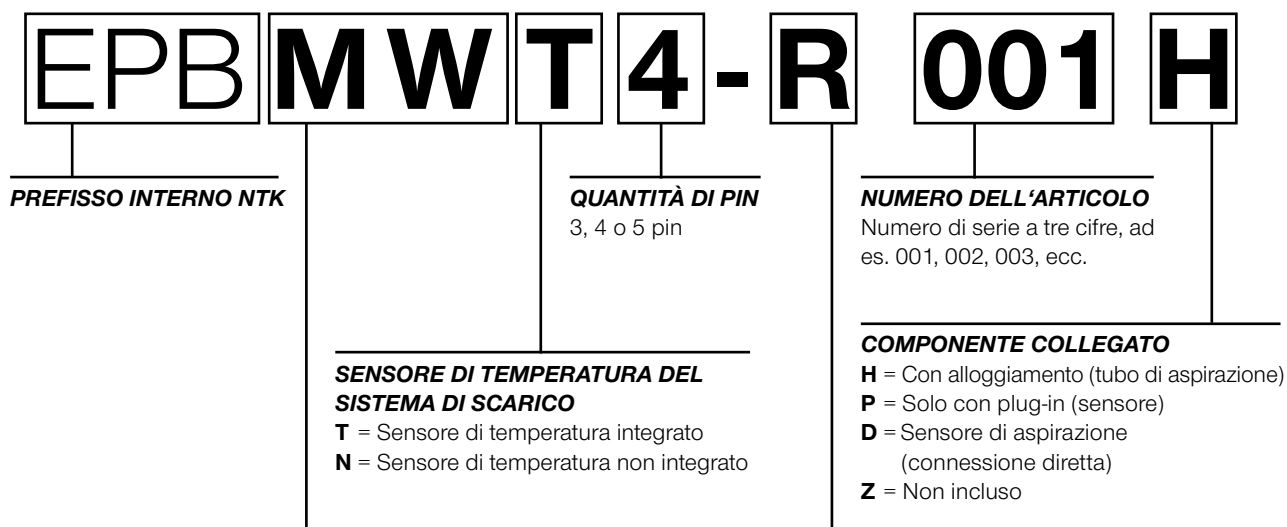

CATEGORIA DEL SENSORE
MW = Misuratore della massa d'aria a filo caldo
MF = Misuratore della massa d'aria a film caldo
MP = Sensore della pressione assoluta del collettore
BP = Sensore della pressione di sovralimentazione
MB = Sensore della pressione di collettore e sovralimentazione

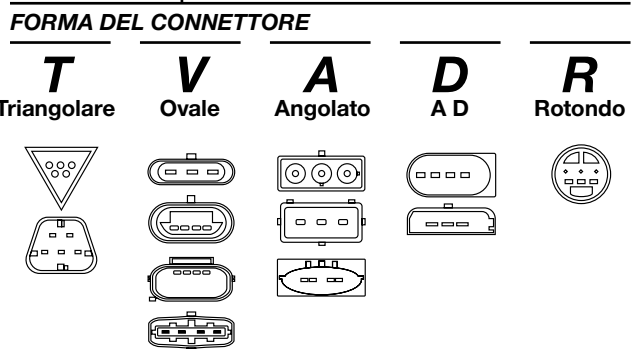

ES // Cómo leer nuestros números de pieza:

Sensores de colector/presión de sobrealimentación, sensores de flujo de aire

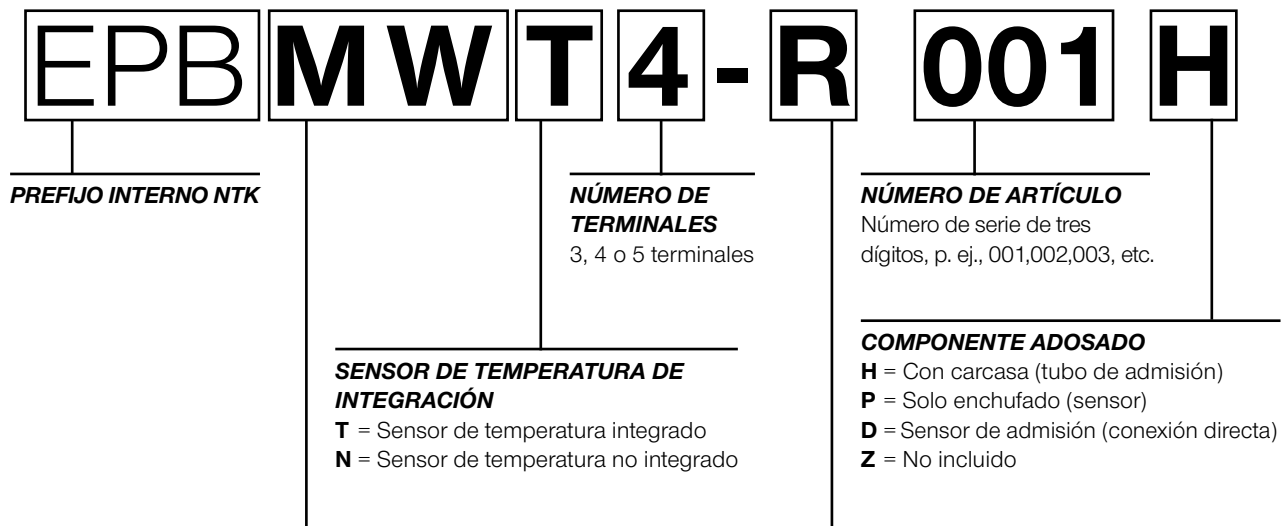

CATEGORÍA DEL SENSOR
MW = Medidor de masa de aire de película caliente
MF = Medidor de masa de aire de hilo caliente
MP = Sensor de presión absoluta del colector
BP = Sensor de presión de alimentación
MB = Sensor de presión del colector y de sobrealimentación

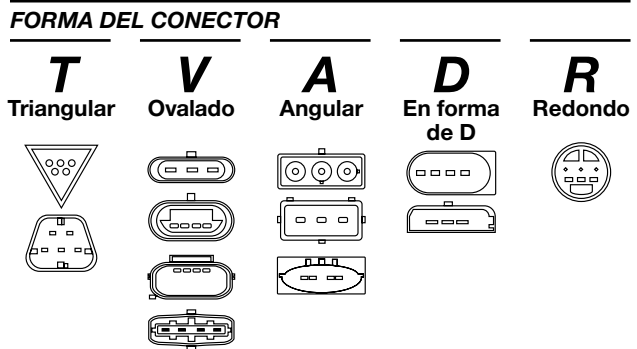

NL // Hoe moet ons onderdeelnummer worden gelezen:

Sensoren spuitstuk /aanjaagdruk, sensoren massaluchtstroom

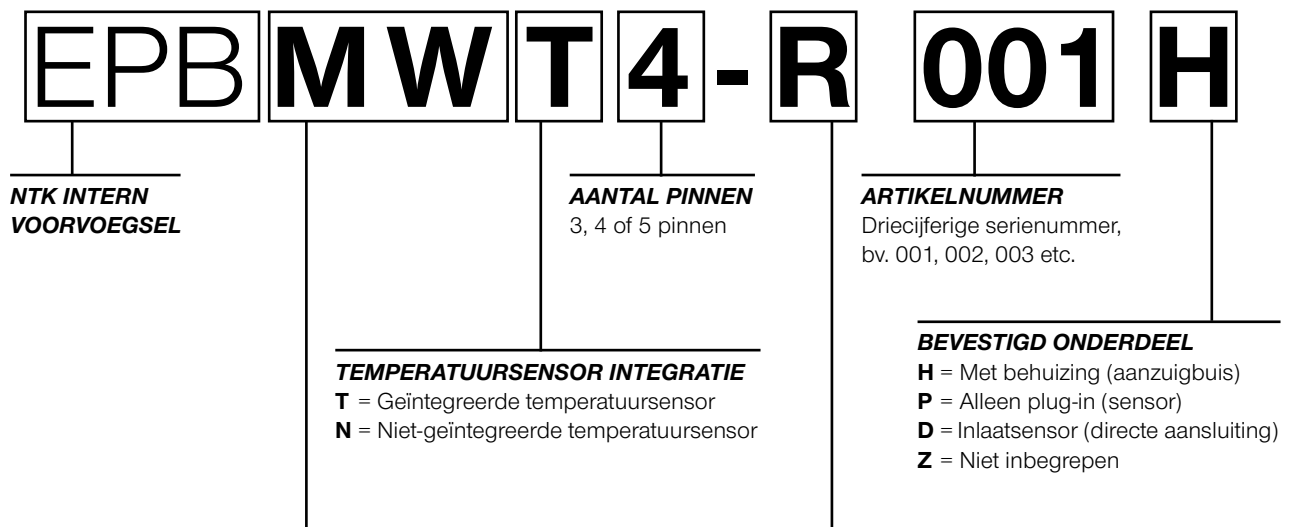

SENSORCATEGORIE
MW = Luchtmassameter met hittedraad
MF = Luchtmassameter met hittefilm
MP = Sensor absolute druk spuitstuk
BP = Sensor aanjaagdruk
MB = Sensor spuitstuk en aanjaagdruk

AANSLUITINGSVORM

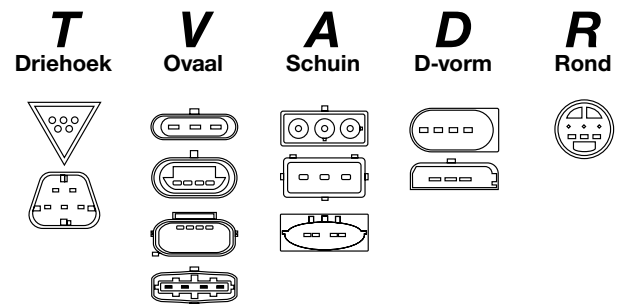

PT // Como ler o nosso número de peça:

Sensores de Pressão de Coletor /Propulsão, Sensores de Fluxo de Massa de Ar



CATEGORIA DE SENSOR
MW = Medidor de Massa de Ar de Fio Quente
MF = Medidor de Massa de Ar de Película Quente
MP = Sensor de Pressão Absoluta do Coletor
BP = Sensor de Pressão de Propulsão
MB = Sensor de Pressão do Coletor e de Propulsão

FORMA DO CONECTOR

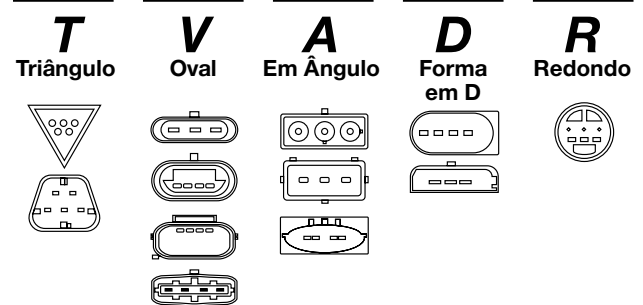

GR // Πώς να ερμηνεύετε τους κωδικούς μας:

Πολλαπλή / Αισθητήρες υψηλής πίεσης, Αισθητήρες απόλυτης πίεσης

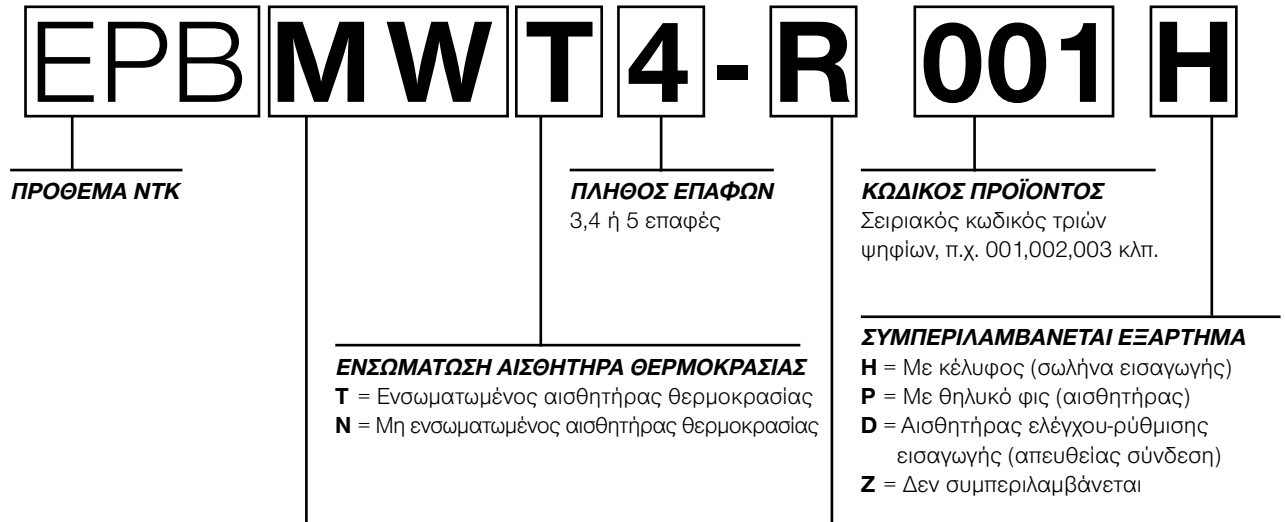

ΚΑΤΗΓΟΡΙΑ ΑΙΣΘΗΤΗΡΩΝ

MW = Μετρητής μάζας αέρα θερμού σύρματος
MF = Μετρητής μάζας αέρα θερμού φιλμ
MP = Αισθητήρας απόλυτης πίεσης πολλαπλής
BP = Αισθητήρας υψηλής πίεσης
MB = Αισθητήρας πολλαπλής και υψηλής πίεσης

ΣΧΗΜΑ ΒΥΣΜΑΤΟΣ

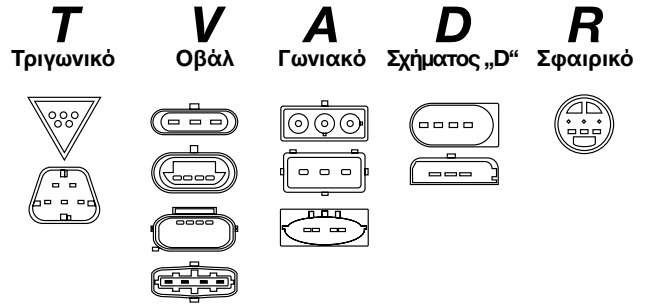

TR // Παρча numaramızın okunma şekli:

Manifold /Takviye Basıncı Sensörleri, Kütle Hava Akış Sensörleri

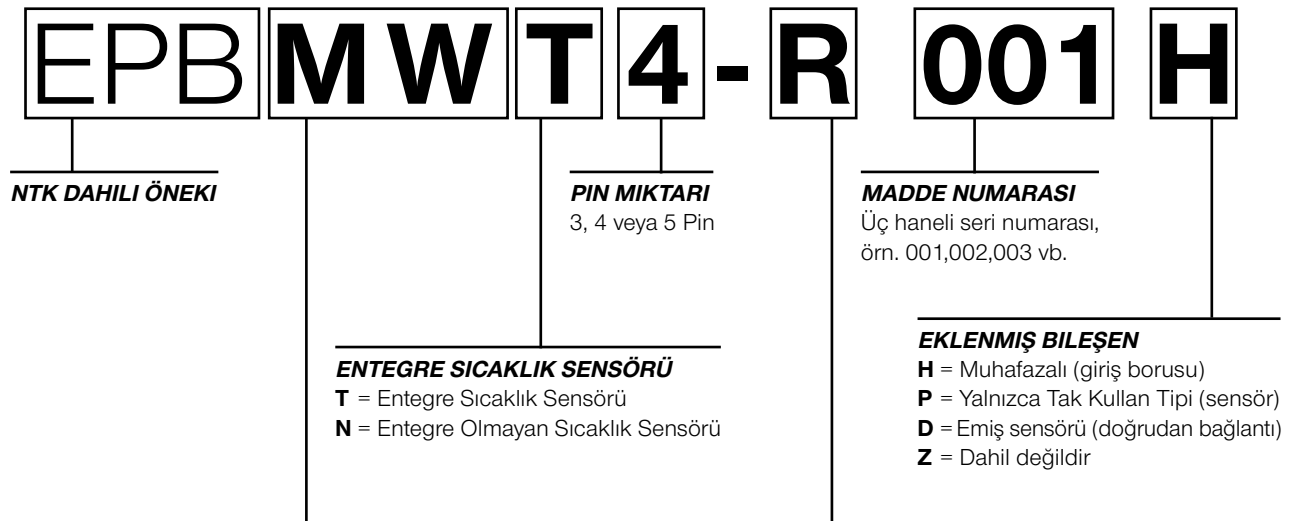

SENSÖR KATEGORİSİ

MW = Sıcak Tel Hava Kütle Ölçer
MF = Sıcak Film Hava Kütle Ölçer
MP = Manifold Mutlak Basınç Sensörü
BP = Takviye Basıncı Sensörü
MB = Manifold ve Takviye Basıncı Sensörü

KONEKTÖR ŞEKLİ

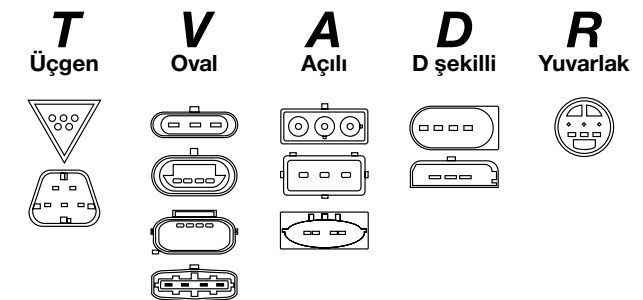

● **PL // Jak odczytać numer części:**

Czujniki kolektora/ciśnienia doładowania, przepływomierze masowe powietrza

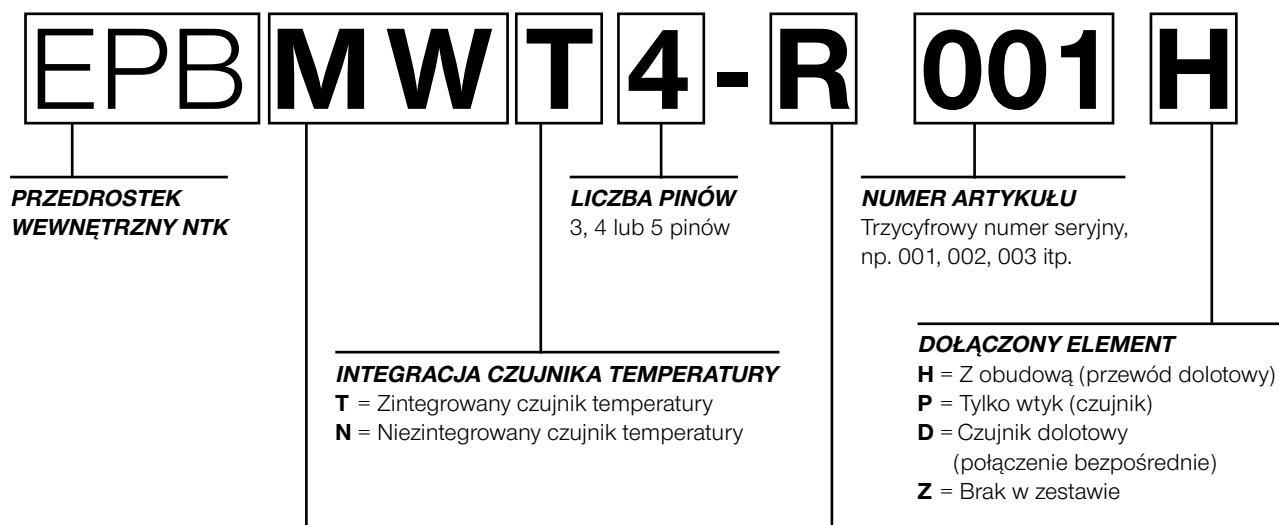

KATEGORIA CZUJNIKA

- MW** = Przepływomierz masowy powietrza z gorącym drutem
- MF** = Przepływomierz masowy powietrza z gorącą warstwą
- MP** = Czujnik ciśnienia bezwzględnego w kolektorze
- BP** = Czujnik ciśnienia doładowania
- MB** = Czujnik ciśnienia w kolektorze i ciśnienia doładowania

KSZTAŁT ZŁĄCZA

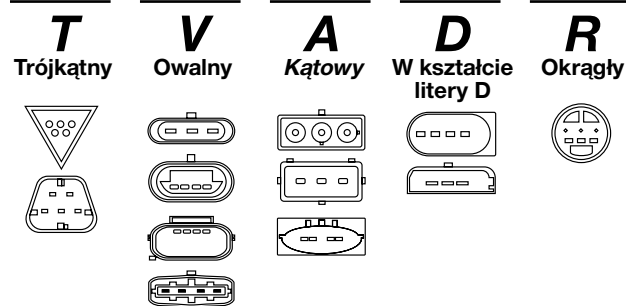

● **CZ // Jak číst naše číslo dílu:**

senzory / senzory na zvýšení tlaku, senzory masového přívodu vzduchu

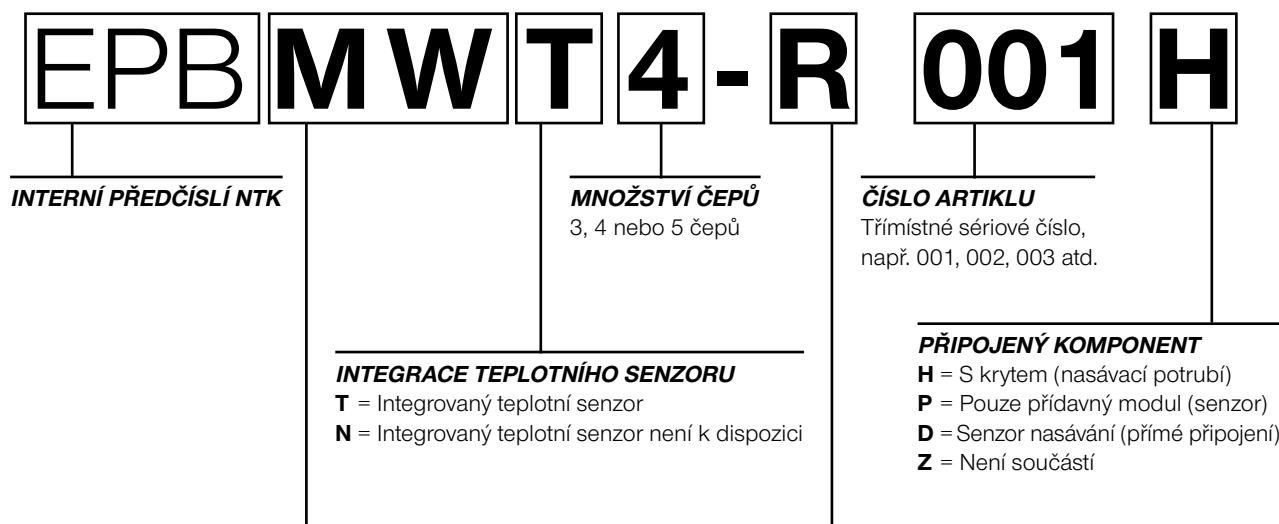

KATEGORIE SENZORU

- MW** = Snímač hmotnosti přiváděného vzduchu na principu vyhřívaného drátu
- MF** = Snímač hmotnosti přiváděného vzduchu na principu vyhřívané tenké vrstvy
- MP** = Snímač absolutního tlaku v sacím sběrném potrubí
- BP** = Snímač plnicího tlaku
- MB** = Snímač tlaku v sacím sběrném potrubí a plnicího tlaku

TVAR KONEKTORU

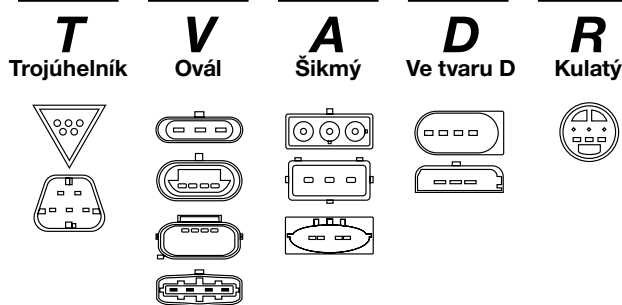

HU // Hogyan kell leolvasni a cikkszámot:

Szívócsonk /töltőnyomás-érzékelő, légtömegáram-érzékelők

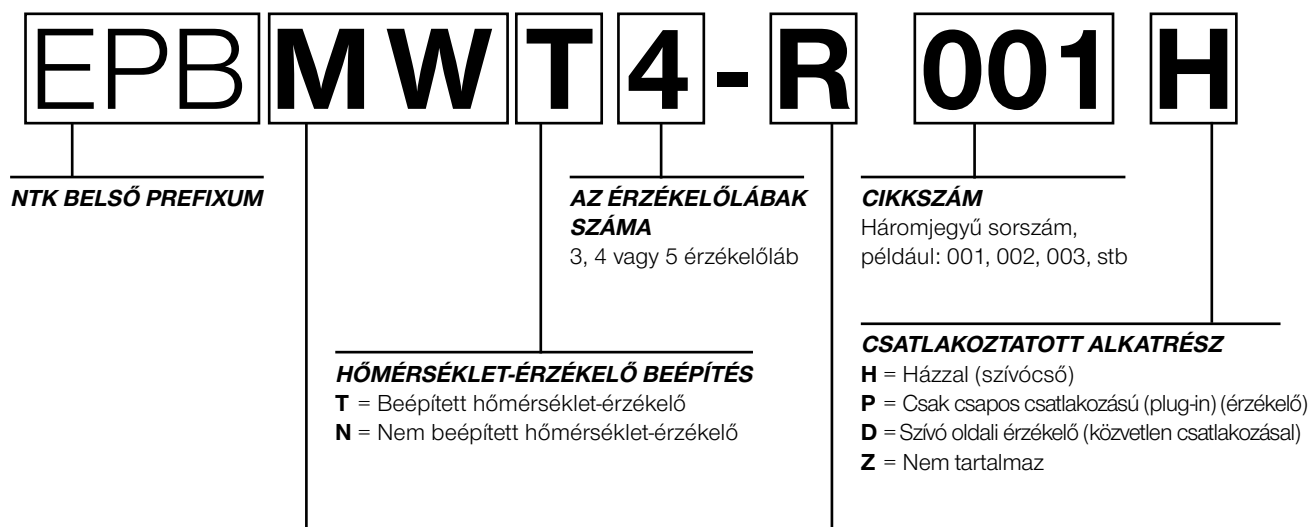

KATEGÓRIA ÉRZÉKELŐ
MW = Izzószálas légtömegmérő
MF = Fűtőfilmes légtömegmérő
MP = Abszolút nyomás érzékelő szívócsonk
BP = Töltőnyomás-érzékelő
MB = Szívócsonk és töltőnyomás-érzékelő

A CSATLAKOZÓ ALAKJA

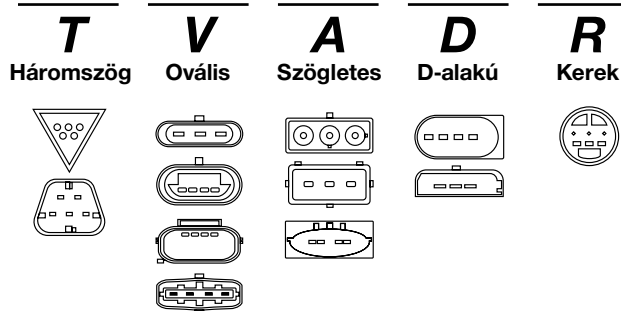

RU // Что означает код детали:

Датчики давления наддува / во впускном коллекторе, датчики массового расхода воздуха



КАТЕГОРИЯ ДАТЧИКА
MW = Электрический нагревательный расходомер воздуха с проволочным элементом
MF = Электрический нагревательный расходомер воздуха с пленочным элементом
MP = Датчик абсолютного давления во впускном коллекторе
BP = Датчик давления наддува
MB = Датчик давления наддува и давления во впускном коллекторе

ФОРМА РАЗЪЕМА





VEHICLE
ELECTRONICS

MAF



l kW
C
Y
I



Type-N°

Stock-N°

Plug In
Alternative
Type-N°

Plug In
Stock-N°

ALFA ROMEO

145 (930_)

1.4 i.e. 16V T.S.	1370	76	4	02.98-01.01	AR33503, AR38501		EPBMFT5-V007H	97257		
1.6 16V T.S.	1598	82	4	09.97-12.00	AR32102		EPBMFT5-V017H	90311		
1.6 16V T.S.	1598	82	4	09.97-12.00	AR32102		EPBMFN4-V017H	96226		
1.6 i.e. 16V T.S.	1598	88	4	12.96-01.01	AR38201		EPBMFT5-V017H	90311		
1.6 i.e. 16V T.S.	1598	88	4	12.96-01.01	AR67601		EPBMFN4-V017H	96226	EPBMFT5-V001P	93006
1.8 i.e. 16V	1747	106	4	03.98-01.01	AR32201		EPBMFN4-V017H	96226		
1.9 JTD	1910	77	4	02.99-01.01	AR32302		EPBMFT5-V017H	90311		
1.9 JTD	1910	77	4	02.99-01.01	AR32302		EPBMFN4-V017H	96226		
2.0 16V	1970	114	4	03.98-01.01	AR32301		EPBMFT5-V017H	90311		
2.0 16V	1970	114	4	03.98-01.01	AR32301		EPBMFN4-V017H	96226	EPBMFT5-V001P	93006

146 (930_)

1.6 16V T.S.	1598	82	4	09.97-12.00	AR32102		EPBMFT5-V017H	90311		
1.6 16V T.S.	1598	82	4	09.97-12.00	AR32102		EPBMFN4-V017H	96226		
1.6 i.e. 16V T.S.	1598	88	4	11.96-10.01	AR67601	VET>165089	EPBMFN4-V017H	96226		
1.6 i.e. 16V T.S.	1598	88	4	06.99-	AR67601		EPBMFT5-V017H	90311	EPBMFT5-V001P	93006
1.8 i.e. 16V T.S.	1747	106	4	06.99-	AR32201		EPBMFT5-V017H	90311	EPBMFT5-V001P	93006
1.9 JTD	1910	77	4	02.99-01.01	AR32302		EPBMFT5-V017H	90311		
1.9 JTD	1910	77	4	02.99-01.01	AR32302		EPBMFN4-V017H	96226		
1.9 TD	1929	66	4	12.94-02.99	AR33601, AR67501		EPBMFT5-V017H	90311		
2.0 16V	1970	114	4	03.97-10.01	AR32301		EPBMFN4-V017H	96226		
2.0 16V	1970	114	4	06.99-	AR32301		EPBMFT5-V017H	90311	EPBMFT5-V001P	93006

147 (937_)

1.9 JTD	1910	81	4	10.00-08.02	937A2000		EPBMFN4-V017H	96226		
1.9 JTD	1910	85	4	03.03-02.06	937A2000	; Chass.<3307874	EPBMFT5-V039H	90466		
1.9 JTDM	1910	85	4	10.04-03.10	939A7000		EPBMFN4-V017H	96226		
1.9 JTDM 8V	1910	88	4	07.05-03.10	937A3000		EPBMFN4-V017H	96226		
1.9 JTD 16V	1910	93	4	09.03-09.04	937A4000	Euro4	EPBMFN4-V017H	96226		
1.9 JTD 16V	1910	100	4	10.04-03.10	192B1000	Euro4	EPBMFN4-V017H	96226		
1.9 JTDM 16V	1910	125	4	06.08-03.10	937A6000		EPBMFN4-V017H	96226		
2.0 16V T.SPARK	1970	110	4	01.01-03.10	AR32310		EPBMFT5-V017H	90311		

156 / 156 SW (932_)

1.6 16V T.SPARK	1598	88	4	05.00-05.06	AR32102, AR32103, AR32104, AR67601		EPBMFT5-V017H	90311		
1.6 16V T.SPARK	1598	88	4	05.00-05.06	AR67601, AR32102	VET>0084341	EPBMFN4-V017H	96226		
1.8 16V T.SPARK	1747	103	4	02.97-05.06	AR32205		EPBMFT5-V017H	90311		
1.8 16V T.SPARK	1747	103	4	02.97-05.06	AR32205	Euro2	EPBMFN4-V017H	96226		
1.8 16V T.SPARK	1747	106	4	09.97-10.00	AR32201		EPBMFT5-V017H	90311	EPBMFT5-V001P	93006
1.8 16V T.SPARK	1747	106	4	09.97-10.00	AR32201	Euro2	EPBMFN4-V017H	96226		
1.9 JTD	1910	77	4	09.97-10.00	AR32302		EPBMFT5-V017H	90311		
1.9 JTD	1910	77	4	09.97-10.00	AR32302	Euro2	EPBMFN4-V017H	96226		
1.9 JTD	1910	81	4	10.00-05.01	AR37101	Euro2	EPBMFN4-V017H	96226		
1.9 JTD	1910	93	4	11.03-09.05	937A4000	Euro4	EPBMFN4-V026H	94497		
1.9 JTD 16V	1910	103	4	11.02-05.06	192A5000	Euro4	EPBMFN4-V026H	94497		



MAF



l kW
C
Y
I



Type-N°

Stock-N°

Plug In
Alternative
Type-N°

Plug In
Alternative

ALFA ROMEO

156 / 156 SW (932_)

1.9 JTD 16V	1910	103	4	09.03-	192A5000		EPBMFT5-V017H	90311		
1.9 JTD	1910	110	4	07.04-05.06	937A5000		EPBMFN4-V010H	97588		
1.9 JTD	1910	110	4	07.04-05.06	937A5000	Euro4	EPBMFN4-V026H	94497		
1.9 JTD 16V Q4	1910	110	4	07.04-05.06	937A5000	Euro4	EPBMFN4-V026H	94497		
1.9 JTD 16V Q4	1910	110	4	10.04-12.05	937A5000		EPBMFN4-V010H	97588		
2.0 16V T.SPARK	1970	110	4	10.00-03.02	AR32310		EPBMFT5-V017H	90311		
2.0 16V T.SPARK	1970	110	4	10.00-03.02	AR32310	Euro2	EPBMFN4-V017H	96226		
2.0 16V T.SPARK	1970	114	4	09.97-06.02	AR32301, AR32310		EPBMFT5-V017H	90311	EPBMFT5-V001P	93006
2.0 16V T.SPARK	1970	114	4	09.97-06.02	AR32301	Euro2	EPBMFN4-V017H	96226		
2.0 JTS	1970	119	4	03.01-09.05	932A2000		EPBMFT5-V017H	90311		
2.0 JTS	1970	122	4	06.02-	937A1000		EPBMFT5-V017H	90311		
2.4 JTD	2387	100	5	09.97-09.03	AR32501		EPBMFT5-V017H	90311		
2.4 JTD	2387	120	5	06.03-05.06	841M000		EPBMFT5-V035H	94119	EPBMFT5-V001P	93006
2.4 JTD	2387	129	5	10.03-09.05	841G000		EPBMFT5-V035H	94119	EPBMFT5-V001P	93006
2.5 V6 24V	2492	140	6	02.97-08.03	AR32401		EPBMFT5-V008H	93715		
2.5 V6 24V	2492	141	6	02.97-05.06	AR32405		EPBMFT5-V008H	93715		

159 / 159 SW (939_)

1.8 TBi	1742	147	4	05.09-12.12	939B1000		EPBMFT4-V061H	94528		
1.8 MPI	1796	103	4	06.05-11.11	939A4000		EPBMFT4-V061H	94528		
1.8 MPI	1796	103	4	05.07-11.11	939A4000		EPBMFT4-V048H	95493		
1.9 JTS	1859	118	4	09.05-11.11	939A6000		EPBMFT5-V020H	90244		
1.9 JTDM 8V	1910	85	4	03.06-12.08	937A7000, 939A7000		EPBMFN4-V010H	97588		
1.9 JTDM 8V	1910	85	4	03.06-11.11	939A7000, 937A7000		EPBMFN4-V026H	94497		
1.9 JTDM 8V	1910	88	4	09.05-11.11	939A1000		EPBMFN4-V026H	94497		
1.9 JTDM 8V	1910	88	4	09.05-12.08	939A1000		EPBMFN4-V010H	97588		
1.9 JTDM 16V	1910	100	4	03.06-11.11	937A8000		EPBMFN4-V010H	97588		
1.9 JTDM 16V	1910	100	4	03.06-11.11	939A8000, 937A8000		EPBMFN4-V026H	94497		
1.9 JTDM 16V	1910	110	4	09.05-11.11	939A2000		EPBMFN4-V010H	97588		
1.9 JTDM 16V	1910	110	4	03.06-11.11	939A2000		EPBMFN4-V026H	94497		
2.0 JTDM	1956	100	4	06.10-11.11	939B4000		EPBMFT4-V004H	90957		
2.0 JTDM	1956	120	4	05.09-11.11	844A2000		EPBMFT4-V004H	90957		
2.0 JTDM	1956	125	4	05.09-11.11	939B3000		EPBMFT4-V004H	90957		
2.2 JTS	2198	136	4	09.05-11.11	939A5000		EPBMFT5-V020H	90244		
2.4 JTDM	2387	147	5	03.06-11.11	939A3000		EPBMFN4-V020H	90971		
2.4 JTDM	2387	154	5	05.07-11.11	939A9000		EPBMFN4-V020H	90971		
2.4 JTDM Q4	2387	154	5	05.07-11.11	939A9000		EPBMFN4-V020H	90971		
3.2 JTS Q4	3195	191	6	02.06-11.11	939A000		EPBMFT5-V001P	93006		

166 (936_)

2.0 T.SPARK	1970	114	4	09.98-10.00	AR34103		EPBMFT5-V017H	90311		
-------------	------	-----	---	-------------	---------	--	---------------	-------	--	--



MAF



l kW
C
Y
I



Type-N°

Stock-N°

Plug In
Alternative
Type-N°

Plug In
Subtype

ALFA ROMEO

166 (936_)

2.0 T.SPARK	1970	114	4	09.98-10.00	AR34103		EPBMFT5-V001P	93006		
2.0 V6	1996	151	6	09.98-10.00	AR34102		EPBMFT5-V008H	93715		
2.0 V6	1996	151	6	09.98-10.00	AR34102		EPBMFT5-V019H	96039		
2.4 JTD	2387	100	5	09.98-10.00	AR34202		EPBMFT5-V017H	90311		
2.4 JTD	2387	120	5	10.03-06.07	841M000, 841N000		EPBMFT5-V035H	94119	EPBMFT5-V001P	93006
2.4 JTD	2387	129	5	10.03-06.07	841G000, 841H000		EPBMFT5-V035H	94119	EPBMFT5-V001P	93006
2.4 JTD	2387	132	5	07.06-06.07	841M000		EPBMFT5-V035H	94119		
2.4 JTD	2387	136	5	07.05-06.07	936B000, 841M000		EPBMFT5-V035H	94119		
2.5 V6 24V	2492	140	6	09.98-12.06	AR34201		EPBMFT5-V008H	93715		
3.0 V6 24V	2959	162	6	10.00-06.07	AR36101		EPBMFT5-V008H	93715		
3.0 V6 24V	2959	166	6	09.98-06.07	AR34301		EPBMFT5-V008H	93715		

4C (960_)

1.8	1742	177	4	03.13-	960A1000		EPBMFT4-V061H	94528		
-----	------	-----	---	--------	----------	--	---------------	-------	--	--

4C SPIDER (961_)

1.8	1742	177	4	10.14-	960A1000		EPBMFT4-V061H	94528		
-----	------	-----	---	--------	----------	--	---------------	-------	--	--

BRERA (939_)

1.8 TBi	1742	147	4	05.09-06.10	939B1000		EPBMFT4-V061H	94528		
2.0 JTDM	1956	120	4	03.08-06.10	844A2000		EPBMFT4-V004H	90957		
2.0 JTDM	1956	125	4	05.09-06.10	939B3000		EPBMFT4-V004H	90957		
2.2 JTS	2198	136	4	01.06-05.11	939A5000		EPBMFT5-V020H	90244		
2.4 JTDM 20V	2387	147	5	01.06-03.11	939A3000		EPBMFN4-V020H	90971		
2.4 JTDM 20V	2387	154	5	05.07-03.11	939A9000		EPBMFN4-V020H	90971		
3.2 JTS Q4	3195	191	6	04.06-05.11	939A0000		EPBMFT5-V001P	93006		

GIULIETTA (940_)

1.4 TB	1368	110	4	09.14-	940A2000, 940C2000		EPBMFT4-V004H	90957		
1.4 TB	1368	120	4	04.10-	955A8000		EPBMFT4-V004H	90957		
1.4 TB	1368	125	4	04.10-	940A2000		EPBMFT4-V004H	90957		
1.6 JTDM	1598	77	4	04.10-02.16	940A3000		EPBMFT4-V004H	90957		
1.6 JTDM	1598	85	4	09.15-	940C5000		EPBMFT4-V004H	90957		
1.6 JTDM	1598	88	4	02.15-	940C5000, 940C1000		EPBMFT4-V004H	90957		
1.8 TBi	1742	169	4	04.10-09.13	940A1000		EPBMFT4-V061H	94528		
1.8 TBi	1742	173	4	04.10-02.16	940A1000		EPBMFT4-V061H	94528		
1.8	1742	173	4	04.11-02.16	940A1000		EPBMFT4-V061H	94528		
1.8 TBi	1742	177	4	09.13-	960A1000, 940B2000	; Euro5; Euro6	EPBMFT4-V061H	94528		
2.0 JTDM	1956	100	4	04.10-02.16	940A8000, 940B6000, 940C4000		EPBMFT4-V004H	90957		
2.0 JTDM	1956	103	4	04.10-	940A5000, 940C3000		EPBMFT4-V004H	90957		
2.0 JTDM	1956	110	4	08.13-	940B5000, 940C3000		EPBMFT4-V004H	90957		
2.0 JTDM	1956	120	4	04.10-	940A7000, 940B9000		EPBMFT4-V004H	90957		



MAF

 e kW
C
Y
I

Type-N°

Stock-N°

 Plug In
Alternative
Type-N°

 Plug In
Alternative

ALFA ROMEO
GIULIETTA (940_)

2.0 JTDM	1956	125	4	04.10-	940A4000, 940B4000		EPBMFT4-V004H	90957		
2.0 JTDM	1956	129	4	11.13-	940B4000		EPBMFT4-V004H	90957		

GT (937_)

1.9 JTD	1910	110	4	11.03-09.10	937A5000	Euro4	EPBMFN4-V017H	96226		
1.9 JTD	1910	110	4	04.04-09.10	937A5000	; Equip.Var.:M15; Euro3	EPBMFT5-V039H	90466		
1.9 JTD	1910	125	4	05.08-09.10	937A6000		EPBMFN4-V017H	96226		

GTV (916_)

1.8 16V	1747	106	4	05.98-10.05	AR32201		EPBMFT5-V017H	90311		
2.0 T.SPARK 16V	1970	110	4	06.95-10.05	AR32310		EPBMFT5-V017H	90311		
2.0 T.SPARK 16V	1970	110	4	09.98-10.05	AR16201		EPBMFN4-V017H	96226		
3.0 V6 24V	2959	162	6	01.98-10.00	AR16102		EPBMFT5-V008H	93715		

MITO (955_)

1.3 MultiJet	1248	59	4	12.13-	199B8000		EPBMFT4-V004H	90957		
1.3 MultiJet	1248	62	4	01.11-	199B4000		EPBMFT4-V004H	90957		
1.3 MultiJet	1248	66	4	08.08-08.10	199A3000		EPBMFT4-V004H	90957		
1.3 MultiJet	1248	66	4	08.08-08.10	199A3000	Euro4	EPBMFN4-V017H	96226		
1.3 MultiJet	1248	70	4	09.09-06.10	199B1000, 330A1000		EPBMFN4-V017H	96226		
1.3 MultiJet	1248	70	4	07.10-12.18	199B1000, 330A1000		EPBMFT4-V004H	90957		
1.6 JTDM	1598	85	4	08.08-	955A4000		EPBMFT4-V004H	90957		
1.6 JTDM	1598	85	4	08.08-	955A4000		EPBMFT4-V004H	90957		
1.6 JTDM	1598	88	4	08.08-	198A2000		EPBMFT4-V004H	90957		
1.6 JTDM	1598	88	4	08.08-	955A3000		EPBMFT4-V004H	90957		
1.6 JTDM	1598	88	4	08.08-	955A3000		EPBMFT4-V004H	90957		

SPIDER (916_)

1.8 16V	1747	106	4	05.98-04.05	AR32201		EPBMFT5-V017H	90311		
2.0 T.SPARK 16V	1970	110	4	06.95-04.05	AR32310		EPBMFT5-V017H	90311		
2.0 T.SPARK 16V	1970	114	4	05.98-08.00	AR32301		EPBMFT5-V017H	90311		
2.0 T.SPARK 16V	1970	114	4	05.98-08.00	AR32301		EPBMFN4-V017H	96226		

SPIDER (939_)

1.8 TBi	1742	147	4	05.09-03.11	939B1000		EPBMFT4-V061H	94528		
2.0 JTDM	1956	120	4	04.09-03.11	844A2000		EPBMFT4-V004H	90957		
2.2 JTS	2198	136	4	03.06-03.11	939A5000		EPBMFT5-V020H	90244		
2.4 JTDM	2387	147	5	03.06-03.11	939A3000		EPBMFN4-V020H	90971		
2.4 JTDM	2387	154	5	03.08-03.11	939A3000		EPBMFN4-V020H	90971		
3.2 JTS Q4	3195	191	6	03.07-03.11	939A0000		EPBMFT5-V001P	93006		

ALPINA
ROADSTER V8 (E52)

4.8 V8	4837	280	8	06.02-10.03	M62B48		EPBMFT5-D060H	95878		
--------	------	-----	---	-------------	--------	--	---------------	-------	--	--



MAF



l kW
C
Y
I



Type-N°

Stock-N°

Plug In
Alternative
Type-N°

Plug In
Subtype

AUDI

100 (4A2, C4, 4A5)

2.8 E	2771	128	6	12.90-07.94	AAH		Chass.>4AP022307	EPBMWN3-A007H	93658		
2.8 E quattro	2771	128	6	12.90-07.94	AAH		Chass.>4AP022307	EPBMWN3-A007H	93658		

80 B4 (8C5, 8C2, 8G7)

1.8	1781	92	4	04.97-08.00	ADR			EPBMWN3-A016H	93176		
1.9 TDI	1896	66	4	09.91-01.96	1Z		Chass.H	EPBMWN6-D029H	90628		
2.6	2598	110	6	06.93-08.00	ABC		Chass.>8BP003344	EPBMWN3-A007H	93658		
2.8	2771	128	6	11.92-08.00	AAH		Chass.>8BP003344	EPBMWN3-A007H	93658		
2.8 quattro	2771	128	6	09.91-01.96	AAH, AFC		Chass.>8CP191968	EPBMWN3-A007H	93658		

A1 (8X1, 8XK, 8XA, 8XF)

1.6 TDI	1598	66	4	03.11-04.15	CAYB			EPBMWT3-D024H	91171		
2.0 TDI	1968	100	4	05.12-04.15	CFHB			EPBMFN4-V008H	95035		
2.0 TDI	1968	105	4	09.11-04.15	CFHD			EPBMFN4-V008H	95035		
2.0 TFSI quattro	1984	188	4	03.12-11.12	CDLH			EPBMWT5-A027H	96756		

A2 (8Z0)

1.2 TDI	1191	45	3	03.01-08.05	ANY			EPBMFT5-D014H	95484		
1.4 TDI	1422	55	3	02.00-08.05	AMF			EPBMFT5-D014H	95484	EPBMFT5-D005P	90557
1.4 TDI	1422	55	3	02.00-08.05	BHC			EPBMFT5-D054H	94591	EPBMFT5-D005P	90557
1.4 TDI	1422	66	3	11.03-08.05	ATL			EPBMFT5-D054H	94591	EPBMFT5-D005P	90557
1.6 FSI	1598	81	4	05.02-08.05	BAD			EPBMFT5-D014H	95484		

A3 (8L1)

1.6	1595	74	4	09.96-07.97	AEH		Chass.<8LV200000	EPBMWN3-A016H	93176		
1.6	1595	74	4	08.97-05.03	AEH, AKL, APF		; Chass.>8LW000001	EPBMWT4-D014H	93236		
1.6	1595	75	4	08.00-05.03	AVU, BFQ			EPBMWT4-D014H	93236		
1.8	1781	92	4	09.96-05.03	AGN, APG		; Chass.>8LW000001	EPBMFT5-D005P	90557		
1.8	1781	92	4	09.96-07.97	AGN		Chass.<8LV200000	EPBMWN3-A016H	93176		
1.8 T	1781	110	4	12.96-05.03	ARZ, AQA			EPBMFN5-D016H	96999	EPBMFN5-D002P	91609
1.8 T quattro	1781	110	4	09.00-05.03	ARX			EPBMFN5-D016H	96999	EPBMFN5-D002P	91609
1.8 T	1781	132	4	12.98-08.00	AUQ, APP, AJQ			EPBMFN5-D016H	96999	EPBMFN5-D002P	91609
1.8 T quattro	1781	132	4	10.98-08.00	AJQ			EPBMFN5-D016H	96999	EPBMFN5-D002P	91609
1.8 T quattro	1781	132	4	09.00-05.03	ARY			EPBMFN5-D012H	96277	EPBMFN5-D002P	91609
S3 quattro	1781	154	4	03.99-04.02	AMK			EPBMFN5-D021H	90140		
S3 quattro	1781	154	4	03.99-08.00	APY			EPBMFN5-D023H	97946	EPBMFN5-D002P	91609
S3 quattro	1781	165	4	10.01-05.03	BAM			EPBMFN5-D021H	90140		
1.9 TDI	1896	66	4	09.96-06.01	AGR, ALH		Chass.>8LX000001	EPBMFN5-D005H	92204	EPBMFN5-D002P	91609
1.9 TDI	1896	74	4	10.00-05.03	ATD, AXR		Chass.>8L2040001	EPBMFN5-D003H	95299	EPBMFN5-D002P	91609
1.9 TDI	1896	74	4	10.00-05.03	ATD		Chass.<8L2040000	EPBMFN5-D005H	92204	EPBMFN5-D002P	91609
1.9 TDI	1896	81	4	08.97-07.01	AHF, ASV		Chass.>8LX000001; Chass.<8L2040000	EPBMFN5-D005H	92204	EPBMFN5-D002P	91609
1.9 TDI	1896	81	4	08.97-07.01	AHF		Chass.<8LW150000	EPBMWN6-D029H	90628		
1.9 TDI	1896	96	4	08.00-04.02	ASZ		Chass.<8L2105000	EPBMFN5-D013H	96315	EPBMFN5-D002P	91609
1.9 TDI quattro	1896	96	4	08.00-04.02	ASZ		Chass.<8L2105000	EPBMFN5-D013H	96315	EPBMFN5-D002P	91609
1.9 TDI	1896	96	4	04.02-05.03	ASZ		Chass.>8L2105001	EPBMFN5-D002P	91609		
1.9 TDI quattro	1896	96	4	04.02-05.03	ASZ		Chass.>8L2105001	EPBMFN5-D002P	91609		



MAF



l kW
C
Y
I



Type-N°

Stock-N°

Plug In
Alternative
Type-N°

Plug In
Subtype

AUDI

A3 (8P1, 8PA, 8P7)

1.6 TDI	1598	66	4	05.09-03.13	CAYB	Chass.<8PZD250000	EPBMWT3-D024H	91171		
1.6 TDI	1598	77	4	05.09-05.13	CAYC		EPBMFN5-D001H	95207		
1.8 TFSI	1798	118	4	11.06-05.13	CDA A		EPBMWT5-A027H	96756		
1.8 TFSI	1798	118	4	04.08-05.13	BZB, BYT		EPBMWN5-D027H	91976		
1.8 TFSI quattro	1798	118	4	07.08-03.13	CDA A		EPBMWT5-A027H	96756		
1.9 TDI	1896	77	4	09.04-05.10	BKC, BLS, BXE		EPBMFN5-D003H	95299		
2.0 TDI quattro	1968	100	4	05.03-06.08	AZV		EPBMFN5-D002H	91692	EPBMFN5-D002P	91609
2.0 TDI	1968	100	4	09.04-06.08	AZV		EPBMFN5-D002H	91692	EPBMFN5-D002P	91609
2.0 TDI	1968	100	4	04.08-05.13	CBAA, CFFA		EPBMFN5-D001H	95207		
2.0 TDI 16V	1968	103	4	05.03-08.12	CBAB		EPBMFN5-D001H	95207		
2.0 TDI 16V	1968	103	4	05.03-08.12	CFFB, CLJA		EPBMFN4-V008H	95035		
2.0 TDI 16V	1968	103	4	09.04-06.08	BKD		EPBMFN5-D002H	91692	EPBMFN5-D002P	91609
2.0 TDI 16V quattro	1968	103	4	11.04-06.08	BKD		EPBMFN5-D002H	91692	EPBMFN5-D002P	91609
2.0 TDI 16V quattro	1968	103	4	08.04-08.12	CBAB		EPBMFN5-D001H	95207		
2.0 TDI	1968	103	4	06.05-06.08	BMM		EPBMFN5-D002H	91692	EPBMFN5-D002P	91609
2.0 TDI quattro	1968	103	4	01.06-06.08	BMM		EPBMFN5-D002H	91692		
2.0 TDI	1968	103	4	04.08-05.13	CBAB, CFFB		EPBMFN5-D001H	95207		
2.0 TDI	1968	120	4	06.06-06.08	BUY		EPBMFN5-D002H	91692		
2.0 TDI	1968	125	4	03.06-06.08	BMN		EPBMFN5-D002H	91692	EPBMFN5-D002P	91609
2.0 TDI quattro	1968	125	4	03.06-06.08	BMN		EPBMFN5-D002H	91692	EPBMFN5-D002P	91609
2.0 TDI quattro	1968	125	4	03.06-08.12	CBBB		EPBMFN5-D001H	95207		
2.0 TDI quattro	1968	125	4	03.06-08.12	CFGB		EPBMFN4-V008H	95035		
2.0 TFSI	1984	147	4	09.04-03.13	BPY, AXX, BWA		EPBMWN5-D003D	94436		
2.0 TFSI	1984	147	4	09.04-03.13	CBFA, CAWB		EPBMWN5-D027H	91976		
2.0 TFSI quattro	1984	147	4	09.04-03.13	CCZA		EPBMWT5-A027H	96756		
2.0 TFSI	1984	147	4	04.08-05.13	CCZA		EPBMWT5-A027H	96756		
S3 quattro	1984	188	4	02.07-08.12	BZC, CDLC		EPBMWN5-D003D	94436		
S3 quattro	1984	195	4	06.08-03.13	BHZ		EPBMWN5-D003D	94436		
3.2 V6 quattro	3189	184	6	07.03-05.09	BDB, BMJ, BUB		EPBMFT5-D038H	96961		

A3 (8V1, 8VK, 8V7, 8VE, 8VS, 8VM, 8VA, 8VF)

2.0 TDI	1968	81	4	01.13-	CRFA		EPBMFN4-V008H	95035		
2.0 TDI	1968	100	4	05.13-	CRBD, CRLC		EPBMFN4-V008H	95035		
2.0 TDI	1968	105	4	03.13-	CRFC		EPBMFN4-V008H	95035		
2.0 TDI	1968	110	4	04.12-	CRBC, CRLB, CRUA, DEJA, DCYA, DBGA, DFGA		EPBMFN4-V008H	95035		
2.0 TDI quattro	1968	110	4	02.13-	CRBC, CRLB, DCYA		EPBMFN4-V008H	95035		
35 TDI	1968	110	4	07.18-	DFGA		EPBMFN4-V008H	95035		
2.0 TDI	1968	135	4	05.13-	CUNA		EPBMFN4-V008H	95035		
2.0 TDI quattro	1968	135	4	05.13-07.18	CUNA, DGCA		EPBMFN4-V008H	95035		

A4 ALLROAD B8 (8KH)

2.0 TDI quattro	1968	100	4	09.09-05.16	CAGB		EPBMFN5-D001H	95207		
2.0 TDI quattro	1968	100	4	09.09-05.16	CJCB		EPBMFN4-V008H	95035		
2.0 TDI quattro	1968	105	4	09.09-05.16	CAGA		EPBMFN5-D001H	95207		
2.0 TDI quattro	1968	105	4	09.09-05.16	CJCA		EPBMFN4-V008H	95035		
2.0 TDI quattro	1968	110	4	05.13-05.16	CJCD, CSUA		EPBMFN4-V008H	95035		



MAF



l kW
C
Y
I



Type-N°

Stock-N°

Plug In
Alternative
Type-N°

Plug In
Stock-N°

AUDI

A4 ALLROAD B8 (8KH)

2.0 TDI quattro	1968	120	4	04.09-05.16	CAHB		EPBMFN5-D001H	95207		
2.0 TDI quattro	1968	120	4	04.09-05.16	CGLD, CNHC		EPBMFN4-V008H	95035		
2.0 TDI quattro	1968	125	4	04.09-05.16	CAHA		EPBMFN5-D001H	95207		
2.0 TDI quattro	1968	130	4	11.11-05.16	CGLC		EPBMFN4-V008H	95035		
2.0 TDI quattro	1968	140	4	09.13-05.16	CNHA		EPBMFN4-V008H	95035		
2.0 TFSI quattro	1984	155	4	04.09-05.16	CDNC, CPMA		EPBMWT5-A027H	96756		
2.0 TFSI quattro	1984	162	4	05.13-05.16	CPMB		EPBMWT5-A027H	96756		
3.0 TDI quattro	2967	176	6	04.09-01.12	CCWA	OE 059906461N	EPBMWT5-A025H	93777		
3.0 TDI quattro	2967	176	6	04.09-01.12	CCWA	OE 420133471	EPBMWT5-V013D	92480		
3.0 TDI quattro	2967	180	6	01.12-05.16	CDUC, CKVB, CKVC	OE 059906461N	EPBMWT5-A025H	93777		

A4 B5 (8D2, 8D5)

1.6	1595	74	4	07.96-12.97	AHL, ADP	Chass.>8DV000001; Chass.<8DW104600	EPBMWN3-A016H	93176		
1.6	1595	74	4	01.98-09.01	ANA, ARM, AHL	; Chass.>8DW104601	EPBMWT4-D014H	93236		
1.6	1595	75	4	07.00-09.01	ALZ		EPBMWT4-D014H	93236		
1.8	1781	85	4	07.96-12.98	AFY	Chass.>8DV000001	EPBMWN3-A016H	93176		
1.8 quattro	1781	85	4	07.96-12.98	AFY	Chass.>8DV000001	EPBMWN3-A016H	93176		
1.8	1781	92	4	07.96-04.99	ADR	Chass.>8DV000001; Chass.<8DW104600	EPBMWN3-A016H	93176		
1.8 quattro	1781	92	4	07.96-04.99	ADR	Chass.>8DV000001; Chass.<8DW104600	EPBMWN3-A016H	93176		
1.8 quattro	1781	92	4	01.96-09.01	ARG, APT, ADR		EPBMFN5-D018H	91462		
1.8	1781	92	4	02.99-09.01	ARG, APT, AVV		EPBMFN5-D018H	91462	EPBMFN5-D002P	91609
1.8 T	1781	110	4	01.99-09.01	APU, ANB		EPBMFN5-D016H	96999	EPBMFN5-D002P	91609
1.8 T quattro	1781	110	4	01.99-09.01	APU, ANB		EPBMFN5-D016H	96999	EPBMFN5-D002P	91609
1.8 T	1781	110	4	06.00-09.01	AWT		EPBMFN5-D012H	96277	EPBMFN5-D002P	91609
1.8 T quattro	1781	110	4	06.00-09.01	AWT		EPBMFN5-D012H	96277	EPBMFN5-D002P	91609
1.8 T	1781	125	4	05.00-09.00	AMB		EPBMFN5-D012H	96277		
1.9 TDI	1896	55	4	12.95-11.00	AFF		EPBMFN5-D015H	90376		
1.9 TDI	1896	66	4	01.95-09.01	AHU, AHH		EPBMFN5-D015H	90376	EPBMFN5-D002P	91609
1.9 DUO	1896	66	4	03.98-09.01	AHU		EPBMFN5-D015H	90376		
1.9 TDI	1896	81	4	02.96-06.99	AFN		EPBMWN6-D029H	90628		
1.9 TDI quattro	1896	81	4	09.96-09.01	AFN, AVG		EPBMFN5-D015H	90376		
1.9 TDI	1896	81	4	06.99-	AFN	Chass.<8D1200000	EPBMFN5-D015H	90376	EPBMFN5-D002P	91609
1.9 TDI	1896	85	4	03.00-09.01	AJM		EPBMFN5-D015H	90376	EPBMFN5-D002P	91609
1.9 TDI quattro	1896	85	4	03.00-09.01	AJM, ATJ		EPBMFN5-D015H	90376		
2.4	2393	120	6	08.97-07.98	AJG		EPBMWN3-A021H	93365		
2.4	2393	120	6	02.99-06.00	APZ		EPBMWN4-D018H	96313		
2.4	2393	121	6	08.97-07.98	AGA, ALF		EPBMWN3-A021H	93365		
2.4 quattro	2393	121	6	08.97-07.98	AGA, ALF		EPBMWN3-A021H	93365		
2.4 quattro	2393	121	6	02.99-06.00	ARJ, APS, AML		EPBMWN4-D018H	96313		
2.5 TDI	2496	110	6	09.97-09.01	AKN, AFB	; Chass.<8DX400000	EPBMFT5-D045H	95253	EPBMFT5-D005P	90557
2.5 TDI	2496	110	6	09.97-09.01	AKN	; Chass.>8DY000001	EPBMFT5-D032H	91598	EPBMFT5-D005P	90557
2.5 TDI quattro	2496	110	6	09.97-11.00	AFB, AKN		EPBMFT5-D032H	91598		
S4 quattro	2671	195	6	09.97-09.01	AGB, AZB	; Chass.<8DY300000	EPBMFT5-D024H	93373		



MAF



l kW
C
Y
I



Type-N°

Stock-N°

Plug In
Alternative
Type-N°

Plug In
stock-N°

AUDI

A4 B5 (8D2, 8D5)

2.8 quattro	2771	128	6	01.95-07.97	AAH		EPBMWN3-A007H	93658		
2.8	2771	128	6	03.96-09.96	AAH		EPBMWN3-A007H	93658		
2.8	2771	142	6	10.96-09.01	ACK	Chass.<8DV205000	EPBMWN3-A007H	93658		
2.8 quattro	2771	142	6	10.96-09.01	ACK	Chass.<8DV205000	EPBMWN3-A007H	93658		
2.8	2771	142	6	04.97-12.98	ACK, ALG	Chass.>8DV205001	EPBMWN3-A021H	93365		
2.8 quattro	2771	142	6	04.97-12.98	ACK, ALG	Chass.>8DV205001	EPBMWN3-A021H	93365		
2.8 quattro	2771	142	6	02.99-06.00	AQD, APR		EPBMWN4-D018H	96313		

A4 B6 (8E2, 8E5, 8H7)

1.6	1595	75	4	09.01-12.04	ALZ		EPBMWT4-D014H	93236		
1.8 T quattro	1781	110	4	11.00-07.02	AVJ		EPBMFN5-D012H	96277		
1.8 T	1781	110	4	09.01-07.02	AVJ		EPBMFN5-D012H	96277	EPBMFN5-D002P	91609
1.8 T	1781	120	4	07.02-03.09	BFB		EPBMFN5-D012H	96277		
1.8 T quattro	1781	120	4	05.03-03.09	BFB		EPBMFN5-D012H	96277		
1.8 T	1781	125	4	07.01-12.04	AMB		EPBMFN5-D012H	96277		
1.8 T quattro	1781	125	4	07.01-12.04	AMB		EPBMFN5-D012H	96277		
1.8 T	1781	140	4	11.02-12.04	BEX		EPBMFN5-D012H	96277	EPBMFN5-D002P	91609
1.8 T quattro	1781	140	4	11.02-12.04	BEX		EPBMFN5-D012H	96277		
1.9 TDI	1896	74	4	05.01-12.04	AVB	Chass.<8E2120000	EPBMFN5-D005H	92204	EPBMFN5-D002P	91609
1.9 TDI	1896	74	4	05.01-12.04	AVB	Chass.>8E2120001	EPBMFN5-D003H	95299	EPBMFN5-D002P	91609
1.9 TDI	1896	85	4	06.04-12.04	BKE		EPBMFN5-D002H	91692		
1.9 TDI	1896	96	4	09.01-12.04	AVF, AWX	Chass.<8E1080000	EPBMFN5-D013H	96315	EPBMFN5-D002P	91609
1.9 TDI	1896	96	4	09.01-12.04	AVF, AWX	Chass.>8E2000001	EPBMFN5-D002H	91692	EPBMFN5-D002P	91609
1.9 TDI quattro	1896	96	4	11.01-12.04	AVF	Chass.<8E1080000	EPBMFN5-D013H	96315	EPBMFN5-D002P	91609
1.9 TDI quattro	1896	96	4	11.01-12.04	AVF	Chass.>8E2000001	EPBMFN5-D002H	91692	EPBMFN5-D002P	91609
2.0	1984	96	4	09.01-12.05	ALT		EPBMFT5-D028H	93297	EPBMFT5-D005P	90557
2.0 FSI	1984	110	4	07.02-12.04	AWA		EPBMFT5-D028H	93297	EPBMFT5-D005P	90557
2.4	2393	120	6	04.02-12.05	AMM		EPBMWN4-D018H	96313		
2.4	2393	125	6	04.02-12.05	BDV		EPBMWN4-D018H	96313		
2.5 TDI	2496	114	6	08.01-07.02	AYM		EPBMWN5-D014H	96884		
2.5 TDI	2496	120	6	07.02-12.04	BCZ, BDG, BFC		EPBMWN5-D014H	96884		
2.5 TDI quattro	2496	132	6	09.01-12.04	AKE, BAU, BDH		EPBMWN5-D014H	96884		

A4 B7 (8EC, 8ED, 8HE)

1.6	1595	75	4	11.04-06.08	ALZ		EPBMWT4-D014H	93236		
1.8 T	1781	120	4	11.04-06.08	BFB		EPBMFN5-D012H	96277		
1.8 T quattro	1781	120	4	11.04-06.08	BFB		EPBMFN5-D012H	96277		
1.9 TDI	1896	85	4	11.04-06.08	BKE, BRB		EPBMFN5-D002H	91692	EPBMFN5-D002P	91609
2.0 TDI	1968	89	4	09.05-09.06	BVG		EPBMFN5-D002H	91692	EPBMFN5-D002P	91609
2.0 TDI	1968	93	4	11.05-11.06	BVF		EPBMFN5-D002H	91692	EPBMFN5-D002P	91609
2.0 TDI	1968	100	4	11.04-03.09	BRC, BNA		EPBMFN5-D002H	91692		
2.0 TDI	1968	103	4	11.04-03.09	BPW		EPBMFN5-D002H	91692	EPBMFN5-D002P	91609
2.0 TDI 16V	1968	103	4	11.04-06.08	BLB, BRE		EPBMFN5-D002H	91692	EPBMFN5-D002P	91609
2.0 TDI quattro	1968	103	4	01.06-06.08	BPW		EPBMFN5-D002H	91692		
2.0 TDI	1968	120	4	06.06-06.08	BVA		EPBMFN5-D002H	91692		
2.0 TDI quattro	1968	120	4	06.06-06.08	BVA		EPBMFN5-D002H	91692		





AUDI

A4 B7 (8EC, 8ED, 8HE)

2.0 TDI	1968	125	4	06.06-06.08	BRD		EPBMFN5-D002H	91692	EPBMFN5-D002P	91609
2.0 TDI quattro	1968	125	4	06.06-06.08	BRD		EPBMFN5-D002H	91692		
2.0	1984	96	4	11.04-06.08	ALT		EPBMFT5-D028H	93297		
2.0 TFSI	1984	147	4	11.04-06.08	BGB, BPG, BWE, BWT		EPBMWN5-D006H	92698		
2.0 TFSI quattro	1984	147	4	11.04-06.08	BGB, BPG, BWE, BWT		EPBMWN5-D006H	92698		
2.0 TFSI 16V	1984	147	4	01.06-03.09	BWE, BWT		EPBMWN5-D006H	92698		
2.5 TDI	2496	120	6	11.04-05.06	BDG		EPBMWN5-D014H	96884		
2.7 TDi	2698	120	6	03.06-03.08	BSG		EPBMFN5-D033H	93804		
2.7 TDI	2698	132	6	01.06-06.08	BPP		EPBMFN5-D033H	93804		
3.0 TDI quattro	2967	150	6	01.06-03.09	BKN		EPBMFN5-D033H	93804		
3.0 TDI quattro	2967	171	6	01.06-03.09	ASB		EPBMFN5-D033H	93804		
RS4 quattro	4163	309	8	06.06-01.08	BNS		EPBMFT5-D005P	90557		

A4 B8 (8K2, 8K5)

1.8 TFSI	1798	88	4	01.08-12.15	CABA, CDHA		EPBMWT5-A027H	96756		
1.8 TFSI	1798	118	4	11.07-03.12	CABB, CDHB		EPBMWT5-A027H	96756		
1.8 TFSI quattro	1798	118	4	09.08-03.12	CDHB		EPBMWT5-A027H	96756		
2.0 TDI	1968	88	4	06.08-12.15	CAGC		EPBMFN5-D001H	95207		
2.0 TDI	1968	88	4	06.08-12.15	CJCC		EPBMFN4-V008H	95035		
2.0 TDI	1968	100	4	04.08-12.15	CAGB		EPBMFN5-D001H	95207		
2.0 TDI	1968	100	4	04.08-12.15	CJCB, CSUB		EPBMFN4-V008H	95035		
2.0 TDI	1968	105	4	04.08-12.15	CAGA, CMEA		EPBMFN5-D001H	95207		
2.0 TDI	1968	105	4	04.08-12.15	CJCA, CMFA		EPBMFN4-V008H	95035		
2.0 TDI quattro	1968	105	4	04.08-12.15	CAGA		EPBMFN5-D001H	95207		
2.0 TDI quattro	1968	105	4	04.08-12.15	CJCA		EPBMFN4-V008H	95035		
2.0 TDI	1968	110	4	05.13-12.15	CJCD, CMFB, CSUA		EPBMFN4-V008H	95035		
2.0 TDI quattro	1968	110	4	05.13-12.15	CJCD, CSUA		EPBMFN4-V008H	95035		
2.0 TDI	1968	120	4	08.08-12.15	CAHB, CNHC		EPBMFN5-D001H	95207		
2.0 TDI	1968	120	4	08.08-12.15	CGLD		EPBMFN4-V008H	95035		
2.0 TDI	1968	125	4	01.08-03.12	CAHA		EPBMFN5-D001H	95207		
2.0 TDI quattro	1968	125	4	01.08-03.12	CAHA		EPBMFN5-D001H	95207		
2.0 TDI	1968	130	4	11.11-12.15	CGLC, CMGB		EPBMFN4-V008H	95035		
2.0 TDI quattro	1968	130	4	11.11-12.15	CGLC		EPBMFN4-V008H	95035		
2.0 TDI	1968	140	4	09.13-12.15	CNHA		EPBMFN4-V008H	95035		
2.0 TDI quattro	1968	140	4	09.13-12.15	CNHA		EPBMFN4-V008H	95035		
2.0 TFSI	1984	132	4	06.08-12.15	CAEA, CDNB, CFKA		EPBMWT5-A027H	96756		
2.0 TFSI flexible fuel	1984	132	4	11.09-12.15	CFKA		EPBMWT5-A027H	96756		
2.0 TFSI flexible fuel quattro	1984	132	4	11.09-12.15	CFKA		EPBMWT5-A027H	96756		
2.0 TFSI	1984	155	4	06.08-05.13	CAEB, CDNC		EPBMWT5-A027H	96756		
2.0 TFSI quattro	1984	155	4	06.08-12.15	CAEB, CDNC, CPMA		EPBMWT5-A027H	96756		
2.7 TDI	2698	120	6	06.08-03.12	CAMB, CGKB	OE 059906461N	EPBMWT5-A025H	93777		
2.7 TDI	2698	120	6	06.08-03.12	CAMB, CGKB	OE 420133471	EPBMWT5-V013D	92480		
2.7 TDI	2698	140	6	04.08-03.12	CAMA, CGKA	OE 059906461N	EPBMWT5-A025H	93777		

MAF



l kW
C
Y
I



Type-N°

Stock-N°

Plug In
Alternative
Type-N°

Plug In
Subtype

AUDI

A4 B8 (8K2, 8K5)

2.7 TDI	2698	140	6	04.08-03.12	CAMA, CGKA	OE 420133471	EPBMWT5-V013D	92480		
3.0 TDI	2967	150	6	11.11-12.15	CLAB	OE 059906461N	EPBMWT5-A025H	93777		
3.0 TDI quattro	2967	155	6	06.08-05.10	CCWB	OE 059906461N	EPBMWT5-A025H	93777		
3.0 TDI quattro	2967	155	6	06.08-05.10	CCWB	OE 420133471	EPBMWT5-V013D	92480		
3.0 TDI quattro	2967	176	6	04.08-03.12	CAPA, CCLA, CCWA	OE 059906461N	EPBMWT5-A025H	93777		
3.0 TDI quattro	2967	176	6	04.08-03.12	CAPA, CCLA, CCWA	OE 420133471	EPBMWT5-V013D	92480		
3.0 TDI quattro	2967	180	6	11.11-12.15	CDUC, CKVB, CKVC	OE 059906461N	EPBMWT5-A025H	93777		

A4 B9 (8W2, 8WC, 8W5, 8WD)

2.0 TDI	1968	90	4	04.16-10.19	DEUC		EPBMFN4-V008H	95035		
30 TDI	1968	90	4	05.16-10.19	DEUC		EPBMFN4-V008H	95035		
2.0 TDI	1968	100	4	05.15-11.19	DEUB		EPBMFN4-V008H	95035		
2.0 TDI quattro	1968	100	4	11.16-07.18	DEUB		EPBMFN4-V008H	95035		
30 TDI Mild Hybrid	1968	100	4	07.19-	DEZB		EPBMFN4-V008H	95035		
2.0 TDI	1968	110	4	05.15-11.19	CZHA, DEUA		EPBMFN4-V008H	95035		
35 TDI	1968	110	4	08.15-10.19	DEUA		EPBMFN4-V008H	95035		
2.0 TDI quattro	1968	110	4	09.16-10.19	DEUA		EPBMFN4-V008H	95035		
35 TDI Mild Hybrid	1968	120	4	03.19-	DEZE		EPBMFN4-V008H	95035		
2.0 TDI	1968	140	4	05.15-	DESA, DETA, DFVA		EPBMFN4-V008H	95035		
40 TDI	1968	140	4	05.15-	DESA, DETA		EPBMFN4-V008H	95035		
40 TDI quattro	1968	140	4	09.15-	DETA		EPBMFN4-V008H	95035		
2.0 TDI quattro	1968	140	4	01.16-	DESA, DETA, DFVA		EPBMFN4-V008H	95035		

A4 B9 ALLROAD (8WH, 8WJ)

2.0 TDI quattro	1968	100	4	11.16-07.18	DEUB		EPBMFN4-V008H	95035		
2.0 TDI quattro	1968	110	4	09.16-10.19	DEUA		EPBMFN4-V008H	95035		
2.0 TDI quattro	1968	140	4	01.16-	DESA, DETA, DFVA		EPBMFN4-V008H	95035		

A5 (8T3, 8F7)

1.8 TFSI	1798	118	4	05.09-09.11	CDHB		EPBMWT5-A027H	96756		
1.8 TFSI	1798	125	4	10.07-01.17	CABD, CJEB		EPBMWT5-A027H	96756		
2.0 TDI	1968	105	4	10.11-05.15	CJCA		EPBMFN4-V008H	95035		
2.0 TDI	1968	110	4	05.13-01.17	CJCD, CSUA		EPBMFN4-V008H	95035		
2.0 TDI	1968	120	4	05.09-06.14	CAHB		EPBMFN5-D001H	95207		
2.0 TDI	1968	120	4	05.09-06.14	CGLD		EPBMFN4-V008H	95035		
2.0 TDI quattro	1968	125	4	08.08-03.12	CAHA		EPBMFN5-D001H	95207		
2.0 TDI	1968	125	4	05.09-03.12	CAHA		EPBMFN5-D001H	95207		
2.0 TDI	1968	130	4	10.11-01.17	CGLC		EPBMFN4-V008H	95035		
2.0 TDI quattro	1968	130	4	01.12-05.15	CGLC		EPBMFN4-V008H	95035		
2.0 TDI	1968	140	4	09.13-01.17	CNHA		EPBMFN4-V008H	95035		
2.0 TDI quattro	1968	140	4	09.13-01.17	CNHA		EPBMFN4-V008H	95035		
2.0 TFSI	1984	155	4	06.08-11.13	CDNC		EPBMWT5-A027H	96756		
2.0 TFSI quattro	1984	155	4	06.08-01.17	CAEB, CDNC		EPBMWT5-A027H	96756		
2.7 TDI	2698	120	6	09.07-03.12	CAMB, CGKB	OE 059906461N	EPBMWT5-A025H	93777		
2.7 TDI	2698	120	6	09.07-03.12	CAMB, CGKB	OE 420133471	EPBMWT5-V013D	92480		



MAF



l kW
C
Y
I



Type-Nº

Stock-Nº

Plug In
Alternative
Type-Nº

Plug In
Subtype

AUDI

A5 (8T3, 8F7)

2.7 TDI	2698	140	6	06.07-03.12	CAMA, CGKA	OE 059906461N	EPBMWT5-A025H	93777		
2.7 TDI	2698	140	6	06.07-03.12	CAMA, CGKA	OE 420133471	EPBMWT5-V013D	92480		
3.0 TDI	2967	150	6	10.11-01.17	CLAB	OE 059906461N	EPBMWT5-A025H	93777		
3.0 TDI quattro	2967	155	6	03.08-05.10	CCWB	OE 059906461N	EPBMWT5-A025H	93777		
3.0 TDI quattro	2967	155	6	03.08-05.10	CCWB	OE 420133471	EPBMWT5-V013D	92480		
3.0 TDI quattro	2967	176	6	06.07-03.12	CAPA, CCWA	OE 059906461N	EPBMWT5-A025H	93777		
3.0 TDI quattro	2967	176	6	06.07-03.12	CAPA, CCWA	OE 420133471	EPBMWT5-V013D	92480		
3.0 TDI quattro	2967	180	6	10.11-01.17	CDUC, CKVB, CKVC	OE 059906461N	EPBMWT5-A025H	93777		

A5 (F53, F5P, F57, F5E, F5A, F5F)

2.0 TDI	1968	100	4	05.17-	DEUB		EPBMFN4-V008H	95035		
2.0 TDI	1968	110	4	01.17-	CZHA, DEUA		EPBMFN4-V008H	95035		
2.0 TDI quattro	1968	110	4	05.17-	CZHA, DEUA		EPBMFN4-V008H	95035		
35 TDI	1968	110	4	05.17-	CZHA, DEUA		EPBMFN4-V008H	95035		
35 TDI	1968	110	4	01.17-	DEUA		EPBMFN4-V008H	95035		
35 TDI Mild Hybrid	1968	120	4	09.19-	DEZE		EPBMFN4-V008H	95035		
2.0 TDI	1968	140	4	07.16-	DESA, DETA		EPBMFN4-V008H	95035		
2.0 TDI quattro	1968	140	4	10.16-	DESA, DETA		EPBMFN4-V008H	95035		
40 TDI	1968	140	4	06.16-	DESA, DETA		EPBMFN4-V008H	95035		
40 TDI quattro	1968	140	4	03.17-	DETA		EPBMFN4-V008H	95035		

A5 SPORTBACK (8TA)

1.8 TFSI	1798	118	4	11.09-09.11	CDHB		EPBMWT5-A027H	96756		
2.0 TDI	1968	100	4	09.09-01.17	CAGB		EPBMFN5-D001H	95207		
2.0 TDI	1968	100	4	09.09-01.17	CJCB		EPBMFN4-V008H	95035		
2.0 TDI	1968	105	4	09.09-01.17	CAGA, CMEA		EPBMFN5-D001H	95207		
2.0 TDI	1968	105	4	09.09-01.17	CJCA, CMFA		EPBMFN4-V008H	95035		
2.0 TDI	1968	110	4	05.13-01.17	CJCD, CMFB, CSUA		EPBMFN4-V008H	95035		
2.0 TDI	1968	120	4	09.09-01.17	CAHB		EPBMFN5-D001H	95207		
2.0 TDI	1968	120	4	09.09-01.17	CGLD		EPBMFN4-V008H	95035		
2.0 TDI	1968	125	4	09.09-03.12	CAHA		EPBMFN5-D001H	95207		
2.0 TDI quattro	1968	125	4	09.09-03.12	CAHA		EPBMFN5-D001H	95207		
2.0 TDI	1968	130	4	10.11-01.17	CGLC		EPBMFN4-V008H	95035		
2.0 TDI quattro	1968	130	4	12.11-01.17	CGLC		EPBMFN4-V008H	95035		
2.0 TDI	1968	140	4	09.13-01.17	CNHA		EPBMFN4-V008H	95035		
2.0 TDI quattro	1968	140	4	09.13-01.17	CNHA		EPBMFN4-V008H	95035		
2.0 TFSI	1984	155	4	09.09-11.13	CDNC		EPBMWT5-A027H	96756		
2.0 TFSI quattro	1984	155	4	09.09-01.17	CAEB, CDNC		EPBMWT5-A027H	96756		
2.7 TDI	2698	120	6	09.09-01.17	CAMB, CGKB	OE 420133471	EPBMWT5-V013D	92480		
2.7 TDI	2698	120	6	09.09-01.17	CGKB	OE 059906461N	EPBMWT5-A025H	93777		
2.7 TDI	2698	140	6	09.09-03.12	CAMA, CGKA	OE 420133471	EPBMWT5-V013D	92480		
2.7 TDI	2698	140	6	09.09-03.12	CGKA	OE 059906461N	EPBMWT5-A025H	93777		
3.0 TDI	2967	150	6	10.11-01.17	CLAB	OE 059906461N	EPBMWT5-A025H	93777		
3.0 TDI quattro	2967	176	6	09.09-03.12	CAPA, CCWA	OE 420133471	EPBMWT5-V013D	92480		



MAF



l kW
C
Y
I



Type-N°

Stock-N°

Plug In
Alternative
Type-N°

Plug In
Subtype

AUDI

A5 SPORTBACK (8TA)

3.0 TDI quattro	2967	176	6	09.09-03.12	CCWA	OE 059906461N	EPBMWT5-A025H	93777		
3.0 TDI quattro	2967	180	6	10.11-01.17	CDUC, CKVB, CKVC	OE 059906461N	EPBMWT5-A025H	93777		

A6 C4 (4A2, 4A5)

1.9 TDI	1896	66	4	06.94-10.97	1Z		EPBMWN6-D029H	90628		
2.5 TDI	2461	84	5	01.95-10.97	AAT		EPBMWN5-D014H	96884		
2.5 TDI	2461	85	5	06.94-10.97	AAT		EPBMWN5-D014H	96884		
2.5 TDI	2461	103	5	08.94-12.97	AEL		EPBMWN5-D014H	96884		
2.8	2771	128	6	06.94-10.97	AAH		EPBMWN3-A007H	93658		
2.8 quattro	2771	128	6	06.94-10.97	AAH		EPBMWN3-A007H	93658		
2.8	2771	142	6	12.95-10.97	ACK		EPBMWN3-A007H	93658		
2.8 quattro	2771	142	6	12.95-10.97	ACK		EPBMWN3-A007H	93658		

A6 C5 (4B2, 4B5, 4BH)

1.8	1781	85	4	02.98-05.00	AFY		EPBMWN3-A016H	93176		
1.8	1781	92	4	07.97-01.05	AJP, ANQ, AQE, ARH		EPBMFN5-D012H	96277		
1.8	1781	92	4	12.97-01.05	AJP		EPBMWN3-A016H	93176		
1.8	1781	92	4	12.97-01.05	AQE, ARH		EPBMFN5-D018H	91462		
1.8 T	1781	110	4	01.99-01.05	ARK, APU, ANB		EPBMFN5-D016H	96999	EPBMFN5-D002P	91609
1.8 T quattro	1781	110	4	01.99-01.05	ARK, APU, ANB		EPBMFN5-D016H	96999	EPBMFN5-D002P	91609
1.8 T	1781	110	4	05.00-01.05	AWT	Chass.<4B2013735	EPBMFN5-D012H	96277	EPBMFN5-D002P	91609
1.8 T	1781	110	4	05.00-01.05	AWT	Chass.>4B2013736	EPBMFN5-D025H	94062	EPBMFN5-D002P	91609
1.8 T quattro	1781	110	4	02.97-01.05	AWT		EPBMFN5-D012H	96277		
1.9 TDI	1896	81	4	04.97-04.01	AFN		EPBMFN5-D015H	90376	EPBMFN5-D002P	91609
1.9 TDI	1896	85	4	07.00-01.05	AJM		EPBMFN5-D002P	91609		
1.9 TDI	1896	96	4	08.01-01.05	AVF, AWX		EPBMFN5-D002H	91692	EPBMFN5-D002P	91609
2.0	1984	96	4	08.01-01.05	ALT		EPBMFT5-D028H	93297		
2.4	2393	100	6	07.98-01.05	ASM, ARN		EPBMWN4-D018H	96313		
2.4	2393	115	6	08.98-07.99	APC		EPBMWN3-A021H	93365		
2.4	2393	120	6	05.97-01.05	AJG, AMM, APZ		EPBMWN3-A021H	93365		
2.4 quattro	2393	120	6	05.97-01.99	AJG		EPBMWN3-A021H	93365		
2.4	2393	120	6	06.01-01.05	AMM		EPBMWN4-D018H	96313		
2.4	2393	121	6	04.97-01.99	AGA, ALF		EPBMWN3-A021H	93365		
2.4 quattro	2393	121	6	04.97-01.99	AGA, ALF		EPBMWN3-A021H	93365		
2.4	2393	121	6	06.00-01.05	AML		EPBMWN4-D018H	96313		
2.4 quattro	2393	121	6	06.00-01.05	AML		EPBMWN4-D018H	96313		
2.4	2393	125	6	08.01-01.05	BDV		EPBMWN4-D018H	96313		
2.4 quattro	2393	125	6	08.01-01.05	BDV		EPBMWN4-D018H	96313		
2.5 TDI	2496	110	6	07.97-05.01	AFB, AKN	Chass.<4BX200000	EPBMFT5-D045H	95253	EPBMFT5-D005P	90557
2.5 TDI	2496	110	6	07.97-05.01	AFB, AKN	Chass.>4BY000001	EPBMFT5-D032H	91598	EPBMFT5-D005P	90557
2.5 TDI quattro	2496	110	6	07.97-11.99	AFB	Chass.>4BY000001	EPBMFT5-D032H	91598	EPBMFT5-D005P	90557
2.5 TDI	2496	114	6	08.01-01.05	AYM		EPBMWN5-D014H	96884		
2.5 TDI	2496	120	6	07.02-01.05	BCZ, BDG, BFC		EPBMWN5-D014H	96884		
2.5 TDI quattro	2496	120	6	05.03-08.05	BCZ		EPBMWN5-D014H	96884		
2.5 TDI	2496	132	6	02.00-01.05	AKE		EPBMWN5-D014H	96884		



MAF



l kW
C
Y
I



Type-N°

Stock-N°

Plug In
Alternative
Type-N°

Plug In
Subtype

AUDI

A6 C5 (4B2, 4B5, 4BH)

2.5 TDI quattro	2496	132	6	02.00-01.05	AKE, BAU		EPBMWN5-D014H	96884		
2.7 T quattro	2671	169	6	12.97-01.05	AJK		EPBMFT5-D024H	93373		
2.8	2771	132	6	04.98-05.00	AGE		EPBMWN3-A021H	93365		
2.8	2771	142	6	04.97-12.98	ACK, ALG		EPBMWN3-A021H	93365		
2.8	2771	142	6	02.97-01.05	AQD, APR, AMX		EPBMWN4-D018H	96313		
2.8 quattro	2771	142	6	04.97-12.98	ACK, ALG		EPBMWN3-A021H	93365		
2.8 quattro	2771	142	6	02.97-01.05	AQD, APR, AMX		EPBMWN4-D018H	96313		
4.2 quattro	4172	220	8	06.01-01.05	ASG		EPBMFT5-D005P	90557		
RS6 quattro	4172	331	8	07.02-01.05	BCY		EPBMFN5-D021H	90140		
RS6 plus quattro	4172	353	8	04.04-01.05	BRV		EPBMFN5-D021H	90140		

A6 C6 (4F2, 4FH, 4F5)

2.0 TDI	1968	89	4	09.05-06.06	BVG		EPBMFN5-D002H	91692		
2.0 TDI	1968	100	4	06.05-11.05	BNA		EPBMFN5-D002H	91692	EPBMFN5-D002P	91609
2.0 TDI	1968	100	4	01.09-03.11	BNA, BRP, CAGB		EPBMFN5-D001H	95207		
2.0 TDI	1968	103	4	06.05-10.08	BLB, BRE		EPBMFN5-D002H	91692	EPBMFN5-D002P	91609
2.0 TDI	1968	120	4	04.09-03.11	CAHB		EPBMFN5-D001H	95207		
2.0 TDI	1968	125	4	10.08-08.11	CAHA		EPBMFN5-D001H	95207		
2.0 TFSI	1984	125	4	06.05-03.11	BPJ, BYK		EPBMWN5-D006H	92698		
2.7 TDI	2698	120	6	11.04-08.08	BSG		EPBMFN5-D033H	93804		
2.7 TDI	2698	120	6	03.05-08.11	BSG, CANB	OE 059906461N	EPBMWT5-A025H	93777		
2.7 TDI	2698	120	6	03.05-08.11	BSG, CANB	OE 420133471	EPBMWT5-V013D	92480		
2.7 TDI quattro	2698	120	6	05.06-08.11	BSG, CAND	OE 059906461N	EPBMWT5-A025H	93777		
2.7 TDI quattro	2698	120	6	05.06-08.11	BSG, CAND	OE 420133471	EPBMWT5-V013D	92480		
2.7 TDI	2698	132	6	03.05-10.08	BPP	OE 059906461N	EPBMWT5-A025H	93777		
2.7 TDI	2698	132	6	03.05-10.08	BPP	OE 420133471	EPBMWT5-V013D	92480		
2.7 TDI quattro	2698	132	6	03.06-10.08	BPP	OE 059906461N	EPBMWT5-A025H	93777		
2.7 TDI quattro	2698	132	6	03.06-10.08	BPP	OE 420133471	EPBMWT5-V013D	92480		
2.7 TDI	2698	140	6	10.08-03.11	CANA	OE 059906461N	EPBMWT5-A025H	93777		
2.7 TDI	2698	140	6	10.08-03.11	CANA	OE 420133471	EPBMWT5-V013D	92480		
2.7 TDI quattro	2698	140	6	10.08-03.11	CANC	OE 059906461N	EPBMWT5-A025H	93777		
2.7 TDI quattro	2698	140	6	10.08-03.11	CANC	OE 420133471	EPBMWT5-V013D	92480		
3.0 TDI quattro	2967	155	6	03.05-08.11	BNG, CDYB	OE 059906461N	EPBMWT5-A025H	93777		
3.0 TDI quattro	2967	155	6	03.05-08.11	BNG, CDYB	OE 420133471	EPBMWT5-V013D	92480		
3.0 TDI quattro	2967	165	6	03.05-05.06	BMK		EPBMFN5-D033H	93804		
3.0 TDI quattro	2967	171	6	05.06-10.08	ASB	OE 059906461N	EPBMWT5-A025H	93777		
3.0 TDI quattro	2967	171	6	05.06-10.08	ASB	OE 420133471	EPBMWT5-V013D	92480		
3.0 TDI quattro	2967	176	6	10.08-03.11	CDYA, CDYC	OE 059906461N	EPBMWT5-A025H	93777		
3.0 TDI quattro	2967	176	6	10.08-03.11	CDYA, CDYC	OE 420133471	EPBMWT5-V013D	92480		
4.2 quattro	4163	246	8	04.05-05.06	BAT		EPBMFT5-D005P	90557		
4.2 FSI quattro	4163	257	8	10.06-08.11	BVJ		EPBMFT5-D005P	90557		



MAF



l kW
C
Y
I



Type-N°

Stock-N°

Plug In
Alternative
Type-N°

Plug In
Subtype

AUDI

A6 C7 (4G2, 4GC, 4G5, 4GD)

2.0 TDI	1968	100	4	01.12-09.18	CGLE, CSUE, DDCA		EPBMFN4-V008H	95035		
2.0 TDI	1968	110	4	09.14-09.18	CSUD		EPBMFN4-V008H	95035		
2.0 TDI	1968	120	4	03.11-09.18	CGLD		EPBMFN4-V008H	95035		
2.0 TDI	1968	130	4	03.11-09.18	CGLC, CMGB		EPBMFN4-V008H	95035		
2.0 TDI	1968	140	4	11.13-09.18	CNHA, CZJA, DDDA		EPBMFN4-V008H	95035		
2.0 TDI quattro	1968	140	4	04.15-09.18	CNHA		EPBMFN4-V008H	95035		
2.0 TFSI	1984	132	4	05.11-09.18	CDNB		EPBMWT5-A027H	96756		
2.0 TFSI	1984	155	4	03.11-05.13	CAEB		EPBMWT5-A027H	96756		
2.0 TFSI hybrid	1984	155	4	11.11-09.18	CHJA		EPBMWT5-A027H	96756		
2.0 TFSI quattro	1984	155	4	05.12-05.13	CAEB		EPBMWT5-A027H	96756		
2.0 TFSI quattro	1984	162	4	05.13-09.18	CAED		EPBMWT5-A027H	96756		
3.0 TDI	2967	150	6	11.10-09.18	CLAB	OE 420133471	EPBMWT5-V013D	92480		
3.0 TDI	2967	150	6	05.11-09.18	CLAB	OE 059906461N	EPBMWT5-A025H	93777		
3.0 TDI quattro	2967	150	6	03.11-09.18	CLAA	OE 059906461N	EPBMWT5-A025H	93777		
3.0 TDI quattro	2967	150	6	03.11-09.18	CLAA	OE 420133471	EPBMWT5-V013D	92480		
3.0 TDI quattro	2967	180	6	03.11-09.18	CDUC, CDUD	OE 059906461N	EPBMWT5-A025H	93777		
3.0 TDI quattro	2967	180	6	03.11-09.18	CDUC, CDUD	OE 420133471	EPBMWT5-V013D	92480		

A6 C7 ALLROAD (4GH, 4GJ)

3.0 TDI quattro	2967	150	6	01.12-12.14	CLAA	OE 059906461N	EPBMWT5-A025H	93777		
-----------------	------	-----	---	-------------	------	---------------	---------------	-------	--	--

A7 SPORTBACK (4GA, 4GF)

3.0 TDI	2967	150	6	11.10-03.15	CLAB	OE 059906461N	EPBMWT5-A025H	93777		
3.0 TDI	2967	150	6	11.10-03.15	CLAB	OE 420133471	EPBMWT5-V013D	92480		
3.0 TDI quattro	2967	150	6	12.10-03.15	CLAA	OE 059906461N	EPBMWT5-A025H	93777		
3.0 TDI quattro	2967	176	6	05.13-06.17	CPNB	OE 059906461N	EPBMWT5-A025H	93777		
3.0 TDI quattro	2967	180	6	10.10-06.16	CDUC, CDUD	OE 059906461N	EPBMWT5-A025H	93777		
3.0 TDI quattro	2967	180	6	10.10-06.16	CDUC, CDUD	OE 420133471	EPBMWT5-V013D	92480		

A8 (4E2, 4E8)

2.5 TDI	2496	110	6	01.97-04.00	AKN, AFB		EPBMFT5-D045H	95253		
2.5 TDI quattro	2496	110	6	07.97-04.00	AKN, AFB		EPBMFT5-D045H	95253		
2.5 TDI	2496	132	6	09.00-09.02	AKE		EPBMWN5-D014H	96884		
2.5 TDI quattro	2496	132	6	09.00-09.02	AKE		EPBMWN5-D014H	96884		
2.8	2771	120	6	07.95-03.96	AEJ		EPBMWN3-A007H	93658		
2.8 quattro	2771	120	6	07.95-03.96	AEJ		EPBMWN3-A007H	93658		
2.8	2771	128	6	03.94-03.96	AAH		EPBMWN3-A007H	93658		
2.8 quattro	2771	128	6	03.94-03.96	AAH		EPBMWN3-A007H	93658		
2.8	2771	142	6	04.96-09.02	ACK	Chass.<4DV011000	EPBMWN3-A007H	93658		
2.8	2771	142	6	04.96-09.02	AMX, APR, AQD		EPBMWN4-D018H	96313		
2.8 quattro	2771	142	6	04.96-09.02	ACK	Chass.<4DV011000	EPBMWN3-A007H	93658		
2.8 quattro	2771	142	6	04.96-09.02	AQD, APR, AMX		EPBMWN4-D018H	96313		
2.8	2771	142	6	04.97-12.98	ACK, ALG	Chass.>4DV011001	EPBMWN3-A021H	93365		
2.8 quattro	2771	142	6	04.97-12.98	ACK	Chass.>8DV205001	EPBMWN3-A021H	93365		



MAF



l kW
C
Y
I



Type-N°

Stock-N°

Plug In
Alternative
Type-N°

Plug In
Subtype

AUDI

A8 (4E2, 4E8)

3.0 TDI quattro	2967	155	6	11.03-07.10	BNG		EPBMFN5-D033H	93804		
3.0 TDI quattro	2967	171	6	02.04-07.10	ASB		EPBMFN5-D033H	93804		
3.3 TDI quattro	3328	165	8	06.00-09.02	AKF		EPBMFT5-D005P	90557		
3.7 quattro	3697	191	8	11.98-09.02	AKC		EPBMFT5-D005P	90557		
3.7 quattro	3697	206	8	03.03-05.06	BFL		EPBMFT5-D005P	90557		
4.2 quattro	4172	246	8	03.03-08.06	BFM		EPBMFT5-D005P	90557		

A8 D4 (4H2, 4H8, 4HC, 4HL)

2.0 TFSI hybrid	1984	155	4	02.12-11.15	CHJA	OE 420133471	EPBMWT5-V013D	92480		
3.0 TDI	2967	150	6	09.11-09.13	CLAB	OE 420133471	EPBMWT5-V013D	92480		
3.0 TDI quattro	2967	155	6	08.10-11.15	CDTB, CTBB	OE 420133471	EPBMWT5-V013D	92480		
3.0 TDI quattro	2967	176	6	11.12-06.16	CPNA	OE 420133471	EPBMWT5-V013D	92480		
3.0 TDI quattro	2967	184	6	07.10-01.18	CDTA, CDTC, CMHA	OE 420133471	EPBMWT5-V013D	92480		
3.0 TDI quattro	2967	190	6	10.13-01.18	CTBA	OE 420133471	EPBMWT5-V013D	92480		
3.0 TDI quattro	2967	193	6	05.15-01.18	CTBD	OE 420133471	EPBMWT5-V013D	92480		
3.0 TFSI quattro	2995	213	6	07.10-04.14	CGWA, CGXA, CREG	OE 420133471	EPBMWT5-V013D	92480		
3.0 TFSI quattro	2995	228	6	11.11-01.18	CGWD, CREA	OE 420133471	EPBMWT5-V013D	92480		
3.0 TFSI quattro	2995	245	6	06.10-01.18	CGXC, CMDA, CREG, CTDA, CTUB	OE 420133471	EPBMWT5-V013D	92480		

COUPE B3 (89, 8B3)

2.8	2771	128	6	09.91-12.96	AAH	Chass.>8BP004635	EPBMWN3-A007H	93658		
2.8 quattro	2771	128	6	08.91-12.96	AAH	Chass.>8BP004635	EPBMWN3-A007H	93658		

Q2 (GAB, GAG)

2.0 TDI	1968	110	4	09.16-	DFGA		EPBMFN4-V008H	95035		
2.0 TDI quattro	1968	110	4	09.16-	DFGA		EPBMFN4-V008H	95035		
35 TDI	1968	110	4	09.16-	DFGA		EPBMFN4-V008H	95035		
35 TDI quattro	1968	110	4	09.18-	DFGA		EPBMFN4-V008H	95035		
2.0 TDI quattro	1968	140	4	07.16-	DFHA		EPBMFN4-V008H	95035		

Q3 (8UB, 8UG)

2.0 TDI	1968	88	4	03.15-10.18	CUVD, DFTC		EPBMFN4-V008H	95035		
2.0 TDI	1968	100	4	09.11-10.18	CFFA, DFTB		EPBMFN4-V008H	95035		
2.0 TDI	1968	103	4	09.11-10.18	CFFB, CLJA		EPBMFN4-V008H	95035		
2.0 TDI quattro	1968	103	4	01.12-10.18	CFFB		EPBMFN4-V008H	95035		
2.0 TDI	1968	110	4	11.14-10.18	CUVC, DBBA, DFTA		EPBMFN4-V008H	95035		
2.0 TDI quattro	1968	110	4	11.14-10.18	CUVC, DFTA		EPBMFN4-V008H	95035		
2.0 TDI quattro	1968	120	4	06.11-04.15	CFGD		EPBMFN4-V008H	95035		
2.0 TDI	1968	130	4	06.11-04.15	CFGC		EPBMFN4-V008H	95035		
2.0 TDI quattro	1968	130	4	06.11-10.18	CFGC, CLLB		EPBMFN4-V008H	95035		
2.0 TDI quattro	1968	135	4	11.14-10.18	CUWA, CYLA, DFUA		EPBMFN4-V008H	95035		
2.0 TDI	1968	135	4	05.15-10.18	CUWA, DFUA		EPBMFN4-V008H	95035		
2.0 TFSI quattro	1984	125	4	06.11-04.15	CCZC		EPBMWT5-A027H	96756		
2.0 TFSI quattro	1984	155	4	06.11-04.15	CPSA		EPBMWT5-A027H	96756		

Q3 (F3B)

35 TDI	1968	110	4	09.18-	DFGA		EPBMFN4-V008H	95035		
--------	------	-----	---	--------	------	--	---------------	-------	--	--



MAF



l kW
C
Y
I



Type-N°

Stock-N°

Plug In
Alternative
Type-N°

Plug In
stock

AUDI

Q3 (F3B)

35 TDI quattro	1968	110	4	09.18-	DFGA		EPBMFN4-V008H	95035		
40 TDI quattro	1968	140	4	10.18-	DFHA		EPBMFN4-V008H	95035		

Q5 (8RB)

2.0 TDI quattro	1968	100	4	08.09-05.17	CAGB		EPBMFN5-D001H	95207		
2.0 TDI quattro	1968	100	4	08.09-05.17	CJCB, CSUB		EPBMFN4-V008H	95035		
2.0 TDI	1968	100	4	11.10-05.17	CJCB, CSUB		EPBMFN4-V008H	95035		
2.0 TDI quattro	1968	105	4	08.09-05.13	CAGA		EPBMFN5-D001H	95207		
2.0 TDI quattro	1968	105	4	08.09-05.13	CJCA		EPBMFN4-V008H	95035		
2.0 TDI	1968	105	4	11.10-05.13	CJCA		EPBMFN4-V008H	95035		
2.0 TDI	1968	110	4	05.13-05.17	CJCD, CSUA		EPBMFN4-V008H	95035		
2.0 TDI quattro	1968	110	4	05.13-05.17	CJCD, CSUA		EPBMFN4-V008H	95035		
2.0 TDI quattro	1968	120	4	11.08-05.17	CAHB		EPBMFN5-D001H	95207		
2.0 TDI quattro	1968	120	4	11.08-05.17	CGLA, CGLD, CNHC		EPBMFN4-V008H	95035		
2.0 TDI quattro	1968	125	4	11.08-09.12	CAHA		EPBMFN5-D001H	95207		
2.0 TDI quattro	1968	125	4	11.08-09.12	CGLB, CMGA		EPBMFN4-V008H	95035		
2.0 TDI quattro	1968	130	4	06.12-05.17	CGLC, CMGB		EPBMFN4-V008H	95035		
2.0 TDI quattro	1968	140	4	11.13-05.17	CNHA		EPBMFN4-V008H	95035		
2.0 TDI	1968	140	4	09.15-05.17	CNHA		EPBMFN4-V008H	95035		
2.0 TFSI quattro	1984	132	4	08.09-05.17	CDNB, CNCB		EPBMWT5-A027H	96756		
2.0 TFSI quattro	1984	155	4	11.08-09.12	CAEB, CDNC, CPMA		EPBMWT5-A027H	96756		
2.0 TFSI hybrid quattro	1984	155	4	06.11-06.16	CHJA		EPBMWT5-A027H	96756		
2.0 TFSI quattro	1984	162	4	05.13-05.17	CPMB		EPBMWT5-A027H	96756		
3.0 TDI quattro	2967	155	6	11.08-09.12	CCWB	OE 059906461N	EPBMWT5-A025H	93777		
3.0 TDI quattro	2967	155	6	11.08-09.12	CCWB	OE 420133471	EPBMWT5-V013D	92480		
3.0 TDI quattro	2967	176	6	11.08-05.17	CCWA, CPNB	OE 420133471	EPBMWT5-V013D	92480		
3.0 TDI quattro	2967	176	6	11.08-05.17	CCWA	OE 059906461N	EPBMWT5-A025H	93777		
3.0 TDI quattro	2967	180	6	06.12-05.17	CDUD	OE 059906461N	EPBMWT5-A025H	93777		
3.0 TDI quattro	2967	184	6	06.12-05.17	CTBC	OE 059906461N	EPBMWT5-A025H	93777		
3.0 TDI quattro	2967	190	6	11.13-05.17	CTBA	OE 059906461N	EPBMWT5-A025H	93777		
3.2 FSI quattro	3197	199	6	11.08-12.12	CALB		EPBMWT4-D014H	93236		

Q5 (FYB, FYG)

2.0 TDI	1968	100	4	01.17-	DEUB		EPBMFN4-V008H	95035		
2.0 TDI	1968	110	4	01.17-	DEUA		EPBMFN4-V008H	95035		
2.0 TDI quattro	1968	120	4	06.16-08.18	DETB		EPBMFN4-V008H	95035		
35 TDI quattro	1968	120	4	08.18-	DETB		EPBMFN4-V008H	95035		
2.0 TDI quattro	1968	140	4	06.16-08.18	DESA, DETA		EPBMFN4-V008H	95035		
40 TDI quattro	1968	140	4	10.18-	DESA, DETA		EPBMFN4-V008H	95035		

Q7 (4LB)

3.0 TDI quattro	2967	150	6	05.10-08.15	CJGC, CJMA	OE 059906461N	EPBMWT5-A025H	93777		
3.0 TDI quattro	2967	155	6	03.06-05.10	BUN, CASB	OE 420133471	EPBMWT5-V013D	92480		
3.0 TDI quattro	2967	155	6	12.08-05.10	BUN, CASB	OE 059906461N	EPBMWT5-A025H	93777		
3.0 TDI quattro	2967	165	6	06.09-05.12	CATA	OE 059906461N	EPBMWT5-A025H	93777		





AUDI

Q7 (4LB)

3.0 TDI quattro	2967	171	6	03.06-05.08	BUG	OE 059906461N	EPBMWT5-A025H	93777		
3.0 TDI quattro	2967	171	6	03.06-05.08	BUG	OE 420133471	EPBMWT5-V013D	92480		
3.0 TDI quattro	2967	176	6	11.07-08.15	CASA, CCMA, CJGA, CNRB	OE 420133471	EPBMWT5-V013D	92480		
3.0 TDI quattro	2967	176	6	12.08-08.15	CASA, CCMA, CJGA, CNRB	OE 059906461N	EPBMWT5-A025H	93777		
3.0 TDI quattro	2967	180	6	05.11-08.15	CJGD, CLZB, CRCA	OE 059906461N	EPBMWT5-A025H	93777		
3.6 FSI quattro	3597	206	6	08.06-05.10	BHK		EPBMFT5-D040H	97032		
4.2 TDI quattro	4134	240	8	03.07-06.09	BTR		EPBMWN5-D027H	91976		
4.2 TDI quattro	4134	250	8	05.09-08.15	CCFA, CCFC		EPBMWT5-A027H	96756		
4.2 FSI quattro	4163	257	8	03.06-05.10	BAR		EPBMFT5-D005P	90557		
6.0 TDI quattro	5934	368	12	09.08-05.14	CCGA		EPBMWT5-A027H	96756		

R8 (422, 423, 427, 429)

5.2 FSI quattro	5204	386	10	02.10-07.15	BUJ, CTYA	OE 420133471	EPBMWT5-V013D	92480		
5.2 FSI quattro	5204	404	10	05.12-07.15	CTPA	OE 420133471	EPBMWT5-V013D	92480		
5.2 FSI quattro	5204	412	10	11.10-07.15	CMPA	OE 420133471	EPBMWT5-V013D	92480		
5.2 FSI quattro	5204	419	10	07.14-07.15	CTPB	OE 420133471	EPBMWT5-V013D	92480		

R8 (4S3, 4SP)

5.2 FSI quattro	5204	397	10	07.15-	CSPB	OE 420133471	EPBMWT5-V013D	92480		
5.2 FSI quattro	5204	449	10	07.15-	CSPA, DKAA	OE 420133471	EPBMWT5-V013D	92480		

TT / TT ROADSTER (8N3, 8N9)

1.8 T	1781	110	4	01.01-06.06	AUM		EPBMFN5-D012H	96277	EPBMFN5-D002P	91609
1.8 T	1781	120	4	09.05-06.06	BVP		EPBMFN5-D012H	96277		
1.8 T	1781	132	4	10.98-10.01	APP		EPBMFN5-D016H	96999	EPBMFN5-D002P	91609
1.8 T	1781	132	4	10.98-06.06	AUQ		EPBMFN5-D012H	96277		
1.8 T quattro	1781	132	4	02.00-08.00	AJQ		EPBMFN5-D016H	96999	EPBMFN5-D002P	91609
1.8 T quattro	1781	132	4	02.00-08.02	ARY		EPBMFN5-D012H	96277	EPBMFN5-D002P	91609
1.8 T	1781	140	4	09.05-06.06	BVR		EPBMFN5-D012H	96277		
1.8 T quattro	1781	140	4	09.05-06.06	BVR		EPBMFN5-D012H	96277		
1.8 T quattro	1781	165	4	10.98-08.02	APX		EPBMFN5-D023H	97946	EPBMFN5-D002P	91609
1.8 T quattro	1781	165	4	10.98-06.06	BAM		EPBMFN5-D021H	90140		
1.8 T quattro	1781	180	4	03.05-06.06	BFV		EPBMFN5-D021H	90140		
3.2 VR6 quattro	3189	184	6	07.03-06.06	BHE, BPF		EPBMFT5-D038H	96961		

TT / TT ROADSTER (8J3, 8J9)

1.8 TFSI	1798	118	4	06.08-06.14	CDAА		EPBMWT5-A027H	96756		
2.0 TDI quattro	1968	125	4	06.08-06.14	CBBB		EPBMFN5-D001H	95207		
2.0 TDI quattro	1968	125	4	06.08-06.14	CFGB		EPBMFN4-V008H	95035		
2.0 TFSI	1984	147	4	08.06-06.10	BPY, BWA		EPBMWN5-D003D	94436		
2.0 TFSI	1984	147	4	08.06-06.10	CCTA		EPBMWN5-D027H	91976		
2.0 TFSI quattro	1984	147	4	06.08-06.10	CCZA		EPBMWT5-A027H	96756		
2.0 TTS quattro	1984	195	4	05.08-06.14	CDLA, CDMA		EPBMFT5-D040H	97032		
2.0 TTS quattro	1984	200	4	05.08-06.14	CDLB		EPBMFT5-D040H	97032		
3.2 V6 quattro	3189	184	6	08.06-06.10	BUB		EPBMFT5-D038H	96961		

MAF



l kW
C
Y
I



Type-N°

Stock-N°

Plug In
Alternative
Type-N°

Plug In
stock-N°

AUDI

TT / TT ROADSTER (FV3, FV9, FVP, FVR)

2.0 TDI	1968	135	4	07.14-	CUNA		EPBMFN4-V008H	95035		
2.0 TDI quattro	1968	135	4	01.17-	CUNA		EPBMFN4-V008H	95035		

BENTLEY

BENTAYGA (4V1)

6.0	5952	447	12	10.15-	DDBB	Qty. 2	EPBMFT5-D040H	97032		
6.0	5952	467	12	03.19-	DDBB	Qty. 2	EPBMFT5-D040H	97032		

CONTINENTAL (3W_)

6.0	5998	412	12	06.03-12.11	BEB, BWR	Qty. 2	EPBMFT5-D038H	96961		
6.0 FLEX	5998	412	12	03.05-12.13	BWR	Qty. 2	EPBMFT5-D038H	96961		
6.0 AWD	5998	412	12	06.06-04.11	BEB, BWR, CKHD	Qty. 2	EPBMFT5-D038H	96961		
6.0 AWD	5998	423	12	11.10-	CKHB	Qty. 2	EPBMFT5-D038H	96961		
6.0 FLEX	5998	423	12	11.10-	CKHB	Qty. 2	EPBMFT5-D038H	96961		
6.0	5998	423	12	01.11-05.15	CKHB	Qty. 2	EPBMFT5-D038H	96961		
6.0	5998	423	12	01.11-05.15	CVAB	Qty. 2	EPBMFT5-D040H	97032		
6.0 AWD	5998	423	12	09.12-	CVAB	Qty. 2	EPBMFT5-D040H	97032		
6.0 AWD	5998	434	12	08.15-	DBDA	Qty. 2	EPBMFT5-D040H	97032		
6.0 FLEX	5998	434	12	05.15-	DBDA	Qty. 2	EPBMFT5-D040H	97032		
6.0 FLEX AWD	5998	434	12	05.15-	DBDA	Qty. 2	EPBMFT5-D040H	97032		
6.0 All-wheel Drive	5998	448	12	08.07-04.11	BWRA, CKHC	Qty. 2	EPBMFT5-D038H	96961		
6.0	5998	449	12	09.07-12.11	BWRA	Qty. 2	EPBMFT5-D038H	96961		
6.0 FLEX	5998	449	12	09.08-	BWRA, CKHC	Qty. 2	EPBMFT5-D038H	96961		
6.0 FLEX	5998	460	12	09.12-	CVAA	Qty. 2	EPBMFT5-D040H	97032		
6.0 FLEX	5998	463	12	02.08-	BWRB, CKHA	Qty. 2	EPBMFT5-D038H	96961		
6.0 FLEX AWD	5998	463	12	03.10-	CKHA	Qty. 2	EPBMFT5-D038H	96961		
6.0 AWD	5998	467	12	05.14-05.16	CVAC, DBDE	Qty. 2	EPBMFT5-D040H	97032		
6.0 FLEX	5998	467	12	05.14-	CVAC	Qty. 2	EPBMFT5-D040H	97032		
6.0 FLEX AWD	5998	467	12	05.14-	CVAC	Qty. 2	EPBMFT5-D040H	97032		
6.0	5998	467	12	05.15-	DBDE		EPBMFT5-D040H	97032		
6.0	5998	472	12	05.16-	DBDD	Qty. 2	EPBMFT5-D040H	97032		
6.0 AWD	5998	472	12	11.17-07.18	DBDD	Qty. 2	EPBMFT5-D040H	97032		

FLYING SPUR (4W_)

6.0	5998	460	12	03.13-	CVAA, DBDB		EPBMFT5-D040H	97032		
6.0 FLEX	5998	460	12	01.14-	CVAA		EPBMFT5-D040H	97032		

MULSANNE (3Y_)

6.8	6752	395	8	09.14-	CZMA		EPBMFT5-D040H	97032		
-----	------	-----	---	--------	------	--	---------------	-------	--	--

BMW

1 (E81,E82, E87, E88)

116 i	1596	85	4	06.04-06.11	N45B16A		EPBMFT5-D016H	95579	EPBMFT5-D003P	96835
-------	------	----	---	-------------	---------	--	---------------	-------	---------------	-------



MAFl kW
C
y
i

Type-N°

Stock-N°

Plug In
Alternative
Type-N°Plug In
Subtype**BMW****1 (E81,E82, E87, E88)**

116 i	1599	89	4	03.07-06.11	N43B16A, N43B16AA		EPBMFT5-D016H	95579		
116 i	1599	90	4	03.07-11.11	N43B16A, N43B16AA		EPBMFT5-D016H	95579		
116 d	1995	66	4	01.11-12.11	N47D20A, N47D20C		EPBMFN4-D004H	91534		
116 d	1995	85	4	03.09-06.11	N47D20A, N47D20C		EPBMFN4-D004H	91534		
118 d	1995	90	4	06.04-02.07	M47D20		EPBMFN4-D011H	94586		
116 i	1995	90	4	01.09-06.11	N43B20A		EPBMFT5-D034H	96295		
118 i	1995	95	4	07.04-02.07	N46B20B		EPBMFT5-D034H	96295	EPBMFT5-D003P	96835
118 i	1995	100	4	09.06-12.11	N46B20B		EPBMFT5-D034H	96295		
118 d	1995	100	4	03.07-06.11	N47D20A, N47D20C		EPBMFN4-D004H	91534		
118 d	1995	105	4	03.07-06.11	N47D20A, N47D20C		EPBMFN4-D004H	91534		
118 i	1995	105	4	03.08-12.13	N43B20A		EPBMFT5-D034H	96295		
120 i	1995	110	4	06.04-02.07	N46B20C, N46B20B, N46B20BD		EPBMFT5-D034H	96295	EPBMFT5-D003P	96835
120 i	1995	115	4	03.07-06.11	N46B20C, N46B20B, N46B20BD		EPBMFT5-D034H	96295		
120 d	1995	120	4	03.07-12.11	N47D20A, M47D20		EPBMFN4-D011H	94586		
120 d	1995	120	4	03.07-12.11	N47D20A, N47D20C		EPBMFN4-D004H	91534		
120 i	1995	120	4	03.07-06.11	N43B20A		EPBMFT5-D034H	96295		
118 i	1995	125	4	03.07-12.07	N43B20A		EPBMFT5-D034H	96295		
120 i	1995	125	4	03.07-06.11	N43B20A		EPBMFT5-D034H	96295		
120 d	1995	130	4	03.07-06.11	N47D20A, N47D20C		EPBMFN4-D004H	91534		
120 d	1995	145	4	03.07-12.11	N47D20A, N47D20C		EPBMFN4-D004H	91534		
123 d	1995	150	4	03.07-09.12	N47D20B, N47D20D		EPBMFN4-D004H	91534		

3 (E36)

318 i	1796	85	4	03.94-11.99	M43B18		EPBMFT5-D012H	93496	EPBMFT5-D003P	96835
316 i	1895	77	4	01.99-08.00	M43B19		EPBMFT5-D012H	93496	EPBMFT5-D003P	96835
325 td	2497	85	6	09.91-02.98	M51D25		EPBMFN6-R030H	90274		
325 tds	2497	105	6	03.95-04.99	M51D25		EPBMFN6-R030H	90274		

3 (E46)

316 i	1596	77	4	04.00-09.02	M43B16		EPBMFT5-D012H	93496	EPBMFT5-D003P	96835
316 i	1895	77	4	12.98-02.02	M43B19		EPBMFT5-D012H	93496	EPBMFT5-D003P	96835
316 Ci	1596	77	4	04.00-09.02	M43B16		EPBMFT5-D012H	93496	EPBMFT5-D003P	96835
316 ti	1596	77	4	06.02-02.05	N40B16A		EPBMFT5-D016H	95579		
316 Ci	1596	85	4	06.02-07.06	N45B16A		EPBMFT5-D016H	95579		
316 i	1596	85	4	06.02-02.05	N40B16A, N45B16A		EPBMFT5-D016H	95579		
316 ti	1596	85	4	06.02-02.05	N40B16A, N45B16A,		EPBMFT5-D016H	95579		
316 i	1796	85	4	02.02-02.05	N42B18		EPBMFT5-D016H	95579	EPBMFT5-D003P	96835
316 ti	1796	85	4	06.01-02.05	N42B18		EPBMFT5-D016H	95579	EPBMFT5-D003P	96835
318 Ci	1895	85	4	12.99-08.01	M43B19		EPBMFT5-D012H	93496		
318 i	1895	85	4	10.99-09.01	M43B19		EPBMFT5-D012H	93496		
318 d	1951	85	4	09.01-03.03	M47D20		EPBMFT5-D023H	93770		



MAF



l kW
C
Y
I



Type-N°

Stock-N°

Plug In
Alternative
Type-N°

Plug In
Stock-N°

BMW

3 (E46)

318 d	1995	85	4	03.03-02.05	M47D20		EPBMFT5-D023H	93770	EPBMFT5-D003P	96835
318 d	1995	85	4	03.03-02.05	M47D20		EPBMFN4-D011H	94586		
318 td	1995	85	4	03.03-02.05	M47D20		EPBMFT5-D023H	93770		
318 td	1995	85	4	03.03-02.05	M47D20		EPBMFN4-D011H	94586		
318 i	1895	87	4	10.99-09.01	M43B19		EPBMFT5-D012H	93496	EPBMFT5-D003P	96835
318 Ci	1895	87	4	12.99-08.01	M43B19		EPBMFT5-D012H	93496	EPBMFT5-D003P	96835
320 d	1951	95	4	02.98-08.01	M47D20		EPBMFT5-D023H	93770		
320 d	1951	100	4	03.00-09.01	M47D20		EPBMFT5-D023H	93770		
318 Ci	1995	100	4	12.00-05.06	N42B20A, N46B20A		EPBMFT5-D016H	95579		
318 i	1995	100	4	09.01-02.05	N42B20A		EPBMFT5-D016H	95579		
318 ti	1995	100	4	03.01-12.04	N42B20A, N46B20A		EPBMFT5-D016H	95579		
320 td	1995	100	4	10.01-12.02	M47D20	Euro4	EPBMFN4-D011H	94586		
318 Ci	1995	105	4	09.01-12.07	N42B20, N42B20A		EPBMFT5-D016H	95579		
318 i	1995	105	4	09.01-02.05	N42B20		EPBMFT5-D016H	95579	EPBMFT5-D003P	96835
318 ti	1995	105	4	03.01-12.04	N42B20		EPBMFT5-D016H	95579	EPBMFT5-D003P	96835
318 Ci	1995	110	4	02.05-12.07	N46B20B, N46B20A		EPBMFT5-D016H	95579		
320 i	1991	110	6	03.98-09.00	M52B20		EPBMWN3-A001H	97106		
320 Ci	1991	110	6	02.99-08.01	M52B20		EPBMWN3-A001H	97106		
320 d	1995	110	4	09.01-02.05	M47D20		EPBMFT5-D023H	93770	EPBMFT5-D003P	96835
320 d	1995	110	4	09.01-02.05	M47D20	Euro4	EPBMFN4-D011H	94586		
320 td	1995	110	4	09.01-02.05	M47D20		EPBMFT5-D023H	93770	EPBMFT5-D003P	96835
320 td	1995	110	4	09.01-02.05	M47D20	Euro4	EPBMFN4-D011H	94586		
320 Cd	1995	110	4	02.05-12.05	M47D20		EPBMFT5-D023H	93770	EPBMFT5-D003P	96835
320 Cd	1995	110	4	02.05-12.07	M47D20	Euro4	EPBMFN4-D011H	94586		
320 Ci	2171	120	6	01.00-05.06	M54B22		EPBMWN3-A001H	97106		
320 i	2171	120	6	09.00-02.05	M54B22		EPBMWN3-A001H	97106		
320 Ci	2171	125	6	01.00-05.06	M54B22		EPBMWN3-A001H	97106		
320 i	2171	125	6	09.00-02.05	M54B22		EPBMWN3-A001H	97106		
323 i	2494	120	6	03.98-09.00	M52B25		EPBMWN3-A001H	97106		
323 Ci	2494	120	6	04.99-09.00	M52B25		EPBMWN3-A001H	97106		
323 i	2494	125	6	09.98-09.00	M52B25		EPBMWN3-A001H	97106		
323 Ci	2494	125	6	04.99-09.00	M52B25		EPBMWN3-A001H	97106		
325 Ci	2494	141	6	09.00-05.06	M54B25		EPBMWN3-A001H	97106		
325 i	2494	141	6	09.00-02.05	M54B25		EPBMWN3-A001H	97106		
325 xi	2494	141	6	09.00-02.05	M54B25		EPBMWN3-A001H	97106		
325 ti	2494	141	6	04.01-12.04	M54B25		EPBMWN3-A001H	97106		
328 Ci	2793	142	6	12.98-05.00	M52B28		EPBMWN3-A001H	97106		
328 i	2793	142	6	06.99-05.00	M52B28		EPBMWN3-A001H	97106		
330 d	2926	135	6	10.99-03.03	M57D30		EPBMFT5-D023H	93770	EPBMFT5-D003P	96835
330 xd	2926	135	6	01.00-02.03	M57D30		EPBMFT5-D023H	93770		
330 d	2993	150	6	03.03-02.05	M57D30		EPBMFN4-D011H	94586		



MAF



l kW
C
y
i



Type-Nº

Stock-Nº

Plug In
Alternative
Type-Nº

Plug In
Stock-Nº

BMW

3 (E46)

330 xd	2993	150	6	08.02-05.05	M57D30		EPBMFN4-D011H	94586		
330 Cd	2993	150	6	03.03-07.06	M57D30		EPBMFN4-D011H	94586		
330 i	2979	168	6	01.01-04.05	M54B30		EPBMWN3-A001H	97106		
330 Ci	2979	170	6	06.00-08.06	M54B30		EPBMWN3-A001H	97106		
330 Ci	2979	170	6	06.00-01.05	M54B30		EPBMWN3-A015H	97380		
330 i	2979	170	6	06.00-01.05	M54B30		EPBMWN3-A015H	97380		
330 xi	2979	170	6	06.00-02.05	M54B30		EPBMWN3-A001H	97106		
330 xi	2979	170	6	06.00-01.05	M54B30		EPBMWN3-A015H	97380		

3 (E90, E91, E92, E93)

316 i	1596	85	4	09.05-10.11	N45B16AC, N45B16A		EPBMFT5-D016H	95579		
316 i	1599	90	4	09.07-06.13	N43B16A, N43B16AA		EPBMFT5-D016H	95579		
316 d	1995	85	4	07.09-12.11	N47D20C		EPBMFN4-D004H	91534		
316 d	1995	85	4	03.10-05.12	N47D20C		EPBMFT5-A051H	90866		
318 d	1995	90	4	03.05-08.07	M47D20		EPBMFN4-D011H	94586		
318 i	1995	95	4	01.06-08.07	N46B20B		EPBMFT5-D034H	96295		
318 d	1995	100	4	02.07-03.10	N47D20A, N47D20C		EPBMFN4-D004H	91534		
318 d	1995	100	4	02.07-03.10	N47D20A		EPBMFT5-A051H	90866		
318 i	1995	100	4	09.07-03.12	N46B20B		EPBMFT5-D034H	96295	EPBMFT5-D003P	96835
318 d	1995	105	4	02.07-10.11	N47D20A, N47D20C		EPBMFN4-D004H	91534		
318 d	1995	105	4	03.10-05.12	N47D20A, N47D20C		EPBMFT5-A051H	90866		
318 i	1995	105	4	03.10-12.13	N43B20A		EPBMFT5-D034H	96295		
320 d	1995	110	4	12.04-08.07	M47D20		EPBMFN4-D011H	94586		
320 i	1995	110	4	12.04-06.12	N46B20C, N46B20B, N46B20CB		EPBMFT5-D034H	96295	EPBMFT5-D003P	96835
320 i	1995	115	4	01.07-08.13	N46B20C, N46B20B		EPBMFT5-D034H	96295		
320 d	1995	120	4	12.04-10.11	M47D20, N47D20C	; Round Tube	EPBMFT5-A051H	90866		
320 d	1995	120	4	12.04-06.12	N47D20C, M47D20		EPBMFN4-D011H	94586		
320 d	1995	120	4	03.07-06.13	N47D20A, N47D20C		EPBMFN4-D004H	91534		
320 i	1995	120	4	01.07-12.13	N43B20A		EPBMFT5-D034H	96295		
320 d	1995	120	4	01.08-12.13	N47D20A, N47D20C		EPBMFT5-A051H	90866		
320 d xDrive	1995	120	4	07.09-06.12	N47D20C		EPBMFN4-D004H	91534		
320 d xDrive	1995	120	4	03.10-05.12	N47D20C		EPBMFT5-A051H	90866		
320 i	1995	125	4	02.07-12.12	N43B20A		EPBMFT5-D034H	96295		
320 d	1995	130	4	09.06-02.10	N47D20C	Number of Poles:4	EPBMFN4-D004H	91534		
320 d	1995	130	4	02.07-12.10	N47D20A, N47D20C		EPBMFN4-D004H	91534		
320 d xDrive	1995	130	4	09.08-02.10	N47D20C		EPBMFN4-D004H	91534		
320 d	1995	135	4	03.10-05.12	N47D20C		EPBMFT5-A051H	90866		
320 d	1995	135	4	03.10-05.12	N47D20C		EPBMFN4-D004H	91534		
320 d xDrive	1995	135	4	03.10-06.12	N47D20C		EPBMFT5-A051H	90866		
320 d xDrive	1995	135	4	03.10-06.12	N47D20C		EPBMFN4-D004H	91534		
320 d	1995	145	4	02.07-02.10	N47D20A, N47D20C		EPBMFN4-D004H	91534		
320 d xDrive	1995	145	4	02.08-02.10	N47D20C		EPBMFN4-D004H	91534		



MAF



l kW
C
Y
I



Type-N°

Stock-N°

Plug In
Alternative
Type-N°

Plug In
Stock-N°

BMW

3 (E90, E91, E92, E93)

320 d	1995	147	4	03.10-05.12	N47D20C		EPBMFT5-A051H	90866		
320 d	1995	147	4	03.10-05.12	N47D20C		EPBMFN4-D004H	91534		
320 d xDrive	1995	147	4	03.10-05.12	N47D20C		EPBMFT5-A051H	90866		
320 d xDrive	1995	147	4	03.10-05.12	N47D20C		EPBMFN4-D004H	91534		
320 si	1997	127	4	09.05-08.06	N45B20A		EPBMFT5-D034H	96295		
325 d	2993	145	6	02.07-02.10	M57D30		EPBMFN4-D011H	94586		
325 d	2993	155	6	02.07-02.10	M57D30		EPBMFN4-D011H	94586		
330 d	2993	170	6	03.06-08.08	M57D30		EPBMFN4-D011H	94586		
330 xd	2993	170	6	03.06-08.08	M57D30		EPBMFN4-D011H	94586		
330 d	2993	180	6	02.08-05.12	N57D30A		EPBMFN4-D011H	94586		
335 d	2993	210	6	03.06-03.13	M57D30		EPBMFN4-D009H	96113		

5 (E39)

520 d	1951	100	4	02.00-06.03	M47D20		EPBMFT5-D023H	93770		
520 i	1991	100	6	01.96-06.03	M52B20		EPBMWN3-A001H	97106		
520 i	1991	110	6	09.98-06.03	M52B20		EPBMWN3-A001H	97106		
520 i	2171	125	6	09.00-06.03	M54B22		EPBMWN3-A001H	97106		
523 i	2494	125	6	09.98-08.00	M52B25		EPBMWN3-A001H	97106		
525 td	2497	85	6	01.97-06.03	M51D25		EPBMFN6-R030H	90274		
525 tds	2497	105	6	01.96-06.03	M51D25		EPBMFN6-R030H	90274		
525 d	2497	120	6	02.00-05.04	M57D25		EPBMFT5-D023H	93770	EPBMFT5-D003P	96835
525 i	2494	141	6	09.00-05.04	M54B25		EPBMWN3-A001H	97106		
528 i	2793	142	6	09.98-08.00	M52B28		EPBMWN3-A001H	97106		
530 d	2926	135	6	08.98-09.00	M57D30		EPBMFT5-D023H	93770	EPBMFT5-D003P	96835
530 d	2926	142	6	09.98-06.03	M57D30		EPBMFT5-D023H	93770	EPBMFT5-D003P	96835
530 i	2979	170	6	09.00-06.03	M54B30		EPBMWN3-A015H	97380		
540 i	4398	210	8	09.98-12.03	M62B44		EPBMFT5-D060H	95878		

5 (E60, E61)

520 d	1995	110	4	09.05-02.07	M47D20		EPBMFN4-D011H	94586		
520 d	1995	120	4	04.05-05.10	M47D20		EPBMFN4-D011H	94586		
520 d	1995	120	4	04.05-05.10	N47D20C		EPBMFN4-D009H	96113		
520 d	1995	130	4	09.07-05.10	N47D20A, N47D20C		EPBMFN4-D009H	96113		
525 d	2497	120	6	03.04-03.07	M57D25		EPBMFN4-D011H	94586		
525 d	2497	130	6	03.04-03.07	M57D25		EPBMFN4-D011H	94586		
525 d	2993	145	6	01.07-03.10	M57D30		EPBMFN4-D011H	94586		
525 d xDrive	2993	145	6	09.07-12.09	M57D30		EPBMFN4-D011H	94586		
525 xd	2993	145	6	09.07-09.08	M57D30		EPBMFN4-D011H	94586		
530 d	2993	155	6	03.04-05.10	M57D30		EPBMFN4-D011H	94586		
530 d	2993	160	6	03.04-09.05	M57D30		EPBMFN4-D011H	94586		
530 d	2993	170	6	02.05-02.07	M57D30		EPBMFN4-D011H	94586		
530 xd	2993	170	6	02.05-02.07	M57D30		EPBMFN4-D011H	94586		
530 d	2993	173	6	02.07-05.10	M57D30		EPBMFN4-D011H	94586		
530 d xDrive	2993	173	6	09.07-05.10	M57D30		EPBMFN4-D011H	94586		
530 xd	2993	173	6	03.07-08.07	M57D30		EPBMFN4-D011H	94586		
535 d	2993	200	6	09.04-03.10	M57D30		EPBMFN4-D009H	96113		



MAF



l kW
C
Y
I



Type-N°

Stock-N°

Plug In
Alternative
Type-N°

Plug In
Subtype

BMW

5 (E60, E61)

535 d	2993	210	6	01.07-03.10	M57D30		EPBMFN4-D009H	96113		
545 i	4398	245	8	06.04-12.10	N62B44A		EPBMFT5-D056H	90827		

6 (E63)

635 d	2993	210	6	07.07-07.10	M57D30		EPBMFN4-D009H	96113		
645 Ci	4398	245	8	04.04-08.05	N62B44, N62B44A		EPBMFT5-D056H	90827		

7 (E38)

725 tds	2497	105	6	04.96-11.01	M51D25		EPBMFN6-R030H	90274		
728 i, iL	2793	142	6	09.98-11.01	M52B28		EPBMWN3-A001H	97106		
730 d	2926	135	6	08.98-04.00	M57D30		EPBMFT5-D023H	93770		
730 d	2926	142	6	04.00-11.01	M57D30		EPBMFT5-D023H	93770		
740 d	3901	180	8	05.99-11.01	M67D39		EPBMFT5-D012H	93496	EPBMFT5-D003P	96835
740 i, iL	4398	210	8	09.98-07.01	M62B44		EPBMFT5-D060H	95878		

7 (E65, E66, E67)

730 d	2993	150	6	09.02-08.03	M57D30		EPBMFN4-D011H	94586		
730 d	2993	155	6	09.03-08.08	M57D30		EPBMFN4-D011H	94586		
730 d	2993	160	6	06.02-02.05	M57D30		EPBMFN4-D011H	94586		
730 i, Li	2979	170	6	03.03-07.08	M54B30		EPBMWN6-D030H	96504		
730 Ld	2993	170	6	07.05-08.08	M57D30		EPBMFN4-D011H	94586		
735 i, Li	3600	200	8	09.03-02.05	N62B36A		EPBMFT5-D056H	90827		
740 d	3901	190	8	10.02-02.05	M67D39	Qty. 2	EPBMFN4-D004H	91534		
745 d	4423	220	8	03.05-08.05	M67D44	Qty. 2	EPBMFN4-D004H	91534		
745 d	4423	242	8	07.05-07.08	M67D44	Qty. 2	EPBMFN4-D004H	91534		
745 i, Li	4398	245	8	09.03-03.05	N62B44		EPBMFT5-D056H	90827		

X1 (E84)

sDrive 16 d	1995	85	4	04.12-06.15	N47D20C		EPBMFT5-A051H	90866		
sDrive 18 d	1995	100	4	03.09-06.15	N47D20C		EPBMFN4-D004H	91534		
xDrive 18 d	1995	100	4	03.09-06.15	N47D20C		EPBMFT5-A051H	90866		
xDrive 18 d	1995	100	4	03.09-06.15	N47D20C		EPBMFN4-D004H	91534		
sDrive 18 i	1995	100	4	03.10-06.15	N46B20B		EPBMFT5-D034H	96295		
sDrive 18 d	1995	105	4	12.09-06.12	N47D20C		EPBMFN4-D004H	91534		
xDrive 18 d	1995	105	4	10.09-06.12	N47D20C		EPBMFN4-D004H	91534		
xDrive 18 d	1995	105	4	03.10-06.15	N47D20C		EPBMFT5-A051H	90866		
sDrive 18 d	1995	105	4	07.12-06.15	N47D20C		EPBMFT5-A051H	90866		
sDrive 18 i	1995	110	4	03.10-06.15	N46B20B, N46B20BD		EPBMFT5-D034H	96295		
sDrive 20 d	1995	120	4	03.10-06.15	N47D20C		EPBMFN4-D004H	91534		
xDrive 20 d	1995	120	4	03.10-06.12	N47D20C		EPBMFT5-A051H	90866		
xDrive 20 d	1995	120	4	03.10-06.15	N47D20C		EPBMFN4-D004H	91534		
sDrive 20 d	1995	130	4	10.09-06.15	N47D20C		EPBMFN4-D004H	91534		
xDrive 20 d	1995	130	4	09.09-06.12	N47D20C		EPBMFN4-D004H	91534		
xDrive 20 d	1995	130	4	03.10-06.12	N47D20C		EPBMFT5-A051H	90866		
sDrive 20 d	1995	135	4	07.12-06.15	N47D20C		EPBMFT5-A051H	90866		



MAF



l kW
C
Y
I



Type-N°

Stock-N°

Plug In
Alternative
Type-N°

Plug In
stock-N°

BMW

X1 (E84)

xDrive 20 d	1995	135	4	07.12-06.15	N47D20C		EPBMFT5-A051H	90866		
xDrive 23 d	1995	150	4	10.09-06.15	N47D20D		EPBMFN4-D004H	91534		
xDrive 25 d	1995	160	4	07.12-06.15	N47D20D		EPBMFT5-A051H	90866		

X3 (E83)

xDrive 18 d	1995	100	4	04.09-12.11	N47D20C		EPBMFN4-D009H	96113		
xDrive 18 d	1995	105	4	09.08-12.11	N47D20C		EPBMFN4-D009H	96113		
2.0 d	1995	110	4	09.04-08.07	M47D20		EPBMFN4-D011H	94586		
2.0 i	1995	110	4	07.05-08.08	N46B20B		EPBMFT5-D034H	96295	EPBMFT5-D003P	96835
xDrive 20 i	1995	110	4	09.08-08.11	N46B20B		EPBMFT5-D034H	96295		
xDrive 20 d	1995	120	4	09.08-08.10	N47D20C		EPBMFN4-D009H	96113		
2.0 d	1995	130	4	09.07-08.08	N47D20A, N47D20C		EPBMFN4-D009H	96113		
xDrive 20 d	1995	130	4	09.08-08.10	N47D20C		EPBMFN4-D009H	96113		
2.5 i	2494	141	6	03.04-07.06	M54B25		EPBMWN6-V004H	96070		
3.0 d	2993	150	6	01.04-08.05	M57D30		EPBMFN4-D011H	94586		
3.0 d	2993	155	6	09.05-08.06	M57D30		EPBMFN4-D011H	94586		
3.0 d	2993	155	6	09.06-08.08	M57D30		EPBMFN4-D009H	96113		
xDrive 30 d	2993	155	6	09.08-08.10	M57D30		EPBMFN4-D009H	96113		
3.0 d	2993	160	6	09.05-08.06	M57D30		EPBMFN4-D011H	94586		
3.0 d	2993	160	6	09.06-08.08	M57D30		EPBMFN4-D009H	96113		
xDrive 30 d	2993	160	6	09.08-08.10	M57D30		EPBMFN4-D009H	96113		
3.0 i xDrive	2979	170	6	03.04-07.06	M54B30		EPBMWN6-D030H	96504		
3.0 sd	2993	210	6	09.06-08.08	M57D30		EPBMFN4-D009H	96113		

X5 (E53)

3.0 d	2925	135	6	04.01-09.03	M57D30		EPBMFT5-D023H	93770	EPBMFT5-D003P	96835
3.0 i	2979	170	6	10.00-10.06	M54B30		EPBMWN3-A015H	97380		
3.0 d	2993	155	6	10.03-09.06	M57D30		EPBMFN4-D011H	94586		
3.0 d	2993	160	6	10.03-09.06	M57D30		EPBMFN4-D011H	94586		
4.4 i	4398	210	8	01.00-09.03	M62B44		EPBMFT5-D060H	95878		
4.4 i	4398	235	8	10.03-10.06	N62B44, N62B44A		EPBMFT5-D056H	90827		
4.6 is	4619	255	8	10.01-08.03	M62B46		EPBMFT5-D060H	95878		
4.8 is	4799	265	8	04.04-09.06	N62B48A		EPBMFT5-D056H	90827		

X5 (E70)

3.0 d	2993	155	6	02.07-09.08	M57D30		EPBMFN4-D011H	94586		
3.0 d	2993	173	6	02.07-09.08	M57D30		EPBMFN4-D011H	94586		
xDrive 30 d	2993	173	6	10.08-03.10	M57D30		EPBMFN4-D011H	94586		
3.0 sd	2993	210	6	10.07-09.08	M57D30		EPBMFN4-D009H	96113		
xDrive 35 d	2993	210	6	10.08-07.13	M57D30		EPBMFN4-D009H	96113		

X6 (E71, E72)

xDrive 35 d	2993	210	6	01.08-03.10	M57D30		EPBMFN4-D009H	96113		
-------------	------	-----	---	-------------	--------	--	---------------	-------	--	--

Z3 ROADSTER / COUPE (E36)

1.9 i	1895	85	4	01.99-01.03	M43B19		EPBMFT5-D012H	93496		
1.9 i	1895	87	4	07.98-01.03	M43B19TU, M43B19		EPBMFT5-D012H	93496	EPBMFT5-D003P	96835
2.0 i	1991	110	6	04.99-01.03	M52B20		EPBMWN3-A001H	97106		



MAF



l kW
C
Y
I



Type-N°

Stock-N°

Plug In
Alternative
Type-N°

Plug In
Subtype

BMW

Z3 ROADSTER / COUPE (E36)

2.2 i	2171	125	6	10.00-06.02	M54B22		EPBMWN3-A001H	97106		
2.8 i	2793	142	6	07.97-06.00	M52B28		EPBMWN3-A001H	97106		
3.0 i	2979	170	6	06.00-06.03	M54B30		EPBMWN3-A015H	97380		

Z4 ROADSTER (E85)

2.0 i	1995	110	4	03.05-02.09	N46B20A, N46B20B		EPBMFT5-D034H	96295	EPBMFT5-D003P	96835
2.2 i	2171	125	6	10.03-10.05	M54B22		EPBMWN6-V004H	96070		
2.5 i	2494	141	6	03.03-12.05	M54B25		EPBMWN6-V004H	96070		
3.0 i	2979	170	6	03.03-12.05	M54B30		EPBMWN6-D030H	96504		

Z8 ROADSTER (E52)

4.9	4941	294	8	06.00-06.03	S38B49	Qty. 2	EPBMFN5-D016H	96999	EPBMFN5-D002P	91609
-----	------	-----	---	-------------	--------	--------	---------------	-------	---------------	-------

BOGDAN

2110

1.6	1597	60	4	01.10-12.14	VAZ21114		EPBMFT5-V039H	90466		
1.6	1597	65	4	01.10-12.14	VAZ21124		EPBMFT5-V039H	90466		
1.6	1597	66	4	01.10-12.14	VAZ21124		EPBMFT5-V039H	90466		

2111

1.6	1597	60	4	01.10-12.14	VAZ21114		EPBMFT5-V039H	90466		
1.6	1597	65	4	01.10-12.14	VAZ21124		EPBMFT5-V039H	90466		
1.6	1597	66	4	01.10-12.14	VAZ21124		EPBMFT5-V039H	90466		

2310

1.6	1597	60	4	01.10-12.14	VAZ21114		EPBMFT5-V039H	90466		
1.6	1597	66	4	01.10-12.14	VAZ21124		EPBMFT5-V039H	90466		

CADILLAC

BLS / BLS WAGON

1.9 D	1910	110	4	04.06-	Z19DTH		EPBMFN4-V026H	94497		
1.9 D	1910	110	4	04.06-	Z19DTH		EPBMFN4-V010H	97588		
1.9 D	1910	132	4	12.07-	Z19DTR		EPBMFN4-V020H	90971		

CTS

2.8	2792	158	6	03.05-08.05	LP1		EPBMFT5-V001P	93006		
3.2	3175	160	6	03.02-08.04	LA3		EPBMFT5-V001P	93006		

CHEVROLET

AVEO (T300)

1.2	1229	51	4	03.11-	LWD	; Not for manufacturer emission norm:5EA	EPBMFT5-T001D	94095		
1.2	1229	63	4	03.11-	LDC	; Not for manufacturer emission norm:5EA	EPBMFT5-T001D	94095		
1.2 LPG	1229	63	4	11.12-12.15	LDC	; Not for manufacturer emission norm:5EA	EPBMFT5-T001D	94095		
1.4	1398	74	4	03.11-	LDD	; Not for manufacturer emission norm:5EA	EPBMFT5-T001D	94095		
1.6	1598	85	4	03.11-	LDE	; Not for manufacturer emission norm:5EA	EPBMFT5-T001D	94095		



MAF



l kW
C
Y
I



Type-N°

Stock-N°

Plug In
Alternative
Type-N°

Plug In
Stock-N°

CHEVROLET

CAPTIVA (C100, C140)

2.0 D	1991	93	4	10.06-	LLW		EPBMFN4-V010H	97588		
2.0 D 4WD	1991	93	4	10.06-	LLW		EPBMFN4-V010H	97588		
2.0 D 4WD	1991	110	4	10.06-02.11	LLW		EPBMFN4-V010H	97588		
2.0 D	1991	110	4	09.07-02.11	LLW		EPBMFN4-V010H	97588		

COLORADO | LUV D-MAX

3.5	3460	164	5	05.05-09.06	L52		EPBMWT5-V023H	95103		
3.5 4x4	3460	164	5	05.05-09.06	L52		EPBMWT5-V023H	95103		

CRUZE (J300, J305, J308)

1.4	1398	74	4	07.13-	LDD		EPBMFT5-T001D	94095		
1.4	1364	103	4	09.10-	LUJ		EPBMFT5-T001D	94095		
1.7 TD	1686	81	4	08.13-	LKR		EPBMFT5-T011H	92630		
1.7 D	1686	96	4	01.12-	LUJ		EPBMFT5-T011H	92630		
2.0 CDI	1991	92	4	05.09-05.11	LLW		EPBMFT5-T003H	91493		
2.0 CDI	1991	110	4	05.09-	LLW		EPBMFT5-T003H	91493		
2.0 CDI	1998	120	4	08.10-	LNP		EPBMFT5-T003H	91493		

EPICA (KL1_) | TOSCA

2.0 D	1991	110	4	01.07-	LLW		EPBMFN4-V017H	96226		
-------	------	-----	---	--------	-----	--	---------------	-------	--	--

LACETTI (J200)

2.0 D	1991	89	4	01.07-	LMN		EPBMFN4-V026H	94497		
2.0 D	1991	89	4	01.07-	LMN		EPBMFN4-V010H	97588		

MALIBU (V300)

2.0 D	1956	118	4	04.12-	LBS		EPBMFT5-T003H	91493		
-------	------	-----	---	--------	-----	--	---------------	-------	--	--

NIVA (2123)

1.7 4x4	1690	59	4	09.02-	2123	Euro2	EPBMFT5-V039H	90466	EPBMFT5-V001P	93006
---------	------	----	---	--------	------	-------	---------------	-------	---------------	-------

NUBIRA ESTATE/SALOON

2.0 D	1991	89	4	01.07-12.11	LMN		EPBMFN4-V026H	94497		
2.0 D	1991	89	4	01.07-12.07	LMN		EPBMFN4-V010H	97588		

ORLANDO (J309)

1.4	1362	103	4	06.12-	LUJ		EPBMFT5-T001D	94095		
2.0 D	1998	96	4	02.11-	LNP		EPBMFT5-T003H	91493		
2.0 D	1998	120	4	02.11-	LNP		EPBMFT5-T003H	91493		

TRAX | TRACKER

1.4	1364	103	4	12.12-	LUJ		EPBMFT5-T001D	94095		
1.4 AWD	1364	103	4	12.12-	LUJ		EPBMFT5-T001D	94095		
1.6	1598	85	4	12.12-	LDE		EPBMFT5-T001D	94095		

VOLT

EV 150	1398	111	4	11.11-	LUU		EPBMFT5-T001D	94095		
--------	------	-----	---	--------	-----	--	---------------	-------	--	--

CHRYSLER

300C (LX, LE)

3.0 V6 CRD	2987	155	6	11.10-11.12	EXL		EPBMFN4-D014H	92888		
3.0 CRD	2987	160	6	09.05-11.12	EXL		EPBMFN4-D014H	92888		



MAF



l kW
C
y
I



Type-Nº

Stock-Nº

Plug In
Alternative
Type-Nº

Plug In
Subtype

CHRYSLER

DELTA

2.0 D Multijet	1956	121	4	08.11-	198A5000		EPBMFT4-V004H	90957		
----------------	------	-----	---	--------	----------	--	---------------	-------	--	--

PT CRUISER (PT_)

2.2 CRD	2148	89	4	10.02-08.08	EDJ		EPBMFT5-V053H	95935		
2.2 CRD	2148	110	4	08.05-12.10	EDJ		EPBMFT5-V053H	95935		
GT 2.4	2429	164	4	08.03-12.10	EDV		EPBMFT5-V053H	95935		
2.4 GT	2429	164	4	03.04-03.08	EDV		EPBMFT5-V053H	95935		
2.4	2429	169	4	09.04-12.10	EDV		EPBMFT5-V053H	95935		

SEBRING (JS)

2.0 CRD	1968	103	4	07.07-12.10	ECD		EPBMFN5-D047H	91140		
---------	------	-----	---	-------------	-----	--	---------------	-------	--	--

VOYAGER IV (RG, RS)

2.5 CRD	2499	105	4	-01.04	ENJ		EPBMFT5-V017H	90311		
2.8 CRD	2776	110	4	06.04-12.08	ENR		EPBMFT5-V017H	90311		

YPSILON

1.3 Multijet	1248	70	4	05.11-	199B1000		EPBMFT4-V004H	90957		
2.2 CRD	2148	89	4	03.02-12.10	EDJ		EPBMFT5-V053H	95935		

CITROËN

BERLINGO (B9)

1.6 HDi 75	1560	55	4	04.08-	9HT		EPBMFT5-A001H	93740		
1.6 HDi 75 / BlueHDi 75	1560	55	4	04.08-	9HN		EPBMWT4-A026H	95537		
1.6 HDi 75 16V	1560	55	4	04.08-	9HT		EPBMFT5-A001H	93740		
1.6 HDi / BlueHDi 75	1560	55	4	07.10-	9HN		EPBMWT4-A026H	95537		
1.6 HDi 90	1560	66	4	04.08-	9HX		EPBMFT5-A001H	93740		
1.6 HDi 90 16V	1560	66	4	04.08-	9HS, 9HX		EPBMFT5-A001H	93740		
1.6 HDi 90	1560	66	4	07.10-	9HE, 9HF		EPBMWT4-A026H	95537		
1.6 HDi 92	1560	68	4	07.10-	9HJ, 9HP		EPBMWT4-A026H	95537		
1.6 HDi 110	1560	80	4	04.08-	9HZ		EPBMFT5-A001H	93740		
1.6 HDi 110	1560	82	4	07.10-	9HL, 9HR		EPBMWT4-A026H	95537		
1.6 HDi 115	1560	84	4	07.10-	9HR, 9HL		EPBMWT4-A026H	95537		
1.6	1587	66	4	04.08-	NFR		EPBMFT5-A001H	93740		

BERLINGO / BERLINGO FIRST BOX BODY/MPV (M_)

1.6 HDi 75	1560	55	4	07.05-12.11	DV6B		EPBMFT5-A001H	93740		
1.6 HDi 90	1560	66	4	07.05-12.11	9HX		EPBMFT5-A001H	93740		
1.9 D 70 4WD	1868	51	4	07.98-11.02	WJY		EPBMWT5-A004H	91200		
1.9 D 70	1868	51	4	04.99-11.02	WJY		EPBMWT5-A004H	91200		
1.9 D 70	1868	51	4	11.02-12.11	WJY		EPBMWT5-A003H	93842		
1.9 D 70 4WD	1868	51	4	11.02-03.06	WJY		EPBMWT5-A003H	93842		
2.0 HDi 90	1997	66	4	12.99-12.11	RHY		EPBMWT5-A003H	93842		
2.0 HDi 90 4WD	1997	66	4	11.00-10.05	RHY		EPBMWT5-A003H	93842		



MAF



l kW
C
Y
I



Type-N°

Stock-N°

Plug In
Alternative
Type-N°

Plug In
Subtype

CITROËN

BERLINGO / BERLINGO FIRST MPV (MF_, GJK_, GFK_)

1.6 HDi 75	1560	55	4	07.05-12.11	DV6B		EPBMFT5-A001H	93740		
1.6 HDi 90	1560	66	4	07.05-05.08	9HX		EPBMFT5-A001H	93740		
1.9 D	1868	51	4	07.98-11.02	WJY		EPBMWT5-A004H	91200		
1.9 D 4WD	1868	51	4	07.98-11.02	WJY		EPBMWT5-A004H	91200		
1.9 D	1868	51	4	11.02-10.05	WJY		EPBMWT5-A003H	93842		
1.9 D 4WD	1868	51	4	11.02-10.05	WJY		EPBMWT5-A003H	93842		
2.0 HDi 90	1997	66	4	12.99-10.05	RHY		EPBMWT5-A003H	93842		
2.0 HDi 4x4	1997	66	4	11.02-10.05	RHY		EPBMWT5-A003H	93842		

C1 (PM_, PN_)

1.4 HDi	1398	40	4	06.05-09.14	8HT		EPBMWT4-A009H	92423		
---------	------	----	---	-------------	-----	--	---------------	-------	--	--

C15 BOX BODY/MPV (VD_)

1.9 D	1868	44	4	12.00-12.05	DW8B		EPBMWT5-A004H	91200		
-------	------	----	---	-------------	------	--	---------------	-------	--	--

C2 (JM_, JG_)

1.4 HDi	1398	50	4	09.03-12.09	8HX, 8HZ		EPBMWT6-A006H	94034		
1.4 HDi	1398	50	4	04.09-	8HX, 8HZ	; Euro4	EPBMWT4-A009H	92423		
1.4 HDi	1398	51	4	09.03-	8HX, 8HZ	; Euro4	EPBMWT4-A009H	92423		
1.6 HDi	1560	80	4	07.07-	9HZ		EPBMFT5-A001H	93740		

C3 AIRCROSS II (2R_, 2C_)

1.6 HDi 92	1560	68	4	10.17-	9HP		EPBMWT4-A026H	95537		
------------	------	----	---	--------	-----	--	---------------	-------	--	--

C3 I (FC_, FN_)

1.4 HDi	1398	50	4	02.02-	8HX, 8HZ	; Not for Euro5	EPBMWT6-A006H	94034		
1.4 HDi	1398	55	4	05.05-	8HX	; Not for Euro5	EPBMWT6-A006H	94034		
1.6 16V HDi	1560	66	4	10.05-03.07	9HX		EPBMFT5-A001H	93740		
1.6 16V HDi	1560	80	4	09.05-	9HZ		EPBMFT5-A001H	93740		

C3 II (SC_)

1.4 HDi 70	1398	50	4	11.09-	8HZ, 8HR		EPBMWT4-A009H	92423		
1.4 HDi 70	1398	50	4	11.09-	8HZ		EPBMWT6-A006H	94034		
1.4 HDi	1398	50	4	06.10-09.16	8HR		EPBMWT4-A026H	95537		
1.6 BlueHDi 75	1560	55	4	04.15-	9HK		EPBMWT4-A026H	95537		
1.6 HDi 90	1560	66	4	11.09-	9HX		EPBMFT5-A001H	93740		
1.6 HDi	1560	68	4	11.09-09.16	9HJ, 9HP		EPBMFT5-A001H	93740		
1.6 HDi	1560	68	4	11.09-09.16	9HJ, 9HP		EPBMWT4-A026H	95537		
1.6 HDi 110	1560	82	4	11.09-	9HR		EPBMFT5-A001H	93740		
1.6 HDi 110	1560	82	4	11.09-	9HR		EPBMWT4-A026H	95537		
1.6 HDi 115	1560	84	4	09.12-	9HD		EPBMWT4-A026H	95537		

C3 PICASSO (SH_)

1.6 HDi	1560	66	4	02.09-	9HX		EPBMFT5-A001H	93740		
1.6 HDi 90	1560	68	4	07.10-	9HP		EPBMWT4-A026H	95537		
1.6 HDi	1560	80	4	02.09-	9HZ		EPBMFT5-A001H	93740		



MAF



l kW
C
y
I



Type-N°

Stock-N°

Plug In
Alternative
Type-N°

Plug In
Subtype

CITROËN

C3 PICASSO (SH_)

1.6 HDi 110	1560	82	4	05.10-	9HR		EPBMWT4-A026H	95537		
1.6 HDi 115	1560	84	4	01.13-	9HD		EPBMWT4-A026H	95537		

C3 PLURIEL (HB_)

1.4 HDi	1398	50	4	04.04-	8HX	; Euro4	EPBMWT4-A009H	92423		
1.4 HDi	1398	50	4	04.04-	8HX	; Not for Euro5	EPBMWT6-A006H	94034		

C4 AIRCROSS

1.6 HDi 115	1560	84	4	04.12-	9HD		EPBMWT4-A026H	95537		
1.6 HDi 115 AWC	1560	84	4	05.12-	9HL		EPBMWT4-A026H	95537		

C4 CACTUS

1.6 HDi 90	1560	68	4	09.14-	9HJ, 9HP		EPBMWT4-A026H	95537		
------------	------	----	---	--------	----------	--	---------------	-------	--	--

C4 I (UA_, LC_, DU_, LA_)

1.6 HDi	1560	66	4	11.04-07.11	9HX		EPBMFT5-A001H	93740		
1.6 HDi	1560	80	4	07.06-07.11	9HY, 9HZ		EPBMFT5-A001H	93740		
1.6 HDi 110	1560	82	4	09.10-08.13	9HR		EPBMWT4-A026H	95537		
2.0 HDi	1997	100	4	11.04-07.11	RHR		EPBMWT4-A011H	90069		
2.0 HDi 138	1997	100	4	10.06-12.13	RHJ, RHR		EPBMWT4-A011H	90069		
2.0 HDi	1997	103	4	07.08-07.11	RHF		EPBMWT4-A011H	90069		
2.0 HDi 150	1997	110	4	07.09-08.13	RHE	;	EPBMWT4-A028H	91236		
2.0 HDi 165	1997	120	4	09.10-08.13	RHH	;	EPBMWT4-A028H	91236		

C4 I BOX BODY (LR_)

2.0 HDi	1997	100	4	02.05-12.10	RHR		EPBMWT4-A011H	90069		
---------	------	-----	---	-------------	-----	--	---------------	-------	--	--

C4 II (B7, NC_, DA_, DE_)

1.6 HDi	1560	68	4	06.10-	9HP		EPBMWT4-A026H	95537		
1.6 HDi 90	1560	68	4	02.13-	9HP		EPBMWT4-A026H	95537		
1.6 HDi	1560	82	4	11.09-	9HR		EPBMWT4-A026H	95537		
1.6 HDi 110	1560	82	4	11.09-	9HR		EPBMWT4-A026H	95537		
1.6 HDi 115	1560	84	4	07.12-	9HD		EPBMWT4-A026H	95537		
1.6 HDi / BlueHDi 115	1560	85	4	02.13-	9HC		EPBMWT4-A026H	95537		
2.0 HDi / BlueHDi 150	1997	110	4	11.09-	AHR, RHE	; ; RPO>12747; RPO<12571	EPBMWT4-A028H	91236		
2.0 HDi / BlueHDi 150	1997	110	4	11.09-	RHE		EPBMWT4-A011H	90069		
2.0 BlueHDi 150	1997	110	4	06.13-	AHE, AHR, AHX		EPBMWN4-A024H	90997		
2.0 HDi / BlueHDi 160	1997	120	4	04.11-09.11	RHH		EPBMWT4-A011H	90069		

C4 PICASSO I MPV (UD_)

1.6 HDi	1560	80	4	02.07-08.13	9HY, 9HZ		EPBMFT5-A001H	93740		
2.0 HDi 138	1997	100	4	10.06-08.13	RHJ, RHR		EPBMWT4-A011H	90069		

C5 I (DC_, DE_)

2.0 HDi	1997	66	4	03.01-08.04	RHY		EPBMWT5-A005H	93383		
2.0 HDi	1997	79	4	03.01-08.04	RHS, RHZ		EPBMWT5-A005H	93383		
2.0 HDi	1997	80	4	03.01-08.04	RHZ		EPBMWT5-A005H	93383		



MAF



l kW
C
Y
I



Type-N°

Stock-N°

Plug In
Alternative
Type-N°

Plug In
stock-N°

CITROËN

C5 I (DC_, DE_)

2.2 HDi	2179	98	4	03.01-08.04	4HX		EPBMWT5-A005H	93383		
---------	------	----	---	-------------	-----	--	---------------	-------	--	--

C5 II (RC_, RE_)

1.6 HDi	1560	80	4	09.04-	9HY, 9HZ		EPBMFT5-A001H	93740		
2.0 HDi	1997	100	4	09.04-	RHR		EPBMWT4-A008H	90627		
2.2 HDi	2179	98	4	09.04-	4HX		EPBMWT5-A005H	93383		

C5 III (RD_, RW_)

1.6 HDi 110	1560	80	4	02.08-	9HZ		EPBMFT5-A001H	93740		
1.6 HDi 110	1560	82	4	07.10-	9HL, 9HR		EPBMWT4-A026H	95537		
1.6 HDi 115	1560	84	4	01.12-	9HL, 9HR		EPBMWT4-A026H	95537		
2.0 HDi	1997	100	4	02.08-	RHF, RHR		EPBMWT4-A008H	90627		
2.0 HDi 140	1997	103	4	04.09-	RHF		EPBMWT4-A008H	90627		
2.0 HDi 150 / BlueHDi 150	1997	110	4	04.09-	AHR, RHE	; ; RPO<12573	EPBMWN4-A024H	90997		
2.0 HDi 165	1997	120	4	04.09-	RHH	; ; RPO<12573	EPBMWN4-A024H	90997		
2.0 HDi 180	1997	133	4	03.15-	AHW		EPBMWN4-A024H	90997		
2.2 HDi 200	2179	150	4	07.10-	4HL	;	EPBMWN4-A024H	90997		
2.7 HDi	2720	150	6	02.08-	UHZ		EPBMWT4-A011H	90069		
3.0 HDi 240	2992	177	6	04.09-10.14	DT20C		EPBMWT4-A028H	91236		

C6 (TD_)

2.7 HDi	2720	150	6	09.05-12.11	UHZ		EPBMWT4-A011H	90069		
3.0 HDi	2993	177	6	04.09-12.12	DT20C		EPBMWT4-A028H	91236		

C8 (EA_, EB_)

2.0 HDi	1997	79	4	07.02-	RHS, RHT		EPBMWT5-A005H	93383		
2.0 HDi	1997	80	4	07.02-	RHW		EPBMWT5-A005H	93383		
2.0 HDi	1997	81	4	07.02-	RHT		EPBMWT5-A005H	93383		
2.0 HDi	1997	88	4	07.06-	RHK		EPBMWT4-A008H	90627		
2.0 HDi 135	1997	100	4	03.06-	RHD, RHR	;	EPBMWN4-A024H	90997		
2.0 HDi 165	1997	120	4	03.06-	RHE		EPBMWT4-A028H	91236		
2.0 HDi 165	1997	120	4	03.06-	RHH	;	EPBMWN4-A024H	90997		
2.2 HDi	2179	94	4	07.02-	4HW		EPBMWT5-A005H	93383		
2.2 HDi	2179	125	4	06.06-	4HT		EPBMWT4-A008H	90627		

C-CROSSER (VU_, VV_)

2.2 HDi	2179	115	4	01.09-	4HK, 4HN		EPBMWT4-A008H	90627		
---------	------	-----	---	--------	----------	--	---------------	-------	--	--

C-ELYSEE

1.6 HDi 92	1560	68	4	11.12-	9HJ, 9HP		EPBMWT4-A026H	95537		
------------	------	----	---	--------	----------	--	---------------	-------	--	--

DS3

1.4 HDi 70	1398	50	4	04.10-07.15	8HR		EPBMWT4-A026H	95537		
1.6 HDi 90	1560	68	4	01.13-07.15	9HP		EPBMWT4-A026H	95537		
1.6 HDi 110	1560	82	4	11.09-07.15	9HR		EPBMWT4-A026H	95537		
1.6 HDi 115	1560	84	4	08.12-07.15	9HD		EPBMWT4-A026H	95537		



MAF



l kW
C
y
I



Type-N°

Stock-N°

Plug In
Alternative
Type-N°

Plug In
Subtype

CITROËN

DS4

1.6 HDi 90	1560	68	4	05.11-07.15	9HP		EPBMWT4-A026H	95537		
1.6 HDi 110	1560	82	4	04.11-07.15	9HR		EPBMWT4-A026H	95537		
1.6 HDi 115	1560	84	4	08.12-07.15	9HD		EPBMWT4-A026H	95537		
2.0 HDi / BlueHDi 135	1997	100	4	09.11-07.15	AHS, AHV, RHD		EPBMWN4-A024H	90997		
2.0 HDi / BlueHDi 135	1997	100	4	09.11-07.15	AHS, AHV, RHD	; RPO>12747; RPO<12571	EPBMWT4-A028H	91236		
2.0 HDi / BlueHDi 135	1997	100	4	09.11-07.15	RHD		EPBMWT4-A011H	90069		
2.0 HDi 165	1997	120	4	04.11-07.15	RHH	; RPO>12747; RPO<12571	EPBMWT4-A028H	91236		
2.0 HDi 165	1997	120	4	-09.11	RHH		EPBMWT4-A011H	90069		
2.0 BlueHDi 180	1997	133	4	07.14-07.15	AHW		EPBMWN4-A024H	90997		

DS5

1.6 HDi 110	1560	82	4	11.11-07.15	9HR		EPBMWT4-A026H	95537		
1.6 HDi 115	1560	84	4	06.12-07.15	9HD		EPBMWT4-A026H	95537		
2.0 HDi 135	1997	100	4	11.11-07.15	RHD		EPBMWT4-A028H	91236		
2.0 BlueHDi 150	1997	110	4	07.14-07.15	AHX		EPBMWN4-A024H	90997		
2.0 HDi 165	1997	120	4	11.11-07.15	RHH		EPBMWT4-A028H	91236		
2.0 HDi 165 Hybrid4 4x4	1997	120	4	12.11-07.15	RHC		EPBMWT4-A028H	91236		
2.0 BlueHDi 180	1997	133	4	08.13-07.15	AHW		EPBMWN4-A024H	90997		

EVASION MPV (22, U6) | SYNERGIE

2.0 HDi	1997	80	4	08.99-07.02	RHZ		EPBMWT5-A003H	93842		
2.0 HDi 16V	1997	80	4	09.99-07.02	RHW		EPBMWT5-A003H	93842		

GRAND C4 SPACETOURER (3A_, 3E_)

1.6 HDi 115	1560	85	4	04.18-	9HC		EPBMWT4-A026H	95537		
-------------	------	----	---	--------	-----	--	---------------	-------	--	--

JUMPER (230L, 230P, 244, Z_)

2.0 HDi	1997	62	4	04.02-	RHV		EPBMWT5-A004H	91200		
2.2 HDi	2179	74	4	02.02-06.06	4HY		EPBMWT5-A004H	91200		
2.8 HDi 4x4	2798	94	4	02.02-06.06	F28TDCR, 814043S		EPBMFT5-V008H	93715		

JUMPER | RELAY

2.2 HDi 100	2198	74	4	04.06-	4HV		EPBMWT4-A001D	95860		
2.2 HDi 110	2198	81	4	07.11-	4HG		EPBMWT4-V003D	94395		
2.2 HDi 120	2198	88	4	04.06-	4HU		EPBMWT4-A001D	95860		
2.2 HDi 130	2198	96	4	07.11-	PUMA22DT		EPBMWT4-A001D	95860		
2.2 HDi 130	2198	96	4	07.11-	PUMAC96EURO5		EPBMWT4-V003D	94395		
2.2 HDi 150	2198	110	4	07.11-	4HJ		EPBMWT4-V003D	94395		
3.0 HDi 145	2999	107	4	07.10-	F30DTE		EPBMFN4-V020H	90971		
3.0 HDi 155	2999	115	4	07.10-	F1CE0481D		EPBMFN4-V020H	90971		
3.0 HDi 160	2999	116	4	09.06-	F1CE0481D		EPBMFN4-V020H	90971		
3.0 HDi 180	2999	130	4	07.11-	F1CE3481E		EPBMFT4-V061H	94528		



MAF



l kW
C
Y
I



Type-N°

Stock-N°

Plug In
Alternative
Type-N°

Plug In
stock-N°

CITROËN

JUMPY (U6U_, BS_, BT_, BY_, BZ_, BU_, BV_, BW_, BX_)

1.9 D 70	1868	51	4	04.98-10.06	WJY, WJZ		EPBMWT5-A003H	93842		
2.0 HDi 95	1997	69	4	10.99-10.06	RHX		EPBMWT5-A003H	93842		
2.0 HDi 110	1997	80	4	03.00-10.06	RHZ		EPBMWT5-A003H	93842		

JUMPY (V_)

2.0 BlueHDi 120	1997	90	4	04.16-	AHJ, AHK		EPBMWT4-A028H	91236		
2.0 BlueHDi 150	1997	110	4	04.16-	AHR, AHX		EPBMWT4-A028H	91236		

JUMPY (VF7)

1.6 HDi 90 16V	1560	66	4	01.07-	DV6JTED4		EPBMFT5-A001H	93740		
1.6 HDi 90 8V	1560	66	4	01.07-	9HH, 9HM		EPBMWT4-A026H	95537		
2.0 HDi 95	1997	72	4	07.11-	AHY		EPBMWN4-A024H	90997		
2.0 HDi 120	1997	88	4	01.07-	RHK		EPBMWT4-A008H	90627		
2.0 HDi 125	1997	94	4	07.11-	AHZ		EPBMWN4-A024H	90997		
2.0 HDi 125 4x4	1997	94	4	07.11-	AHZ		EPBMWN4-A024H	90997		
2.0 HDi 140	1997	100	4	01.07-	RHR		EPBMWT4-A008H	90627		
2.0 HDi 165	1997	120	4	07.10-	RHH		EPBMWN4-A024H	90997		

NEMO (AA_)

1.3 HDi 75	1248	55	4	10.10-	FHZ		EPBMFT4-V004H	90957		
1.3 HDi 80	1248	59	4	10.15-	FHY		EPBMFT4-V004H	90957		
1.3 BlueHDi 80	1248	59	4	02.16-	FHY		EPBMFT4-V004H	90957		
1.4 HDi	1398	50	4	02.08-	8HS		EPBMWT4-A009H	92423		
1.4 HDi	1399	50	4	04.09-	8HS		EPBMWT4-A009H	92423		

SPACETOURER (V_) | DISPATCH

2.0 BlueHDi 120	1997	90	4	04.16-	AHJ, AHK		EPBMWT4-A028H	91236		
2.0 BlueHDi 150	1997	110	4	04.16-	AHR, AHX		EPBMWT4-A028H	91236		
2.0 BlueHDi 180	1997	130	4	04.16-	AHH		EPBMWT4-A028H	91236		

XANTIA (X1_, X2_)

2.0 HDi 90	1997	66	4	03.99-04.03	RHY		EPBMWT5-A003H	93842		
2.0 HDi 109	1997	80	4	02.99-04.03	RHZ		EPBMWT5-A003H	93842		

XSARA (N0, N1, N2, N68, ESTATE VAN)

1.4 HDi	1398	50	4	01.03-03.05	8HX		EPBMWT6-A006H	94034		
1.6 HDi	1560	66	4	09.05-12.11	9HX		EPBMFT5-A001H	93740		
1.6 HDi	1560	80	4	05.04-12.11	9HY, 9HZ		EPBMFT5-A001H	93740		
1.9 D	1868	51	4	02.99-03.05	DW8B, WJY		EPBMWT5-A003H	93842		
2.0 HDi	1997	66	4	12.99-12.11	RHY		EPBMWT5-A004H	91200		
2.0 HDi 90	1997	66	4	02.99-03.05	RHY		EPBMWT5-A003H	93842		
2.0 HDi	1997	66	4	09.00-03.05	RHY		EPBMWT5-A003H	93842		
2.0 HDi 109	1997	80	4	05.01-03.05	RHZ		EPBMWT5-A004H	91200		
2.0 HDi 109	1997	80	4	05.01-03.05	RHZ		EPBMWT5-A003H	93842		



MAF



l kW
C
Y
I



Type-N°

Stock-N°

Plug In
Alternative
Type-N°

Plug In
Subtype

DACIA

DUSTER (HS_)

1.5 dCi	1461	63	4	04.10-01.18	K9K796, K9K830			EPBMWT6-V013H	92412		
1.5 dCi	1461	63	4	04.10-01.18	K9K796, K9K830	6-Speed; OE 8200682558		EPBMWT4-A022H	93854		
1.5 dCi	1461	66	4	10.10-01.18	K9K612, K9K884, K9K892	6-Speed		EPBMWT4-A022H	93854		
1.5 dCi	1461	66	4	10.10-01.18	K9K892, K9K884	; Type:HSA6, HSM0, HSMG, HSMV		EPBMWT4-A019H	94808		
1.5 dCi 4x4	1461	66	4	10.10-01.18	K9K884, K9K894	; OE 8200682558		EPBMWT4-A022H	93854		
1.5 dCi 4x4	1461	66	4	10.10-01.18	K9K894, K9K884			EPBMWT4-A019H	94808		
1.5 dCi	1461	79	4	06.10-01.18	K9K896			EPBMWT4-A019H	94808		
1.5 dCi	1461	79	4	06.10-01.18	K9K896	; OE 8200682558		EPBMWT4-A022H	93854		
1.5 dCi	1461	80	4	08.13-01.18	K9K666, K9K667, K9K856, K9K858	; OE 8200682558		EPBMWT4-A022H	93854		
1.5 dCi 4x4	1461	80	4	08.13-01.18	K9K658, K9K856, K9K858, K9K898	6-Speed; OE 8200682558		EPBMWT4-A022H	93854		
1.5 dCi 4x4	1461	80	4	08.13-01.18	K9K898	; Type:HSMC		EPBMWT4-A019H	94808		
1.5 dCi 4x4	1461	81	4	10.10-01.18	K9K856, K9K858, K9K898			EPBMWT4-A022H	93854		
1.5 dCi 4x4	1461	81	4	10.10-01.18	K9K898	; Type:HSMC		EPBMWT4-A019H	94808		
1.5 dCi	1461	81	4	08.13-01.18	K9K658, K9K856, K9K858, K9K898	6-Speed; OE 8200682558		EPBMWT4-A022H	93854		
1.5 dCi	1461	81	4	08.13-01.18	K9K886, K9K898	; Type:HSM3, HSMC		EPBMWT4-A019H	94808		

DUSTER SUV VAN

1.5 dCi	1461	66	4	04.11-	K9K884, K9K892	; OE 8200682558		EPBMWT4-A022H	93854		
1.5 dCi	1461	66	4	04.11-	K9K892, K9K884	; Type:HSA6, HSM0, HSMG, HSMV; Type:HSA7		EPBMWT4-A019H	94808		
1.5 dCi 4x4	1461	66	4	04.11-	K9K884, K9K892	; OE 8200682558		EPBMWT4-A022H	93854		
1.5 dCi 4x4	1461	66	4	04.11-	K9K892, K9K884			EPBMWT4-A019H	94808		
1.5 dCi	1461	80	4	04.13-	K9K666, K9K856	; OE 8200682558		EPBMWT4-A022H	93854		
1.5 dCi 4x4	1461	80	4	04.13-	K9K658, K9K858	; OE 8200682558		EPBMWT4-A022H	93854		

LOGAN (LS_)

1.5 dCi	1461	50	4	01.06-	K9K792			EPBMWT6-V013H	92412		
1.5 dCi	1461	55	4	05.10-	K9K892			EPBMWT4-A019H	94808		
1.5 dCi	1461	63	4	09.07-	K9K796			EPBMWT6-V013H	92412		
1.5 dCi	1461	65	4	05.10-	K9K892			EPBMWT4-A019H	94808		

LOGAN EXPRESS (FS_)

1.5 dCi	1461	50	4	03.09-	K9K792			EPBMWT6-V013H	92412		
1.5 dCi	1461	55	4	05.10-	K9K892			EPBMWT4-A019H	94808		
1.5 dCi	1461	63	4	03.09-	K9K796			EPBMWT6-V013H	92412		
1.5 dCi	1461	65	4	05.10-	K9K892			EPBMWT4-A019H	94808		

LOGAN II

1.5 dCi / Blue dCi 75	1461	55	4	10.12-	K9K612, K9K626, K9K872	; OE 8200682558		EPBMWT4-A022H	93854		
-----------------------	------	----	---	--------	---------------------------	-----------------	--	---------------	-------	--	--



MAF
 l kW
 C
 Y
 I

Type-N°

Stock-N°

Plug In
Alternative
Type-N°Plug In
Subtype**DACIA****LOGAN II**

1.5 dCi	1461	66	4	10.12-	K9K612, K9K626	OE 8200682558	EPBMWT4-A022H	93854		
---------	------	----	---	--------	----------------	---------------	---------------	-------	--	--

LOGAN MCV (KS_)

1.5 dCi	1461	50	4	02.07-	K9K792		EPBMWT6-V013H	92412		
1.5 dCi	1461	55	4	05.10-	K9K892		EPBMWT4-A019H	94808		
1.5 dCi	1461	63	4	09.07-	K9K796		EPBMWT6-V013H	92412		
1.5 dCi	1461	65	4	05.10-	K9K892		EPBMWT4-A019H	94808		

LOGAN MCV II

1.5 dCi	1461	55	4	02.13-	K9K612, K9K626	OE 8200682558	EPBMWT4-A022H	93854		
1.5 dCi	1461	63	4	02.13-	K9K830, K9K838	OE 8200682558	EPBMWT4-A022H	93854		
1.5 dCi	1461	66	4	02.13-	K9K612, K9K626	OE 8200682558	EPBMWT4-A022H	93854		

LOGAN PICKUP (US_)

1.5 dCi	1461	50	4	03.08-	K9K792		EPBMWT6-V013H	92412		
1.5 dCi	1461	55	4	05.10-	K9K892		EPBMWT4-A019H	94808		
1.5 dCi	1461	63	4	03.08-	K9K796		EPBMWT6-V013H	92412		
1.5 dCi	1461	65	4	05.10-	K9K892		EPBMWT4-A019H	94808		

SANDERO

1.5 dCi	1461	50	4	11.08-	K9K792		EPBMWT6-V013H	92412		
1.5 dCi	1461	55	4	05.10-	K9K892		EPBMWT4-A019H	94808		
1.5 dCi	1461	63	4	11.08-	K9K796		EPBMWT6-V013H	92412		
1.5 dCi	1461	65	4	05.10-	K9K892		EPBMWT4-A019H	94808		

SANDERO II

1.5 dCi 75 / Blue dCi 75	1461	55	4	10.12-	K9K612, K9K626, K9K838, K9K872	OE 8200682558	EPBMWT4-A022H	93854		
1.5 dCi	1461	63	4	01.13-	K9K830	OE 8200682558	EPBMWT4-A022H	93854		
1.5 dCi	1461	66	4	10.12-	K9K612, K9K626	OE 8200682558	EPBMWT4-A022H	93854		

DAEWOO**KORANDO (KJ)**

2.0 16V	1998	94	4	02.99-	M161950		EPBMFN4-D040H	96545		
2.3	2295	103	4	01.99-02.01	E23		EPBMFN4-D040H	96545		
2.3	2295	105	4	01.99-	M161970		EPBMFN4-D040H	96545		

MUSSO (FJ)

2.3	2295	103	4	01.99-	M111970		EPBMFN4-D040H	96545		
-----	------	-----	---	--------	---------	--	---------------	-------	--	--

DODGE**AVENGER**

2.0 CRD	1968	103	4	06.07-08.10	ECD		EPBMFN5-D047H	91140		
---------	------	-----	---	-------------	-----	--	---------------	-------	--	--

CALIBER

2.0 CRD	1968	100	4	06.06-11.11	ECD		EPBMFN5-D047H	91140		
2.0 CRD	1968	103	4	06.06-08.09	ECD, ECE		EPBMFN5-D047H	91140		

JOURNEY

2.0 CRD	1968	100	4	06.08-12.11	ECE		EPBMFN5-D047H	91140		
2.0 CRD	1968	103	4	06.08-08.10	ECE		EPBMFN5-D047H	91140		



MAF



l kW
C
Y
I



Type-N°

Stock-N°

Plug In
Alternative
Type-N°

Plug In
Subtype

DS

DS 4 / DS 4 CROSSBACK

2.0 BlueHDi 150	1997	110	4	07.15-	AHR		EPBMWN4-A024H	90997		
2.0 BlueHDi 180	1997	133	4	07.15-	AHW		EPBMWN4-A024H	90997		

DS 5

1.6 BlueHDi 115	1560	85	4	06.15-	BHX		EPBMWT4-A026H	95537		
2.0 BlueHDi 150	1997	110	4	04.15-	AHR		EPBMWN4-A024H	90997		
2.0 Hybrid4 4x4	1997	120	4	04.15-	RHC		EPBMWT4-A028H	91236		
2.0 BlueHDi 180	1997	133	4	04.15-	AHW		EPBMWN4-A024H	90997		

FERRARI

360 (F131)

3.6 Modena	3586	294	8	03.99-12.04	F131B40		EPBMFT5-V031H	97525		
3.6	3586	294	8	02.00-08.05	F131B40		EPBMFT5-V031H	97525		

599 GTB/GTO

6.0 GTB	5999	456	12	06.06-12.12	F134FB61		EPBMFT5-V001P	93006		
---------	------	-----	----	-------------	----------	--	---------------	-------	--	--

FIAT

500 (312_)

0.9	964	48	2	09.12-	312A4000		EPBMFT4-V004H	90957		
1.3 D Multijet	1248	55	4	09.09-	169A1000		EPBMFN4-V017H	96226		
1.3 D Multijet	1248	70	4	09.09-	199B1000, 312B1000		EPBMFT4-V004H	90957		

500L (351_, 352_)

1.3 D Multijet	1248	62	4	09.12-	199B4000		EPBMFT4-V004H	90957		
1.3 D Multijet	1248	70	4	06.14-	330A1000		EPBMFT4-V004H	90957		
1.4	1368	70	4	09.12-	843A1000		EPBMFT4-V004H	90957		
1.6 D Multijet	1598	77	4	09.12-05.18	199B5000		EPBMFT4-V004H	90957		
1.6 D Multijet	1598	88	4	09.13-	955A3000, 940C1000		EPBMFT4-V004H	90957		

500X (334_)

1.3 D Multijet	1248	70	4	11.14-	55266963		EPBMFT4-V004H	90957		
1.6 D Multijet	1598	84	4	09.14-	55260384		EPBMFT4-V004H	90957		
1.6 D Multijet	1598	88	4	09.14-	55260384		EPBMFT4-V004H	90957		
2.0 D Multijet 4x4	1956	100	4	09.14-	55263087, 55263088		EPBMFT4-V004H	90957		
2.0 D Multijet 4x4	1956	103	4	09.14-	55263087, 55263088		EPBMFT4-V004H	90957		

BRAVO I (182_)

1.9 JTD 105	1910	77	4	12.98-10.01	182B4000		EPBMFT5-V017H	90311		
2.0 HGT 20V	1998	113	5	07.98-10.01	182B7000		EPBMFT5-V017H	90311	EPBMFT5-V001P	93006

BRAVO II (198_)

1.6 D Multijet	1598	66	4	03.08-12.14	198A6000		EPBMFT4-V004H	90957		
1.6 D Multijet	1598	77	4	09.07-12.14	198A3000, 844A3000		EPBMFT4-V004H	90957		
1.6 JTD	1598	77	4	03.08-12.14	198A3000		EPBMFT4-V004H	90957		
1.6 D Multijet	1598	88	4	03.08-12.14	198A2000		EPBMFT4-V004H	90957		
1.9 D Multijet	1910	66	4	04.07-12.08	192B5000		EPBMFN4-V017H	96226		



MAF



l kW
C
Y
I



Type-N°

Stock-N°

Plug In
Alternative
Type-N°

Plug In
Stock-N°

FIAT

BRAVO II (198_)

1.9 D Multijet	1910	85	4	11.06-12.09	192A1000, 192B4000		EPBMFN4-V017H	96226		
1.9 D Multijet	1910	88	4	04.07-12.14	192A8000		EPBMFN4-V017H	96226		
1.9 D Multijet	1910	110	4	04.07-12.14	937A5000		EPBMFN4-V017H	96226		
2.0 D Multijet	1956	120	4	09.08-12.14	844A2000, 198A8000		EPBMFT4-V004H	90957		
2.0 D Multijet	1956	121	4	09.08-12.14	198A5000		EPBMFT4-V004H	90957		

COUPE (175_)

2.0 20V	1998	113	5	04.98-08.00	182B3000		EPBMFT5-V017H	90311		
---------	------	-----	---	-------------	----------	--	---------------	-------	--	--

CROMA (194_)

1.8 16V	1796	103	4	02.06-	939A4000		EPBMFT4-V048H	95493		
1.9 D Multijet	1910	85	4	06.05-	939A7000		EPBMFN4-V026H	94497		
1.9 D Multijet	1910	85	4	06.05-12.10	939A7000		EPBMFN4-V010H	97588		
1.9 D Multijet	1910	88	4	06.05-12.11	939A1000		EPBMFN4-V026H	94497		
1.9 D Multijet	1910	88	4	06.05-12.10	939A1000	; Chass.<194AXB1B	EPBMFN4-V010H	97588		
1.9 MJTD	1910	88	4	04.06-12.11	939A1000		EPBMFN4-V026H	94497		
1.9 D Multijet	1910	100	4	12.05-	939A8000		EPBMFN4-V026H	94497		
1.9 D Multijet	1910	100	4	12.05-	939A8000		EPBMFN4-V010H	97588		
1.9 D Multijet	1910	110	4	06.05-12.11	939A2000		EPBMFN4-V026H	94497		
1.9 D Multijet	1910	110	4	06.05-12.10	939A2000	; Chass.<194AXC1B; Chass.<194AXC12	EPBMFN4-V010H	97588		
2.2 16V	2198	108	4	06.05-	194A1000		EPBMWT5-V023H	95103		
2.4 D Multijet	2387	147	5	06.05-	939A3000		EPBMFN4-V020H	90971		

DOBLO (119_, 223_)

1.3 JTD 16V	1248	51	4	05.04-12.06	188A9000		EPBMFT5-V029H	90502	EPBMFT5-V001P	93006
1.3 JTD 16V	1248	51	4	05.04-12.06	188A9000		EPBMFN4-V017H	96226	EPBMFT5-V001P	93006
1.3 D Multijet	1248	55	4	10.05-01.10	199A2000		EPBMFN4-V017H	96226		
1.3 JTD	1248	55	4	05.05-	199A2000		EPBMFN4-V017H	96226		
1.3 D Multijet	1248	62	4	10.05-	223A9000		EPBMFN4-V017H	96226		
1.3 JTD 16V Multijet	1248	62	4	08.06-	223A9000		EPBMFN4-V017H	96226		
1.9 JTD	1910	74	4	10.01-	182B9000, 223B2000	OE 51782033	EPBMFN4-V010H	97588		
1.9 JTD	1910	74	4	10.01-	223B2000		EPBMFN4-V026H	94497		
1.9 JTD	1910	74	4	02.02-	182B9000		EPBMFT5-V017H	90311		
1.9 JTD	1910	77	4	07.03-	223A7000, 223B1000		EPBMFN4-V026H	94497		
1.9 JTD	1910	77	4	02.04-	223A7000, 223B1000		EPBMFN4-V010H	97588		
1.9 JTD	1910	77	4	02.04-	223A7000		EPBMFT5-V017H	90311		
1.9 D Multijet	1910	88	4	10.05-	186A9000		EPBMFN4-V026H	94497		
1.9 D Multijet	1910	88	4	10.05-12.10	186A9000		EPBMFN4-V010H	97588		
1.9 JTD Multijet	1910	88	4	12.06-	186A9000		EPBMFN4-V026H	94497		
1.9 JTD Multijet	1910	88	4	12.06-	186A9000		EPBMFN4-V010H	97588		

DOBLO (263_)

1.3 D Multijet	1248	55	4	11.13-	263A6000		EPBMFT4-V004H	90957		
1.3 D Multijet	1248	55	4	11.13-	263A6000		EPBMFN4-V017H	96226		



MAF



l kW
C
Y
I



Type-N°

Stock-N°

Plug In
Alternative
Type-N°

Plug In
Subtype

FIAT

DOBLO (263_)

1.3 D Multijet	1248	59	4	03.16-	225A2000	Euro4	EPBMFN4-V017H	96226		
1.3 D Multijet	1248	59	4	03.16-	225A2000	; Euro5; Euro6	EPBMFT4-V004H	90957		
1.3 D Multijet	1248	66	4	02.10-	199A3000, 263A2000		EPBMFT4-V004H	90957		
1.3 D Multijet	1248	66	4	02.10-	199A3000, 263A2000		EPBMFN4-V017H	96226		
1.3 D Multijet	1248	66	4	02.10-	199A3000		EPBMFT4-V004H	90957		
1.3 D Multijet	1248	66	4	02.10-	199A3000		EPBMFN4-V017H	96226		
1.3 D Multijet	1248	66	4	02.10-	263A2000		EPBMFT4-V004H	90957		
1.3 D Multijet	1248	70	4	03.16-	330A1000	Euro4	EPBMFN4-V017H	96226		
1.3 D Multijet	1248	70	4	03.16-	330A1000	; Euro5; Euro6	EPBMFT4-V004H	90957		
1.6 D Multijet	1598	66	4	02.10-	263A4000, 263A5000	;	EPBMFT4-V004H	90957		
1.6 D Multijet	1598	66	4	02.10-	263A4000	;	EPBMFT4-V004H	90957		
1.6 D Multijet	1598	70	4	03.15-	263A7000		EPBMFT4-V004H	90957		
1.6 D Multijet	1598	74	4	02.10-	263A3000, 263A9000	;	EPBMFT4-V004H	90957		
1.6 D Multijet	1598	77	4	01.10-	198A3000, 263A8000	;	EPBMFT4-V004H	90957		
1.6 D Multijet	1598	88	4	02.16-	940C1000		EPBMFT4-V004H	90957		
2.0 D Multijet	1956	99	4	01.10-	263A1000		EPBMFT4-V004H	90957		

DUCATO (230_)

2.0 JTD	1997	62	4	10.01-04.02	RHV		EPBMWT5-A004H	91200		
2.8 JTD	2798	94	4	03.01-04.02	814043S		EPBMFT5-V008H	93715		
2.8 JTD 4x4	2798	94	4	10.01-04.02	814043S		EPBMFT5-V008H	93715		

DUCATO (244_)

2.0 JTD	1997	62	4	04.02-	RHV		EPBMWT5-A004H	91200		
2.8 JTD	2798	94	4	04.02-	814043S		EPBMFT5-V008H	93715		

DUCATO (250_, 290_)

115 Multijet 2.0 D	1956	85	4	06.11-	250A1000, 250A2000	; Euro5	EPBMFT4-V061H	94528		
100 Multijet 2.2 D	2198	74	4	07.06-	4HV		EPBMWT4-A001D	95860		
110 Multijet 2.3 D	2287	82	4	05.14-	F1AE3481G	; Euro5	EPBMFT4-V004H	90957		
110 Multijet 2.3 D	2287	83	4	10.11-	F1AE3481G		EPBMFT4-V061H	94528		
120 Multijet 2.3 D	2287	88	4	07.06-	F1AE0481D		EPBMFN4-V020H	90971		
120 Multijet 2.3 D	2287	88	4	07.06-	FPT	; Not for sequential manual transmission; Euro5	EPBMFT4-V061H	94528		
120 Multijet 2.3 D	2287	88	4	07.06-	FPT	; Sequential Manual Transmission; Euro5	EPBMFT4-V004H	90957		
120 Multijet 2.3 D 4x4	2287	88	4	03.10-	F1AE0481D	; Not for sequential manual transmission; Euro5	EPBMFT4-V061H	94528		
120 Multijet 2.3 D 4x4	2287	88	4	03.10-	F1AE0481D	; Sequential Manual Transmission; Euro5	EPBMFT4-V004H	90957		
130 Multijet 2.3 D	2287	93	4	01.10-	F1AE0481T	; Not for sequential manual transmission; Euro5	EPBMFT4-V061H	94528		



MAF



l kW
C
Y
I



Type-N°

Stock-N°

Plug In
Alternative
Type-N°

Plug In
Stock-N°

FIAT

DUCATO (250_, 290_)

130 Multijet 2.3 D	2287	93	4	01.10-	F1AE0481T	; Sequential Manual Transmission; Euro5	EPBMFT4-V004H	90957		
130 Multijet 2.3 D	2287	96	4	07.06-05.16	F1AE3481D, F1AGL411D	; 6-Speed; Euro5	EPBMFT4-V061H	94528		
130 Multijet 2.3 D	2287	96	4	06.11-	F1AE3481D, F1AE0481N, F1AGL411D	; 6-Speed; Sequential Manual Transmission; Euro5	EPBMFT4-V004H	90957		
130 Multijet 2.3 D	2287	96	4	06.11-	F1AGL411D	; Not for sequential manual transmission; Euro5	EPBMFT4-V061H	94528		
130 Multijet 2.3 D	2287	96	4	01.14-	F1AE0481N, F1AE3481D	; 6-Speed	EPBMFT4-V061H	94528		
130 Multijet 2.3 D	2287	96	4	04.16-05.16	F1AE0481N, F1AE3481D, F1AGL411D	; 6-Speed; Euro5	EPBMFT4-V061H	94528		
150 Multijet 2.3 D	2287	109	4	06.11-	F1AE3481E	; 6-Speed; 6-Speed; Euro5	EPBMFT4-V061H	94528		
150 Multijet 2.3 D	2287	109	4	06.11-	F1AE3481E	; 6-Speed; 6-Speed; Euro5	EPBMFT4-V004H	90957		
150 Multijet 2.3 D	2287	110	4	04.15-	F1AGL411A, F1AGL411C	; Not for sequential manual transmission; 6-Speed; Euro5	EPBMFT4-V061H	94528		
150 Multijet 2.3 D	2287	110	4	04.15-	F1AGL411C	; Sequential Manual Transmission; 6-Speed; Euro5	EPBMFT4-V004H	90957		
140 Natural Power	2999	100	4	04.09-	F1CFA401A		EPBMFT4-V061H	94528		
150 Multijet 3.0 D	2999	107	4	04.10-	F1CE3481N		EPBMFN4-V020H	90971		
160 Multijet 3.0 D	2999	115	4	10.06-	F1CE0481D		EPBMFN4-V020H	90971		
160 Multijet 3.0 D	2999	115	4	07.06-12.11	F1CE3481M		EPBMFT4-V061H	94528		
160 Multijet 3.0 D	2999	116	4	07.06-	F1CE0481D, F1CE3481M		EPBMFT4-V061H	94528		
180 Multijet 3.0 D	2999	130	4	06.11-	F1CE3481E		EPBMFT4-V061H	94528		

FIORINO BOX BODY/MPV (225_)

1.3 D Multijet	1248	59	4	07.15-	225A2000		EPBMFT4-V004H	90957		
1.3 D Multijet	1248	70	4	07.09-	199B1000		EPBMFT4-V004H	90957		
1.3 D Multijet	1248	70	4	07.09-	330A1000	; Euro5	EPBMFT4-V004H	90957		

FREEMONT (345_)

2.0 JTD	1956	100	4	08.11-	939B5000		EPBMFT4-V004H	90957		
2.0 JTD	1956	103	4	08.11-	939B5000, 940A5000		EPBMFT4-V004H	90957		
2.0 JTD	1956	120	4	08.11-	939B5000		EPBMFT4-V004H	90957		
2.0 JTD 4x4	1956	120	4	08.11-	939B5000		EPBMFT4-V004H	90957		
2.0 JTD	1956	125	4	08.11-	939B5000		EPBMFT4-V004H	90957		
2.0 JTD 4x4	1956	125	4	08.11-	939B5000		EPBMFT4-V004H	90957		

GRANDE PUNTO (199_)

1.3 D Multijet	1248	51	4	07.08-	199B2000		EPBMFN4-V017H	96226		
1.3 D Multijet	1248	55	4	10.05-	199A2000		EPBMFN4-V017H	96226		
1.3 JTD Multijet	1248	55	4	02.06-06.13	199A2000		EPBMFN4-V017H	96226		
1.3 D Multijet	1248	56	4	06.09-	199A2000	Euro4	EPBMFN4-V017H	96226		
1.3 D Multijet	1248	56	4	06.09-	199A2000	; Euro5	EPBMFT4-V004H	90957		



MAF



l kW
C
Y
I



Type-Nº

Stock-Nº

Plug In
Alternative
Type-Nº

Plug In
Subtype

FIAT

GRANDE PUNTO (199_)

1.3 D Multijet	1248	62	4	04.10-	223A9000, 199B4000		EPBMFT4-V004H	90957		
1.3 D Multijet	1248	66	4	10.05-	199A3000		EPBMFN4-V017H	96226		
1.3 JTD Multijet	1248	66	4	02.06-08.10	199A3000		EPBMFN4-V017H	96226		
1.6 D Multijet	1598	88	4	07.08-	955A3000		EPBMFT4-V004H	90957		
1.9 D Multijet	1910	85	4	06.06-12.09	939A7000		EPBMFN4-V026H	94497		
1.9 D Multijet	1910	85	4	06.06-12.07	939A7000	; Chass.<1402090	EPBMFN4-V010H	97588		
1.9 D Multijet	1910	88	4	10.05-	939A1000		EPBMFN4-V026H	94497		
1.9 D Multijet	1910	88	4	10.05-12.07	939A1000	; Chass.<0398346	EPBMFN4-V010H	97588		
1.9 D Multijet	1910	88	4	12.07-	939A1000		EPBMFN4-V010H	97588		
1.9 D Multijet	1910	96	4	10.05-	199A5000		EPBMFN4-V026H	94497		
1.9 D Multijet	1910	96	4	10.05-12.07	199A5000	; Chass.<0398346	EPBMFN4-V010H	97588		
1.9 D Multijet	1910	96	4	12.07-	199A5000		EPBMFN4-V010H	97588		

IDEA (350_)

1.3 D Multijet	1248	51	4	01.04-11.10	188A9000		EPBMFT5-V029H	90502	EPBMFT5-V001P	93006
1.3 D Multijet	1248	66	4	10.05-	199A3000		EPBMFN4-V017H	96226		
1.3 D Multijet	1248	70	4	05.08-12.12	199B1000	Euro4	EPBMFN4-V017H	96226		
1.3 D Multijet	1248	70	4	05.08-12.12	199B1000	; Euro5	EPBMFT4-V004H	90957		
1.6 D Multijet	1598	88	4	05.08-	350A2000		EPBMFT4-V004H	90957		
1.9 JTD	1910	74	4	01.04-	188B2000		EPBMFN4-V026H	94497		
1.9 JTD	1910	74	4	01.04-10.07	188B2000		EPBMFN4-V010H	97588		

LINEA (323_, 110_)

1.3 JTD Multijet	1248	63	4	10.06-	199A3000		EPBMFN4-V017H	96226		
1.3 D Multijet	1248	66	4	06.07-	199A3000		EPBMFN4-V017H	96226		
1.3 D Multijet	1248	70	4	09.09-	199A3000		EPBMFT4-V004H	90957		
1.6 D Multijet	1598	77	4	06.09-	198A3000		EPBMFT4-V004H	90957		

MAREA (185_)

1.9 TD 100	1910	74	4	09.96-06.03	182A7000, 182B9000		EPBMFT5-V017H	90311		
1.9 JTD 105	1910	77	4	12.98-12.02	182B4000		EPBMFT5-V017H	90311		
1.9 JTD 110	1910	81	4	09.00-04.02	186A6000		EPBMFT5-V039H	90466		
2.0 150 20V	1998	110	5	01.01-05.02	185A8000		EPBMFT5-V017H	90311		
2.0 155 20V	1998	113	5	04.99-01.01	182B7000		EPBMFT5-V017H	90311	EPBMFT5-V001P	93006
2.4 JTD 130	2387	96	5	04.99-12.00	185A6000		EPBMFT5-V039H	90466	EPBMFT5-V001P	93006

MULTIPLA (186_)

1.9 JTD 105	1910	77	4	04.99-12.00	182B4000		EPBMFT5-V039H	90466	EPBMFT5-V001P	93006
1.9 JTD 110	1910	81	4	03.01-07.02	186A6000		EPBMFT5-V039H	90466		
1.9 JTD 115	1910	85	4	07.02-10.03	186A8000		EPBMFT5-V039H	90466		
1.9 JTD 115	1910	85	4	07.02-06.10	186A8000	Euro4	EPBMFN4-V017H	96226		
1.9 JTD	1910	88	4	04.02-06.10	186A9000		EPBMFN4-V017H	96226		

PALIO (178_)

1.3 JTD Multijet	1248	51	4	06.03-	188A9000		EPBMFT5-V029H	90502		
1.3 JTD Multijet	1248	51	4	06.03-	188A9000		EPBMFN4-V017H	96226		



MAF



l kW
C
Y
I



Type-N°

Stock-N°

Plug In
Alternative
Type-N°

Plug In
stock-N°

FIAT

PALIO (178_)

1.7 TD	1698	53	4	09.01-	176A5000		EPBMFN4-V017H	96226		
--------	------	----	---	--------	----------	--	---------------	-------	--	--

PANDA (169_)

1.2 4x4	1242	51	4	11.09-	169A4000		EPBMFT4-V004H	90957		
1.2	1242	51	4	03.10-08.13	169A4000		EPBMFT4-V004H	90957		
1.2 LPG	1242	51	4	11.10-08.13	169A4000		EPBMFT4-V004H	90957		
1.3 D Multijet	1248	51	4	09.03-09.10	188A9000, 188A8000		EPBMFT5-V029H	90502	EPBMFT5-V001P	93006
1.3 D Multijet	1248	51	4	03.04-	188A8000		EPBMFN4-V017H	96226		
1.3 D Multijet 4x4	1248	51	4	10.04-	188A8000		EPBMFN4-V017H	96226		
1.3 D Multijet 4x4	1248	51	4	09.05-09.10	188A9000, 188A8000		EPBMFT5-V029H	90502	EPBMFT5-V001P	93006
1.3 D Multijet	1248	55	4	01.06-	169A1000		EPBMFN4-V017H	96226		
1.3 D Multijet	1248	55	4	06.06-08.13	169A1000, 169A5000		EPBMFN4-V017H	96226		
1.3 D Multijet 4x4	1248	55	4	01.06-	169A1000		EPBMFN4-V017H	96226		
1.3 JTD Multijet 4x4	1248	55	4	09.10-08.13	169A1000, 169A5000		EPBMFT4-V004H	90957		
1.3 JTD Multijet 4x4	1248	55	4	09.10-08.13	169A1000, 169A5000		EPBMFT5-V029H	90502		

PANDA (312_, 319_)

1.3 D Multijet	1248	55	4	02.12-12.15	199A1000	; Euro5	EPBMFT4-V004H	90957		
1.3 D Multijet	1248	55	4	02.12-	199A9000		EPBMFT4-V004H	90957		
1.3 D Multijet 4x4	1248	55	4	06.12-	199A1000	; Euro5	EPBMFT4-V004H	90957		
1.3 D Multijet 4x4	1248	55	4	06.12-	199A9000		EPBMFT4-V004H	90957		
1.3 D Multijet 4x4	1248	59	4	06.14-	199A9000, 225A2000, 312B2000	; Euro5; Euro6	EPBMFT4-V004H	90957		
1.3 D Multijet 4x4	1248	59	4	06.14-	312A8000		EPBMFT4-V004H	90957		
1.3 D Multijet	1248	59	4	12.15-	312B2000, 225A2000	; Euro5; Euro6	EPBMFT4-V004H	90957		
1.3 D Multijet	1248	70	4	04.15-12.15	199B1000	; Euro5	EPBMFT4-V004H	90957		
1.3 D Multijet	1248	70	4	04.15-	330A1000, 312B1000		EPBMFT4-V004H	90957		
1.3 D Multijet 4x4	1248	70	4	04.15-	199B1000, 330A1000	; Euro5	EPBMFT4-V004H	90957		
1.3 D Multijet 4x4	1248	70	4	04.15-	312B1000		EPBMFT4-V004H	90957		

PUNTO (188_)

1.3 JTD	1248	51	4	06.03-10.05	188A9000		EPBMFT5-V029H	90502	EPBMFT5-V001P	93006
1.3 JTD 16V	1248	51	4	06.03-12.10	188A9000		EPBMFT5-V029H	90502	EPBMFT5-V001P	93006
1.9 JTD 80	1910	59	4	09.99-03.12	188A2000		EPBMFT5-V017H	90311		
1.9 JTD	1910	63	4	02.00-10.09	188A7000		EPBMFT5-V017H	90311		
1.9 JTD	1910	74	4	08.03-01.06	188B2000		EPBMFT5-V017H	90311		

PUNTO (199_)

1.3 D Multijet	1248	51	4	07.08-02.12	199B2000	Euro4, Euro5	EPBMFN4-V017H	96226		
1.3 D Multijet	1248	55	4	04.08-	199A2000, 199A9000	; Euro5	EPBMFT4-V004H	90957		
1.3 D Multijet	1248	55	4	10.09-02.12	199A2000, 199A9000	Euro5;	EPBMFN4-V017H	96226		
1.3 D Multijet	1248	55	4	03.09-02.12	199A2000, 199A9000		EPBMFN4-V017H	96226		
1.3 D Multijet	1248	55	4	03.12-	199A2000, 199A9000	Euro4	EPBMFN4-V017H	96226		



MAF



l kW
C
Y
I



Type-N°

Stock-N°

Plug In
Alternative
Type-N°

Plug In
Subtype

FIAT

PUNTO (199_)

1.3 D Multijet	1248	56	4	09.10-	199A2000, 199A9000	Euro4	EPBMFN4-V017H	96226		
1.3 D Multijet	1248	56	4	09.10-	199A2000, 199A9000	; Euro5	EPBMFT4-V004H	90957		
1.3 D Multijet	1248	59	4	12.13-	199B8000		EPBMFT4-V004H	90957		
1.3 D Multijet	1248	62	4	10.09-02.12	223A9000, 199B4000	Euro4, Euro5;	EPBMFN4-V017H	96226		
1.3 D Multijet	1248	62	4	10.09-02.12	223A9000, 199B4000	; Euro5;	EPBMFT4-V004H	90957		
1.3 D Multijet	1248	62	4	03.12-	199B4000	Euro4	EPBMFN4-V017H	96226		
1.3 D Multijet	1248	62	4	03.12-	199B4000	; Euro5	EPBMFT4-V004H	90957		
1.3 D Multijet	1248	66	4	10.09-	199A3000	Euro5;	EPBMFN4-V017H	96226		
1.3 D Multijet	1248	66	4	03.09-02.12	199A3000	Euro4	EPBMFN4-V017H	96226		
1.3 D Multijet	1248	66	4	03.09-02.12	199A3000	; Euro5	EPBMFT4-V004H	90957		
1.3 JTD Multijet	1248	66	4	05.18-	955B2000	Euro4	EPBMFN4-V017H	96226		
1.3 JTD Multijet	1248	66	4	05.18-	955B2000	; Euro5	EPBMFT4-V004H	90957		
1.3 D Multijet	1248	70	4	03.09-	199B1000		EPBMFT4-V004H	90957		
1.3 D Multijet	1248	70	4	10.09-02.12	199B1000	Euro4	EPBMFN4-V017H	96226		
1.3 D Multijet	1248	70	4	10.09-02.12	199B1000	Euro5;	EPBMFN4-V017H	96226		
1.3 D Multijet	1248	70	4	03.12-	199B1000, 330A1000	; Euro5	EPBMFT4-V004H	90957		
1.6 D Multijet	1598	88	4	10.09-02.12	955A3000		EPBMFT4-V004H	90957		

QUBO (225_)

1.3 D Multijet	1248	59	4	07.15-	225A2000	; Euro6	EPBMFT4-V004H	90957		
1.3 D Multijet	1248	70	4	07.10-	199B1000		EPBMFT4-V004H	90957		

SCUDO (220_)

1.9 D	1868	51	4	10.01-02.04	WJY, WJZ		EPBMWT5-A003H	93842		
2.0 JTD	1997	69	4	01.04-06.04	RHX		EPBMWT5-A003H	93842		
2.0 JTD	1997	69	4	10.99-12.06	RHX		EPBMFN4-V017H	96226		
2.0 JTD	1997	80	4	12.99-12.06	RHZ		EPBMWT5-A003H	93842		
2.0 JTD	1997	80	4	12.99-12.06	RHZ		EPBMFN4-V017H	96226		
2.0 JTD 16V	1997	80	4	05.99-02.04	RHK, RHM, RHW		EPBMWT5-A003H	93842		

SCUDO (270_, 272_)

1.6 D Multijet	1560	66	4	01.07-	9HU, 9H07, 9HM		EPBMFT5-A001H	93740		
2.0 D Multijet	1997	88	4	01.07-	RHK		EPBMWT4-A008H	90627		
2.0 D Multijet	1997	94	4	04.11-	RH02		EPBMWN4-A024H	90997		
2.0 D Multijet	1997	100	4	01.07-	RHR		EPBMWT4-A008H	90627		
2.0 D Multijet	1997	120	4	07.10-	RH02, RHH		EPBMWN4-A024H	90997		

SEDICI (189_)

1.9 D Multijet	1910	88	4	06.06-10.11	D19AA		EPBMFN4-V026H	94497		
1.9 D Multijet 4x4	1910	88	4	06.06-10.11	D19AA		EPBMFN4-V026H	94497		
2.0 D Multijet	1956	99	4	06.06-10.14	D20AA		EPBMFT4-V004H	90957		
2.0 D Multijet 4x4	1956	99	4	06.06-10.14	D20AA		EPBMFT4-V004H	90957		

SIENA (178_, 172_) | ALBEA

1.3 JTD	1248	51	4	09.03-12.09	188A9000		EPBMFT5-V029H	90502		
---------	------	----	---	-------------	----------	--	---------------	-------	--	--



MAF



l kW
C
Y
I



Type-N°

Stock-N°

Plug In
Alternative
Type-N°

Plug In
Subtype

FIAT

SIENA (178_, 172_) | ALBEA

1.3 JTD	1248	51	4	09.03-12.09	188A9000		EPBMFN4-V017H	96226		
---------	------	----	---	-------------	----------	--	---------------	-------	--	--

STILO (192_)

1.9 JTD	1910	59	4	01.03-08.08	192A3000		EPBMFT5-V039H	90466		
1.9 D	1910	66	4	09.04-08.08	192B5000		EPBMFN4-V017H	96226		
1.9 JTD	1910	66	4	09.04-11.06	192B5000		EPBMFN4-V017H	96226		
1.9 JTD	1910	85	4	01.03-08.08	192A1000		EPBMFT5-V039H	90466		
1.9 JTD	1910	85	4	01.03-08.08	937A7000		EPBMFN4-V017H	96226		
1.9 D Multijet	1910	88	4	09.05-08.08	192A8000		EPBMFN4-V017H	96226		
1.9 JTD	1910	88	4	09.05-08.08	192A8000		EPBMFN4-V017H	96226		
1.9 D Multijet	1910	110	4	09.05-08.08	937A5000		EPBMFN4-V017H	96226		
1.9 JTD	1910	110	4	09.05-08.08	937A5000		EPBMFN4-V017H	96226		

STRADA PICKUP (178_)

1.3 D Multijet	1248	62	4	05.06-	223A9000		EPBMFN4-V017H	96226		
1.3 D Multijet	1248	70	4	10.10-	199B1000		EPBMFT4-V004H	90957		

TIPO (356_) | EGEA

1.3 D	1248	70	4	03.16-	199B1000, 55266963, 55283775	Euro4	EPBMFT4-V004H	90957		
-------	------	----	---	--------	------------------------------------	-------	---------------	-------	--	--

ULYSSE (179_)

2.0 JTD	1997	79	4	05.03-08.06	RHM		EPBMWT5-A005H	93383		
2.0 JTD	1997	80	4	10.99-12.00	RHZ		EPBMWT5-A003H	93842		
2.0 JTD 16V	1997	80	4	05.99-08.02	RHW		EPBMWT5-A003H	93842		
2.0 JTD	1997	80	4	08.02-08.06	RHW		EPBMWT5-A005H	93383		
2.0 D Multijet	1997	88	4	05.06-06.11	RHK		EPBMWT4-A008H	90627		
2.0 D Multijet	1997	100	4	05.06-06.11	RHR		EPBMWT4-A008H	90627		
2.2 JTD	2179	94	4	08.02-08.06	4HW		EPBMWT5-A005H	93383		
2.2 D Multijet	2179	125	4	03.08-06.11	4HS, 4HT		EPBMWT4-A008H	90627		

FORD

B-MAX (JK)

1.0 EcoBoost	998	74	3	10.12-	SFJA, SFJB, SFJC, SFJD		EPBMWT4-V003D	94395		
1.0 EcoBoost	998	88	3	10.12-	M1JA		EPBMWT4-V003D	94395		
1.5 TDCi	1499	55	4	10.12-	UGJC, UGJG, XUJA, XUJB		EPBMWT4-V003D	94395		
1.6 TDCi	1560	70	4	10.12-	T3JB		EPBMWT4-V003D	94395		

C-MAX (DM2)

1.6 TDCi	1560	66	4	02.07-09.10	GPDA, HHDA, HHDB		EPBMWT4-V002D	95695		
1.6 TDCi	1560	74	4	03.07-09.10	G8DC, MTDA		EPBMWT4-V002D	95695		
1.6 TDCi	1560	80	4	02.07-09.10	G8DA, G8DB, G8DD		EPBMWT4-V002D	95695		
1.8 TDCi	1753	85	4	02.07-09.10	KKDA		EPBMWT4-V002D	95695		
2.0 TDCi	1997	81	4	02.08-09.10	IXDA		EPBMWT4-V002D	95695		
2.0 TDCi	1997	98	4	02.07-09.10	G6DC, G6DE, G6DF		EPBMWT4-V002D	95695		
2.0 TDCi	1997	100	4	02.07-09.10	G6DA, G6DB, G6DD, G6DG		EPBMWT4-V002D	95695		



MAF



l kW
C
Y
I



Type-Nº

Stock-Nº

Plug In
Alternative
Type-Nº

Plug In
Subtype

FORD

C-MAX II (DXA/CB7, DXA/CEU)

1.0 EcoBoost	998	74	3	10.12-	M2DA, SFDA		EPBMWT4-V002D	95695		
1.0 EcoBoost	998	92	3	10.12-	B7DA, M1DA, M1DD		EPBMWT4-V002D	95695		
1.6 TDCi	1560	70	4	12.10-	T3DA, T3DB		EPBMWT4-V002D	95695		
1.6 TDCi	1560	85	4	12.10-	T1DA, T1DB		EPBMWT4-V002D	95695		
1.6 Ti	1596	63	4	12.10-04.11	XTDA		EPBMWT4-V002D	95695		
1.6 Ti	1596	77	4	12.10-04.11	IQDA, IQDB		EPBMWT4-V002D	95695		
1.6 Flexifuel	1596	88	4	02.11-04.11	MUDA, MUDD		EPBMWT4-V002D	95695		
1.6 Ti	1596	92	4	12.10-04.11	PNDA		EPBMWT4-V002D	95695		
1.6 EcoBoost	1596	110	4	12.10-	JQDA, JQDB		EPBMWT4-V002D	95695		
1.6 EcoBoost	1596	134	4	12.10-	JTDA, JTDB		EPBMWT4-V002D	95695		
2.0 TDCi	1997	85	4	02.11-	TYDA		EPBMWT4-V002D	95695		
2.0 TDCi	1997	100	4	02.11-	UKDB		EPBMWT4-V002D	95695		
2.0 TDCi	1997	103	4	04.10-	UFDB		EPBMWT4-V002D	95695		
2.0 TDCi	1997	120	4	12.10-	TXDB		EPBMWT4-V002D	95695		

COUGAR (EC_)

2.0 16V	1988	96	4	08.98-12.01	EDBA, EDBB, EDBC, EDBD		EPBMFT6-A026H	93281		
---------	------	----	---	-------------	------------------------	--	---------------	-------	--	--

ESCORT CLASSIC (AAL, ABL, ANL)

1.8 TD	1753	66	4	02.99-07.00	RFD, RFK		EPBMWN4-A011H	96418		
--------	------	----	---	-------------	----------	--	---------------	-------	--	--

ESCORT VI (GAL, AAL, ABL, AVL, ALL, AFL, ANL)

1.3	1299	44	4	08.95-01.99	J4B, J6A		EPBMWN4-A012H	96882		
1.8 Turbo D	1753	51	4	12.95-06.01	RVA	Type:55; Type:75	EPBMWN4-A011H	96418		
1.8 Turbo D	1753	51	4	04.96-02.99	RVA		EPBMWN4-A011H	96418		
1.8 TD	1753	66	4	01.95-02.99	RFD, RFK		EPBMWN4-A011H	96418		
1.8 16V	1796	85	4	09.95-02.99	RKC		EPBMWN4-A011H	96418		
1.8 16V XR3i	1796	85	4	10.95-08.98	RKC		EPBMWN4-A011H	96418		

FIESTA III (GFJ, F3L, F5L, J5_, J3_)

1.0	1001	33	4	08.95-12.95	TLB		EPBMWN4-A012H	96882		
1.1	1119	37	4	08.95-12.95	G6A		EPBMWN4-A012H	96882		
1.1	1119	40	4	08.95-12.95	GUD, GUE		EPBMWN4-A012H	96882		
1.3	1299	44	4	08.95-12.95	J6B		EPBMWN4-A012H	96882		
1.3 Cat	1299	44	4	08.95-01.97	J6B		EPBMWN4-A012H	96882		
1.3	1299	44	4	02.96-10.98	J4C		EPBMWN4-A012H	96882		

FIESTA IV (JA_, JB_)

1.25 i 16V	1242	55	4	08.95-12.99	DHA, DHB, DHC, DHD, DHE, DHF, DHG		EPBMWN4-A012H	96882		
1.3 i	1299	37	4	08.95-10.98	JJA, JJC, JJE, JJJ, JJK, JJM		EPBMWN4-A012H	96882		
1.3 i	1299	44	4	08.95-10.98	J4C, J4J, J4L, J4Q, J4R, J4T, JBC		EPBMWN4-A012H	96882		

FIESTA V (JH_, JD_)

1.4 TDCi	1399	50	4	10.03-12.10	F6JA, F6JB		EPBMWT4-A009H	92423		
1.4 TDCi	1399	50	4	10.03-10.05	F6JA	; Euro3	EPBMWT6-A006H	94034		
1.6 TDCi	1560	66	4	04.07-09.09	HHJA, HHJB		EPBMFT5-A001H	93740		



MAF



l kW
C
Y
I



Type-Nº

Stock-Nº

Plug In
Alternative
Type-Nº

Plug In
Stock-Nº

FORD

FIESTA VI (CB1, CCN)

1.0 EcoBoost	998	74	3	01.13-	SFJA, SFJB, SFJC, SFJD		EPBMWT4-V003D	94395		
1.0 EcoBoost	998	92	3	09.12-	M1JE, M1JH		EPBMWT4-V003D	94395		
1.4 TDCi	1399	50	4	01.09-	F6JB, F6JD		EPBMWT4-A009H	92423		
1.4 TDCi	1399	50	4	01.09-	F6JB, F6JD		EPBMWT4-V003D	94395		
1.4 TDCi	1399	51	4	07.10-	F6JB		EPBMWT4-V003D	94395		
1.4 TDCi	1399	51	4	07.10-	F6JD, KWJA		EPBMWT4-A009H	92423		
1.5 TDCi	1499	55	4	09.12-	UGJC, XUJA, XUJB		EPBMWT4-V003D	94395		
1.6 TDCi	1560	55	4	06.08-	HHJF, UBJA		EPBMWT4-V003D	94395		
1.6 TDCi	1560	66	4	06.08-	HHJC, HHJD, HHJE		EPBMWT4-V003D	94395		
1.6 TDCi	1560	70	4	02.10-	T3JA, TZJA, TZJB		EPBMWT4-V003D	94395		
1.6 Ti	1596	88	4	06.08-	HXJA		EPBMWN6-A001D	91743		

FOCUS (DAW, DBW, DFW, DNW)

1.8 TDCi	1753	74	4	08.02-11.04	FFDA		EPBMFT6-A026H	93281		
1.8 TDCi	1753	85	4	03.01-11.04	F9DA, F9DB		EPBMFT6-A026H	93281		
1.8 16V	1796	85	4	02.99-11.04	EYDB, EYDC, EYDD, EYDE, EYDF, EYDG, EYDI, EYDJ, EYDL		EPBMFT6-A026H	93281		
2.0 16V	1988	96	4	02.99-11.04	EDDB, EDDC, EDDD, EDDF		EPBMFT6-A026H	93281		
ST170	1988	127	4	03.02-11.04	ALDA		EPBMFT6-A026H	93281		

FOCUS C-MAX (DM2)

1.6 TDCi	1560	66	4	02.05-03.07	HHDA, HHDB		EPBMFT5-A001H	93740		
1.6 TDCi	1560	66	4	02.05-03.07	HHDA, HHDB		EPBMWT4-V002D	95695		
1.6 TDCi	1560	80	4	10.03-03.07	G8DA, G8DB		EPBMFT5-A001H	93740		
1.6 TDCi	1560	80	4	10.03-03.07	G8DA, G8DB		EPBMWT4-V002D	95695		
1.6 Ti	1596	85	4	08.04-03.07	HXD		EPBMWN6-A001D	91743		
1.8 TDCi	1753	85	4	04.05-03.07	KKDA, KKDB		EPBMWN4-V002H	92462		
1.8 TDCi	1753	85	4	01.05-03.07	KKDA, KKDB		EPBMWT4-V002D	95695		
2.0 TDCi	1997	98	4	10.03-03.07	G6DC, G6DE, G6DF		EPBMWT4-A008H	90627		
2.0 TDCi	1997	100	4	10.03-02.07	G6DA, G6DB, G6DD, G6DG		EPBMWT4-A008H	90627		

FOCUS II (DA_, HCP, DP, DB_, FCH, DH, FFS, DS)

1.6 TDCi	1560	66	4	01.05-01.08	GPDA, GPDB, GPDC, HHDA, HHDB		EPBMFT5-A001H	93740		
1.6 TDCi	1560	66	4	12.07-09.12	GPDA, GPDB, GPDC, HHDA, HHDB		EPBMWT4-V002D	95695		
1.6 TDCi	1560	74	4	04.07-09.12	G8DC, MTDA		EPBMWT4-V002D	95695		
1.6 TDCi	1560	80	4	04.05-01.08	G8DA, G8DB, G8DD, G8DE, G8DF		EPBMFT5-A001H	93740		
1.6 TDCi	1560	80	4	04.05-09.12	G8DA, G8DB		EPBMWT4-V002D	95695		
1.6 TDCi	1560	81	4	12.07-01.08	G8DA		EPBMFT5-A001H	93740		
1.6 TDCi	1560	81	4	12.07-09.12	G8DA		EPBMWT4-V002D	95695		
1.6	1596	74	4	07.04-07.11	HWDA, HWDB, SHDA, SHDB, SHDC		EPBMWN6-A001D	91743		
1.6 Ti	1596	85	4	04.05-01.08	HXDA, HXDB, SIDA		EPBMWN6-A001D	91743		



MAF
 C
 kW
 I

Type-N°

Stock-N°

Plug In
Alternative
Type-N°Plug In
Subtype**FORD****FOCUS II (DA_, HCP, DP, DB_, FCH, DH, FFS, DS)**

1.6 LPG	1596	85	4	10.09-07.11	SIDA		EPBMWN6-A001D	91743		
1.8 TDCi	1753	85	4	04.05-12.07	KKDA		EPBMWN4-V002H	92462		
1.8 TDCi	1753	85	4	01.05-09.12	KKDA		EPBMWT4-V002D	95695		
2.0 TDCi	1997	81	4	02.08-07.11	IXDA		EPBMWT4-V002D	95695		
2.0 TDCi	1997	98	4	07.04-01.08	G6DE, G6DF		EPBMWT4-A008H	90627		
2.0 TDCi	1997	100	4	04.05-01.08	G6DA, G6DB, G6DD, G6DG		EPBMWT4-A008H	90627		
2.0 TDCi	1997	100	4	01.08-09.12	G6DA, G6DB, G6DD		EPBMWT4-V002D	95695		
2.0	1999	107	4	04.05-07.11	AODA, AODB, AODE		EPBMFT6-A026H	93281		
2.5 ST	2522	166	5	10.05-07.11	HYDA		EPBMFT5-V021H	95278		

FOCUS III

1.0 EcoBoost	998	74	3	02.12-	M2DA, M2DB, M2DC, SFDB		EPBMWT4-V002D	95695		
1.0 EcoBoost	998	92	3	02.12-	M1DA, M1DC, M1DD		EPBMWT4-V002D	95695		
1.6 TDCi	1560	70	4	07.10-	T3DA, T3DB		EPBMWT4-V002D	95695		
1.6 TDCi ECONetic	1560	77	4	05.12-	NGDA, NGDB		EPBMWT4-V002D	95695		
1.6 TDCi	1560	85	4	07.10-	T1DA, T1DB		EPBMWT4-V002D	95695		
1.6 Ti	1596	77	4	07.10-	IQDB		EPBMWN6-A001D	91743		
1.6 Flexifuel	1596	88	4	07.10-	MUDA		EPBMWN6-A001D	91743		
1.6 Flexifuel	1596	88	4	07.10-	MUDA		EPBMWT4-V002D	95695		
1.6 Ti	1596	92	4	07.10-	PNDA, PNDD		EPBMWN6-A001D	91743		
1.6 EcoBoost	1596	110	4	07.10-	JQDA, JQDB, YUDA		EPBMWT4-V002D	95695		
1.6 Flexifuel	1596	110	4	07.13-	YUDA		EPBMWT4-V002D	95695		
1.6 EcoBoost	1596	134	4	07.10-	JTDA, JTDB		EPBMWT4-V002D	95695		
2.0 TDCi	1997	85	4	07.10-	TYDA		EPBMWT4-V002D	95695		
2.0 TDCi	1997	100	4	07.10-	UKDB		EPBMWT4-V002D	95695		
2.0 TDCi	1997	103	4	07.10-	UFDB		EPBMWT4-V002D	95695		
2.0 TDCi	1997	120	4	07.10-	TXDB		EPBMWT4-V002D	95695		

FUSION (JU_)

1.4 TDCi	1399	50	4	08.02-12.12	F6JA, F6JB		EPBMWT4-A009H	92423		
1.4 TDCi	1399	50	4	08.02-10.05	F6JA		EPBMWT6-A006H	94034		
1.6 TDCi	1560	66	4	11.04-12.12	HHJA, HHJB		EPBMFT5-A001H	93740		

GALAXY (WGR)

1.9 TDI	1896	66	4	03.95-09.97	1Z		EPBMWN6-D029H	90628		
1.9 TDI	1896	66	4	10.97-05.06	ANU, 1Z		EPBMFN5-D005H	92204	EPBMFN5-D002P	91609
1.9 TDI	1896	81	4	08.97-09.97	AFN		EPBMWN6-D029H	90628		
1.9 TDI	1896	81	4	10.97-04.00	AFN		EPBMFN5-D005H	92204	EPBMFN5-D002P	91609
1.9 TDI	1896	85	4	04.00-05.06	AUY		EPBMFN5-D005H	92204	EPBMFN5-D002P	91609
1.9 TDI	1896	96	4	02.03-05.06	ASZ		EPBMFN5-D002H	91692	EPBMFN5-D002P	91609
1.9 TDI	1896	110	4	05.05-05.06	BTB		EPBMFN5-D002H	91692	EPBMFN5-D002P	91609
2.0 i	1998	85	4	11.95-03.00	NSE, ZVSA		EPBMWN4-A011H	96418		



MAF



l kW
C
Y
I



Type-N°

Stock-N°

Plug In
Alternative
Type-N°

Plug In
Subtype

FORD

GALAXY (WGR)

2.3 16V	2295	107	4	01.97-03.00	E5SA, Y5B		EPBMWN4-A011H	96418		
2.8 V6	2792	150	6	04.00-05.06	AYL		EPBMFT5-D005P	90557		

GALAXY II (WA6)

1.6 TDCi	1560	85	4	02.11-06.15	T1WA, T1WB		EPBMWT4-V003D	94395		
1.6 EcoBoost	1596	118	4	11.10-06.15	JTWA, JTWB		EPBMWT4-V003D	94395		
1.8 TDCi	1753	74	4	05.06-06.15	FFWA		EPBMWT4-A001D	95860		
1.8 TDCi	1753	92	4	05.06-06.15	QYWA		EPBMWT4-A001D	95860		
2.0 TDCi	1997	85	4	11.07-06.15	DOHCRTC		EPBMWT4-A001D	95860		
2.0 TDCi	1997	85	4	11.07-06.15	DOHCDSL		EPBMWT4-V003D	94395		
2.0 TDCi	1997	96	4	05.06-06.15	AZWA		EPBMWT4-A001D	95860		
2.0 TDCi	1997	100	4	05.06-06.15	AZWC, UKWA		EPBMWT4-V003D	94395		
2.0 TDCi	1997	103	4	05.06-06.15	Dura- torqCRTCDW10C		EPBMWT4-V003D	94395		
2.0 TDCi	1997	103	4	05.06-06.15	DW		EPBMWT4-A001D	95860		
2.0 TDCi	1997	120	4	03.10-06.15	TXWA		EPBMWT4-V003D	94395		
2.0 EcoBoost	1999	149	4	03.10-06.15	TNWA		EPBMWT4-V003D	94395		
2.2 TDCi	2179	129	4	11.10-12.12	Q4WA		EPBMWT4-A001D	95860		
2.2 TDCi	2179	147	4	11.10-06.15	KNWA		EPBMWT4-V002D	95695		

GRAND C-MAX (DXA/CB7, DXA/CEU)

1.0 EcoBoost	998	74	3	10.12-	M2DA, SFDA		EPBMWT4-V002D	95695		
1.0 EcoBoost	998	92	3	10.12-	B7DA, M1DA, M1DD		EPBMWT4-V002D	95695		
1.6 TDCi	1560	70	4	12.10-	T3DA, T3DB		EPBMWT4-V002D	95695		
1.6 TDCi	1560	85	4	12.10-	T1DA, T1DB		EPBMWT4-V002D	95695		
1.6 Ti	1596	77	4	12.10-04.11	IQDA, IQDB		EPBMWT4-V002D	95695		
1.6 Ti	1596	92	4	12.10-04.11	PNDA		EPBMWT4-V002D	95695		
1.6 EcoBoost	1596	110	4	12.10-	JQDA, JQDB		EPBMWT4-V002D	95695		
1.6 EcoBoost	1596	134	4	12.10-	JTDA, JTDB		EPBMWT4-V002D	95695		
2.0 TDCi	1997	85	4	02.11-	TYDA		EPBMWT4-V002D	95695		
2.0 TDCi	1997	100	4	02.11-	UKDB		EPBMWT4-V002D	95695		
2.0 TDCi	1997	103	4	02.11-	UFDB		EPBMWT4-V002D	95695		
2.0 TDCi	1997	120	4	12.10-	TXDB		EPBMWT4-V002D	95695		

KA (RU8)

1.3 TDCi	1248	55	4	10.08-10.10	BAAA, FD4		EPBMFN4-V017H	96226		
1.3 TDCi	1248	55	4	11.10-	FD4, BAAA		EPBMFT4-V004H	90957		

KUGA I

2.0 TDCi	1997	100	4	03.08-11.12	G6DG, UKDA		EPBMWT4-V002D	95695		
2.0 TDCi 4x4	1997	100	4	03.08-11.12	G6DG, UKDA		EPBMWT4-V002D	95695		
2.0 TDCi	1997	103	4	03.10-11.12	UFDA		EPBMWT4-V002D	95695		
2.0 TDCi 4x4	1997	103	4	03.10-11.12	UFDA		EPBMWT4-V002D	95695		



MAF



l kW
C
Y
I



Type-Nº

Stock-Nº

Plug In
Alternative
Type-Nº

Plug In
Subtype

FORD

KUGA I

2.0 TDCi 4x4	1997	120	4	03.10-11.12	TXDA		EPBMWT4-V002D	95695		
2.5 4x4	2522	147	5	02.08-11.12	HYDB		EPBMFT5-V021H	95278		

KUGA II (DM2) | ESCAPE

1.6 EcoBoost	1596	110	4	03.13-	JQMA, JQMB		EPBMWT4-V002D	95695		
1.6 EcoBoost 4x4	1596	134	4	03.13-	JTMA		EPBMWT4-V002D	95695		
2.0 TDCi	1997	103	4	03.13-	UFMA		EPBMWT4-V002D	95695		
2.0 TDCi 4x4	1998	120	4	03.13-	TXDA, TXMA		EPBMWT4-V002D	95695		

MAVERICK

2.3 16V	2261	110	4	03.04-	GZ		EPBMWN6-A001D	91743		
---------	------	-----	---	--------	----	--	---------------	-------	--	--

MONDEO I (GBP, BNP)

1.6 i 16V	1597	65	4	07.94-08.96	L1J		EPBMWN4-A011H	96418		
1.6 i 16V	1597	66	4	02.93-08.96	L1F		EPBMWN4-A011H	96418		
1.8 i 16V	1796	82	4	01.94-08.96	RKB		EPBMWN4-A011H	96418		
1.8 i 16V	1796	85	4	02.93-08.96	RKA		EPBMWN4-A011H	96418		
1.8 i 16V 4x4	1796	85	4	02.93-08.96	RKA		EPBMWN4-A011H	96418		

MONDEO II (BAP, BFP, BNP)

1.6 i	1597	66	4	08.96-05.98	L1J		EPBMWN4-A011H	96418		
1.6 i	1597	66	4	06.98-09.00	L1J		EPBMFT6-A026H	93281		
1.8 i	1796	85	4	08.96-05.98	RKB, RKF, RKH, RKJ, RKK		EPBMWN4-A011H	96418		
1.8 i	1796	85	4	06.98-09.00	RKB		EPBMFT6-A026H	93281		
2.0 i	1988	96	4	08.96-05.98	NGA, NGB, NGC, NGD		EPBMWN4-A011H	96418		
2.0 i	1988	96	4	06.98-09.00	NGA		EPBMFT6-A026H	93281		

MONDEO III (B5Y, B4Y, BWY)

1.8 16V	1798	81	4	10.00-03.07	CGBA, CGBB		EPBMFT6-A026H	93281		
1.8 16V	1798	92	4	10.00-03.07	CHBA, CHBB		EPBMFT6-A026H	93281		
1.8 SCi	1798	96	4	06.03-03.07	CFBA		EPBMFT5-V033H	95261		
2.0 16V DI / TDDi / TDCi	1998	66	4	03.06-03.07	D5BA		EPBMWN4-A002D	91111		
2.0 16V TDDi / TDCi	1998	85	4	10.00-03.07	HJB		EPBMWN4-A002D	91111		
2.0 DI	1998	92	4	09.03-03.07	PD20FMCR		EPBMWN4-A002D	91111		
2.0 TDCi	1998	96	4	10.01-03.07	FMBA, N7BA		EPBMWN4-A002D	91111		
2.0 16V	1999	107	4	10.00-03.07	CJBA, CJBB		EPBMFT6-A026H	93281		

MONDEO IV (BA7)

1.6 TDCi	1560	85	4	02.11-01.15	T1BA, T1BB, T1BC		EPBMWT4-V003D	94395		
1.6 Ti	1596	81	4	03.07-01.15	RHBA		EPBMWN6-A001D	91743		
1.6 Ti	1596	88	4	07.10-12.14	KGBA		EPBMWN6-A001D	91743		
1.6 Ti	1596	92	4	03.07-01.15	PNBA		EPBMWN6-A001D	91743		
1.6 Ti	1596	92	4	03.07-01.15	PNBA		EPBMWT4-V003D	94395		
1.6 EcoBoost	1596	118	4	02.11-01.15	JTBA, JTBB		EPBMWT4-V003D	94395		
1.8 TDCi	1753	74	4	03.07-01.15	FFBA		EPBMWT4-A001D	95860		
2.0 TDCi	1997	85	4	11.07-01.15	KLBA, LPBA, TYBA		EPBMWT4-A001D	95860		



MAF
 l kW
C
Y
I

Type-N°

Stock-N°

Plug In
Alternative
Type-N°Plug In
Subtype**FORD****MONDEO IV (BA7)**

2.0 TDCi	1997	96	4	03.07-01.15	AZBA		EPBMWT4-A001D	95860		
2.0 TDCi	1997	103	4	03.07-01.15	QXBB, UFBA		EPBMWT4-A001D	95860		
2.0 SCTi	1999	149	4	03.10-01.15	TNBA		EPBMWT4-V003D	94395		
2.0 EcoBoost	1999	176	4	07.10-01.15	TPBA		EPBMWT4-V003D	94395		
2.2 TDCi	2179	129	4	03.08-10.10	Q4BA		EPBMWT4-A001D	95860		
2.2 TDCi	2179	147	4	11.10-01.15	KNBA		EPBMWT4-V002D	95695		
2.5	2521	162	5	03.07-01.15	HUBA		EPBMFT5-V021H	95278		

PUMA (EC_)

1.7 16V	1679	92	4	06.97-12.01	MHA		EPBMWN4-A011H	96418		
Racing ST 160	1679	114	4	08.99-08.01	MHA		EPBMWN4-A011H	96418		

RANGER (ER, EQ, R_)

2.5 TD	2500	62	4	04.02-06.06	WLT		EPBMWT5-A014D	90205		
2.5 TD 4x4	2500	62	4	04.02-06.06	WLT		EPBMWT5-A014D	90205		
2.5 TD 4x4	2500	80	4	10.99-06.06	WLT		EPBMWT5-A014D	90205		

RANGER (ET)

2.5 TDCi 4x4	2499	105	4	05.06-07.12	WLAA		EPBMWT5-A014D	90205		
2.5 TDdi	2499	105	4	05.06-07.12	WLAA		EPBMWT5-A014D	90205		

RANGER (TKE)

2.2 TDCi	2198	88	4	04.11-	GBVAJPF		EPBMWT4-V003D	94395		
2.2 TDCi	2198	92	4	04.11-	GBVAJQW		EPBMWT4-V003D	94395		
2.2 TDCi 4x4	2198	92	4	04.11-	GBVAJQW		EPBMWT4-V003D	94395		
2.2 TDCi	2198	96	4	05.15-	T22DD0P		EPBMWT4-V003D	94395		
2.2 TDCi 4x4	2198	96	4	05.15-	T22DD0P		EPBMWT4-V003D	94395		
2.2 TDCi	2198	110	4	11.11-	GBVAJQJ		EPBMWT4-V003D	94395		
2.2 TDCi 4x4	2198	110	4	04.11-	GBVAJQJ		EPBMWT4-V003D	94395		
2.2 TDCi	2198	118	4	05.15-	T22DD0P		EPBMWT4-V003D	94395		
2.2 TDCi 4x4	2198	118	4	05.15-	GBVAJQJ		EPBMWT4-V003D	94395		
3.2 TDCi 4x4	3198	147	5	04.11-	ENSA, SA2R, SA2S, SA2W, SAFA		EPBMWT4-V003D	94395		

SCORPIO II (GFR, GGR, GNR, GGR)

2.0 i	1998	85	4	10.94-08.98	NSD		EPBMWN4-A011H	96418		
2.0 i 16V	1998	100	4	10.94-08.98	N3A		EPBMWN4-A011H	96418		
2.3 i 16V	2295	108	4	06.96-08.98	Y5A		EPBMWN4-A011H	96418		

S-MAX (WA6)

1.6 TDCi	1560	85	4	02.11-12.14	T1WA, T1WB		EPBMWT4-V003D	94395		
1.6 EcoBoost	1596	118	4	02.11-12.14	JTWA, JTWB		EPBMWT4-V003D	94395		
1.8 TDCi	1753	92	4	05.06-12.14	QYWA		EPBMWT4-A001D	95860		
2.0 TDCi	1997	85	4	11.07-12.14	DOHCRTC		EPBMWT4-A001D	95860		
2.0 TDCi	1997	85	4	11.07-12.14	DOHCDSL		EPBMWT4-V003D	94395		
2.0 TDCi	1997	96	4	05.06-12.14	AZWA		EPBMWT4-A001D	95860		



MAF



l kW
C
Y
I



Type-Nº

Stock-Nº

Plug In
Alternative
Type-Nº

Plug In
Subtype

FORD

S-MAX (WA6)

2.0 TDCi	1997	100	4	05.06-12.14	AZWC, UKWA		EPBMWT4-V003D	94395		
2.0 TDCi	1997	103	4	05.06-12.14	Dura-torqCRTCDW10C		EPBMWT4-V003D	94395		
2.0 TDCi	1997	103	4	05.06-12.14	DW		EPBMWT4-A001D	95860		
2.0 TDCi	1997	120	4	03.10-12.14	TXWA		EPBMWT4-V003D	94395		
2.0 EcoBoost	1999	149	4	03.10-12.14	TNWA		EPBMWT4-V003D	94395		
2.0 EcoBoost	1999	176	4	07.10-12.14	TPWA		EPBMWT4-V003D	94395		
2.2 TDCi	2179	147	4	11.10-12.14	KNWA		EPBMWT4-V002D	95695		
2.5 ST	2521	162	5	05.06-12.14	HUWA		EPBMFT5-V021H	95278		

TOURNEO CONNECT

1.8 TDCi /TDDi /DI	1753	55	4	08.06-12.13	BHPA		EPBMWT4-A001D	95860		
1.8 TDCi	1753	66	4	08.06-12.13	HCPB, HCPA		EPBMWT4-A001D	95860		
1.8 TDCi	1753	81	4	08.06-12.13	RWPA		EPBMWT4-A001D	95860		

TOURNEO CONNECT / GRAND TOURNEO CONNECT V408 MPV

1.0 EcoBoost	998	74	3	11.13-	B3GA, M2GA, M2GB		EPBMWT4-V003D	94395		
1.6 TDCi	1560	55	4	09.13-	UBGA		EPBMWT4-V002D	95695		
1.6 TDCi	1560	70	4	09.13-	TZGA, TZGB		EPBMWT4-V002D	95695		
1.6 TDCi	1560	85	4	09.13-	T1GA		EPBMWT4-V002D	95695		

TOURNEO CUSTOM V362 (F3)

2.0 EcoBlue	1995	77	4	12.15-	BJFA, BJFB, YLF6, YLFA, YLFB, YLFS		EPBMWT4-V003D	94395		
2.0 EcoBlue	1995	96	4	12.15-	BKFA, BKFB, YMF6, YMFA, YMFB, YMFS		EPBMWT4-V003D	94395		
2.0 EcoBlue	1995	125	4	12.15-	BLFA, BLFB, YNF6, YNFA, YNFB, YNFS		EPBMWT4-V003D	94395		
2.2 TDCi	2198	92	4	04.12-	CYF4, CYFF		EPBMWT4-V003D	94395		
2.2 TDCi	2198	114	4	04.12-	CVFF		EPBMWT4-V003D	94395		

TRANSIT (FA __, FM __, FN __, FF __, FD __, FB __, FS __, FZ __, FC __)

2.0 DI	1998	55	4	08.00-05.06	D3FA		EPBMWN4-A002D	91111		
2.0 DI	1998	63	4	08.00-05.06	F3FA		EPBMWN4-A002D	91111		
2.0 DI	1998	74	4	08.00-05.06	ABFA		EPBMWN4-A002D	91111		
2.0 TDCi	1998	92	4	08.02-05.06	FIFA		EPBMWN4-A002D	91111		
2.2 TDCi	2198	63	4	04.06-08.14	P8FB, P8FA		EPBMWT4-A001D	95860		
2.2 TDCi	2198	74	4	10.11-08.14	DRFA, DRFB, DRFC, DRFD, DRFE		EPBMWT4-V003D	94395		
2.2 TDCi RWD	2198	74	4	10.11-08.14	DRRA, DRRB, DRRC		EPBMWT4-V003D	94395		
2.2 TDCi	2198	81	4	04.06-08.14	QVFA		EPBMWT4-A001D	95860		
2.2 TDCi	2198	85	4	10.08-08.14	SRFA, SRFB, SRFC, SRFD, SRFE		EPBMWT4-V003D	94395		
2.2 TDCi	2198	92	4	10.11-08.14	CYFA, CYFB, CYFC, CYFD		EPBMWT4-V003D	94395		
2.2 TDCi 4x4	2198	92	4	10.11-08.14	CYRB, CYRC		EPBMWT4-V003D	94395		
2.2 TDCi RWD	2198	92	4	09.11-12.14	CYRA, CYRB		EPBMWT4-V003D	94395		
2.2 TDCi	2198	96	4	04.06-08.14	QWFA		EPBMWT4-A001D	95860		
2.2 TDCi RWD	2198	100	4	09.11-08.14	USRA, USRB		EPBMWT4-V003D	94395		
2.2 TDCi	2198	103	4	10.07-08.14	22ICRTC4DSL		EPBMWT4-V003D	94395		



MAF



l kW
C
Y
I



Type-N°

Stock-N°

Plug In
Alternative
Type-N°

Plug In
Subtype

FORD

TRANSIT (FA __, FM __, FN __, FF __, FD __, FB __, FS __, FZ __, FC __)

2.2 TDCi	2198	103	4	10.07-08.14	Puma		EPBMWT4-A001D	95860		
2.2 TDCi RWD	2198	114	4	10.11-08.14	CVRA, CVRB, CVRC		EPBMWT4-V003D	94395		
2.4 TDCi	2402	74	4	04.06-08.14	PHFC, PHFA		EPBMWT4-A001D	95860		
2.4 TDCi RWD	2402	74	4	04.06-08.14	PHFA, PHFC		EPBMWT4-A001D	95860		
2.4 TDE	2402	85	4	03.04-05.06	FXFA		EPBMWN4-A002D	91111		
2.4 TDCi	2402	85	4	04.06-08.14	JXFA		EPBMWT4-A001D	95860		
2.4 TDCi RWD	2402	85	4	04.06-08.14	JXFA		EPBMWT4-A001D	95860		
2.4 TDE	2402	92	4	07.01-05.06	DOFA		EPBMWN4-A002D	91111		
2.4 TDCi	2402	101	4	03.04-05.06	H9FA		EPBMWN4-A002D	91111		
2.4 TDCi 4x4	2402	103	4	11.06-08.14	H9FB		EPBMWT4-A001D	95860		
3.2 TDCi RWD	3199	147	5	09.07-08.14	SAFA, SAFB		EPBMWT4-V003D	94395		
3.2 TDCi RWD	3199	147	5	09.07-08.14	SAFA		EPBMWT4-A001D	95860		
3.2 TDCi	3199	147	5	02.08-08.14	SAFA, SAFB		EPBMWT4-V003D	94395		
3.2 TDCi	3199	147	5	02.08-08.14	SAFA		EPBMWT4-A001D	95860		

TRANSIT CONNECT (P65 __, P70 __, P80 __)

1.8 Di	1753	55	4	06.02-12.13	BHPA, P7PA, P7PB, R2PA	; 93EEC; Euro4	EPBMWT4-A001D	95860		
1.8 Di	1753	55	4	06.02-12.13	BHPA, P7PA, P7PB, R2PA	; Euro5	EPBMWT4-V003D	94395		
1.8 TDCi	1753	66	4	06.02-12.13	HCPA, HCPB, HCPC, HCPD, P9PA, P9PB, P9PC, P9PD, R3PA, RWPE, RWPF	; 93EEC; Euro4	EPBMWT4-A001D	95860		
1.8 TDCi	1753	66	4	06.02-12.13	HCPA, HCPB, HCPC, HCPD, P9PA, P9PB, P9PC, P9PD, R3PA, RWPE, RWPF	; Euro5	EPBMWT4-V003D	94395		
1.8 TDCi	1753	81	4	08.06-12.13	RWPA, RWPB, RWPC, RWPD	; 93EEC; Euro4	EPBMWT4-A001D	95860		
1.8 TDCi	1753	81	4	08.06-12.13	RWPA, RWPB, RWPC, RWPD	; Euro5	EPBMWT4-V003D	94395		
1.8 16V	1796	85	4	06.02-12.13	EYPA, EYPC, EYPD		EPBMFT6-A026H	93281		
1.8 16V LPG	1796	85	4	06.02-12.13	EYPC		EPBMFT6-A026H	93281		

TRANSIT CONNECT MPV

1.6 TDCi	1560	55	4	02.13-	UBGA		EPBMWT4-V002D	95695		
1.6 TDCi	1560	70	4	02.13-	TZGA, TZGB		EPBMWT4-V002D	95695		
1.6 TDCi	1560	85	4	02.13-	T1GA		EPBMWT4-V002D	95695		

TRANSIT CONNECT V408 BOX BODY/MPV

1.0 EcoBoost	998	74	3	02.13-	B3GA, M2GA, M2GB		EPBMWT4-V003D	94395		
1.6 TDCi	1560	55	4	02.13-	UBGA		EPBMWT4-V002D	95695		
1.6 TDCi	1560	70	4	02.13-	TZGA, TZGB		EPBMWT4-V002D	95695		
1.6 TDCi	1560	85	4	02.13-	T1GA		EPBMWT4-V002D	95695		

TRANSIT CUSTOM V362 (F3, FY, FZ)

2.0 EcoBlue	1995	77	4	12.15-	BJFA, BJFB, YLF6, YLFA, YLFB, YLFS		EPBMWT4-V003D	94395		
2.0 EcoBlue	1995	96	4	12.15-	BKFA, BKFB, YMF6, YMFA, YMFB, YMFS		EPBMWT4-V003D	94395		
2.0 EcoBlue	1995	125	4	12.15-	BLFA, BLFB, YNF6, YNFA, YNFB, YNFS		EPBMWT4-V003D	94395		



MAF



l kW
C
Y
I



Type-Nº

Stock-Nº

Plug In
Alternative
Type-Nº

Plug In
Subtype

FORD

TRANSIT CUSTOM V362 (F3, FY, FZ)

2.2 TDCi	2198	74	4	04.12-	DRF4, DRFF, DRFG		EPBMWT4-V003D	94395		
2.2 TDCi	2198	92	4	04.12-	CYF4, CYFF		EPBMWT4-V003D	94395		
2.2 TDCi	2198	114	4	04.12-	CVFF		EPBMWT4-V003D	94395		

TRANSIT TOURNEO BUS

2.0	1998	84	4	11.94-12.00	NSH		EPBMWN4-A011H	96418		
2.2 TDCi	2198	81	4	07.06-08.14	QVFA		EPBMWT4-A001D	95860		
2.2 TDCi	2198	96	4	07.06-08.14	QWFA		EPBMWT4-A001D	95860		
2.2 TDCi	2198	103	4	10.07-08.14	PGFA		EPBMWT4-A001D	95860		

TRANSIT V363 (FAD, FBD, FED, FFD, FCD, FDD)

2.0 EcoBlue	1995	77	4	03.16-	BJFA, BJFB, YLF6, YLFA, YLFB, YLFS		EPBMWT4-V003D	94395		
2.0 EcoBlue	1995	96	4	03.16-	BKFA, BKFB, YMF6, YMFA, YMFB, YMFS		EPBMWT4-V003D	94395		
2.0 EcoBlue	1995	125	4	03.16-	BLFA, BLFB, YNF6, YNFA, YNFB, YNFS		EPBMWT4-V003D	94395		

FORD USA

MUSTANG COUPE

5.0 V8	4951	308	8	01.15-	MF8F		EPBMWT4-V003D	94395		
5.0 V8	4951	310	8	07.15-	MF8F		EPBMWT4-V003D	94395		

GAZ

GAZELLE BOX

2.3	2287	81	4	01.94-12.02	ZMZ406110		EPBMFT5-V039H	90466		
-----	------	----	---	-------------	-----------	--	---------------	-------	--	--

SOBOL (2217) BUS

2.3	2287	81	4	09.97-04.13	ZMZ406210		EPBMFT5-V039H	90466		
2.5 i	2464	112	4	09.01-04.13	ZMZ4052210		EPBMFT5-V039H	90466		

SOBOL (2310)

2.3	2287	81	4	09.97-04.13	ZMZ406110		EPBMFT5-V039H	90466		
2.5 i	2464	112	4	09.01-04.13	ZMZ4052210		EPBMFT5-V039H	90466		

SOBOL (2752) BOX

2.3	2287	81	4	09.97-04.13	ZMZ406110		EPBMFT5-V039H	90466		
2.5 i	2464	112	4	09.97-04.13	ZMZ4052210		EPBMFT5-V039H	90466		

HONDA

ACCORD V (CE, CF_, CD)

2.0 TDi	1994	77	4	04.96-10.98	20T2N		EPBMFT5-V031H	97525		
---------	------	----	---	-------------	-------	--	---------------	-------	--	--

ACCORD VI (CK, CG, CH, CF, CL)

2.0 TDi	1994	77	4	12.99-10.00	20T2N		EPBMFT5-V031H	97525		
2.0 Turbo DI	1994	77	4	02.99-12.02	20T2N		EPBMFT5-V031H	97525		

ACCORD VIII (CU, CW)

2.2 i-DTEC	2199	110	4	07.08-	N22B1		EPBMWN5-V004D	94183		
2.2 i-DTEC	2199	132	4	07.08-	N22B2		EPBMWN5-V004D	94183		

CIVIC IX (FK)

1.6 i-DTEC	1597	88	4	01.14-	N16A1		EPBMWN5-V004D	94183		
2.2 i-DTEC	2199	110	4	02.12-	N22B4		EPBMWN5-V004D	94183		



MAF



l kW
C
Y
I



Type-N°

Stock-N°

Plug In
Alternative
Type-N°

Plug In
Stock-N°

HONDA

CIVIC VII HATCHBACK (EU, EP, EV)

1.7 CTDi	1686	74	4	01.02-09.05	4EE-2		EPBMFT5-V039H	90466	EPBMFT5-V001P	93006
----------	------	----	---	-------------	-------	--	---------------	-------	---------------	-------

CIVIC VIII HATCHBACK (FN, FK)

2.2 CTDi	2204	103	4	09.05-	N22A2		EPBMWN5-V004D	94183		
----------	------	-----	---	--------	-------	--	---------------	-------	--	--

CR-V II (RD_)

2.2 CTDi	2204	103	4	02.05-09.06	N22A2		EPBMWN5-V004D	94183		
----------	------	-----	---	-------------	-------	--	---------------	-------	--	--

CR-V III (RE_)

2.2 i-DTEC 4WD	2199	110	4	01.07-	N22B3		EPBMWN5-V004D	94183		
2.2 i-CTDi 4WD	2204	103	4	01.07-	N22A2		EPBMWN5-V004D	94183		

CR-V IV (RM_)

1.6 i-DTEC	1597	88	4	10.13-	N16A1		EPBMWN5-V004D	94183		
1.6 i-DTEC 4WD	1597	118	4	02.15-	N16A4		EPBMWN5-V004D	94183		
2.2 i-DTEC AWD	2199	110	4	10.12-	N22B4		EPBMWN5-V004D	94183		

HUMMER

HUMMER H3

3.5	3460	162	5	04.05-	L52		EPBMWT5-V023H	95103		
-----	------	-----	---	--------	-----	--	---------------	-------	--	--

HYUNDAI

ACCENT II (LC)

1.3	1341	55	4	01.00-11.05	G4EA		EPBMFT5-V013H	96559		
1.3	1341	61	4	01.00-11.05	G4EA		EPBMFT5-V013H	96559		
1.3	1341	62	4	08.02-11.05	G4EH		EPBMFT5-V013H	96559		
1.3	1341	63	4	01.00-11.05	G4EA		EPBMFT5-V013H	96559		
1.5 CRDi	1493	60	3	01.02-11.05	D3EA		EPBMFT5-V029H	90502	EPBMFT5-V001P	93006
1.5	1495	65	4	09.99-10.02	G4EK		EPBMFT5-V013H	96559		
1.5	1495	66	4	01.00-11.05	G4EB		EPBMFT5-V013H	96559		
1.5	1495	68	4	01.00-10.02	G4EK		EPBMFT5-V013H	96559		
1.5	1495	69	4	01.00-12.06	G4EK		EPBMFT5-V013H	96559		
1.5	1495	73	4	09.99-10.02	G4FK		EPBMFT5-V013H	96559		
1.5	1495	75	4	09.00-11.05	G4EC-G		EPBMFT5-V013H	96559		
1.5	1495	77	4	09.99-10.02	G4FK		EPBMFT5-V013H	96559		

ACCENT III (MC)

1.5 CRDi GLS	1493	81	4	11.05-11.10	D4FA		EPBMFT5-V005H	93645		
1.6 GLS	1599	82	4	01.06-12.06	G4ED		EPBMWT5-D012H	91007		

ACCENT IV SALOON (RB) | ACCENT I25 | SOLARIS | I25 ACCENT

1.6 CRDI	1582	100	4	04.11-	D4FB		EPBMFT5-V005H	93645		
----------	------	-----	---	--------	------	--	---------------	-------	--	--

COUPE (GK) | TUSCANI

2.0	1975	100	4	09.02-12.04	G4GC-G		EPBMWT5-D012H	91007		
2.0	1975	102	4	09.02-09.06	G4GC-G		EPBMWT5-D012H	91007		
2.0 GLS	1975	105	4	02.03-12.06	G4GC-G		EPBMWT5-D012H	91007		
2.7 V6	2656	121	6	01.01-10.08	G6BA-G		EPBMWN3-A017H	95114		



MAF



l kW
C
y
I



Type-Nº

Stock-Nº

Plug In
Alternative
Type-Nº

Plug In
Subtype

HYUNDAI

COUPE (GK) | TUSCANI

2.7 V6	2656	123	6	03.02-10.08	G6BA-G		EPBMWN3-A017H	95114		
--------	------	-----	---	-------------	--------	--	---------------	-------	--	--

COUPE (RD)

2.0 16V	1975	99	4	03.01-04.02	G4DF		EPBMWT5-D012H	91007		
2.0 16V	1975	102	4	08.96-04.02	G4GF		EPBMWT5-D012H	91007		

ELANTRA (XD) | AVANTE

2.0	1975	104	4	06.03-03.04	G4GC		EPBMWT5-D012H	91007		
2.0 CRDi	1991	83	4	04.01-07.06	D4EA		EPBMFT5-V017H	90311		

ELANTRA SALOON (MD, UD) | I35 | AVANTE

1.6 CRDi	1582	94	4	02.11-12.15	D4FB		EPBMFT5-V005H	93645		
1.6 CRDi	1582	100	4	10.15-	D4FB		EPBMFT5-V005H	93645		

GETZ (TB)

1.5 CRDi	1493	60	3	03.03-08.05	D3EA		EPBMFT5-V029H	90502	EPBMFT5-V001P	93006
1.5 CRDi	1493	60	3	08.05-09.05	D3EA		EPBMFT5-V005H	93645		
1.5 CRDi	1493	65	4	08.05-06.09	D4FA		EPBMFT5-V005H	93645		
1.5 CRDi GLS	1493	81	4	08.05-06.09	D4FA		EPBMFT5-V005H	93645		

GRANDEUR (TG) | AZERA

2.2 CRDi	2188	110	4	06.06-12.11	D4EB		EPBMFT5-V002H	97685		
2.2 CRDi	2188	114	4	06.06-10.10	D4EB		EPBMFT5-V002H	97685		

H-1 (A1)

2.4	2351	82	4	03.00-04.04	G4CS		EPBMFT5-V017H	90311		
2.4 4WD	2351	99	4	06.01-04.04	G4JS		EPBMFT5-V017H	90311		
2.4	2351	101	4	02.03-04.04	G4JS		EPBMFT5-V017H	90311		
2.4	2351	107	4	11.01-04.04	G4JS		EPBMFT5-V017H	90311		
2.5 CRDi	2497	81	4	06.06-12.06	D4CB		EPBMFT5-V030H	96975	EPBMFT5-V001P	93006
2.5 CRDi	2497	81	4	06.06-12.07	D4CB	; Euro4	EPBMFT5-V002H	97685		
2.5 CRDi	2497	103	4	12.02-12.07	D4CB		EPBMFT5-V030H	96975	EPBMFT5-V001P	93006
2.5 CRDi 4WD	2497	103	4	12.02-04.04	D4CB		EPBMFT5-V030H	96975	EPBMFT5-V001P	93006
2.5 CRDi 4WD	2497	103	4	12.02-04.04	D4CB		EPBMFT5-V002H	97685	EPBMFT5-V001P	93006
2.5 CRDi	2497	103	4	08.03-12.07	D4CB	; Euro4	EPBMFT5-V002H	97685		
2.5 CRDi	2497	120	4	12.02-04.04	D4CB	; Euro4	EPBMFT5-V002H	97685		

H-1 (TQ)

2.5 CRDi	2497	81	4	02.08-	D4CB		EPBMFT5-V002H	97685		
2.5 CRDi	2497	85	4	01.09-	D4CB		EPBMFT5-V002H	97685		
2.5 CRDi	2497	94	4	01.09-	D4CB		EPBMFT5-V002H	97685		
2.5 CRDi	2497	100	4	07.08-	D4CB, D4CB-W		EPBMFT5-V002H	97685		
2.5 CRDi	2497	120	4	02.08-	D4CB, D4CBL		EPBMFT5-V002H	97685		
2.5 CRDi	2497	125	4	02.08-	D4CB		EPBMFT5-V002H	97685		

H100 (HR) | H-100 BAKKIE

2.5 TD	2477	74	4	11.06-	4D56T		EPBMFT5-V030H	96975		
--------	------	----	---	--------	-------	--	---------------	-------	--	--



MAF



l kW
C
Y
I



Type-Nº

Stock-Nº

Plug In
Alternative
Type-Nº

Plug In
Sleeve

HYUNDAI

H100 (HR) | H-100 BAKKIE

2.5 TD	2477	74	4	11.06-	4D56T		EPBMFT5-V002H	97685		
2.5 CRDi	2497	96	4	01.04-	D4CB		EPBMFT5-V002H	97685		

H350

2.5 CRDi	2497	110	4	04.15-	D4CB		EPBMFT5-V002H	97685		
2.5 CRDi	2497	125	4	04.15-	D4CB		EPBMFT5-V002H	97685		

I10 (PA)

1.1 CRDi	1120	55	3	01.08-12.11	D3FA		EPBMFT5-V005H	93645		
----------	------	----	---	-------------	------	--	---------------	-------	--	--

I20 (GB, IB)

1.1 CRDi	1120	55	3	05.15-	D3FA		EPBMFT5-V005H	93645		
1.4 CRDi	1396	66	4	05.15-	D4FC		EPBMFT5-V005H	93645		

I20 (PB, PBT)

1.1 CRDi	1120	55	3	03.12-12.15	D3FA		EPBMFT5-V005H	93645		
1.4 CRDi	1396	55	4	09.08-12.12	D4FC		EPBMFT5-V005H	93645		
1.4 CRDi	1396	66	4	08.08-12.15	D4FC		EPBMFT5-V005H	93645		
1.6 CRDi	1582	85	4	09.08-12.12	D4FB		EPBMFT5-V005H	93645		
1.6 CRDi	1582	94	4	01.09-12.12	D4FB		EPBMFT5-V005H	93645		

I30 (FD)

1.6 CRDi	1582	66	4	02.08-06.12	D4FB		EPBMFT5-V005H	93645		
1.6 CRDi	1582	85	4	02.08-06.12	D4FB		EPBMFT5-V005H	93645		
1.6 CRDi	1582	94	4	01.10-06.12	D4FB		EPBMFT5-V005H	93645		

I30 (GD)

1.4 CRDi	1396	66	4	06.12-	D4FC		EPBMFT5-V005H	93645		
1.6 CRDi	1582	81	4	06.12-	D4FB		EPBMFT5-V005H	93645		
1.6 CRDi	1582	94	4	06.12-12.15	D4FB, D4FB-5P		EPBMFT5-V005H	93645		
1.6 CRDi	1582	100	4	01.15-	D4FB		EPBMFT5-V005H	93645		

I30 (PDE, PD, PDEN)

1.6 CRDi	1582	70	4	11.16-	D4FB		EPBMFT5-V005H	93645		
1.6 CRDi	1582	81	4	03.17-	D4FB		EPBMFT5-V005H	93645		
1.6 CRDi VGT	1582	81	4	03.17-	D4FB		EPBMFT5-V005H	93645		
1.6 CRDi	1582	94	4	08.18-	D4FB		EPBMFT5-V005H	93645		
1.6 CRDi	1582	100	4	03.17-	D4FB		EPBMFT5-V005H	93645		
1.6 CRDi VGT	1582	100	4	03.17-	D4FB		EPBMFT5-V005H	93645		
1.6 CRDi	1598	70	4	08.18-	D4FE		EPBMFT5-V005H	93645		
1.6 CRDi	1598	85	4	08.18-	D4FE		EPBMFT5-V005H	93645		
1.6 CRDi	1598	100	4	08.18-	D4FE		EPBMFT5-V005H	93645		

I30 COUPE

1.4 CRDi	1396	66	4	05.13-	D4FC		EPBMFT5-V005H	93645		
1.6 CRDi	1582	81	4	11.15-	D4FB		EPBMFT5-V005H	93645		
1.6 CRDi	1582	94	4	05.13-	D4FB		EPBMFT5-V005H	93645		



MAF



ℓ kW C y I



Type-Nº

Stock-Nº

Plug In Alternative Type-Nº

Plug In Subtype

HYUNDAI

I30 COUPE

1.6 CRDi	1582	100	4	12.14-	D4FB		EPBMFT5-V005H	93645		
----------	------	-----	---	--------	------	--	---------------	-------	--	--

I40 (VF)

1.6 CRDi	1598	85	4	07.18-	D4FE		EPBMFT5-V005H	93645		
1.6 CRDi	1598	100	4	07.18-	D4FE		EPBMFT5-V005H	93645		
1.7 CRDi	1685	85	4	03.12-	D4FD		EPBMFT5-V005H	93645		
1.7 CRDi	1685	100	4	03.12-	D4FD		EPBMFT5-V005H	93645		
1.7 CRDi	1685	104	4	01.15-	D4FD		EPBMFT5-V005H	93645		

IX20 (JC)

1.4 CRDi	1396	57	4	06.11-	D4FC-M		EPBMFT5-V005H	93645		
1.4 CRDi	1396	66	4	11.10-	D4FC		EPBMFT5-V005H	93645		
1.6 CRDi	1582	85	4	06.11-	D4FB		EPBMFT5-V005H	93645		
1.6 CRDi	1582	94	4	06.11-	D4FB		EPBMFT5-V005H	93645		

IX35 (LM, EL, ELH) | TUCSON

1.7 CRDi	1685	85	4	11.10-	D4FD		EPBMFT5-V005H	93645		
----------	------	----	---	--------	------	--	---------------	-------	--	--

KONA (OS, OSE, OSI) | KAUI

1.6 CRDi	1598	85	4	08.18-	D4FE		EPBMFT5-V005H	93645		
1.6 CRDi e-VGT	1598	100	4	08.18-	D4FE		EPBMFT5-V005H	93645		
1.6 CRDi e-VGT AWD	1598	100	4	08.18-	D4FE		EPBMFT5-V005H	93645		

LANTRA II (J-2)

2.0 16V	1975	102	4	08.96-09.00	G4GF		EPBMWT5-D012H	91007		
---------	------	-----	---	-------------	------	--	---------------	-------	--	--

MATRIX (FC) | LAVITA

1.5 CRDi	1493	60	3	10.01-12.05	D3EA		EPBMFT5-V029H	90502	EPBMFT5-V001P	93006
1.5 CRDi	1493	60	3	10.01-08.10	D3EA	; Euro3	EPBMFT5-V053H	95935		
1.5 CRDi	1493	60	3	10.01-08.10	D3EA	; Euro4	EPBMFT5-V005H	93645		
1.5 CRDi	1493	75	4	06.05-08.10	D4FA	; Euro3	EPBMFT5-V053H	95935		
1.5 CRDi	1493	75	4	06.05-08.10	D4FA	; Euro4	EPBMFT5-V005H	93645		
1.5 CRDi VGT	1493	81	4	08.05-08.10	D4FA		EPBMFT5-V005H	93645		

PORTER VAN

2.5 CRDi	2497	103	4	02.03-04.04	D4CB		EPBMFT5-V030H	96975		
----------	------	-----	---	-------------	------	--	---------------	-------	--	--

SANTA FÉ I (SM)

2.0 CRDi	1991	83	4	08.01-12.05	D4EA		EPBMFT5-V010H	96310		
2.0 CRDi 4x4	1991	83	4	04.01-12.05	D4EA		EPBMFT5-V010H	96310		
2.0 CRDi	1991	83	4	10.04-	D4EA		EPBMFT5-V017H	90311		
2.0 CRDi 4x4	1991	83	4	10.04-	D4EA		EPBMFT5-V017H	90311		
2.4 16V	2351	100	4	02.01-03.06	G4JS-G		EPBMFT5-V017H	90311		
2.4 16V 4x4	2351	100	4	02.01-03.06	G4JS-G		EPBMFT5-V017H	90311		
2.4 16V	2351	107	4	02.01-03.06	G4JS-G		EPBMFT5-V017H	90311		
2.4 16V 4x4	2351	107	4	02.01-03.06	G4JS-G		EPBMFT5-V017H	90311		
2.7 V6 4x4	2656	127	6	03.01-10.01	G6BA-G		EPBMWN3-A017H	95114		



MAF



l kW
C
Y
I



Type-Nº

Stock-Nº

Plug In
Alternative
Type-Nº

Plug In
Subtype

HYUNDAI

SANTA FÉ I (SM)

2.7	2656	129	6	08.04-03.06	G6EA		EPBMWN3-A017H	95114		
-----	------	-----	---	-------------	------	--	---------------	-------	--	--

SANTA FÉ II (CM)

2.2 CRDi	2188	102	4	03.06-12.12	D4EB		EPBMFT5-V002H	97685		
2.2 CRDi 4x4	2188	102	4	03.06-12.12	D4EB		EPBMFT5-V002H	97685		
2.2 CRDi GLS	2188	110	4	03.06-12.09	D4EB		EPBMFT5-V002H	97685		
2.2 CRDi GLS 4x4	2188	110	4	03.06-12.09	D4EB		EPBMFT5-V002H	97685		
2.2 CRDi	2188	114	4	03.06-12.09	D4EB		EPBMFT5-V002H	97685		
2.2 CRDi 4x4	2188	114	4	03.06-12.09	D4EB		EPBMFT5-V002H	97685		
2.2 CRDi	2199	145	4	01.09-12.12	D4HB		EPBMFT5-V002H	97685		
2.2 CRDi 4x4	2199	145	4	01.09-12.12	D4HB		EPBMFT5-V002H	97685		
2.7 V6 GLS	2656	139	6	03.06-12.09	G6EA		EPBMWN3-A017H	95114		
2.7 V6 GLS 4x4	2656	139	6	03.06-12.09	G6EA		EPBMWN3-A017H	95114		
2.7	2657	125	6	03.06-12.12	G6BA		EPBMWN3-A017H	95114		
2.7 4x4	2657	125	6	03.06-12.12	G6BA		EPBMWN3-A017H	95114		

SONATA IV (EF) | SONICA

2.5 V6 24V	2493	118	6	05.00-10.01	G6BV-G		EPBMWN3-A017H	95114		
2.7 V6	2656	127	6	10.01-11.04	G6BA-G		EPBMWN3-A017H	95114		
2.7 V6	2656	129	6	11.02-11.04	G6BA		EPBMWN3-A017H	95114		

TERRACAN (HP)

2.9 CRDi	2902	110	4	11.01-07.03	J3		EPBMFT5-V030H	96975		
2.9 CRDi 4WD	2902	110	4	12.01-10.06	J3		EPBMFT5-V030H	96975		
2.9 CRDi 4WD	2902	120	4	11.03-12.06	J3		EPBMFT5-V030H	96975	EPBMFT5-V001P	93006

TRAJET (FO)

2.0	1975	103	4	07.04-08.06	G4GC-G		EPBMWT5-D012H	91007		
2.0	1975	104	4	07.04-08.06	G4GC		EPBMWT5-D012H	91007		
2.0 CRDi	1991	83	4	04.01-07.08	D4EA		EPBMFT5-V017H	90311		
2.0 CRDi	1991	92	4	08.05-07.08	D4EA-V		EPBMFT5-V017H	90311		
2.0	1997	100	4	07.00-08.04	G4JP-G		EPBMFT5-V017H	90311		
2.7 V6	2656	127	6	01.01-03.04	G6BA-G		EPBMWN3-A017H	95114		

TUCSON (JM)

2.0	1975	104	4	08.04-06.08	G4GC		EPBMWT5-D012H	91007		
2.0 Allrad	1975	104	4	08.04-06.08	G4GC		EPBMWT5-D012H	91007		
2.0	1975	104	4	09.05-	G4GC		EPBMFT5-V002H	97685		
2.0 CRDi	1991	83	4	08.04-12.06	D4EA		EPBMFT5-V010H	96310		
2.0 CRDi Allrad	1991	83	4	08.04-12.06	D4EA		EPBMFT5-V010H	96310		
2.0 CRDi	1991	100	4	10.06-02.10	D4EA-F		EPBMFT5-V010H	96310		
2.0 CRDi Allrad	1991	100	4	01.06-03.10	D4EA-F		EPBMFT5-V010H	96310		
2.0 CRDi	1991	103	4	01.06-03.10	D4EA-F		EPBMFT5-V010H	96310		
2.0 CRDi Allrad	1991	103	4	01.06-03.10	D4EA-F		EPBMFT5-V010H	96310		
2.0 CRDi All-wheel Drive	1991	103	4	01.06-03.10	D4EA-F	Engine Model:VGT	EPBMFT5-V002H	97685		



MAF



l kW
C
Y
I



Type-Nº

Stock-Nº

Plug In
Alternative
Type-Nº

Plug In
Subtype

HYUNDAI

TUCSON (JM)

2.0 CRDi	1991	110	4	01.09-03.10	D4EA-F		EPBMFT5-V010H	96310		
2.0 CRDi Allrad	1991	110	4	01.09-03.10	D4EA-F		EPBMFT5-V010H	96310		
2.7 Allrad	2656	129	6	08.04-11.10	G6BA-G		EPBMWN3-A017H	95114		

TUCSON (TL, TLE)

1.6 CRDi	1598	85	4	08.18-	D4FE		EPBMFT5-V005H	93645		
1.6 CRDi All-wheel Drive	1598	85	4	08.18-	D4FE		EPBMFT5-V005H	93645		
1.6 CRDi hybrid 48V	1598	85	4	03.19-	D4FE		EPBMFT5-V005H	93645		
1.6 CRDi	1598	100	4	08.18-	D4FE		EPBMFT5-V005H	93645		
1.6 CRDi All-wheel Drive	1598	100	4	08.18-	D4FE		EPBMFT5-V005H	93645		
1.6 CRDi hybrid 48V	1598	100	4	03.19-	D4FE		EPBMFT5-V005H	93645		
1.6 CRDi hybrid 48V All-wheel Drive	1598	100	4	03.19-	D4FE		EPBMFT5-V005H	93645		
1.7 CRDi	1685	85	4	06.15-	D4FD		EPBMFT5-V005H	93645		
1.7 CRDi	1685	104	4	06.15-	D4FD		EPBMFT5-V005H	93645		

XG (XG)

250	2493	120	6	12.98-12.05	G6BV		EPBMWN3-A017H	95114		
30	2972	138	6	12.98-12.05	G6CT-G		EPBMFT5-V001P	93006		
350	3497	145	6	10.02-12.05	G6CU		EPBMFT5-V001P	93006		

INFINITI

EX

37	3694	228	6	10.08-	VQ37VHR		EPBMFN5-V005D	90496		
37	3696	235	6	09.10-	VQ37VHR		EPBMFN5-V005D	90496		

G CONVERTIBLE

37	3696	235	6	09.10-	VQ37VHR		EPBMFN5-V005D	90496		
----	------	-----	---	--------	---------	--	---------------	-------	--	--

G COUPE

37	3696	235	6	09.10-	VQ37VHR		EPBMFN5-V005D	90496		
37	3696	245	6	09.08-12.12	VQ37VHR		EPBMFN5-V005D	90496		

G SALOON

37	3696	235	6	10.08-	VQ37VHR		EPBMFN5-V005D	90496		
37 X	3696	235	6	10.08-	VQ37VHR		EPBMFN5-V005D	90496		
37 X	3696	245	6	09.08-12.13	VQ37VHR		EPBMFN5-V005D	90496		

M (Y51)

37	3696	235	6	03.10-	VQ37VHR		EPBMFN5-V005D	90496		
37 X	3696	246	6	09.10-	VQ37VHR		EPBMFN5-V005D	90496		

M37

3.7	3696	243	6	01.10-	VQ37VHR		EPBMFN5-V005D	90496		
3.7	3696	246	6	01.11-	VQ37VHR		EPBMFN5-V005D	90496		
3.7 Allrad	3696	246	6	01.11-	VQ37VHR		EPBMFN5-V005D	90496		



MAF



l kW
C
Y
I



Type-Nº

Stock-Nº

Plug In
Alternative
Type-Nº

Plug In
Stock-Nº

ISUZU

D-MAX I (TFR, TFS) | RODEO

2.5	2499	57	4	06.03-10.04	4JA1-TC		EPBMFT5-V035H	94119		
2.5 DiTD	2499	74	4	10.02-06.12	4JA1-TC		EPBMFT5-V035H	94119		
2.5 DiTD 4x4	2499	74	4	05.02-06.12	4JA1-TC		EPBMFT5-V035H	94119		
3.0 DiTD 4x4	2999	96	4	05.02-06.12	4JH1-TC		EPBMFT5-V035H	94119		

IVECO

DAILY V (26_, 33_, 35_, 40_, 45_, 50_, 60_, 65_, 70)

26L11, 26L11D, 35C11D, 35S11, 40C11	2287	78	4	09.11-02.14	F1AE3481A		EPBMFT4-V061H	94528		
29L11V, 35C11V, 35S11V, 40C11V	2287	78	4	09.11-02.14	F1AE3481A		EPBMFT4-V061H	94528		
35C11K, 35S11DKP	2287	78	4	09.11-02.14	F1AE3481A		EPBMFT4-V061H	94528		
29L13, 29L13D, 35C13D, 40C13	2287	93	4	09.11-02.14	F1AE3481B		EPBMFT4-V061H	94528		
29L13V, 35C13V, 35S13V, 40C13V, 40S13V	2287	93	4	09.11-02.14	F1AE3481B		EPBMFT4-V061H	94528		
35C13K, 35C13DKP	2287	93	4	09.11-02.14	F1AE3481B		EPBMFT4-V061H	94528		
29L15V, 35S15, 35C15LV, 40C15LV, 50C15LV	2287	107	4	09.11-02.14	F1AE3481C		EPBMFT4-V061H	94528		
29L15V, 35S15V, 35C15LV, 40C15LV, 50C15LV	2287	107	4	09.11-02.14	F1AE3481C		EPBMFT4-V061H	94528		
35C15, 35C15D, 35S15, 40C15, 45C15, 50C15, 60C15, 65C15, ...	2998	107	4	09.11-02.14	F1CE3481J		EPBMFT4-V061H	94528		
35C15V, 40C15V, 45C15V, 50C15V, 60C15V, 65C15V	2998	107	4	09.11-02.14	F1CE3481J, F1CE3481B		EPBMFT4-V061H	94528		
35C17, 35C17D, 35S17, 40C17, 45C17, 50C17, 60C17, 70C17	2998	125	4	09.11-02.14	F1CE3481C, F1CE3481K		EPBMFT4-V061H	94528		
35C17K, 35S17DKP, 50C17K, 65C17DK, 70C17K	2998	125	4	09.11-02.14	F1CE3481C, F1CE3481K		EPBMFT4-V061H	94528		
35C17V, 35S17V, 40C17V, 45C17V, 50C17V, 60C17V	2998	125	4	09.11-02.14	F1CE3481C, F1CE3481K		EPBMFT4-V061H	94528		
55S17W 4x4	2998	125	4	09.11-02.14	F1CE3481C		EPBMFT4-V061H	94528		
35C21 V, 35S21 V, 40C21 V, 45C21 V, 50C21 V	2998	150	4	09.11-02.14	F1CE3481D		EPBMFT4-V061H	94528		
35C21, 35S21, 40C21, 45C21, 50C21, 60C21, 70C21	2998	150	4	09.11-02.14	F1CE3481D		EPBMFT4-V061H	94528		

DAILY VI (33_, 35_, 40_, 45_, 50_, 55_, 65_, 70_)

33S11, 35S11, 35C11	2287	78	4	03.14-04.16	F1AFL411A		EPBMFT4-V061H	94528		
33S13, 35S13, 35C13	2287	93	4	03.14-04.16	F1AFL411B		EPBMFT4-V061H	94528		
33S15, 35S15, 35C15	2287	107	4	03.14-04.16	F1AFL411C		EPBMFT4-V061H	94528		
35S14, 35S15, 35C15, 40S14, 40C15, 50C15, 65C15, 70C15	2998	107	4	03.14-04.16	F1CE3481J, F1CFL411J, F1CFL411E		EPBMFT4-V061H	94528		
35S15, 35C15, 40C15, 50C15, 65C15, 70C15	2998	107	4	03.14-04.16	F1CE3481J, F1CFL411J, F1CFL411E		EPBMFT4-V061H	94528		
40C15, 50C15, 60C15	2998	107	4	06.14-10.16	F1CFL411E		EPBMFT4-V061H	94528		
50C15	2998	107	4	06.14-10.16	F1CFL411E		EPBMFT4-V061H	94528		
55C17	2998	125	4	08.07-03.12	F1CE3481C		EPBMFT4-V061H	94528		
35S17, 35C17, 40C17, 45S17, 45C17, 50C17, 55C17, 65C17, ...	2998	125	4	03.14-04.16	F1CFL411H, F1CFL411F		EPBMFT4-V061H	94528		
35S17, 35C17, 40C17, 50C17, 55C17, 65C17, 70C17	2998	125	4	03.14-04.16	F1CFL411H, F1CFL411F		EPBMFT4-V061H	94528		
40C17, 50C17, 60C17	2998	125	4	06.14-10.16	F1CFL411F		EPBMFT4-V061H	94528		
50C17	2998	125	4	06.14-10.16	F1CFL411F		EPBMFT4-V061H	94528		
50C17, 65C17	2998	125	4	06.14-10.16	F1CFL411F		EPBMFT4-V061H	94528		



MAF



l kW
C
y
I



Type-N°

Stock-N°

Plug In
Alternative
Type-N°

Plug In
Subtype

IVECO

DAILY VI (33_, 35_, 40_, 45_, 50_, 55_, 65_, 70_)

35S21, 35C21, 40C21, 50C21, 65C21, 70C21	2998	150	4	03.14-	F1CFL411G		EPBMFT4-V061H	94528		
--	------	-----	---	--------	-----------	--	---------------	-------	--	--

JAGUAR

S-TYPE (X200)

2.5 V6	2495	147	6	04.02-12.06	AJ25, JB	; Chass.>M45255	EPBMWT5-A005D	93145		
2.7 D	2720	152	6	06.04-10.07	AJD	; Qty. 2	EPBMWT4-A011H	90069		
3.0 V6	2967	175	6	03.99-10.07	AJ-V6, FB	; Chass.>M45255	EPBMWT5-A005D	93145		
4.2 V8	4196	219	8	04.02-10.07	AJ8FT		EPBMWT5-A014D	90205		

XF (X250)

2.2 D	2179	120	4	04.11-04.15	224DT		EPBMWT4-V003D	94395		
2.2 D	2179	140	4	05.11-04.15	224DT		EPBMWT4-V003D	94395		
2.2 D	2179	147	4	03.12-04.15	224DT		EPBMWT4-V003D	94395		
2.7 D	2720	152	6	03.08-04.15	AJD		EPBMWT4-A011H	90069		
3.0	2967	175	6	03.08-04.15	AJ6WG		EPBMWT5-A014D	90205		
3.0 D	2993	155	6	03.09-04.15	AJV6D		EPBMWT4-A011H	90069		
3.0 D	2993	177	6	03.09-04.15	AJV6D, 306DT		EPBMWT4-A011H	90069		
3.0 D	2993	202	6	03.09-04.15	AJV6D, 306DT		EPBMWT4-A011H	90069		
4.2	4196	219	8	03.08-04.15	SV82G		EPBMWT5-A014D	90205		

XJ (X350, X351, X358)

D 2.7	2720	152	6	10.05-03.09	AJD	; Qty. 2	EPBMWT4-A011H	90069		
3.0	2967	175	6	05.03-03.09	AJ-V6		EPBMWT5-A014D	90205		
3.0 V6	2967	175	6	01.11-	AJ-V6		EPBMWT5-A014D	90205		
3.0	2967	179	6	04.04-01.07	AJ-V6		EPBMWT5-A014D	90205		
3.6	3555	190	8	05.03-03.09	RG		EPBMWT5-A014D	90205		
4.2	4196	219	8	05.03-03.09	AJ8FT		EPBMWT5-A014D	90205		
R 4.2	4196	291	8	03.03-06.06	AJ33SC, AJ8FT		EPBMWT5-A005D	93145		

XK 8 (X100)

4.0	3996	209	8	03.96-07.05	AJ26, AJ27, CC, CE	; Chass.>A30645	EPBMWT5-A014D	90205		
4.0	3996	209	8	09.96-08.02	AJ26, AJ27		EPBMWT5-A005D	93145		
4.0	3996	216	8	05.96-07.05	AJ26	; Chass.>A30645	EPBMWT5-A014D	90205		
4.0	3996	267	8	02.98-07.05	EC	; Chass.>A30645	EPBMWT5-A014D	90205		
4.2	4196	219	8	08.02-07.05	AJ8FT	; Chass.>A30645	EPBMWT5-A014D	90205		

X-TYPE (X400)

2.0 D	1998	96	4	02.04-12.09	FMBA, FMBB, R4-X404		EPBMWN4-A002D	91111		
2.1 V6	2099	115	6	03.02-11.09	YB		EPBMWT5-A014D	90205		
2.2 D	2198	107	4	01.07-11.09	QJBA		EPBMWN4-A002D	91111		
2.2 D	2198	110	4	10.05-11.09	QJBA		EPBMWN4-A002D	91111		
2.2 D	2198	114	4	10.05-11.09	QJBA		EPBMWN4-A002D	91111		
2.5 V6 All-wheel Drive	2495	144	6	06.01-11.09	XB		EPBMWT5-A014D	90205		
2.5	2495	144	6	02.04-12.09	XB		EPBMWT5-A014D	90205		



MAF



l kW
C
Y
I



Type-Nº

Stock-Nº

Plug In
Alternative
Type-Nº

Plug In
Subtype

JAGUAR

X-TYPE (X400)

3.0 V6 All-wheel Drive	2967	169	6	06.01-12.08	AJ-V6		EPBMWT5-A014D	90205		
3.0	2967	169	6	02.04-12.09	AJ-V6		EPBMWT5-A014D	90205		

JEEP

COMMANDER (XK, XH)

3.0 CRD 4x4	2987	160	6	04.06-12.10	EXL		EPBMFN4-D014H	92888		
-------------	------	-----	---	-------------	-----	--	---------------	-------	--	--

COMPASS (MK49)

2.0 CRD	1968	103	4	08.06-	ECD, ECE		EPBMFN5-D047H	91140		
2.0 CRD 4x4	1968	103	4	09.06-	ECE		EPBMFN5-D047H	91140		

COMPASS (MP, M6)

2.0 CRD 4x4	1956	103	4	03.17-	EBT		EPBMFT4-V004H	90957		
-------------	------	-----	---	--------	-----	--	---------------	-------	--	--

GRAND CHEROKEE II (WJ, WG)

2.7 CRD 4x4	2685	120	5	10.01-09.05	ENF		EPBMFT5-V033H	95261		
-------------	------	-----	---	-------------	-----	--	---------------	-------	--	--

GRAND CHEROKEE III (WH, WK)

3.0 CRD 4x4	2987	132	6	05.06-12.10	EXL		EPBMFN4-D014H	92888		
3.0 CRD 4x4	2987	155	6	05.06-12.10	EXL		EPBMFN4-D014H	92888		
3.0 CRD	2987	160	6	06.05-12.10	EXL		EPBMFN4-D014H	92888		
3.0 CRD 4x4	2987	160	6	06.05-12.10	EXL		EPBMFN4-D014H	92888		

PATRIOT (MK74)

2.0 CRD	1968	103	4	02.07-12.17	ECD, ECE		EPBMFN5-D047H	91140		
2.0 CRD 4x4	1968	103	4	02.07-12.17	ECD, ECE		EPBMFN5-D047H	91140		

RENEGADE SUV (BU, B1)

1.6 CRD	1598	88	4	07.14-	EJK		EPBMFT4-V004H	90957		
2.0 CRD 4x4	1956	88	4	07.14-	EBT		EPBMFT4-V004H	90957		
2.0 CRD 4x4	1956	103	4	07.14-	EBT		EPBMFT4-V004H	90957		
2.0 CRD 4x4	1956	125	4	07.14-	EBT		EPBMFT4-V004H	90957		

KIA

BONGO PLATFORM/CHASSIS

2.5 CRDi	2497	98	4	01.12-	D4CB	; Euro4, Euro6	EPBMFT5-V002H	97685		
2.9 TDiC	2902	90	4	10.03-	HJ3	; Euro4	EPBMFT5-V002H	97685		
2.9 TDiC 4WD	2902	90	4	10.03-	HJ3	; Euro4	EPBMFT5-V002H	97685		

CARENS I (FC)

1.8 i	1793	81	4	11.00-07.02	T8		EPBMFN4-A035H	97899		
-------	------	----	---	-------------	----	--	---------------	-------	--	--

CARENS II MPV (FJ)

2.0 CVT	1975	102	4	04.05-08.06	G4GC		EPBMWT5-D012H	91007		
2.0 CRDi	1991	83	4	10.02-08.06	D4EA		EPBMFT5-V017H	90311		
2.0 CRDi	1991	83	4	07.02-	D4EA	; Euro4	EPBMFT5-V002H	97685		
2.0 CRDi	1991	103	4	11.05-	D4EA-F		EPBMFT5-V017H	90311		

CARENS III MPV (UN)

1.6 CRDi 110	1582	85	4	10.10-	D4FB		EPBMFT5-V005H	93645		
1.6 CRDi 128	1582	94	4	10.10-	D4FB		EPBMFT5-V005H	93645		
2.0 CRDi 115	1991	85	4	05.07-	D4EA		EPBMFT5-V002H	97685		



MAF



l kW
C
y
I



Type-Nº

Stock-Nº

Plug In
Alternative
Type-Nº

Plug In
Subtype

KIA

CARENS III MPV (UN)

2.0 CRDi 135	1991	100	4	08.09-	D4EA		EPBMFT5-V002H	97685		
--------------	------	-----	---	--------	------	--	---------------	-------	--	--

CARENS IV

1.7 CRDi	1685	85	4	03.13-	D4FD		EPBMFT5-V005H	93645		
1.7 CRDi	1685	100	4	03.13-	D4FD		EPBMFT5-V005H	93645		
1.7 CRDi	1685	104	4	07.15-	D4FD		EPBMFT5-V005H	93645		

CARNIVAL / GRAND CARNIVAL III (VQ) | SEDONA

2.9 CRDi	2902	136	4	06.06-	J3		EPBMFT5-V002H	97685		
2.9 CRDi LX	2902	141	4	09.06-	J3		EPBMFT5-V002H	97685		

CARNIVAL I (UP) | SEDONA

2.5 V6	2497	121	6	08.99-10.01	KRV6		EPBMWN3-A001H	97106		
2.9 TD	2903	93	4	08.99-10.01	J3		EPBMFT5-V030H	96975		

CARNIVAL II (GQ) | SEDONA

2.5 V6	2497	110	6	10.01-06.06	K5		EPBMFT5-V033H	95261		
2.9 CRDi	2902	106	4	10.01-06.06	J3		EPBMFT5-V030H	96975	EPBMFT5-V001P	93006

CEE'D / PRO CEE'D (ED)

1.6 CRDi 90	1582	66	4	09.07-12.12	D4FB-L		EPBMFT5-V005H	93645		
1.6 CRDi 115	1582	85	4	09.07-12.12	D4FB		EPBMFT5-V005H	93645		
1.6 CRDi 128	1582	94	4	10.10-12.12	D4FB		EPBMFT5-V005H	93645		
2.0 CRDi 140	1991	100	4	07.07-12.12	D4EA		EPBMFT5-V002H	97685		
2.0 CRDi 140	1991	103	4	07.07-12.12	D4EA		EPBMFT5-V002H	97685		

CEE'D / PRO CEE'D (JD)

1.4 CRDi 90	1396	66	4	05.12-	D4FC		EPBMFT5-V005H	93645		
1.4 CRDi	1396	66	4	04.15-	D4FC		EPBMFT5-V005H	93645		
1.6 CRDi 110	1582	81	4	03.13-	D4FB		EPBMFT5-V005H	93645		
1.6 CRDi	1582	94	4	07.12-	D4FB		EPBMFT5-V005H	93645		
1.6 CRDi 128	1582	94	4	05.12-	D4FB		EPBMFT5-V005H	93645		
1.6 CRDi 136	1582	100	4	07.15-	D4FB		EPBMFT5-V005H	93645		

CEED / PROCEED (GD)

1.6 CRDi 115	1598	85	4	03.18-	D4FE		EPBMFT5-V005H	93645		
CRDi 115	1598	85	4	03.18-	D4FE		EPBMFT5-V005H	93645		
1.6 CRDi 136	1598	100	4	03.18-	D4FE		EPBMFT5-V005H	93645		
CRDi 136	1598	100	4	03.18-	D4FE		EPBMFT5-V005H	93645		

CERATO I (LD)

1.5 CRDi	1493	54	4	12.05-08.06	D4FA		EPBMFT5-V005H	93645		
1.5 CRDi	1493	54	4	07.05-11.05	D4FA		EPBMFT5-V053H	95935		
1.5 CRDi	1493	66	4	12.05-12.09	D4FA		EPBMFT5-V005H	93645		
1.5 CRDi	1493	66	4	07.05-11.05	D4FA		EPBMFT5-V053H	95935		
1.5 CRDi	1493	75	4	12.05-	D4FA		EPBMFT5-V005H	93645		
1.5 CRDi	1493	75	4	07.05-11.05	D4FA		EPBMFT5-V053H	95935		



MAF



l kW C Y I



Type-N°

Stock-N°

Plug In Alternative Type-N°

Plug In Stock-N°

KIA

CERATO I (LD)

1.6 CRDi	1582	85	4	06.05-	D4FB		EPBMFT5-V005H	93645		
1.6	1594	75	4	04.04-12.09	G4FC, G4ED		EPBMFT5-V017H	90311		
1.6	1599	77	4	04.04-12.09	G4ED		EPBMFT5-V017H	90311		
2.0	1975	105	4	04.04-10.06	G4GC		EPBMWT5-D012H	91007		
2.0 CRDi	1991	83	4	04.04-	D4EA		EPBMFT5-V053H	95935		

CLARUS (K9A)

1.8 i 16V	1793	85	4	06.99-08.01	T8		EPBMWN3-A001H	97106		
2.0 i 16V	1998	98	4	06.99-11.01	FE		EPBMWN3-A001H	97106		

K2500 (SD) | FRONTIER

2.5 CRDi	2497	96	4	01.10-	D4CB		EPBMFT5-V002H	97685		
----------	------	----	---	--------	------	--	---------------	-------	--	--

K2900

2.9 D	2902	92	4	01.08-	J3	Euro4	EPBMFT5-V002H	97685		
-------	------	----	---	--------	----	-------	---------------	-------	--	--

MAGENTIS (GD, MS)

2.5 V6	2493	124	6	07.01-05.04	G6BV		EPBMWN3-A017H	95114		
--------	------	-----	---	-------------	------	--	---------------	-------	--	--

MAGENTIS (MG) | LOTZE

2.0 CRDi	1991	100	4	11.05-12.08	D4EA		EPBMFT5-V002H	97685		
2.0 CRDi	1991	103	4	04.06-	D4EA		EPBMFT5-V002H	97685		
2.0 CRDi	1991	110	4	04.06-	D4EA		EPBMFT5-V002H	97685		

OPIRUS (GH)

3.5	3497	149	6	09.03-	G6CU		EPBMFT5-V001P	93006		
-----	------	-----	---	--------	------	--	---------------	-------	--	--

OPTIMA (FSGDS6B)

1.7 CRDi	1685	100	4	03.12-	D4FD		EPBMFT5-V005H	93645		
----------	------	-----	---	--------	------	--	---------------	-------	--	--

OPTIMA (JF)

1.6 CRDi	1598	100	4	01.18-	D4FE		EPBMFT5-V005H	93645		
1.7 CRDi	1685	99	4	09.16-	D4FD		EPBMFT5-V005H	93645		
1.7 CRDi	1685	104	4	09.16-	D4FD		EPBMFT5-V005H	93645		

RIO (DC_)

1.3	1343	55	4	07.01-07.03	A3E		EPBMFN3-A028H	94128		
1.3	1343	60	4	07.03-02.05	A3E		EPBMFN3-A028H	94128		
1.5	1493	70	4	09.02-02.05	A5D		EPBMFN3-A028H	94128		
1.5 16V	1493	71	4	09.02-02.05	A5D		EPBMFN3-A028H	94128		
1.5 16V	1493	72	4	07.01-07.02	A5D		EPBMFN3-A028H	94128		

RIO II (JB)

1.5 CRDi	1493	65	4	06.08-	D4FA		EPBMFT5-V005H	93645		
1.5 CRDi	1493	81	4	03.05-	D4FA		EPBMFT5-V005H	93645		

RIO III (UB)

1.1 CRDi	1120	55	3	09.11-	D3FA		EPBMFT5-V005H	93645		
1.4 CRDi	1396	66	4	04.15-	D4FC		EPBMFT5-V005H	93645		

RIO IV (YB, SC, FB)

1.4 CRDi 77	1396	57	4	01.17-	D4FC		EPBMFT5-V005H	93645		
1.4 CRDi 90	1396	66	4	01.17-	D4FC		EPBMFT5-V005H	93645		



MAF



l kW
C
Y
I



Type-Nº

Stock-Nº

Plug In
Alternative
Type-Nº

Plug In
Subtype

KIA

SORENTO I (JC)

2.4	2351	102	4	-04.06	G4JS		EPBMFT5-V017H	90311		
2.5 CRDi	2497	103	4	08.02-	D4CB		EPBMFT5-V030H	96975	EPBMFT5-V001P	93006
2.5 CRDi	2497	103	4	05.06-	D4CB		EPBMFT5-V002H	97685		
2.5 CRDi	2497	120	4	05.06-	D4CB		EPBMFT5-V002H	97685		
2.5 CRDi	2497	125	4	12.06-	D4CB		EPBMFT5-V002H	97685		
3.5 V6 4WD	3497	143	6	03.03-08.09	G6CU		EPBMFT5-V001P	93006		

SOUL I (AM)

1.6 CRDi 115	1582	85	4	02.09-	D4FB		EPBMFT5-V005H	93645		
1.6 CRDi 128	1582	94	4	02.09-	D4FB		EPBMFT5-V005H	93645		
1.6 CVT	1591	77	4	02.09-	G4FC		EPBMFT5-V005H	93645		
1.6 LPG	1591	92	4	02.09-12.14	G4FC		EPBMFT5-V005H	93645		
1.6 CVT	1591	93	4	02.09-	G4FC		EPBMFT5-V005H	93645		

SOUL II (PS)

1.6 CRDi 128	1582	94	4	02.14-	D4FB		EPBMFT5-V005H	93645		
1.6 CRDi 136	1582	100	4	04.15-	D4FB		EPBMFT5-V005H	93645		

SPORTAGE (QL, QLE)

1.6 CRDi	1598	85	4	07.18-	D4FE		EPBMFT5-V005H	93645		
1.6 CRDi Eco-Dynamics+	1598	85	4	03.19-	D4FE		EPBMFT5-V005H	93645		
1.6 CRDi	1598	100	4	07.18-	D4FE		EPBMFT5-V005H	93645		
1.6 CRDi AWD	1598	100	4	07.18-	D4FE		EPBMFT5-V005H	93645		
1.6 CRDi Eco-Dynamics+	1598	100	4	03.19-	D4FE		EPBMFT5-V005H	93645		
1.6 CRDi Eco-Dynamics+ AWD	1598	100	4	03.19-	D4FE		EPBMFT5-V005H	93645		
1.7 CRDi	1685	85	4	09.15-	D4FD		EPBMFT5-V005H	93645		
1.7 CRDi	1685	104	4	11.16-	D4FD		EPBMFT5-V005H	93645		

SPORTAGE (SL)

1.7 CRDi	1685	85	4	12.10-	D4FD		EPBMFT5-V005H	93645		
----------	------	----	---	--------	------	--	---------------	-------	--	--

SPORTAGE II (JE_, KM)

2.0 i 16V	1975	104	4	09.04-	G4GC		EPBMWT5-D012H	91007		
2.0 16V 4WD	1975	104	4	01.05-12.06	G4GC		EPBMWT5-D012H	91007		
2.0 CRDi 4WD	1991	83	4	09.04-	D4EA		EPBMFT5-V010H	96310		
2.0 CRDi 4WD	1991	83	4	09.04-	D4EA	; for vehicles with VTG turbocharger	EPBMFT5-V002H	97685		
2.0 CRDi	1991	83	4	02.05-10.10	D4EA		EPBMFT5-V010H	96310		
2.0 CRDi	1991	83	4	02.05-	D4EA	; for vehicles with VTG turbocharger	EPBMFT5-V002H	97685		
2.0 CRDi	1991	100	4	01.06-	D4EA	; for vehicles with VTG turbocharger	EPBMFT5-V002H	97685		
2.0 CRDi 4WD	1991	100	4	01.06-	D4EA	; for vehicles with VTG turbocharger	EPBMFT5-V002H	97685		
2.0 CRDi 4WD	1991	103	4	01.06-	D4EA-F	; Engine Model:VGT	EPBMFT5-V002H	97685		



MAF



l kW
C
Y
I



Type-N°

Stock-N°

Plug In
Alternative
Type-N°

Plug In
Subtype

KIA

SPORTAGE II (JE_, KM)

2.0 CRDi	1991	110	4	09.07-05.10	D4EA-F	; Euro3	EPBMFT5-V010H	96310		
2.0 CRDi 4WD	1991	110	4	09.08-05.10	D4EA-F	; Euro3	EPBMFT5-V010H	96310		
2.7 V6 4WD	2656	129	6	01.05-	G6BA		EPBMWN3-A017H	95114		

SPORTAGE SUV (K00)

2.0 i 4WD	1998	70	4	04.94-08.99	FE		EPBMFN4-A035H	97899		
2.0	1998	87	4	10.00-08.03	FE		EPBMFN4-A035H	97899		
2.0 4WD	1998	87	4	10.00-08.03	FE		EPBMFN4-A035H	97899		
2.0 i 16V 4WD	1998	94	4	04.94-06.99	FE		EPBMFN4-A035H	97899		

STONIC (YB)

1.6 CRDi	1582	81	4	07.17-	D4FB		EPBMFT5-V005H	93645		
1.6 CRDi	1598	85	4	08.18-	D4FE		EPBMFT5-V005H	93645		
1.6 CRDi	1598	100	4	08.18-	D4FE		EPBMFT5-V005H	93645		

VENGA (YN)

1.4 CRDi 75	1396	55	4	02.10-	D4FC		EPBMFT5-V005H	93645		
1.4 CRDi 75	1396	57	4	02.10-	D4FC		EPBMFT5-V005H	93645		
CRDi	1396	57	4	04.15-	D4FC		EPBMFT5-V005H	93645		
1.4 CRDi 90	1396	66	4	02.10-	D4FC		EPBMFT5-V005H	93645		
CRDi	1396	66	4	04.15-	D4FC		EPBMFT5-V005H	93645		
1.6 CRDi 115	1582	85	4	02.10-	D4FB		EPBMFT5-V005H	93645		
1.6 CRDi 128	1582	94	4	02.10-	D4FB		EPBMFT5-V005H	93645		

XCEED (CD)

1.6 CRDi 115	1598	85	4	06.19-	D4FE		EPBMFT5-V005H	93645		
1.6 CRDi 136	1598	100	4	06.19-	D4FE		EPBMFT5-V005H	93645		

LADA

110 (2110) | VEGA

1.5	1499	52	4	06.96-09.04	BA32111		EPBMFT5-V039H	90466		
1.5	1499	54	4	01.95-12.05	BA32111		EPBMFT5-V039H	90466		
1.5	1499	57	4	01.95-12.05	VAZ2111	; Euro3; Euro2	EPBMFT5-V039H	90466	EPBMFT5-V001P	93006
1.5 16V	1499	67	4	10.00-12.10	VAZ2112		EPBMFT5-V039H	90466		
1.5 16V	1499	70	4	01.96-12.04	VAZ2112		EPBMFT5-V039H	90466	EPBMFT5-V001P	93006
1.6 LPG	1596	60	4	10.04-03.07	VAZ21114		EPBMFT5-V039H	90466		
1.6	1596	60	4	01.05-12.12	VAZ21114		EPBMFT5-V039H	90466		
1.6	1596	60	4	01.05-12.12	VAZ21114	; Euro3	EPBMFT5-V001P	93006		
1.6	1596	66	4	01.05-04.07	VAZ21124		EPBMFT5-V001P	93006		
1.6	1596	66	4	01.05-04.07	VAZ21124	; Euro3	EPBMFT5-V039H	90466		
1.6 16V	1596	67	4	10.04-12.10	VAZ21124		EPBMFT5-V039H	90466		

111 (2111)

1.5	1499	58	4	10.00-09.04	VAZ2111		EPBMFT5-V039H	90466		
1.5 16V	1499	67	4	10.00-12.04	VAZ2112		EPBMFT5-V039H	90466	EPBMFT5-V001P	93006



MAF



l kW
C
Y
I



Type-Nº

Stock-Nº

Plug In
Alternative
Type-Nº

Plug In
Subtype

LADA

111 (2111)

1.5 16V	1499	70	4	01.95-08.02	VAZ2112		EPBMFT5-V039H	90466		
1.6	1596	60	4	09.04-02.09	VAZ21114		EPBMFT5-V039H	90466	EPBMFT5-V001P	93006
1.6	1596	66	4	09.04-12.07	VAZ21124	; Euro3	EPBMFT5-V039H	90466	EPBMFT5-V001P	93006

112 (2112)

1.5	1499	56	4	10.00-12.05	VAZ2111		EPBMFT5-V039H	90466		
1.5	1499	57	4	01.96-09.04	VAZ2111		EPBMFT5-V039H	90466	EPBMFT5-V001P	93006
1.5 16V	1499	67	4	10.00-12.05	VAZ2112		EPBMFT5-V039H	90466		
1.5 16V	1499	70	4	01.96-09.00	VAZ2112		EPBMFT5-V039H	90466	EPBMFT5-V001P	93006

KALINA (1117, 1118, 1119)

1.4 16V LPG	1390	65	4	11.08-12.13	VAZ11194		EPBMFT5-V039H	90466	EPBMFT5-V001P	93006
1.4 16V	1390	66	4	11.08-12.09	VAZ11194		EPBMFT5-V039H	90466	EPBMFT5-V001P	93006
1.6	1597	60	4	10.04-12.13	VAZ11183, VAZ-21114		EPBMFT5-V039H	90466	EPBMFT5-V001P	93006
1.6	1597	62	4	01.10-12.13	VAZ1110		EPBMFT5-V039H	90466		
1.6	1597	66	4	01.10-12.13	VAZ11186		EPBMFT5-V039H	90466	EPBMFT5-V001P	93006

NIVA CLOSED OFF-ROAD VEHICLE (2121, 2131) | TAIGA

1.7 LPG	1690	57	4	09.02-	BA321214		EPBMFT5-V001P	93006		
1700 i	1690	59	4	06.96-12.06	BA321214, VAZ-21213		EPBMFT5-V039H	90466		
1700 i 4x4	1690	60	4	10.00-12.10	BA321214	; Euro3	EPBMFT5-V039H	90466	EPBMFT5-V001P	93006
1700 i 4x4	1690	61	4	09.10-	BA321214		EPBMFT5-V039H	90466	EPBMFT5-V001P	93006

NIVA II (2123) | TAIGA

1.7	1690	59	4	09.02-	BA321214		EPBMFT5-V039H	90466		
1.7	1690	61	4	06.07-	BA321214		EPBMFT5-V039H	90466	EPBMFT5-V001P	93006

PRIORA (2170, 2171, 2172)

1.6	1597	60	4	12.08-12.13	VAZ21114		EPBMFT5-V039H	90466		
1.6 LPG	1597	71	4	03.09-	VAZ21126	; Not suited for LPG	EPBMFT5-V039H	90466	EPBMFT5-V001P	93006
1.6	1597	72	4	04.07-	VAZ21126	; Not suited for LPG	EPBMFT5-V039H	90466	EPBMFT5-V001P	93006

SAMARA (2108, 2109, 2113, 2114)

1300	1288	50	4	02.96-12.99	BA321115		EPBMFT5-V039H	90466		
1500	1499	52	4	02.95-12.06	BA32111		EPBMFT5-V039H	90466		
1500	1499	53	4	09.87-12.96	BA321083		EPBMFT5-V039H	90466		
1.5	1499	56	4	04.96-12.13	VAZ2111		EPBMFT5-V039H	90466		

SAMARA SALOON (21099, 2115) | VOLUMES | SAMARA FORMA | DIVA | SAGONA

1300	1288	45	4	07.91-08.99	BA32108		EPBMFT5-V039H	90466		
1300	1288	46	4	05.90-08.99	BA32108		EPBMFT5-V039H	90466		
1300	1288	50	4	06.95-12.06	BA321115		EPBMFT5-V039H	90466		
1500	1499	50	4	07.91-12.96	BA321083		EPBMFT5-V039H	90466		
1500	1499	52	4	11.94-12.06	BA32111		EPBMFT5-V039H	90466		
1.5	1499	57	4	01.00-12.06	VAZ2111		EPBMFT5-V039H	90466		
1.5	1499	59	4	08.03-12.06	VAZ2111		EPBMFT5-V039H	90466		



MAF
 l kW
C
Y
I

Type-N°

Stock-N°

Plug In
Alternative
Type-N°Plug In
Subtype**LAMBORGHINI****GALLARDO**

5.2 LP 550-2	5204	405	10	09.09-09.14	CEH	OE 420133471	EPBMWT5-V013D	92480		
--------------	------	-----	----	-------------	-----	--------------	---------------	-------	--	--

GALLARDO / GALLARDO SPYDER

5.2 LP560-4	5204	412	10	06.08-	CMPA	OE 420133471	EPBMWT5-V013D	92480		
-------------	------	-----	----	--------	------	--------------	---------------	-------	--	--

LANCIA**DELTA III (844_)**

1.6 D Multijet	1598	77	4	04.11-08.14	944A3000		EPBMFT4-V004H	90957		
1.6 D Multijet	1598	85	4	08.08-08.14	955A4000		EPBMFT4-V004H	90957		
1.6 D Multijet	1598	88	4	09.08-08.14	198A2000		EPBMFT4-V004H	90957		
1.9 D Multijet	1910	140	4	01.09-08.14	844A1000		EPBMFT4-V061H	94528		
2.0 D Multijet	1956	120	4	09.08-08.14	844A2000		EPBMFT4-V004H	90957		
2.0 D Multijet	1956	121	4	09.08-08.14	198A5000, 198A8000		EPBMFT4-V004H	90957		

KAPPA (838_)

2.0 20V	1998	114	5	06.98-12.00	838A6000		EPBMFT5-V001P	93006		
2.4 JTD	2387	100	5	06.98-10.01	838A8000		EPBMFT5-V001P	93006		
2.4 20V	2446	129	5	06.98-06.00	832B2000, 838B2000		EPBMFT5-V001P	93006		
3.0 24V	2959	150	6	07.96-10.01	838B000	; Chass.>2092371; Chass.>7002900	EPBMFT5-V008H	93715		

LYBRA (839_)

1.6 16V	1581	76	4	07.99-10.05	182A4000		EPBMFT5-V017H	90311	EPBMFT5-V001P	93006
1.6	1596	76	4	10.00-10.05	182B6000		EPBMFT5-V001P	93006		
1.8 16V	1747	96	4	07.99-09.05	839A4000, 839A7000, 839A9000		EPBMFT5-V001P	93006		
1.9 JTD	1910	77	4	07.99-09.00	AR32302		EPBMFT5-V001P	93006		
1.9 JTD	1910	81	4	09.00-05.01	AR37101		EPBMFT5-V001P	93006		
1.9 JTD	1910	85	4	05.01-10.05	937A2000		EPBMFT5-V001P	93006		
2.0 20V	1998	110	5	09.00-09.05	185A8000		EPBMFT5-V001P	93006		
2.0 20V	1998	113	5	07.99-09.00	182B7000		EPBMFT5-V001P	93006		
2.4 JTD	2387	99	5	07.99-09.00	839A5000, AR32501		EPBMFT5-V001P	93006		
2.4 JTD	2387	103	5	09.00-05.02	839A6000		EPBMFT5-V001P	93006		
2.4 JTD	2387	110	5	05.02-10.05	841C000		EPBMFT5-V001P	93006		

MUSA (350_)

1.3 D Multijet	1248	51	4	10.04-09.12	188A9000		EPBMFT5-V001P	93006		
1.3 D Multijet	1248	51	4	10.04-09.12	188A9000	; Euro5	EPBMFT4-V004H	90957		
1.3 D Multijet	1248	51	4	07.07-09.12	188A9000	Euro4	EPBMFN4-V017H	96226		
1.3 D Multijet	1248	66	4	09.06-09.12	199A3000	Euro4	EPBMFN4-V017H	96226		
1.3 D Multijet	1248	66	4	09.06-09.12	199A3000	; Euro5	EPBMFT4-V004H	90957		
1.3 D Multijet	1248	70	4	03.09-09.12	199B1000	Euro4	EPBMFN4-V017H	96226		
1.3 D Multijet	1248	70	4	03.09-09.12	199B1000	; Euro5	EPBMFT4-V004H	90957		
1.4	1368	57	4	09.05-09.12	350A1000		EPBMFT5-V029H	90502	EPBMFT5-V001P	93006
1.4	1368	66	4	10.07-09.12	192B2000		EPBMFT5-V029H	90502	EPBMFT5-V001P	93006



MAF



l kW
C
Y
I



Type-N°

Stock-N°

Plug In
Alternative
Type-N°

Plug In
Stock-N°

LANCIA

MUSA (350_)

1.4	1368	70	4	10.04-09.12	843A1000		EPBMFT5-V029H	90502	EPBMFT5-V001P	93006
1.6 D Multijet	1598	85	4	07.08-09.12	350A2000		EPBMFT4-V004H	90957		
1.6 D Multijet	1598	85	4	07.08-09.12	350A3000		EPBMFT4-V004H	90957		
1.6 D Multijet	1598	88	4	07.08-09.12	350A2000		EPBMFT4-V004H	90957		
1.9 D Multijet	1910	74	4	10.04-09.12	188B2000		EPBMFN4-V026H	94497		
1.9 D Multijet	1910	74	4	10.04-09.12	188B2000		EPBMFN4-V010H	97588		

PHEDRA (179_)

2.0 JTD	1997	79	4	07.03-11.10	RHM		EPBMWT5-A005H	93383		
2.0 JTD	1997	80	4	09.02-11.10	RHW		EPBMWT5-A005H	93383		
2.0	1997	100	4	09.02-11.10	RFN		EPBMWT4-A008H	90627		
2.0 D Multijet	1997	100	4	07.06-11.10	RHR		EPBMWT4-A008H	90627		
2.2 JTD	2179	94	4	09.02-11.10	4HW	; 4 pin connector	EPBMWT4-A008H	90627		
2.2 JTD	2179	94	4	09.02-11.10	4HW	; 5 pin connector	EPBMWT5-A005H	93383		
2.2 JTD	2179	120	4	04.06-11.10	4HP, 4HR		EPBMWT4-A008H	90627		
2.2 D Multijet	2179	125	4	03.08-11.10	4HS, 4HT		EPBMWT4-A008H	90627		

THEISIS (841_)

2.4 JTD	2387	110	5	07.02-05.05	841C000		EPBMFT5-V001P	93006		
2.4 JTD	2387	120	5	09.03-07.09	841M000, 841N000		EPBMFT5-V035H	94119	EPBMFT5-V001P	93006
2.4 JTD	2387	129	5	05.03-07.09	841G000		EPBMFT5-V035H	94119	EPBMFT5-V001P	93006
2.4 D Multijet	2387	136	5	04.06-07.09	841P000		EPBMFN4-V020H	90971		
2.4	2446	125	5	07.02-07.09	841D000		EPBMFT5-V001P	93006		

YPSILON (312_)

1.3 D Multijet	1248	70	4	05.11-	199B1000, 312B1000		EPBMFT4-V004H	90957		
----------------	------	----	---	--------	-----------------------	--	---------------	-------	--	--

YPSILON (843_)

1.3 JTD	1248	51	4	10.03-09.06	188A9000		EPBMFT5-V029H	90502	EPBMFT5-V001P	93006
1.3 JTD	1248	51	4	10.03-12.11	188A9000		EPBMFN4-V017H	96226		
1.3 D Multijet	1248	55	4	09.06-10.07	199A2000	Euro4	EPBMFN4-V017H	96226		
1.3 D Multijet	1248	55	4	09.06-09.11	199A2000	; Euro5	EPBMFT4-V004H	90957		
1.3 D Multijet	1248	66	4	09.06-12.11	199A3000		EPBMFN4-V017H	96226		
1.3 D Multijet	1248	77	4	05.07-12.11	199A3000		EPBMFN4-V017H	96226		

ZETA (22_)

2.0 JTD	1997	80	4	09.99-09.02	RHZ		EPBMWT5-A003H	93842		
2.0 JTD 16V	1997	80	4	09.99-09.02	RHW		EPBMWT5-A003H	93842		

LAND ROVER

DEFENDER (L316)

2.2 Td4 4x4	2198	90	4	08.11-02.16	DT224		EPBMWT4-A001D	95860		
2.4 Td4 4x4	2402	90	4	05.07-02.16	DT244		EPBMWT4-A001D	95860		
2.5 Td5 4x4	2495	90	5	11.98-06.06	10P, 14P, 15P		EPBMWN3-A001H	97106		

DISCOVERY II (L318)

2.5 Td5 4x4	2495	102	5	11.98-06.04	10P, 15P		EPBMWN3-A001H	97106		
-------------	------	-----	---	-------------	----------	--	---------------	-------	--	--



MAF



l kW
C
Y
I



Type-N°

Stock-N°

Plug In
Alternative
Type-N°

Plug In
Stock-N°

LAND ROVER

DISCOVERY III (L319)

2.7 TD 4x4	2720	140	6	07.04-09.09	276DT		EPBMWT4-D018H	96715		
4.0 V6 4x4	4009	160	6	10.04-09.09	406PN		EPBMWT5-A014D	90205		
4.4 4x4	4394	220	8	07.04-09.09	448PN		EPBMWT5-A014D	90205		

DISCOVERY IV (L319)

3.0 TD 4x4	2993	155	6	01.11-12.17	306DT	; Qty. 2	EPBMWT4-A011H	90069		
3.0 TD 4x4	2993	180	6	01.11-12.17	306DT	; Qty. 2	EPBMWT4-A011H	90069		
3.0 TD 4x4	2993	183	6	07.12-	306DT	; Qty. 2	EPBMWT4-A011H	90069		
3.0 SDV6 4x4	2993	188	6	11.09-	306DT	; Qty. 2	EPBMWT4-A011H	90069		
3.0 TD 4x4	2993	188	6	01.11-12.17	306DT	; Qty. 2	EPBMWT4-A011H	90069		
3.0 TD 4x4	2993	200	6	09.09-	306DT	; Qty. 2	EPBMWT4-A011H	90069		

DISCOVERY SPORT (L550)

2.0 4x4	1999	177	4	11.14-	204PT		EPBMWT4-V003D	94395		
2.2 D 4x4	2179	110	4	09.14-	224DT		EPBMWT4-V003D	94395		
2.2 D 4x4	2179	140	4	09.14-	224DT		EPBMWT4-V003D	94395		

FREELANDER (L314)

2.0 Td4 4x4	1951	80	4	03.01-10.06	204D3		EPBMFT5-D015H	92304	EPBMFT5-D003P	96835
2.0 Td4 4x4	1951	82	4	11.00-10.06	204D3, M47		EPBMFT5-D015H	92304	EPBMFT5-D003P	96835
2.0 DI 4x4	1994	72	4	02.98-08.00	20T2N		EPBMFN5-V043H	93581		
2.5 V6 4x4	2497	130	6	11.00-10.06	25K4F	OE MHK100620	EPBMWN3-A001H	97106		

FREELANDER 2 (L359)

2.0 Si4 4x4	1999	177	4	10.11-10.14	204PT		EPBMWT4-V003D	94395		
2.2 TD4 4x4	2179	110	4	10.06-10.14	224DT, DW12BTED4		EPBMWT4-V003D	94395		
2.2 TD4 4x4	2179	110	4	10.06-10.14	224DT, DW12BTED4		EPBMWT4-A001D	95860		
2.2 eD4	2179	110	4	08.10-10.14	224DT, DW12BTED4		EPBMWT4-V003D	94395		
2.2 TD4 4x4	2179	112	4	01.07-10.14	224DT		EPBMWT4-V003D	94395		
2.2 TD4 4x4	2179	112	4	01.07-10.14	224DT		EPBMWT4-A001D	95860		
2.2 TD4 4x4	2179	115	4	10.06-10.14	224DT		EPBMWT4-V003D	94395		
2.2 TD4 4x4	2179	115	4	10.06-10.14	224DT		EPBMWT4-A001D	95860		
2.2 TD4 4x4	2179	118	4	10.06-10.14	224DT, DW12BTED4		EPBMWT4-V003D	94395		
2.2 TD4 4x4	2179	118	4	10.06-10.14	224DT, DW12BTED4		EPBMWT4-A001D	95860		
2.2 SD4 4x4	2179	140	4	08.10-10.14	224DT		EPBMWT4-V003D	94395		
3.2 4x4	3192	171	6	10.06-10.14	B6324S		EPBMWT5-A014D	90205		

RANGE ROVER EVOQUE (L538)

2.0 4x4	1999	177	4	06.11-	204PT		EPBMWT4-V003D	94395		
2.2 D	2179	110	4	06.11-	224DT		EPBMWT4-V003D	94395		
2.2 D 4x4	2179	110	4	06.11-	224DT		EPBMWT4-V003D	94395		
2.2 D 4x4	2179	140	4	06.11-	224DT		EPBMWT4-V003D	94395		





RANGE ROVER II (P38A)

2.5 D 4x4	2497	100	6	07.94-03.02	256T		EPBMFN6-R030H	90274		
-----------	------	-----	---	-------------	------	--	---------------	-------	--	--







LAND ROVER

RANGE ROVER III (L322)

3.6 D 4x4	3628	200	8	04.06-08.12	368DT	 ; Qty. 2	EPBMWT4-A011H	90069		
4.2 4x4	4197	291	8	05.05-08.12	428PS		EPBMWT5-A014D	90205		
4.4 4x4	4394	225	8	05.05-08.12	448PN		EPBMWT5-A014D	90205		
4.4 4x4	4398	210	8	03.02-04.05	M62B44	 	EPBMFT5-D060H	95878		

RANGE ROVER SPORT (L320)



2.7 D 4x4	2720	140	6	02.05-03.13	276DT		EPBMWT4-D018H	96715		
3.0 D 4x4	2993	155	6	05.10-03.13	30DDTX		EPBMWT4-A011H	90069		
3.0 D 4x4	2993	180	6	09.09-03.13	30DDTX		EPBMWT4-A011H	90069		
3.0 D 4x4	2993	188	6	06.11-03.13	30DDTX		EPBMWT4-A011H	90069		
3.6 D 4x4	3628	200	8	04.06-03.13	368DT	 ; Qty. 2	EPBMWT4-A011H	90069		
4.2 4x4	4197	287	8	02.05-03.13	428PS		EPBMWT5-A014D	90205		
4.2 4x4	4197	291	8	01.06-02.10	428PS		EPBMWT5-A014D	90205		
4.4 4x4	4394	220	8	02.05-03.13	448PN		EPBMWT5-A014D	90205		

LEXUS





CT (ZWA10_)

200h	1798	73	4	12.10-	2ZR-FXE, 5ZR-FXE		EPBMFT5-V002D	97692		
------	------	----	---	--------	------------------	--	---------------	-------	--	--

ES (_V6_)

300h	2494	118	4	06.12-06.18	2AR-FXE		EPBMFT5-V002D	97692		
250	2494	135	4	06.12-06.18	2AR-FE		EPBMFT5-V002D	97692		
350	3456	204	6	06.12-06.18	2GR-FE		EPBMFT5-V002D	97692		





GS (_L1_)

250	2499	154	6	01.12-	4GR-FSE		EPBMFT5-V002D	97692		
250	2499	158	6	01.12-	4GR-FSE		EPBMFT5-V002D	97692		
450h	3456	215	6	01.12-	2GR-FXE		EPBMFT5-V002D	97692		
450h	3456	217	6	01.12-	2GR-FXE		EPBMFT5-V002D	97692		
350 AWD	3456	234	6	12.11-	2GR-FSE		EPBMFT5-V002D	97692		
350	3456	234	6	01.12-	2GR-FSE		EPBMFT5-V002D	97692		

GS (_S16_)

300	2997	161	6	10.00-12.04	2JZ-GE		EPBMWT5-A014D	90205		
-----	------	-----	---	-------------	--------	---	---------------	-------	--	--

GS (_S19_)

300	2994	170	6	04.05-11.11	3GR-FE		EPBMWT5-A014D	90205		
300	2995	183	6	04.05-11.11	3GR-FSE		EPBMWT5-A014D	90205		
450h	3456	218	6	02.06-11.11	2GR-FSE		EPBMWT5-A014D	90205		
450h	3456	254	6	02.06-11.11	2GR-FSE		EPBMWT5-A014D	90205		
430	4293	208	8	04.05-11.11	3UZ-FE		EPBMWT5-A014D	90205		

IS C (GSE2_)

250	2499	153	6	04.09-06.15	4GR-FSE		EPBMWT5-A006D	91258		
-----	------	-----	---	-------------	---------	---	---------------	-------	--	--

IS I (_E1_)

300	2997	157	6	09.01-07.05	2JZ-GE		EPBMWT5-A014D	90205		
-----	------	-----	---	-------------	--------	---	---------------	-------	--	--

MAF



l kW
C
Y
I



Type-Nº

Stock-Nº

Plug In
Alternative
Type-Nº

Plug In
Alternative

LEXUS

IS II (_E2_)

220d	2231	130	4	08.05-08.10	2AD-FHV		EPBMWT5-A014D	90205		
250	2499	153	6	08.05-03.13	4GR-FSE		EPBMWT5-A006D	91258		

IS SPORTCROSS (_E1_)

300	2997	157	6	10.01-10.05	2JZ-GE		EPBMWT5-A014D	90205		
-----	------	-----	---	-------------	--------	--	---------------	-------	--	--

LFA (LFA10_)

4.8	4805	412	10	12.10-11.12	1LR-GUE		EPBMFT5-V002D	97692		
4.8	4805	420	10	11.11-11.12	1LR-GUE		EPBMFT5-V002D	97692		

LS (_F3_)

430	4293	207	8	08.00-08.06	3UZ-FE		EPBMWT5-A014D	90205		
430	4293	208	8	10.00-08.06	3UZ-FE		EPBMWT5-A014D	90205		

RX (_L1_)

270	2671	138	4	12.08-10.15	1AR-FE		EPBMFT5-V002D	97692		
350 AWD	3456	204	6	12.08-08.15	2GR-FE, 2GR-FXE		EPBMWT5-A006D	91258		
350 AWD	3456	204	6	12.08-08.15	2GR-FE, 2GR-FXE		EPBMFT5-V002D	97692		
350	3456	206	6	12.08-10.15	2GR-FXE		EPBMFT5-V002D	97692		
350 AWD	3456	206	6	03.09-02.12	2GR-FE		EPBMFT5-V002D	97692		
450h	3456	183	6	12.08-10.15	2GR-FXE		EPBMFT5-V002D	97692		
450h AWD	3456	183	6	12.08-10.15	2GR-FXE		EPBMFT5-V002D	97692		

RX (_U3_)

300	2995	150	6	05.03-12.08	1MZ-FE		EPBMWT5-A014D	90205		
330	3311	171	6	04.03-01.06	3MZ-FE		EPBMWT5-A014D	90205		
330 AWD	3311	171	6	04.03-12.08	3MZ-FE		EPBMWT5-A014D	90205		
350 AWD	3456	203	6	02.06-12.08	2GR-FE		EPBMWT5-A006D	91258		
400h	3311	155	6	09.05-12.08	3MZ-FE		EPBMWT5-A014D	90205		
400h AWD	3311	155	6	09.04-12.08	3MZ-FE		EPBMWT5-A014D	90205		

LTI

TX

2.5 TD	2499	75	4	01.06-	R425DOHC		EPBMFN4-V010H	97588		
--------	------	----	---	--------	----------	--	---------------	-------	--	--

MAN

TGE

2.0 TDI	1968	75	4	02.17-	DAUB	Type:U*, Type:*V	EPBMFN4-V008H	95035		
2.0 TDI RWD	1968	90	4	08.17-	DASA	Type:U*, Type:*V	EPBMFN4-V008H	95035		
2.0 TDI	1968	103	4	02.17-	DAUA	Type:U*, Type:*V	EPBMFN4-V008H	95035		
2.0 TDI AWD	1968	103	4	02.17-	DAUA	Type:U*, Type:*V	EPBMFN4-V008H	95035		
2.0 TDI RWD	1968	103	4	10.17-	DASB	Type:U*, Type:*V	EPBMFN4-V008H	95035		
2.0 TDI RWD	1968	130	4	05.17-	DAWA	Type:U*, Type:*V	EPBMFN4-V008H	95035		

TGE (UZ_)

2.0 TDI	1968	75	4	11.16-	DAUB	Type:U*, Type:*V	EPBMFN4-V008H	95035		
2.0 TDI RWD	1968	90	4	08.17-	DASA	Type:U*, Type:*V	EPBMFN4-V008H	95035		
2.0 TDI	1968	103	4	11.16-	DAUA	Type:U*, Type:*V	EPBMFN4-V008H	95035		
2.0 TDI AWD	1968	103	4	11.17-	DAUA	Type:U*, Type:*V	EPBMFN4-V008H	95035		



MAF



l kW
C
y
I



Type-Nº

Stock-Nº

Plug In
Alternative
Type-Nº

Plug In
Subtype

MAN

TGE (UZ_)

2.0 TDI RWD	1968	103	4	11.17-	DASB	Type:U*, Type:*V	EPBMFN4-V008H	95035		
2.0 TDI RWD	1968	130	4	07.17-	DAWA	Type:U*, Type:*V	EPBMFN4-V008H	95035		

MAZDA

2 (DE_, DH_)

1.3	1349	55	4	10.07-06.15	ZJ-VE		EPBMWT5-A005D	93145		
1.3 BiFuel	1349	55	4	05.11-11.14	ZJ-46		EPBMWT5-A014D	90205		
1.3 MZR	1349	62	4	01.10-06.15	ZJ-VE		EPBMWT5-A014D	90205		
1.3 BiFuel	1349	62	4	05.11-11.14	ZJ-46		EPBMWT5-A014D	90205		
1.3	1349	63	4	10.07-06.15	ZJ-VE		EPBMWT5-A005D	93145		
1.4 MZR-CD	1399	50	4	01.08-06.15	Y404		EPBMWT4-A009H	92423		
1.5 MZR	1498	75	4	06.11-06.15	ZY05, ZY66		EPBMWT5-A014D	90205		
1.5	1498	76	4	07.07-06.15	ZY66		EPBMWT5-A014D	90205		
1.5	1498	83	4	10.07-06.15	ZY-VE		EPBMWT5-A005D	93145		
1.6 MZ-CD	1560	66	4	10.08-06.15	Y406, Y646		EPBMWT4-V003D	94395		
1.6 MZ-CD	1560	66	4	10.08-06.15	Y646, Y406		EPBMWT4-A009H	92423		
1.6 MZ-CD	1560	70	4	06.11-06.15	Y655, Y661		EPBMWT4-V003D	94395		
1.6 MZ-CD	1560	70	4	06.11-06.15	Y661, Y655		EPBMWT4-A009H	92423		

2 (DY) | DEMIO

1.4 CD	1399	50	4	04.03-06.07	F6JB		EPBMWT4-V003D	94395		
--------	------	----	---	-------------	------	--	---------------	-------	--	--

3 (BK)

1.3	1349	62	4	10.03-06.09	ZJ07, ZJ30		EPBMWT5-A014D	90205		
1.6 MZ-CD	1560	66	4	06.06-12.09	Y406		EPBMWT4-V003D	94395		
1.6 DI Turbo	1560	80	4	06.04-01.09	Y601		EPBMFT5-A001H	93740		
1.6	1598	77	4	02.04-06.09	Z601, Z627		EPBMWT5-A014D	90205		
2.0 MZR-CD	1998	105	4	07.06-06.09	RF7J, RF8G		EPBMWT5-A014D	90205		
2.0	1999	110	4	10.03-12.09	LF-DE, LF-VE, LF50, LF72, LFN7, LFN8		EPBMWT5-A014D	90205		

3 (BL)

1.6 MZR CD	1560	85	4	09.10-05.13	Y650, Y655		EPBMWT4-V003D	94395		
1.6 MZR	1598	77	4	12.08-09.14	Z668, Z682, Z683		EPBMWT5-A014D	90205		
1.6 MZR	1598	79	4	01.10-12.13	Z6		EPBMWT5-A014D	90205		
2.0 MZR	1999	108	4	04.09-09.14	LF5H		EPBMWT5-A014D	90205		
2.0 MZR	1999	110	4	01.09-09.14	LF5W		EPBMWT5-A014D	90205		
2.0 MZR	1999	110	4	03.09-09.14	LF5W, LF5H		EPBMWT5-A014D	90205		
2.0 MZR DISI	1999	111	4	12.08-05.13	LFZ2, LF5W		EPBMWT5-A014D	90205		
2.0 MZR DISI	1999	111	4	02.09-05.13	LFZ2		EPBMWT5-A014D	90205		
2.2 MZR CD	2184	110	4	01.09-09.14	R2AA		EPBMWT5-A014D	90205		
2.2 MZR CD	2184	136	4	01.09-05.13	R2AA		EPBMWT5-A014D	90205		
2.5	2488	122	4	03.09-09.14	L5-VE		EPBMWT5-A014D	90205		



MAF



l kW
C
Y
I



Type-N°

Stock-N°

Plug In
Alternative
Type-N°

Plug In
Subtype

MAZDA

3 (BM, BN)

1.6	1598	77	4	09.13-	Z6Y3, Z6Y1		EPBMWT5-A014D	90205		
-----	------	----	---	--------	------------	--	---------------	-------	--	--

323 S VI (BJ)

1.3	1324	53	4	01.01-05.04	B3		EPBMWT5-A014D	90205		
1.4	1324	53	4	01.01-05.04	B3		EPBMWT5-A014D	90205		
1.4 16V	1324	54	4	09.98-01.01	B3ME		EPBMWT5-A014D	90205		
1.5 16V	1498	65	4	09.98-01.01	ZL06, ZL05		EPBMWT5-A014D	90205		
1.6	1598	70	4	01.01-05.04	ZM		EPBMWT5-A014D	90205		
1.6	1598	72	4	01.01-05.04	ZM		EPBMWT5-A014D	90205		

5 (CR19)

1.8	1798	85	4	02.05-05.10	L823		EPBMWT5-A014D	90205		
2.0 CD	1998	81	4	02.05-05.10	RF7J		EPBMWT5-A014D	90205		
2.0 CD	1998	105	4	02.05-05.10	RF7J		EPBMWT5-A014D	90205		
2.0	1999	107	4	02.05-05.10	LFF7		EPBMWT5-A014D	90205		

5 (CW)

1.6 CD	1560	85	4	09.10-	Y650, Y655, Y6Y1		EPBMWT4-V003D	94395		
1.8 MZR	1798	85	4	09.10-	L850		EPBMWT5-A014D	90205		
2.0	1999	106	4	06.10-	LF-ZB		EPBMWT5-A014D	90205		
2.0	1999	108	4	01.11-	LF-ZB		EPBMWT5-A014D	90205		
2.0	1999	110	4	09.10-	LF-ZB		EPBMWT5-A014D	90205		

6 (GG)

1.8	1798	88	4	08.02-08.07	L813		EPBMWT5-A014D	90205		
2.0 DI	1998	89	4	08.02-08.07	RF5C		EPBMWT5-A014D	90205		
2.0 DI	1998	100	4	06.02-08.07	RF5C		EPBMWT5-A014D	90205		
2.0 DI	1998	105	4	06.05-08.07	RF7J		EPBMWT5-A014D	90205		
2.0	1999	104	4	06.02-08.07	LF17, LF18		EPBMWT5-A014D	90205		
2.0	1999	108	4	03.05-08.07	LFF7		EPBMWT5-A014D	90205		
2.3	2261	120	4	03.05-07.07	L3C1		EPBMWT5-A014D	90205		
2.3	2261	122	4	06.02-08.07	L3C1		EPBMWT5-A014D	90205		
2.3 MPS Turbo	2261	191	4	12.05-08.07	L3KG		EPBMWT5-A014D	90205		

6 (GH)

1.8 MZR	1798	88	4	02.08-07.13	L813		EPBMWT5-A014D	90205		
2.0 MZR-CD	1998	103	4	08.07-10.09	RF7J		EPBMWT5-A014D	90205		
2.0 MZR	1999	108	4	08.07-07.13	LF17, LF4J, LF4K, LFYA, LFYB		EPBMWT5-A014D	90205		
2.0 MZR	1999	114	4	01.10-07.13	LFDE		EPBMWT5-A014D	90205		
2.2 MZR-CD	2184	92	4	01.09-12.10	R2BF		EPBMWT5-A014D	90205		
2.2 D	2184	95	4	01.10-07.13	R2BF		EPBMWT5-A014D	90205		
2.2 MZR-CD	2184	120	4	01.09-12.12	R2AA		EPBMWT5-A014D	90205		
2.2 MZR-CD	2183	132	4	01.10-07.13	R2AA		EPBMWT5-A014D	90205		



MAF



l kW
C
Y
I



Type-Nº

Stock-Nº

Plug In
Alternative
Type-Nº

Plug In
Subtype

MAZDA

6 (GH)

2.2 MZR-CD	2184	136	4	01.09-12.12	R2AA		EPBMWT5-A014D	90205		
2.5 MZR	2488	125	4	02.08-07.13	L5-VE		EPBMWT5-A014D	90205		

6 STATION WAGON (GY)

1.8	1798	88	4	08.02-08.07	L813		EPBMWT5-A014D	90205		
2.0 DI	1998	89	4	08.02-08.07	RF5C		EPBMWT5-A014D	90205		
2.0 DI	1998	100	4	08.02-02.05	RF5C		EPBMWT5-A014D	90205		
2.0 DI	1998	105	4	06.05-08.07	RF7J		EPBMWT5-A014D	90205		
2.0	1999	104	4	08.02-08.07	LF17, LF18		EPBMWT5-A014D	90205		
2.0	1999	108	4	03.05-08.07	LFF7		EPBMWT5-A014D	90205		
2.3 AWD	2261	119	4	11.02-08.07	L3C1		EPBMWT5-A014D	90205		
2.3	2261	122	4	01.02-02.08	L3C1		EPBMWT5-A014D	90205		

626 V (GF, GW)

2.0 DI TD	1998	66	4	04.98-10.02	RF3F		EPBMWT5-A014D	90205		
2.0 Turbo DI	1998	74	4	04.98-10.02	RF4F		EPBMWT5-A014D	90205		
2.0 TD	1998	81	4	10.00-10.02	RF4F		EPBMWT5-A014D	90205		

B-SERIE (UN) | PROCEED / DRIFTER

2.5 D	2500	62	4	12.02-11.06	WLE7		EPBMWT5-A014D	90205		
2.5 D 4WD	2500	62	4	12.02-11.06	WLE7		EPBMWT5-A014D	90205		

BT-50 PICKUP (CD, UN)

2.5 MRZ-CD	2499	105	4	08.06-06.13	WLAA		EPBMWT5-A014D	90205		
2.5 MRZ-CD 4x4	2499	105	4	12.06-12.15	WLAA		EPBMWT5-A014D	90205		
3.0 CDVi	2953	115	4	12.06-12.15	WEAT		EPBMWT5-A014D	90205		
3.0 CDVi 4x4	2953	115	4	10.06-12.15	WEAT		EPBMWT5-A014D	90205		

CX-7 (ER)

2.2 MZR-CD AWD	2184	120	4	01.12-03.13	R2AA		EPBMWT5-A014D	90205		
2.2 MZR-CD AWD	2184	127	4	07.09-03.13	R2AA		EPBMWT5-A014D	90205		
2.5 MZR	2488	120	4	07.09-03.13	L5-VE		EPBMWT5-A014D	90205		

MPV II (LW)

2.0 DI	1998	100	4	07.02-02.06	RF5C		EPBMWT5-A014D	90205		
2.3	2261	104	4	07.02-02.06	L3		EPBMWT5-A014D	90205		

MX-5 III (NC)

1.8	1798	93	4	03.05-12.14	L828, L831		EPBMWT5-A014D	90205		
2.0	1999	118	4	07.05-12.14	LFG7, LFY7, LFG8		EPBMWT5-A014D	90205		

PREMACY (CP)

2.0 TD	1998	66	4	10.99-07.00	RF3F		EPBMWT5-A014D	90205		
2.0 TD	1998	74	4	07.00-03.05	RF4F		EPBMWT5-A014D	90205		

RX-8 (SE, FE)

1.3	1308	141	2	10.03-06.12	13B-MSP		EPBMWT5-A014D	90205		
1.3	1308	170	2	10.03-06.12	13B-MSP		EPBMWT5-A014D	90205		



MAF



l kW
C
Y
I



Type-N°

Stock-N°

Plug In
Alternative
Type-N°

Plug In
Stock-N°

MERCEDES-BENZ

124 (C124, W124, S124)

220	2199	110	4	10.92-05.93	M111960		EPBMFN4-D040H	96545		
-----	------	-----	---	-------------	---------	--	---------------	-------	--	--

A-CLASS (W168)

A 160 CDI	1689	44	4	07.98-02.01	OM668941		EPBMFN5-D004P	93343		
A 160 CDI	1689	55	4	02.01-08.04	OM668940		EPBMFN5-D004P	93343		
A 170 CDI	1689	66	4	07.98-02.01	OM668940		EPBMFN5-D004P	93343		
A 170 CDI	1689	70	4	02.01-08.04	OM668942		EPBMFN5-D004P	93343		

A-CLASS (W169)

A 160 CDI	1991	60	4	09.04-06.12	OM640942		EPBMFT4-D050H	94911		
A 180 CDI	1991	80	4	09.04-06.12	OM640940		EPBMFT4-D050H	94911		
A 200 CDI	1991	100	4	09.04-06.12	OM640941		EPBMFT4-D050H	94911		
A 200 CDI	1991	103	4	09.04-06.12	OM640941		EPBMFT4-D050H	94911		

B-CLASS SPORTS TOURER (W245)

B 180 CDI	1991	80	4	03.05-11.11	OM640940		EPBMFT4-D050H	94911		
B 200 CDI	1991	100	4	03.05-11.11	OM640941		EPBMFT4-D050H	94911		
B 200 CDI	1991	103	4	03.05-11.11	OM640941		EPBMFT4-D050H	94911		



C-CLASS (W202, S202)

C 180	1799	89	4	11.94-05.00	M111921		EPBMFT5-D009H	95803	EPBMFT5-D003P	96835
C 180	1799	90	4	03.93-05.00	M111920		EPBMFN4-D040H	96545	EPBMFT5-D003P	96835
C 180	1799	90	4	03.93-05.00	M111921		EPBMFT5-D009H	95803	EPBMFT5-D003P	96835
C 180	1998	95	4	09.00-03.01	M111952		EPBMWT5-D017H	94348		
C 200 CDI	2151	75	4	03.98-03.01	OM611960		EPBMFT5-D003P	96835		
C 200 CDI	2151	75	4	03.98-03.01	OM611960	; Engine-No.30055906	EPBMFT5-D009H	95803		
C 200	1998	100	4	01.94-05.00	M111941		EPBMFN4-D040H	96545	EPBMFT5-D003P	96835
C 200	1998	100	4	01.94-05.00	M111945		EPBMFT5-D009H	95803	EPBMFT5-D003P	96835
C 200 Kompressor	1998	120	4	09.00-03.01	M111956		EPBMWT5-D017H	94348		
C 200 Kompressor	1998	132	4	10.95-05.00	M111944		EPBMFT5-D009H	95803	EPBMFT5-D003P	96835
C 200 Kompressor	1998	141	4	11.96-03.01	M111944		EPBMFT5-D009H	95803	EPBMFT5-D003P	96835
C 220 CDI	2151	92	4	09.97-03.01	OM611960		EPBMFT5-D003P	96835		
C 220 CDI	2151	92	4	09.97-03.01	OM611960	; Engine-No.30055906	EPBMFT5-D009H	95803		
C 220	2199	110	4	03.93-05.00	M111961		EPBMFN4-D040H	96545		
C 230	2295	110	4	06.96-06.97	M111974		EPBMFT5-D009H	95803	EPBMFT5-D003P	96835
C 230 Kompressor	2295	142	4	10.95-05.00	M111975		EPBMFT5-D009H	95803	EPBMFT5-D003P	96835
C 230 Kompressor	2295	142	4	06.97-09.00	M111975		EPBMFN4-D040H	96545		
C 230 Kompressor	2295	142	4	06.97-09.00	M111975		EPBMFT5-D003P	96835		
C 240	2398	125	6	06.97-05.00	M112910		EPBMFT5-D025H	90977	EPBMFT5-D003P	96835
C 250 Turbo-D	2497	110	5	06.96-03.01	OM605960		EPBMFT5-D009H	95803	EPBMFT5-D003P	96835
C 280	2799	142	6	05.93-05.00	M104941	; EngineNo.>006909; EngineNo.>084643	EPBMFT5-D041H	97661	EPBMFT5-D003P	96835
C 280	2799	145	6	06.97-03.01	M112920		EPBMFT5-D025H	90977		





















MERCEDES-BENZ





C-CLASS (W202, S202)

C 36 AMG	3606	206	6	05.94-05.97	M104941	 ; EngineNo.>084643; EngineNo.>006909; 	EPBMFT5-D041H	97661	EPBMFT5-D003P	96835
C 43 AMG	4266	225	8	08.97-03.01	M113944		EPBMFT5-D047H	97067	EPBMFT5-D003P	96835

C-CLASS (W203, CL203, S203)

C 160 Kompressor	1796	90	4	05.02-05.08	M271921		EPBMWN5-D003H	92791		
C 180	1998	95	4	03.01-05.02	M111951		EPBMWT5-D017H	94348		
C 180 Kompressor	1796	105	4	06.02-02.07	M271946		EPBMWN5-D003H	92791		
C 200 CDI	2148	75	4	03.01-08.07	OM611962, OM646962		EPBMFT5-D018H	96224		
C 200 CDI	2148	90	4	04.03-02.07	OM646963, OM646962		EPBMFT5-D018H	96224	EPBMFT5-D003P	96835
C 200 Kompressor	1998	120	4	03.01-05.02	M111955		EPBMWT5-D017H	94348		
C 200 Kompressor	1796	120	4	06.02-02.07	M271940		EPBMWN5-D003H	92791		
C 200 CGI Kompressor	1796	125	4	07.03-02.07	M271942		EPBMWN5-D003H	92791		
C 220 CDI	2148	105	4	03.01-12.02	OM611962, OM646963		EPBMFN5-D004P	93343		
C 220 CDI	2148	105	4	03.01-01.04	OM611962		EPBMFT5-D018H	96224		
C 220 CDI	2148	110	4	02.03-02.07	OM646963		EPBMFT5-D018H	96224	EPBMFT5-D003P	96835
C 220	1796	120	4	05.02-05.08	M271940		EPBMWN5-D003H	92791		
C 230 Kompressor	1796	141	4	02.04-02.07	M271948		EPBMWN5-D003H	92791		
C 230 Kompressor	2295	145	4	05.01-05.02	M111981		EPBMWT5-D017H	94348		
C 230	2496	150	6	01.05-02.07	M272920		EPBMFT5-V027H	94616		
C 240	2597	125	6	03.01-08.07	M112912		EPBMFT5-D025H	90977	EPBMFT5-D003P	96835
C 240 4-matic	2597	125	6	07.02-02.07	M112916		EPBMFT5-D025H	90977		
C 270 CDI	2685	125	5	03.01-08.07	OM612962		EPBMFN5-D004P	93343		
C 280	2996	170	6	01.05-02.07	M272940		EPBMFT5-V027H	94616		
C 280 4-matic	2996	170	6	01.05-02.07	M272941		EPBMFT5-V027H	94616		
C 30 CDI AMG	2950	170	5	01.03-02.07	OM612990		EPBMFT5-D018H	96224		
C 320	3199	160	6	03.01-05.08	M112946		EPBMFT5-D025H	90977	EPBMFT5-D003P	96835
C 320 4-matic	3199	160	6	07.02-02.07	M112953		EPBMFT5-D025H	90977		
C 32 AMG Kompressor	3199	260	6	02.01-02.07	M112961		EPBMFT5-D025H	90977		
C 350	3498	200	6	01.05-02.07	M272960		EPBMFT5-V027H	94616		
C 350 4-matic	3498	200	6	01.05-02.07	M272970		EPBMFT5-V027H	94616		
C 55 AMG	5439	270	8	02.04-02.07	M113988		EPBMFT5-D043H	90272		

C-CLASS (W204, S204)

C 180 Kompressor	1597	115	4	01.08-01.14	M271910		EPBMWN5-D003H	92791		
C 180 Kompressor	1796	115	4	01.07-01.14	M271952		EPBMWN5-D003H	92791		
C 200 Kompressor	1796	135	4	01.07-01.14	M271950		EPBMWN5-D003H	92791		
C 200 CDI	2148	100	4	01.07-12.09	OM646811, OM646812		EPBMFT5-D018H	96224	EPBMFT5-D003P	96835
C 220 CDI	2148	120	4	01.07-11.08	OM646811		EPBMFT5-D018H	96224		
C 220 CDI	2148	125	4	01.07-11.08	OM646811		EPBMFT5-D018H	96224		
C 230	2496	150	6	01.07-01.14	M272921		EPBMFT5-V027H	94616		

MAF



l kW
C
Y
I



Type-N°

Stock-N°

Plug In
Alternative
Type-N°

Plug In
Stöcke

MERCEDES-BENZ

C-CLASS (W204, S204)

C 230 4-matic	2496	150	6	07.07-01.14	M272911		EPBMFT5-V027H	94616		
C 250	2496	150	6	02.08-12.12	M272921		EPBMFT5-V027H	94616		
C 280	2996	170	6	01.07-01.14	M272947		EPBMFT5-V027H	94616		
C 280 4-matic	2996	170	6	07.07-01.14	M272948		EPBMFT5-V027H	94616		
C 300 4-matic	2996	170	6	07.07-01.14	M272948		EPBMFT5-V027H	94616		
C 300	2996	170	6	07.09-01.14	M272947		EPBMFT5-V027H	94616		
C 350	3498	200	6	01.07-01.14	M272961		EPBMFT5-V027H	94616		
C 350 4-matic	3498	200	6	07.07-01.14	M272971		EPBMFT5-V027H	94616		
C 350 CGI	3498	215	6	09.08-01.14	M272982		EPBMFT5-V027H	94616		

CITAN (415)

111 CDI	1461	81	4	06.13-	OM607951	; Type:415601	EPBMWT4-A019H	94808		
---------	------	----	---	--------	----------	---------------	---------------	-------	--	--

CLC-CLASS (CL203)

CLC 160	1597	95	4	02.09-06.11	M271911		EPBMWN5-D003H	92791		
CLC 180 Kompressor	1796	105	4	05.08-06.11	M271946		EPBMWN5-D003H	92791		
CLC 200 Kompressor	1796	135	4	05.08-06.11	M271957		EPBMWN5-D003H	92791		
CLC 200 CDI	2148	90	4	05.08-06.11	OM646962		EPBMFT5-D018H	96224		
CLC 220 CDI	2148	110	4	05.08-06.11	OM646963		EPBMFT5-D018H	96224		
CLC 230	2496	150	6	05.08-06.11	M272920		EPBMFT5-V027H	94616		
CLC 250	2496	150	6	06.09-06.11	M272920		EPBMFT5-V027H	94616		
CLC 350	3498	200	6	05.08-06.11	M272960		EPBMFT5-V027H	94616		

CLK (A208, C208)

200	1998	100	4	06.97-06.00	M111945		EPBMFT5-D009H	95803	EPBMFT5-D003P	96835
200	1998	100	4	03.98-06.00	M111945		EPBMFT5-D003P	96835		
200 Kompressor	1998	120	4	06.00-03.02	M111956		EPBMWT5-D017H	94348	EPBMFT5-D003P	96835
200 Kompressor	1998	141	4	06.97-06.00	M111944		EPBMFT5-D009H	95803	EPBMFT5-D003P	96835
230 Kompressor	2295	142	4	06.97-06.00	M111975		EPBMFT5-D009H	95803	EPBMFT5-D003P	96835
230 Kompressor	2295	145	4	06.00-06.02	M111982	; Chass.<T054271; Chass.>T000730; Chass.>F136789	EPBMFT5-D009H	95803		
230 Kompressor	2295	145	4	06.00-05.02	M111982	; Chass.>T054272; Chass.>T000730; Chass.>F136790	EPBMWT5-D017H	94348		
320	3199	160	6	06.97-06.02	M112940	; Chass.>T102653; Chass.>F198564	EPBMFT5-D025H	90977	EPBMFT5-D003P	96835
430	4266	205	8	07.98-06.02	M113943		EPBMFT5-D043H	90272	EPBMFT5-D003P	96835
55 AMG	5439	255	8	08.99-06.02	M113981, M113984		EPBMFT5-D043H	90272		
55 AMG	5439	255	8	08.99-06.02	M113984	; for SA code:918	EPBMFT5-D047H	97067		

CLK (A209, C209)

200 Kompressor	1796	120	4	09.02-05.09	M271940		EPBMWN5-D003H	92791		
200 CGI	1796	125	4	07.03-05.09	M271942		EPBMWN5-D003H	92791		
200 Kompressor	1796	135	4	10.06-05.09	M271955		EPBMWN5-D003H	92791		
220 CDI	2148	100	4	01.05-05.09	OM646966		EPBMFT5-D018H	96224		





Type-N°

Stock-N°

Plug In
Alternative
Type-N°

Plug In
Subtype

MERCEDES-BENZ

CLK (A209, C209)

220 CDI	2148	110	4	01.05-05.09	OM646966		EPBMFT5-D018H	96224		
240	2597	120	6	06.02-05.09	M112912		EPBMFT5-D025H	90977		
240	2597	125	6	06.02-05.09	M112912	; Chass.>F000107	EPBMFT5-D025H	90977	EPBMFT5-D003P	96835
270 CDI	2685	125	5	10.02-05.09	OM612962, OM612967		EPBMFN5-D004P	93343		
280	2996	170	6	01.05-05.09	M272940		EPBMFT5-V027H	94616		
320	3199	160	6	06.02-05.09	M112955		EPBMFT5-D025H	90977		
350	3498	200	6	01.05-05.09	M272960		EPBMFT5-V027H	94616		
500	4966	225	8	06.02-05.09	M113968		EPBMFT5-D043H	90272		
55 AMG	5439	270	8	09.02-05.09	M113987		EPBMFT5-D043H	90272		
CLK 500	5461	285	8	06.06-03.10	M273967		EPBMFT5-V027H	94616		

CLS (C219)

CLS 280	2996	170	6	07.08-12.10	M272943		EPBMFT5-V027H	94616		
CLS 300	2996	170	6	04.09-12.10	M272943		EPBMFT5-V027H	94616		
CLS 350	3498	200	6	10.04-12.10	M272964		EPBMFT5-V027H	94616		
CLS 350	3498	215	6	04.06-12.10	M272985		EPBMFT5-V027H	94616		
CLS 500	5461	285	8	04.06-12.10	M273960		EPBMFT5-V027H	94616		

E-CLASS (A124, C124, W124)

E 220	2199	110	4	06.93-06.95	M111960		EPBMFN4-D040H	96545		
-------	------	-----	---	-------------	---------	--	---------------	-------	--	--

E-CLASS (A207, C207)

E 350	3498	200	6	03.10-12.11	M272961, M272988		EPBMFT5-V027H	94616		
E 350 CGI	3498	215	6	01.10-12.14	M272984, M272982		EPBMFT5-V027H	94616		
E 500	5461	285	8	01.10-12.11	M273966		EPBMFT5-V027H	94616		

E-CLASS (W210, S210)

E 200 CDI	2151	75	4	06.98-08.99	OM611961		EPBMFN5-D004P	93343		
E 200 CDI	2151	75	4	06.98-08.99	OM611961		EPBMFT5-D003P	96835		
E 200 CDI	2148	85	4	07.99-08.99	OM611961		EPBMFN5-D004P	93343		
E 200 CDI	2148	85	4	07.99-08.99	OM611961		EPBMFT5-D003P	96835		
E 200	1998	100	4	06.95-09.96	M111942		EPBMFN4-D040H	96545		
E 200	1998	100	4	10.96-08.00	M111942		EPBMFT5-D009H	95803	EPBMFT5-D003P	96835
E 200 Kompressor	1998	120	4	08.00-03.02	M111957		EPBMWT5-D017H	94348		
E 200 Kompressor	1998	137	4	06.97-03.02	M111947		EPBMFT5-D009H	95803	EPBMFT5-D003P	96835
E 220 CDI	2151	92	4	06.98-07.99	OM611961		EPBMFN5-D004P	93343		
E 220 CDI	2151	92	4	06.98-07.99	OM611961		EPBMFT5-D003P	96835		
E 220 CDI	2148	100	4	05.99-03.03	OM611961		EPBMFN5-D004P	93343		
E 220 CDI	2148	105	4	07.99-08.99	OM611961		EPBMFN5-D004P	93343		
E 220 CDI	2148	105	4	07.99-08.99	OM611961		EPBMFT5-D003P	96835		
E 230	2295	110	4	06.95-06.97	M111970	EngineNo.l	EPBMFN4-D040H	96545		
E 230	2295	110	4	06.95-06.97	M111970	; EngineNo.>042471; EngineNo.>013234;	EPBMFT5-D009H	95803	EPBMFT5-D003P	96835
E 230	2295	110	4	06.96-06.97	M111970	EngineNo.l	EPBMFN4-D040H	96545		

MAF



l kW
C
Y
I



Type-N°

Stock-N°

Plug In
Alternative
Type-N°

Plug In
Stock-N°

MERCEDES-BENZ

E-CLASS (W210, S210)

E 230	2295	110	4	06.96-06.97	M111970	; EngineNo.>042471; 	EPBMFT5-D009H	95803	EPBMFT5-D003P	96835
E 240	2398	125	6	06.97-03.03	M112911		EPBMFT5-D025H	90977		
E 240	2597	125	6	08.00-03.02	M112914		EPBMFT5-D025H	90977	EPBMFT5-D003P	96835
E 280	2799	150	6	12.96-03.02	M112921	; Chass.>X065665; Chass.>B438527	EPBMFT5-D025H	90977	EPBMFT5-D003P	96835
E 280 4-matic	2799	150	6	12.96-03.02	M112921	; Chass.>X065665; Chass.>B438527	EPBMFT5-D025H	90977	EPBMFT5-D003P	96835
E 300 Turbo-D	2996	130	6	12.96-07.99	OM606962		EPBMFN5-D004P	93343		
E 300 Turbo-D	2996	130	6	12.96-07.99	OM606962		EPBMFT5-D003P	96835		
E 320	3199	162	6	06.95-06.97	M104995	; EngineNo.>050174	EPBMFT5-D003P	96835		
E 320	3199	165	6	06.97-03.02	M112941		EPBMFT5-D025H	90977	EPBMFT5-D003P	96835
E 320 4-matic	3199	165	6	06.97-03.02	M112941		EPBMFT5-D025H	90977	EPBMFT5-D003P	96835
E 320 CDI	3222	145	6	07.99-03.02	OM613961		EPBMFN5-D004P	93343		
E 320 CDI	3226	145	6	07.99-03.03	OM613961		EPBMFN5-D004P	93343		
E 430	4266	205	8	06.97-03.03	M113940		EPBMFT5-D043H	90272	EPBMFT5-D003P	96835
E 430	4266	205	8	06.97-03.02	M113940	; Euro2	EPBMFT5-D047H	97067		
E 430 4-matic	4266	205	8	05.99-03.02	M113940		EPBMFT5-D043H	90272	EPBMFT5-D003P	96835
E 430 4-matic	4266	205	8	05.99-03.02	M113940	; Euro2	EPBMFT5-D047H	97067		
E 55 AMG	5439	260	8	08.97-03.02	M113980	; Euro2	EPBMFT5-D047H	97067		

E-CLASS (W211, S211)

E 200 CDI	2148	75	4	07.02-12.08	OM646951		EPBMFT5-D018H	96224		
E 200 CDI	2148	90	4	07.02-12.08	OM646951		EPBMFT5-D018H	96224		
E 200 Kompressor	1796	120	4	03.03-07.09	M271941		EPBMWN5-D003H	92791		
E 200 NG	1796	120	4	03.04-12.08	M271941		EPBMWN5-D003H	92791		
E 200 Kompressor	1796	135	4	04.06-07.09	M271956		EPBMWN5-D003H	92791		
E 220 CDI	2148	100	4	03.02-12.08	OM646961		EPBMFT5-D018H	96224		
E 200 CDI	2148	100	4	04.06-07.09	OM646820		EPBMFT5-D018H	96224		
E 220 CDI	2148	110	4	03.02-12.08	OM646961		EPBMFT5-D018H	96224	EPBMFT5-D003P	96835
E 220 CDI	2148	120	4	03.03-07.09	OM646821		EPBMFT5-D018H	96224		
E 220 CDI	2149	120	4	03.03-12.08	OM646821		EPBMFT5-D018H	96224		
E 220 CDI	2148	125	4	04.06-07.09	OM646821		EPBMFT5-D018H	96224		
E 230	2496	150	6	05.07-07.09	M272922		EPBMFT5-V027H	94616		
E 240	2597	130	6	03.02-12.08	M112913		EPBMFT5-D025H	90977	EPBMFT5-D003P	96835
E 240 4-matic	2597	130	6	03.03-12.08	M112917		EPBMFT5-D025H	90977		
E 270 CDI	2685	120	5	03.02-12.08	OM647961		EPBMFT5-D018H	96224		
E 270 CDI	2685	130	5	03.02-12.08	OM647961		EPBMFT5-D018H	96224	EPBMFT5-D003P	96835
E 280 CDI	3222	130	6	05.04-07.09	OM648961		EPBMFT5-D018H	96224		
E 280	2996	170	6	03.05-07.09	M272943		EPBMFT5-V027H	94616		
E 280 4-matic	2996	170	6	01.06-12.08	M272944		EPBMFT5-V027H	94616		





Type-Nº

Stock-Nº

Plug In
Alternative
Type-Nº

Plug In
Subtype

MERCEDES-BENZ

E-CLASS (W211, S211)

E 320 CDI	3222	150	6	03.03-07.09	OM648961		EPBMFT5-D018H	96224	EPBMFT5-D003P	96835
E 320	3199	165	6	03.02-12.08	M112949		EPBMFT5-D043H	90272		
E 320	3199	165	6	03.02-12.08	M112949		EPBMFT5-D025H	90977		
E 320 4-matic	3199	165	6	03.03-12.08	M112954		EPBMFT5-D043H	90272		
E 320 4-matic	3199	165	6	03.03-12.08	M112954		EPBMFT5-D025H	90977		
E 350	3498	200	6	03.05-07.09	M272964		EPBMFT5-V027H	94616		
E 350 4-matic	3498	200	6	03.05-07.09	M272972		EPBMFT5-V027H	94616		
350 CGI	3498	215	6	05.06-07.09	M272985		EPBMFT5-V027H	94616		
E 350 CGI	3498	215	6	09.07-12.08	M272985		EPBMFT5-V027H	94616		
E 500	4966	225	8	03.02-12.08	M113967		EPBMFT5-D043H	90272		
E 500 4-matic	4966	225	8	10.03-07.09	M113969		EPBMFT5-D043H	90272		
E 500	5461	285	8	04.06-07.09	M273960		EPBMFT5-V027H	94616		
E 500 4-matic	5461	285	8	04.06-07.09	M273962		EPBMFT5-V027H	94616		
E 55 AMG Kompressor	5439	350	8	07.03-07.09	M113990		EPBMFT5-D043H	90272		

E-CLASS (W212, S212)

E 200 NG	1796	120	4	03.11-12.15	M271958		EPBMWN5-D003H	92791		
E 300	2996	170	6	01.09-12.13	M272952		EPBMFT5-V027H	94616		
E 350	3498	200	6	01.09-12.13	M272980		EPBMFT5-V027H	94616		
E 350 4-matic	3498	200	6	01.09-08.11	M272977		EPBMFT5-V027H	94616		
E 350 CGI	3498	215	6	01.09-08.11	M272983		EPBMFT5-V027H	94616		
E 500	5461	285	8	01.09-12.11	M273971		EPBMFT5-V027H	94616		
E 500 4-matic	5461	285	8	01.09-12.11	M273970		EPBMFT5-V027H	94616		

G-CLASS (W463)

G 320	3199	158	6	07.97-	M112945		EPBMFT5-D043H	90272		
G 320	3199	158	6	11.97-	M112945		EPBMFT5-D025H	90977		
G 500	4966	218	8	04.98-	M113962		EPBMFT5-D043H	90272		
G 500	4966	218	8	04.98-	M113962		EPBMFT5-D047H	97067		
G 500	5461	285	8	05.08-	M273963		EPBMFT5-V027H	94616		

GL-CLASS (X164)

GL 450 4-matic	4663	250	8	09.06-08.12	M273923		EPBMFT5-V027H	94616		
GL 500 4-matic	5461	285	8	09.06-12.12	M273963		EPBMFT5-V027H	94616		

GLK-CLASS (X204)

280 4-matic	2996	170	6	06.08-06.09	M272948		EPBMFT5-V027H	94616		
300 4-matic	2996	170	6	07.09-12.15	M272948		EPBMFT5-V027H	94616		
350 4-matic	3498	200	6	06.08-04.11	M272971		EPBMFT5-V027H	94616		
350	3498	200	6	04.09-06.15	M272991		EPBMFT5-V027H	94616		

M-CLASS (W163)

ML 230	2295	110	4	02.98-06.05	M111977		EPBMFT5-D009H	95803	EPBMFT5-D003P	96835
ML 270 CDI	2685	120	5	12.99-06.05	OM612963		EPBMFN5-D004P	93343		

MAF



l kW
C
Y
I



Type-N°

Stock-N°

Plug In
Alternative
Type-N°

Plug In
Stock-N°

MERCEDES-BENZ

M-CLASS (W163)

ML 320	3199	160	6	02.98-08.02	M112942		EPBMFT5-D025H	90977	EPBMFT5-D003P	96835
ML 350	3724	173	6	02.03-06.05	M112970		EPBMFT5-D025H	90977		
ML 350	3724	180	6	08.02-06.05	M112970		EPBMFT5-D025H	90977		
ML 430	4266	200	8	02.98-06.05	M113942		EPBMFT5-D043H	90272	EPBMFT5-D003P	96835
ML 500	4966	215	8	09.01-06.05	M113965		EPBMFT5-D043H	90272	EPBMFT5-D003P	96835

M-CLASS (W164)

ML 300 4-matic	2996	170	6	03.10-12.11	M272945		EPBMFT5-V027H	94616		
ML 350 4-matic	3498	200	6	02.05-12.11	M272967		EPBMFT5-V027H	94616		
ML 500 4-matic	4966	225	8	07.05-12.11	M113964		EPBMFT5-D043H	90272		
ML 500 4-matic	5461	285	8	12.07-12.11	M273963		EPBMFT5-V027H	94616		

R-CLASS (W251, V251)

R 280	2996	170	6	01.07-12.14	M272945		EPBMFT5-V027H	94616		
R 280 4-matic	2996	170	6	05.07-12.11	M272945		EPBMFT5-V027H	94616		
R 300	2996	170	6	07.09-12.14	M272945		EPBMFT5-V027H	94616		
R 350 4-matic	3498	200	6	08.05-12.12	M272967		EPBMFT5-V027H	94616		
R 350	3498	200	6	01.07-12.12	M272967		EPBMFT5-V027H	94616		
R 500 4-matic	4966	225	8	08.05-12.14	M113960, M113971		EPBMFT5-D043H	90272		
R 500 4-matic	5461	285	8	05.07-12.14	M273963		EPBMFT5-V027H	94616		

S-CLASS (W140)

S 280	2799	142	6	02.93-10.98	M104944	; EngineNo.>017173; EngineNo.>001152; 	EPBMFT5-D041H	97661	EPBMFT5-D003P	96835
300 SE 2.8	2799	145	6	01.93-05.93	M104944	; EngineNo.>017173; EngineNo.>001152; 	EPBMFT5-D041H	97661	EPBMFT5-D003P	96835
300 SE, SEL/S320	3199	170	6	03.91-10.98	M104990, M104994	; EngineNo.>073223	EPBMFT5-D041H	97661	EPBMFT5-D003P	96835

S-CLASS (W220, S221)

S 280	2799	150	6	10.98-08.05	M112922		EPBMFT5-D025H	90977	EPBMFT5-D003P	96835
S 280	2996	170	6	08.06-12.13	M272946		EPBMFT5-V027H	94616		
S 300	2996	170	6	08.06-12.13	M272946		EPBMFT5-V027H	94616		
S 320	3199	165	6	10.98-08.05	M112944		EPBMFT5-D025H	90977	EPBMFT5-D003P	96835
S 320 CDI	3222	145	6	08.99-09.02	OM613960		EPBMFN5-D004P	93343		
S 320 CDI	3222	150	6	09.02-08.05	OM648960		EPBMFT5-D018H	96224	EPBMFT5-D003P	96835
S 350	3498	200	6	10.05-12.13	M272965		EPBMFT5-V027H	94616		
S 350 4-matic	3498	200	6	02.08-12.13	M272975		EPBMFT5-V027H	94616		
S 400 Hybrid	3498	205	6	01.09-12.13	M272974		EPBMFT5-V027H	94616		
S 350	3724	180	6	09.02-08.05	M112972		EPBMFT5-D025H	90977		
S 350 4-matic	3724	180	6	06.03-08.05	M112975		EPBMFT5-D025H	90977		
S 430	4266	205	8	10.98-08.05	M113941		EPBMFT5-D043H	90272	EPBMFT5-D003P	96835
S 430 4-matic	4266	205	8	09.02-08.05	M113948		EPBMFT5-D043H	90272		





Type-Nº

Stock-Nº

Plug In Alternative Type-Nº

Plug In Stock-Nº

MERCEDES-BENZ

S-CLASS (W220, S221)

S 450	4663	250	8	12.05-12.13	M273922		EPBMFT5-V027H	94616		
S 450 4-matic	4663	250	8	12.05-12.13	M273924		EPBMFT5-V027H	94616		
S 500	4966	220	8	10.98-12.03	M113960		EPBMFT5-D043H	90272		
S 500	4966	220	8	10.98-12.03	M113960	; for SA code:918	EPBMFT5-D047H	97067		
S 500	4966	225	8	10.98-08.05	M113960, M113966		EPBMFT5-D043H	90272	EPBMFT5-D003P	96835
S 500 4-matic	4966	225	8	09.02-08.05	M113966		EPBMFT5-D043H	90272		
S 55 AMG Kompressor	5439	368	8	06.02-08.05	M113991		EPBMFT5-D043H	90272		
S 500	5461	285	8	10.05-12.13	M273961		EPBMFT5-V027H	94616		
S 500 4-matic	5461	285	8	10.05-12.13	M273968		EPBMFT5-V027H	94616		
S 600	5786	270	12	01.00-08.05	M137970		EPBMFT5-D043H	90272		

S-CLASS COUPE (C215)

CL 500	4966	225	8	03.99-03.06	M113960		EPBMFT5-D043H	90272		
CL 500	4966	225	8	03.99-03.06	M113960	; for SA code:918	EPBMFT5-D047H	97067		
CL 55 AMG	5439	265	8	10.99-03.06	M113986		EPBMFT5-D043H	90272		
CL 600	5786	270	12	03.99-03.06	M137970		EPBMFT5-D043H	90272		

S-CLASS COUPE (C216)

CL 500	5461	285	8	06.06-12.13	M273961		EPBMFT5-V027H	94616		
CL 500 4-matic	5461	285	8	02.08-12.13	M273968		EPBMFT5-V027H	94616		

SL (R129)

280	2799	142	6	08.93-06.98	M104943	; EngineNo.>006578; EngineNo.>001546; 	EPBMFT5-D041H	97661	EPBMFT5-D003P	96835
280	2799	150	6	05.98-10.01	M112923		EPBMFT5-D025H	90977	EPBMFT5-D003P	96835
320	3199	165	6	05.98-10.01	M112943		EPBMFT5-D025H	90977		
320	3199	170	6	09.93-05.98	M104991	; EngineNo.>022858	EPBMFT5-D041H	97661	EPBMFT5-D003P	96835
500	4966	225	8	05.98-10.01	M113961		EPBMFT5-D047H	97067		

SL (R230)

280	2996	170	6	03.08-01.12	M272949		EPBMFT5-V027H	94616		
300	2996	170	6	04.09-01.12	M272949		EPBMFT5-V027H	94616		
350	3498	200	6	03.06-01.12	M272966		EPBMFT5-V027H	94616		
350	3498	232	6	04.08-01.12	M272968		EPBMFT5-V027H	94616		
350	3724	180	6	03.03-01.12	M112973		EPBMFT5-D025H	90977		
500	4966	225	8	10.01-01.12	M113963		EPBMFT5-D043H	90272		
500	5461	285	8	03.06-01.12	M273965		EPBMFT5-V027H	94616		

SLK (R170)

200	1998	100	4	09.96-03.00	M111946		EPBMFT5-D009H	95803	EPBMFT5-D003P	96835
200 Kompressor	1998	120	4	03.00-04.04	M111958		EPBMFT5-D017H	94348		
200 Kompressor	1998	141	4	10.96-03.00	M111943		EPBMFT5-D009H	95803	EPBMFT5-D003P	96835
230 Kompressor	2295	142	4	09.96-03.00	M111973		EPBMFT5-D009H	95803	EPBMFT5-D003P	96835

MAF



l kW
C
Y
I



Type-N°

Stock-N°

Plug In
Alternative
Type-N°

Plug In
Stock-N°

MERCEDES-BENZ

SLK (R170)

230 Kompressor	2295	145	4	03.00-04.04	M111983		EPBMWT5-D017H	94348		
320	3199	160	6	03.00-04.04	M112947		EPBMFT5-D025H	90977	EPBMFT5-D003P	96835
32 AMG Kompressor	3199	260	6	03.01-04.04	M112960		EPBMFT5-D025H	90977		

SLK (R171)

200 Kompressor	1795	120	4	03.04-02.11	M271944		EPBMWN5-D003H	92791		
200 Kompressor	1796	135	4	01.08-02.11	M271954		EPBMWN5-D003H	92791		
280	2996	170	6	01.05-02.11	M272942		EPBMFT5-V027H	94616		
300	2996	170	6	04.09-02.11	M272942		EPBMFT5-V027H	94616		
350	3498	200	6	06.04-02.11	M272963		EPBMFT5-V027H	94616		
350	3498	224	6	01.08-02.11	M272969		EPBMFT5-V027H	94616		
55 AMG	5439	265	8	06.04-02.11	M113989		EPBMFT5-D043H	90272		
55 AMG	5439	294	8	06.06-02.11	M113989		EPBMFT5-D043H	90272		

SPRINTER (901, 902)

208 CDI	2148	60	4	04.00-05.06	OM611987		EPBMFT5-D041H	97661		
211 CDI	2148	80	4	04.00-05.06	OM611981		EPBMFT5-D041H	97661		
213 CDI	2148	95	4	04.00-05.06	OM611981		EPBMFT5-D041H	97661		
214	2295	105	4	02.95-03.00	M111979, M111984		EPBMFT5-D009H	95803	EPBMFT5-D003P	96835
216 CDI	2685	115	5	04.00-05.06	OM612981		EPBMFT5-D041H	97661		

SPRINTER (903)

308 CDI	2148	60	4	04.00-05.06	OM611987		EPBMFT5-D041H	97661		
311 CDI	2148	80	4	04.00-05.06	OM611981		EPBMFT5-D041H	97661		
311 CDI 4x4	2148	80	4	08.02-05.06	OM611981		EPBMFT5-D041H	97661		
313 CDI	2148	95	4	04.00-05.06	OM611981		EPBMFT5-D041H	97661		
313 CDI 4x4	2148	95	4	08.02-05.06	OM611981		EPBMFT5-D041H	97661		
314	2295	105	4	02.95-05.06	M111979, M111984		EPBMFT5-D009H	95803	EPBMFT5-D003P	96835
314 4x4	2295	105	4	08.02-05.06	M111984		EPBMFT5-D009H	95803	EPBMFT5-D003P	96835
316 CDI	2685	115	5	04.00-05.06	OM612981, OM647981		EPBMFT5-D041H	97661		
316 CDI 4x4	2685	115	5	08.02-05.06	OM612981, OM647981		EPBMFT5-D041H	97661		

SPRINTER (904)

408 CDI	2148	60	4	04.00-05.06	OM611987		EPBMFT5-D041H	97661		
411 CDI	2148	80	4	04.00-05.06	OM611981		EPBMFT5-D041H	97661		
411 CDI 4x4	2148	80	4	04.00-05.06	OM611981		EPBMFT5-D041H	97661		
413 CDI	2148	95	4	04.00-05.06	OM611981		EPBMFT5-D041H	97661		
413 CDI 4x4	2148	95	4	04.00-05.06	OM611981		EPBMFT5-D041H	97661		
414	2295	105	4	02.95-03.00	M111979, M111984		EPBMFT5-D009H	95803	EPBMFT5-D003P	96835
414 4x4	2295	105	4	05.97-03.00	M111979, M111984		EPBMFT5-D009H	95803	EPBMFT5-D003P	96835
416 CDI	2685	115	5	04.00-05.06	OM612981, OM647981		EPBMFT5-D041H	97661		
416 CDI 4x4	2685	115	5	04.00-05.06	OM612981, OM647981		EPBMFT5-D041H	97661		





Type-Nº

Stock-Nº

Plug In
Alternative
Type-Nº



Plug In
Subtype

MERCEDES-BENZ

SPRINTER (905)

616 CDI	2685	115	5	04.01-	OM612981		EPBMFT5-D041H	97661		
----------------	------	-----	---	--------	----------	---	----------------------	--------------	--	--

SPRINTER (906)

213 CDI	2143	95	4	06.06-	OM651957, OM651955		EPBMFN4-D014H	92888		
216	1796	115	4	09.08-	M271951		EPBMWN5-D003H	92791		
216 CDI	2143	120	4	03.09-	OM651957, OM651955		EPBMFN4-D014H	92888		
219 CDI / BlueTEC	2987	140	6	03.09-	OM642992, OM642896		EPBMFN4-D014H	92888		
224	3498	190	6	06.06-	M272979		EPBMFT5-V027H	94616		
311 CDI 4x4	2148	80	4	02.08-12.09	OM646985		EPBMFN4-D014H	92888		
313 CDI	2143	95	4	08.11-05.16	OM651955	Euro3	EPBMFN4-D014H	92888		
313 CDI 4x4	2143	95	4	08.11-05.16	OM651955	Euro3	EPBMFN4-D014H	92888		
316	1796	115	4	09.08-	M271951		EPBMWN5-D003H	92791		
316 LGT	1796	115	4	09.08-	M271951		EPBMWN5-D003H	92791		
316 NGT	1796	115	4	09.08-	M271951		EPBMWN5-D003H	92791		
318 CDI	2987	135	6	02.08-12.09	OM642992, OM642993, OM642896, OM642986		EPBMFN4-D014H	92888		
318 CDI 4x4	2987	135	6	02.08-12.09	OM642992, OM642993, OM642896, OM642986		EPBMFN4-D014H	92888		
319 CDI / BlueTEC	2987	140	6	03.09-	OM642992, OM642896, OM642898, OM642986		EPBMFN4-D014H	92888		
319 CDI / BlueTEC 4x4	2987	140	6	03.09-	OM642992, OM642896, OM642898, OM642986	Type:906733	EPBMFN4-D014H	92888		
324	3498	190	6	06.06-12.13	M272979		EPBMFT5-V027H	94616		
411 CDI	2148	80	4	06.09-12.18	OM646985	for SA code:MC2; Not for SA code MS3	EPBMFN4-D014H	92888		
415 CDI	2148	110	4	06.06-12.09	OM646990, OM646986, OM646989	for SA code:MC3	EPBMFN4-D014H	92888		
418 CDI	2987	135	6	06.06-12.09	OM642992, OM642993, OM642896, OM642986	for SA code:MC1, MC2, MC3, MC4; Not for SA code MS3	EPBMFN4-D014H	92888		
419 CDI	2987	140	6	03.09-	OM642992, OM642896, OM642898, OM642986		EPBMFN4-D014H	92888		
424	3498	190	6	06.06-12.13	M272979		EPBMFT5-V027H	94616		
511 CDI 4x4	2148	80	4	06.06-12.09	OM646985		EPBMFN4-D014H	92888		
515 CDI	2148	110	4	06.06-12.09	OM646986, OM646989, OM646990	Type:906655, 906657	EPBMFN4-D014H	92888		
515 CDI 4x4	2148	110	4	06.06-12.09	OM646990, OM646986, OM646989		EPBMFN4-D014H	92888		
516	1796	115	4	09.08-	M271951		EPBMWN5-D003H	92791		
516 NGT	1796	115	4	09.08-	M271951		EPBMWN5-D003H	92791		
518 CDI 4x4	2987	135	6	06.06-12.09	OM642992, OM642993, OM642896, OM642986		EPBMFN4-D014H	92888		
519 CDI / BlueTEC	2987	140	6	03.09-	OM642992, OM642896, OM642898		EPBMFN4-D014H	92888		

MAF



l kW
C
Y
I



Type-N°

Stock-N°

Plug In
Alternative
Type-N°

Plug In
Stock-N°

MERCEDES-BENZ

SPRINTER (906)

519 CDI / BlueTEC	2987	140	6	03.09-	OM642992, OM642896, OM642898, OM642986		EPBMFN4-D014H	92888		
519 CDI / BlueTEC 4x4	2987	140	6	03.09-	OM642992, OM642896, OM642898, OM642986		EPBMFN4-D014H	92888		
524	3498	190	6	06.06-12.13	M272979		EPBMFT5-V027H	94616		

SPRINTER (907, 910)

319 CDI	2987	140	6	02.18-	OM642899		EPBMFN4-D014H	92888		
319 CDI All-wheel Drive	2987	140	6	01.19-	OM642899		EPBMFN4-D014H	92888		
419 CDI	2987	140	6	02.18-	OM642899		EPBMFN4-D014H	92888		
419 CDI All-wheel Drive	2987	140	6	01.19-	OM642899		EPBMFN4-D014H	92888		
519 CDI	2987	140	6	02.18-	OM642899		EPBMFN4-D014H	92888		
519 CDI All-wheel Drive	2987	140	6	01.19-	OM642899		EPBMFN4-D014H	92888		

SPRINTER (909)

311 CDI	2148	80	4	09.13-	OM646701		EPBMFN4-D014H	92888		
411 CDI	2148	80	4	09.13-	OM646701		EPBMFN4-D014H	92888		

VANEO (414)

1.7 CDI	1689	55	4	02.02-07.05	OM668914		EPBMFN5-D004P	93343		
1.7 CDI	1689	67	4	02.02-07.05	OM668914		EPBMFN5-D004P	93343		

V-CLASS (638/2)

V 200	1998	95	4	02.97-07.03	M111948		EPBMFN5-D027H	94938	EPBMFN5-D002P	91609
V 200	1998	95	4	02.97-07.03	M111950		EPBMFT5-D009H	95803	EPBMFN5-D002P	91609
V 200 CDI	2151	75	4	03.99-07.03	OM611980		EPBMFT5-D009H	95803	EPBMFT5-D003P	96835
V 220 CDI	2151	90	4	03.99-07.03	OM611980		EPBMFT5-D009H	95803	EPBMFT5-D003P	96835
V 230	2295	105	4	10.96-07.03	M111980, M111978		EPBMFT5-D009H	95803	EPBMFT5-D003P	96835
V 230 TD	2299	72	4	09.96-07.03	OM601970		EPBMFN5-D027H	94938		
V 280	2792	128	6	12.97-07.03	M104900		EPBMFN5-D027H	94938		

VIANO (W639)

CDI 2.0	2148	80	4	09.03-	OM646982		EPBMFN4-D004H	91534		
CDI 2.0 4-matic	2148	80	4	07.05-	OM646982		EPBMFN4-D004H	91534		
CDI 2.0	2148	85	4	08.05-	OM646982		EPBMFN4-D004H	91534		
CDI 2.0 4-matic	2148	85	4	03.06-	OM646982		EPBMFN4-D004H	91534		
CDI 2.2	2148	110	4	09.03-	OM646982, OM646980		EPBMFN4-D004H	91534		
CDI 2.2 4-matic	2148	110	4	07.05-	OM646982		EPBMFN4-D004H	91534		
CDI 3.0	2987	150	6	03.06-	OM642990	Euro4; Euro5	EPBMFN4-D014H	92888		
CDI 3.0	2987	165	6	07.10-	OM642890		EPBMFN4-D014H	92888		
3.0	3199	140	6	09.03-	M112951		EPBMFT5-D025H	90977		
3.2	3199	160	6	09.03-	M112951		EPBMFT5-D025H	90977		
3.5	3498	190	6	09.07-	M272978		EPBMFT5-V027H	94616		
3.7	3724	165	6	06.04-07.07	M112976		EPBMFT5-D025H	90977		
3.7	3724	170	6	06.04-	M112976		EPBMFT5-D025H	90977		

VITO (638)

113 2.0	1998	95	4	02.96-07.03	M111948, M111950		EPBMFN5-D027H	94938	EPBMFN5-D002P	91609
---------	------	----	---	-------------	------------------	--	---------------	-------	---------------	-------





Type-Nº







Stock-Nº

Plug In Alternative Type-Nº

Plug In Subtype

MERCEDES-BENZ

VITO (638)

113 2.0	1998	95	4	02.96-07.03	M111948, M111950		EPBMFT5-D009H	95803	EPBMFN5-D002P	91609
108 CDI 2.2	2148	60	4	03.99-07.03	OM611A		EPBMFT5-D009H	95803	EPBMFT5-D003P	96835
110 CDI 2.2	2148	75	4	03.99-07.03	OM611LA		EPBMFT5-D009H	95803	EPBMFT5-D003P	96835
108 CDI 2.2	2151	60	4	03.99-07.03	OM611A		EPBMFT5-D009H	95803	EPBMFT5-D003P	96835
110 CDI 2.2	2151	75	4	03.99-07.03	OM611LA		EPBMFT5-D009H	95803	EPBMFT5-D003P	96835
112 CDI 2.2	2151	90	4	03.99-07.03	OM611980		EPBMFT5-D009H	95803	EPBMFT5-D003P	96835
114 2.3	2295	105	4	12.96-07.03	M111978, M111980		EPBMFT5-D009H	95803	EPBMFT5-D003P	96835
108 D 2.3	2299	58	4	02.96-07.03	OM601942	Transmission Type: 1	EPBMFN5-D027H	94938		
110 TD 2.3	2299	72	4	02.96-07.03	OM601970	Transmission Type: 1	EPBMFN5-D027H	94938		
110 D 2.3	2299	72	4	03.97-07.03	OM601970		EPBMFN5-D027H	94938		

VITO (W639)

110 CDI	2143	70	4	09.10-	OM651940		EPBMFN4-D004H	91534		
109 CDI	2148	65	4	09.03-	OM646983		EPBMFN4-D004H	91534		
109 CDI	2148	70	4	08.06-	OM646980, OM646981	Euro3	EPBMFN4-D004H	91534		
109 CDI	2148	70	4	08.06-	OM646980, OM646981	Euro4, Euro5	EPBMFN4-D014H	92888		
109 CDI 4x4	2148	70	4	09.07-	OM646981	Euro3	EPBMFN4-D004H	91534		
109 CDI 4x4	2148	70	4	09.07-	OM646981	Euro4, Euro5	EPBMFN4-D014H	92888		
111 CDI	2148	80	4	09.03-	OM646982		EPBMFN4-D004H	91534		
111 CDI 4x4	2148	80	4	09.07-	OM646982		EPBMFN4-D004H	91534		
111 CDI	2148	85	4	09.07-	OM646982, OM646980		EPBMFN4-D004H	91534		
115 CDI	2148	110	4	09.03-	OM646982, OM646980	for SA code:MP3, MC3, MP4	EPBMFN4-D004H	91534		
115 CDI 4x4	2148	110	4	07.06-	OM646982		EPBMFN4-D004H	91534		
120 CDI	2987	150	6	07.06-	OM642990	Euro4, Euro5	EPBMFN4-D014H	92888		
122 CDI	2987	165	6	09.10-	OM642890		EPBMFN4-D014H	92888		
119	3199	140	6	09.03-	M112951		EPBMFT5-D025H	90977		
122	3199	160	6	09.03-	M112951		EPBMFT5-D025H	90977		
126	3498	190	6	09.07-	M272978		EPBMFT5-V027H	94616		
123	3724	165	6	06.04-07.08	M112976		EPBMFT5-D025H	90977		
123	3724	170	6	06.04-	M112976		EPBMFT5-D025H	90977		

MG

EXPRESS HATCHBACK VAN

2.0 TD	1994	74	4	03.03-05.05	20T2N		EPBMFT5-V031H	97525		
--------	------	----	---	-------------	-------	---	---------------	-------	--	--



MG 6 HATCHBACK/SALOON

1.8 T	1795	118	4	11.10-	18K4G		EPBMFT5-V001P	93006		
-------	------	-----	---	--------	-------	---	---------------	-------	--	--

ZR

2.0 TD	1994	74	4	06.01-04.05	20T2N		EPBMFT5-V031H	97525		
2.0 TD	1994	83	4	12.02-04.05	20T2N		EPBMFT5-V031H	97525		

ZS

2.0 TD	1994	74	4	01.04-10.05	20T2N		EPBMFT5-V031H	97525		
2.0 TD	1994	83	4	01.04-10.05	20T2N		EPBMFT5-V031H	97525		

MAF



l kW
C
Y
I



Type-Nº

Stock-Nº

Plug In
Alternative
Type-Nº

Plug In
Subtype

MG

ZT / ZT-T

2.0 CDTi	1951	85	4	06.02-09.03	204D2		EPBMFT5-D015H	92304	EPBMFT5-D003P	96835
2.0 CDTi	1951	96	4	11.02-07.05	204D2		EPBMFT5-D015H	92304	EPBMFT5-D003P	96835

MINI

MINI (R55, R56, R57)

One D	1560	66	4	06.09-07.10	9HZ		EPBMFT5-A001H	93740		
Cooper D	1560	80	4	11.06-09.10	9HZ, W16D16		EPBMFT5-A001H	93740		
Cooper	1598	88	4	10.06-02.12	N12B16A, N16B16A		EPBMFN5-A038H	93095		
Cooper S	1598	120	4	10.07-06.14	N14B16A, N14B16AB, N18B16A		EPBMFN5-A038H	93095		
Cooper S	1598	128	4	04.08-07.10	N14B16A, N14B16AB		EPBMFN5-A038H	93095		
Cooper S	1598	141	4	04.08-07.10	N14B16A, N14B16AB		EPBMFN5-A038H	93095		
Cooper S John Cooper Works	1598	141	4	10.08-02.10	N14B16A, N14B16AB		EPBMFN5-A038H	93095		

MITSUBISHI

ASX (GA_W_)

1.8 DI-D	1798	85	4	06.10-	4N13		EPBMFT5-V002D	97692		
1.8 DI-D 4WD	1798	85	4	06.10-	4N13		EPBMFT5-V002D	97692		
1.8 DI-D	1798	110	4	06.10-	4N13		EPBMFT5-V002D	97692		
1.8 DI-D 4WD	1798	110	4	06.10-	4N13		EPBMFT5-V002D	97692		

ASX III (GA_W_)

1.6 DI-D	1560	84	4	07.15-	9HD		EPBMWT4-A026H	95537		
1.6 DI-D 4WD	1560	84	4	07.15-	9HD		EPBMWT4-A026H	95537		

ASX VAN (GA_W_)

1.8 DI-D 4WD	1798	110	4	06.10-	4N13		EPBMFT5-V002D	97692		
--------------	------	-----	---	--------	------	--	---------------	-------	--	--

CARISMA (DA_)

1.9 DI-D	1870	75	4	09.00-06.06	F9Q1		EPBMWT6-A001H	90144		
1.9 DI-D	1870	85	4	09.00-06.06	F9Q2		EPBMWT6-A001H	90144		

COLT VI (Z3_A, Z2_A)

1.5 DI-D	1493	50	3	08.04-06.12	OM639939		EPBMFT4-D050H	94911		
1.5 DI-D	1493	70	3	08.04-06.12	OM639939		EPBMFT4-D050H	94911		

L200 (K7_T, K6_T) | COLT / RODEO | STRAKER

2.5 TDiC	2477	74	4	08.01-09.05	4D56-T		EPBMWT5-A014D	90205		
2.5 TD 4WD	2477	98	4	08.01-12.07	4D56T		EPBMWT5-A014D	90205		

L200 / TRITON (KA_T, KB_T) | HUNTER

2.5 D	2477	66	4	08.11-12.15	4D56-TD		EPBMWT5-A014D	90205		
2.5 DI-D	2477	94	4	04.10-12.15	4D56, 4D56HP		EPBMWT5-A005D	93145		
2.5 DI-D 16V 4WD	2477	98	4	04.07-12.15	4D56		EPBMWT5-A005D	93145		
2.5 DiD	2477	100	4	11.05-12.15	4D56HP		EPBMWT5-A014D	90205		
2.5 DI-D 4WD	2477	100	4	11.05-12.15	4D56HP		EPBMWT5-A014D	90205		
2.5 DI-D	2477	123	4	08.07-12.15	4D56HP		EPBMWT5-A005D	93145		



MAF



l kW
C
y
I



Type-Nº

Stock-Nº

Plug In
Alternative
Type-Nº

Plug In
Subtype

MITSUBISHI

L200 / TRITON (KA_T, KB_T) | HUNTER

2.5 DI-D 4WD	2477	123	4	10.07-12.15	4D56HP		EPBMWT5-A014D	90205		
2.5 DI-D	2477	131	4	01.10-12.15	4D56		EPBMWT5-A005D	93145		
2.5 DI-D 4WD	2477	131	4	04.10-12.15	4D56HP		EPBMWT5-A014D	90205		

LANCER VIII (CY_A, CZ_A, CX_A)

1.8 DI-D	1798	85	4	05.10-	4N13		EPBMFT5-V002D	97692		
1.8 DI-D	1798	110	4	06.10-	4N13		EPBMFT5-V002D	97692		

OUTLANDER II (CW_W)

2.0 DI-D	1968	103	4	02.07-11.12	BSY		EPBMFN5-D002H	91692		
2.2 DI-D 4WD	2179	115	4	08.07-11.12	4HK, 4HN		EPBMFT5-V002D	97692		

PAJERO IV (V8_W, V9_W, V9_V, V8_V)

3.2 DI-D	3200	118	4	02.07-	4M41		EPBMWT5-A005D	93145		
3.2 DI-D	3200	123	4	02.07-	4M41		EPBMWT5-A005D	93145		
3.2 DI-D GLS	3200	124	4	02.07-	4M41		EPBMWT5-A005D	93145		
3.2 DI-D	3200	125	4	02.07-	4M41		EPBMWT5-A005D	93145		
3.2 DI-D 4WD	3200	147	4	01.09-	4M41		EPBMWT5-A005D	93145		

PAJERO SPORT II (KH_, KG_) | MONTERO SPORT

2.5 DI-D	2477	131	4	07.08-12.15	4D56-HP		EPBMWT5-A014D	90205		
2.5 DI-D 4WD	2477	131	4	07.08-	4D56-HP		EPBMWT5-A014D	90205		
3.2 DI-D 4WD	3200	118	4	07.08-	4M41		EPBMWT5-A014D	90205		

SPACE STAR GROSSRAUMLIMOUSINE (DG_A)

1.9 DI-D	1870	75	4	02.01-12.04	F9Q1		EPBMWT6-A001H	90144		
1.9 DI-D	1870	85	4	10.02-12.04	F9Q2		EPBMWT6-A001H	90144		

NISSAN

350 Z (Z33)

3.5	3498	206	6	03.05-12.07	VQ35DE		EPBMFN5-V005D	90496		
3.5	3498	214	6	11.04-01.07	VQ35DE		EPBMFN5-V005D	90496		
3.5	3498	221	6	09.02-12.08	VQ35DE		EPBMFN5-V005D	90496		
3.5	3498	230	6	09.05-12.08	VQ35HR		EPBMFN5-V005D	90496		

370Z (Z34)

3.7	3696	241	6	01.10-	VQ37VHR		EPBMFN5-V005D	90496		
3.7	3696	243	6	06.09-	VQ37HR, VQ37VHR		EPBMFN5-V005D	90496		
3.7	3696	248	6	04.09-	VQ37VHR		EPBMFN5-V005D	90496		
NISMO 3.7	3696	253	6	06.13-	VQ37VHR		EPBMFN5-V005D	90496		

ALMERA II (N16)

1.5	1497	72	4	10.02-09.06	QG15DE		EPBMFT5-A052H	95671		
1.5	1497	72	4	07.04-09.06	QG15DE		EPBMWN5-V005H	93291		
1.5	1498	66	4	03.00-10.00	QG15DE		EPBMFN5-A029H	90647		
1.5	1498	66	4	03.00-11.06	QG15DE		EPBMFT5-A063H	91029		
1.5	1498	66	4	10.00-07.04	QG15DE		EPBMFT5-A052H	95671		
1.8	1769	84	4	01.00-10.00	QG18DE		EPBMFN5-A029H	90647		



MAF

 l kW
C
Y
I

Type-N°

Stock-N°

 Plug In
Alternative
Type-N°

 Plug In
stock-N°

NISSAN
ALMERA II (N16)

1.8	1769	84	4	07.00-11.02	QG18DE		EPBMFT5-A063H	91029		
1.8	1769	84	4	01.00-11.02	QG18DE		EPBMWN5-V005H	93291		
1.8	1769	84	4	10.00-11.02	QG18DE		EPBMFT5-A052H	95671		
1.8	1769	85	4	08.04-09.06	QG18DE		EPBMWN5-V005H	93291		
2.2 Di	2184	81	4	03.00-03.01	YD22DDT		EPBMFN5-A029H	90647		
2.2 Di	2184	81	4	02.03-04.03	YD22DDT		EPBMWN5-V005H	93291		
2.2 dCi	2184	82	4	09.03-09.06	YD22DDT		EPBMWN5-V005H	93291		
2.2 dCi	2184	100	4	09.03-09.06	YD22DDTi		EPBMWN5-V005H	93291		

ALMERA TINO (V10)

1.8	1769	84	4	08.00-11.00	QG18DE		EPBMFN5-A029H	90647		
1.8	1769	84	4	08.00-07.04	QG18DE		EPBMFT5-A052H	95671		
1.8	1769	84	4	08.04-02.06	QG18DE		EPBMWN5-V005H	93291		
1.8	1769	85	4	12.02-02.06	QG18DE		EPBMWN5-V005H	93291		
1.8	1769	85	4	12.02-07.04	QG18DE		EPBMFT5-A052H	95671		
2.2 dCi	2184	82	4	09.03-11.05	YD22DDT		EPBMWN5-V005H	93291		
2.2 dCi	2184	84	4	08.00-02.03	YD22DDTi		EPBMFN5-A029H	90647		
2.2 dCi	2184	84	4	03.03-05.03	YD22DDTi		EPBMWN5-V005H	93291		
2.2 dCi	2184	100	4	09.03-11.05	YD22DDTi		EPBMWN5-V005H	93291		

CUBE (Z12)

1.6 16V	1598	81	4	03.10-	HR16DE		EPBMFN5-V005D	90496		
---------	------	----	---	--------	--------	--	---------------	-------	--	--

GT-R (R35)

V6	3799	357	6	12.07-10.10	VR38DETT		EPBMFN5-V005D	90496		
V6	3799	390	6	10.10-09.11	VR38DETT		EPBMFN5-V005D	90496		
V6	3799	404	6	10.11-	VR38DETT		EPBMFN5-V005D	90496		

INTERSTAR (X70)

dCi 80	1870	60	4	04.02-08.06	F9Q772, F9Q774		EPBMFT6-A044H	92490		
dCi 100	2464	74	4	04.06-	G9U720, G9U754		EPBMWT6-A007H	93605		
dCi 120	2464	88	4	08.06-	G9U650		EPBMWT6-A007H	93605		

JUKE (F15)

1.2 DIG-T	1197	85	4	05.14-	HRA2DDT		EPBMFN5-V005D	90496		
1.5 dCi	1461	81	4	07.10-	K9K		EPBMWT4-A022H	93854		
1.6	1598	69	4	01.13-	HR16DE		EPBMFN5-V005D	90496		
1.6	1598	86	4	06.10-	HR16DE		EPBMFN5-V005D	90496		

KUBISTAR VAN (X76)

1.2	1149	44	4	08.03-	D7F764		EPBMWT6-V013H	92412		
1.5 dCi	1461	45	4	08.05-	K9K710, K9K714		EPBMWT6-V013H	92412		
1.5 dCi	1461	48	4	08.03-	K9K704		EPBMWT6-V013H	92412		
1.6 16V	1598	70	4	08.03-	K4M752		EPBMWT6-V013H	92412		



MAF



l kW
C
Y
I



Type-N°

Stock-N°

Plug In
Alternative
Type-N°

Plug In
Subtype

NISSAN

MICRA III (K12)

1.4 16V	1386	65	4	01.03-06.10	CR14DE		EPBMFN5-V005D	90496		
1.5 dCi	1461	60	4	09.03-06.10	K9K722	OE 8200358901	EPBMFT6-A049H	93243		
1.5 dCi	1461	63	4	06.05-06.10	K9K276	OE 8200358901	EPBMFT6-A049H	93243		
160 SR	1598	81	4	05.05-06.10	HR16DE		EPBMFN5-V005D	90496		

MICRA IV (K13_)

1.2	1198	56	3	05.10-	HR12DE		EPBMFN5-V005D	90496		
1.2	1198	59	3	05.10-	HR12DE		EPBMFN5-V005D	90496		
1.2 DIG-S	1198	72	3	03.11-	HR12DDR, HR12DR		EPBMFN5-V005D	90496		

MURANO I (Z50)

3.5 4x4	3498	172	6	08.03-09.08	VQ35DE		EPBMFN5-V005D	90496		
3.5 4x4	3498	180	6	11.04-06.08	VQ35DE		EPBMFN5-V005D	90496		

NOTE (E11, NE11)

1.5 dCi	1461	50	4	03.06-06.12	K9K700	OE 8200358901	EPBMFT6-A049H	93243		
1.5 dCi	1461	63	4	03.06-06.12	K9K276		EPBMWT4-A022H	93854		
1.5 dCi	1461	63	4	03.06-06.12	K9K276	OE 8200358901	EPBMFT6-A049H	93243		
1.5 dCi	1461	66	4	09.10-06.12	K9K276	OE 8200358901	EPBMFT6-A049H	93243		
1.5 dCi	1461	76	4	07.08-06.12	K9K292	OE 8200358901	EPBMFT6-A049H	93243		
1.6	1598	81	4	03.06-06.12	HR16DE		EPBMFN5-V005D	90496		

NOTE (E12)

1.2 LPG	1198	56	3	03.15-	HR12DE		EPBMFN5-V005D	90496		
1.2	1198	58	3	06.13-	HR12DE		EPBMFN5-V005D	90496		
1.2	1198	59	3	06.13-	HR12DE		EPBMFN5-V005D	90496		

NP300 NAVARA (D40)

2.5 dCi	2488	106	4	07.05-	YD25DDTi		EPBMFN5-V005D	90496		
2.5 dCi 4WD	2488	106	4	01.07-	YD25DDTi		EPBMFN5-V005D	90496		
2.5 dCi 4WD	2488	126	4	10.06-	YD25DDTi		EPBMFN5-V005D	90496		
2.5 dCi 4WD	2488	128	4	07.05-01.10	YD25DDTi	OE 226807S000	EPBMFN5-V005D	90496		
2.5 dCi 4WD	2488	140	4	12.09-	YD25DDTi		EPBMFN5-V005D	90496		
2.5 dCi	2488	140	4	03.10-	YD25DDTi		EPBMFN5-V005D	90496		

NV200

1.5 dci	1461	63	4	02.10-	K9K400, K9K608, K9K628	OE 8200358901	EPBMFT6-A049H	93243		
1.5 dci	1461	66	4	04.11-	K9K892		EPBMWT4-A022H	93854		
1.5 dci	1461	81	4	04.11-	K9K636, K9K646	OE 8200358901	EPBMFT6-A049H	93243		
1.6 16V	1598	81	4	02.10-	HR16DE		EPBMFN5-V005D	90496		

PATHFINDER II (R50) | TERRANO

3.5 V6 4WD	3498	162	6	11.00-12.04	VQ35		EPBMFN5-V005D	90496		
------------	------	-----	---	-------------	------	--	---------------	-------	--	--

PATHFINDER III (R51)

2.5 dCi 4WD	2488	120	4	01.05-	YD25DDTi		EPBMFN5-V005D	90496		
2.5 dCi 4WD	2488	126	4	10.06-	YD25DDTi		EPBMFN5-V005D	90496		



MAF



l kW
C
Y
I



Type-N°

Stock-N°

Plug In
Alternative
Type-N°

Plug In
Stock-N°

NISSAN

PATHFINDER III (R51)

2.5 dCi 4WD	2488	140	4	08.10-	YD25DDTi		EPBMFN5-V005D	90496		
4.0 4WD	3954	198	6	09.05-	VQ40DE		EPBMFN5-V005D	90496		

PICK UP (D22)

2.5 Di	2488	98	4	03.02-12.10	YD25DDTi		EPBMFN5-V005D	90496		
--------	------	----	---	-------------	----------	--	---------------	-------	--	--

PRIMASTAR (X83)

dCi 80	1870	60	4	03.01-	F9Q762	; Number of Poles:4	EPBMWT4-A019H	94808		
1.9 dCi 80	1870	60	4	09.02-	F9Q762	; Number of Poles:4	EPBMWT4-A019H	94808		
1.9 dCi 80	1870	60	4	-08.06	F9Q762		EPBMWT6-A001H	90144		
dCi 80	1870	60	4	-08.06	F9Q762		EPBMWT6-A001H	90144		
dCi 100	1870	74	4	03.01-	F9Q760	; Number of Poles:4	EPBMWT4-A019H	94808		
1.9 dCi 100	1870	74	4	07.02-08.06	F9Q760	; Number of Poles:4	EPBMWT4-A019H	94808		
1.9 dCi 100	1870	74	4	-08.06	F9Q760		EPBMWT6-A001H	90144		
dCi 100	1870	74	4	-08.06	F9Q760		EPBMWT6-A001H	90144		
2.0 dCi 90	1995	66	4	09.06-	M9R692, M9R782, M9R786		EPBMWT6-A007H	93605		
2.0 dCi 90	1995	66	4	09.06-	M9R782, M9R786, M9R692	; Equip. Var.: EL00, EL01, FLOP, FLOS, JL0P, JL0S	EPBMWT4-A019H	94808		
dCi 90	1995	66	4	09.06-	M9R692, M9R782, M9R786		EPBMWT6-A007H	93605		
dCi 90	1995	66	4	09.06-	M9R692, M9R782, M9R786	; Equip. Var.: EL00, EL01, FLOP, FLOS, JL0P, JL0S	EPBMWT4-A019H	94808		
2.0 dCi 115	1995	84	4	09.06-	M9R780, M9R630, M9R786, M9R692	; Equip. Var.: EL00, EL01, FLOP, FLOS, JL0P, JL0S	EPBMWT4-A019H	94808		
dCi 120	1995	84	4	09.06-	M9R692, M9R780, M9R786		EPBMWT6-A007H	93605		
dCi 120	1995	84	4	09.06-	M9R692, M9R780, M9R786	; Equip. Var.: EL00, EL01, FLOP, FLOS, JL0P, JL0S	EPBMWT4-A019H	94808		
2.0	1998	88	4	03.01-	F4R720, F4R722	; Number of Poles:4	EPBMWT4-A019H	94808		
2.5 dCi 115	2464	84	4	09.08-	G9U630	; Equip. Var.: EL00, EL01, FLOP, FLOS, JL0P, JL0S	EPBMWT4-A019H	94808		
dCi 115	2464	84	4	09.08-	G9U630	; Equip. Var.: EL00, EL01, FLOP, FLOS, JL0P, JL0S	EPBMWT4-A019H	94808		
2.5 dCi 140	2464	99	4	07.03-	G9U730	; Number of Poles:4	EPBMWT4-A019H	94808		
dCi 140	2464	99	4	07.03-	G9U730	; Number of Poles:4	EPBMWT4-A019H	94808		
2.5 dCi 140	2464	99	4	-08.06	G9U730		EPBMWT6-A001H	90144		
dCi 140	2464	99	4	-08.06	G9U730		EPBMWT6-A001H	90144		
2.5 dCi 150	2464	107	4	09.06-	G9U632		EPBMWT6-A001H	90144		
2.5 dCi 150	2464	107	4	09.06-	G9U632	; Number of Poles:4	EPBMWT4-A019H	94808		
dCi 150	2464	107	4	09.06-	G9U632		EPBMWT6-A001H	90144		
dCi 150	2464	107	4	09.06-	G9U632	; Number of Poles:4	EPBMWT4-A019H	94808		



MAF



l kW
C
Y
I



Type-Nº

Stock-Nº

Plug In
Alternative
Type-Nº

Plug In
Subtype

NISSAN

PRIMERA (P11, WP11)

1.6 16V	1597	73	4	07.99-10.00	GA16DE		EPBMFN5-A029H	90647		
1.6 16V	1597	78	4	06.96-12.01	QG16DE		EPBMWN5-V005H	93291		
1.6 16V	1597	78	4	06.99-09.00	QG16DE		EPBMFN5-A029H	90647		
1.6 16V	1597	78	4	09.00-12.01	QG16DE		EPBMFT5-A052H	95671		
1.8 16V	1769	84	4	08.99-09.00	QG18DE		EPBMFN5-A029H	90647		
1.8 16V	1769	84	4	08.99-07.02	QG18DE		EPBMWN5-V005H	93291		
1.8 16V LPG	1769	84	4	08.99-07.02	QG18DE		EPBMFN5-A029H	90647		
1.8 16V	1769	84	4	09.00-02.02	QG18DE		EPBMFT5-A052H	95671		
2.0 TD	1974	66	4	09.96-10.97	CD20T		EPBMWN3-V031H	90825		
2.0 TD	1974	66	4	04.98-12.01	CD20T		EPBMFT5-V042H	94057	EPBMFT5-V001P	93006
2.0 16V	1998	96	4	04.98-06.99	SR20DE		EPBMWN3-V031H	90825		

PRIMERA (P12, WP12)

1.6	1597	78	4	03.02-06.04	QG16DE		EPBMFT5-A052H	95671		
1.6	1597	78	4	07.04-08.08	QG16DE		EPBMWN5-V005H	93291		
1.6	1597	80	4	01.02-04.06	QG16DE		EPBMWN5-V005H	93291		
1.6	1597	80	4	01.02-06.04	QG16DE		EPBMFT5-A052H	95671		
1.6 Visia	1597	80	4	01.02-04.06	QG16DE		EPBMWN5-V005H	93291		
1.6 Visia	1597	80	4	01.02-04.06	QG16DE		EPBMFT5-A052H	95671		
1.6	1597	80	4	06.04-04.06	QG16DE		EPBMFN5-V005D	90496		
1.8	1769	85	4	03.02-05.07	QG18DE		EPBMWN5-V005H	93291		
1.8 LPG	1769	85	4	03.02-	QG18DE		EPBMFT5-A052H	95671		
1.8	1769	85	4	01.03-06.04	QG18DE		EPBMFT5-A052H	95671		
1.9 dCi	1870	85	4	-12.06	F9Q		EPBMWT6-A001H	90144		
1.9 dCi	1870	88	4	-12.06	F9Q		EPBMWT6-A001H	90144		
2.2 Di	2184	93	4	03.02-04.03	YD22DDT		EPBMFN5-A029H	90647		
2.2 Di	2184	93	4	03.02-04.03	YD22DDT		EPBMWN5-V005H	93291		
2.2 dCi	2184	102	4	04.03-	YD22DDT		EPBMWN5-V005H	93291		

QASHQAI / QASHQAI +2 I (J10, NJ10, JJ10E)

1.5 dCi	1461	76	4	07.08-12.13	K9K282, K9K292	; Not for Euro5	EPBMWT6-A007H	93605		
1.5 dCi	1461	78	4	02.07-12.13	K9K282, K9K292	; Not for Euro5	EPBMWT6-A007H	93605		
1.5 dCi	1461	81	4	01.10-12.13	K9K430	; Not for Euro5	EPBMWT6-A007H	93605		
1.6	1598	84	4	02.07-12.13	HR16DE		EPBMFN5-V005D	90496		
1.6	1598	86	4	06.13-12.13	HR16DE		EPBMFN5-V005D	90496		
2.0 dCi	1995	110	4	02.07-12.13	M1D, M9R		EPBMFN5-V005D	90496		
2.0 dCi Allrad	1995	110	4	02.07-12.13	M1D, M9R		EPBMFN5-V005D	90496		
2.0 Allrad	1997	102	4	02.07-12.13	MR20DE		EPBMFN5-V005D	90496		
2.0	1997	102	4	08.08-12.13	MR20DE		EPBMFN5-V005D	90496		
2.0 Allrad	1997	104	4	02.07-12.13	MR20DE		EPBMFN5-V005D	90496		
2.0	1997	104	4	08.08-06.13	MR20DE		EPBMFN5-V005D	90496		



MAF



l kW
C
Y
I



Type-Nº

Stock-Nº

Plug In
Alternative
Type-Nº

Plug In
Subtype

NISSAN

QASHQAI II SUV (J11, J11_)

2.0	1997	106	4	06.14-	MR20DD		EPBMFN5-V005D	90496		
2.0	1997	106	4	06.14-	MR20DD		EPBMWN5-V005H	93291		
2.0 ALL MODE 4x4-i	1997	106	4	10.15-	MR20DD		EPBMFN5-V005D	90496		

TEANA I (J31)

2.0	1998	103	4	10.03-06.08	QR20DE		EPBMFN5-V005D	90496		
2.3	2349	127	6	10.03-06.08	VQ23DE		EPBMFN5-V005D	90496		
3.5	3498	170	6	10.03-06.08	VQ35DE		EPBMFN5-V005D	90496		

TEANA II (J32)

2.5	2496	134	6	07.08-09.13	VQ25DE		EPBMFN5-V005D	90496		
3.5	3498	183	6	07.08-09.13	VQ35DE		EPBMFN5-V005D	90496		

TERRANO II (R20)

2.7 TDi 4WD	2664	92	4	06.98-09.07	TD27TI		EPBMFT5-V042H	94057		
2.7 TDi 4WD	2664	92	4	10.99-02.02	TD27TI		EPBMWN3-V031H	90825	EPBMFT5-V001P	93006

TIIDA HATCHBACK (C11)

1.5 dCi	1461	78	4	09.07-12.11	K9K, K9K278		EPBMFN5-V005D	90496		
1.8	1798	93	4	09.07-12.11	MR18DE		EPBMFN5-V005D	90496		

X-TRAIL (T30)

2.0	1998	103	4	02.05-01.13	QR20DE		EPBMFN5-V005D	90496		
2.0 4x4	1998	103	4	02.05-01.13	QR20DE		EPBMFN5-V005D	90496		
2.2 Di 4x4	2184	84	4	07.01-10.05	YD22DDTi, YD22ETi		EPBMFN5-V005D	90496		
2.2 dCi 4x4	2184	100	4	06.01-12.08	YD22DDTi, YD22ETi		EPBMWN5-V005H	93291		
2.2 dCi 4x4	2184	100	4	06.01-12.08	YD22DDTi		EPBMFN5-V005D	90496		
2.2 dCi	2184	100	4	12.03-01.13	YD22DDTi, YD22ETi		EPBMWN5-V005H	93291		
2.5 4x4	2488	121	4	09.03-01.13	QR25DE		EPBMFN5-V005D	90496		

X-TRAIL (T31)

2.0	1998	103	4	06.08-11.13	MR20DE		EPBMFN5-V005D	90496		
2.0 FWD	1998	103	4	06.08-11.13	MR20DE		EPBMFN5-V005D	90496		
2.0	1997	104	4	06.07-11.13	MR20DE		EPBMFN5-V005D	90496		
2.0 FWD	1997	104	4	03.07-11.13	MR20DE		EPBMFN5-V005D	90496		
2.0 dCi 4x4	1995	110	4	06.07-11.13	M9R		EPBMFN5-V005D	90496		
2.0 dCi FWD	1995	110	4	06.07-11.13	M9R		EPBMFN5-V005D	90496		
2.0 dCi	1995	127	4	06.07-11.13	M9R760		EPBMFN5-V005D	90496		
2.5 4x4	2488	124	4	06.07-11.13	QR25DE		EPBMFN5-V005D	90496		

OPEL

ADAM (M13)

1.2	1229	51	4	10.12-02.19	A12XEL, B12XEL, D12XEL		EPBMFT5-T001D	94095		
1.4	1398	64	4	10.12-02.19	A14XEL, B14XEL, D14XEL		EPBMFT5-T001D	94095		
1.4 LPG	1398	64	4	07.13-11.18	A14XEL, B14XEL, D14XEL		EPBMFT5-T001D	94095		
1.4	1398	74	4	10.12-02.19	A14XER, B14XER, D14XER		EPBMFT5-T001D	94095		



MAF



l kW
C
Y
I



Type-Nº

Stock-Nº

Plug In
Alternative
Type-Nº

Plug In
Subtype

OPEL

AGILA (A) (H00)

1.0 12V	973	43	3	09.00-08.03	Z10XE		EPBMFT5-V007H	97257	EPBMFT5-V001P	93006
1.0	998	44	3	08.03-12.07	Z10XEP		EPBMFT5-V007H	97257	EPBMFT5-V001P	93006
1.2 16V	1199	55	4	09.00-06.04	Z12XE		EPBMFT5-V007H	97257	EPBMFT5-V001P	93006
1.2 16V Twinport	1229	59	4	07.04-12.07	Z12XEP		EPBMFT5-V007H	97257	EPBMFT5-V001P	93006
1.3 CDTI	1248	51	4	08.03-12.07	Z13DT		EPBMFT5-V029H	90502	EPBMFT5-V001P	93006

AGILA (B) (H08)

1.3 CDTI	1248	55	4	04.08-04.10	D13A, Z13DTJ		EPBMFN4-V031H	96741		
----------	------	----	---	-------------	--------------	--	---------------	-------	--	--

AMPERA (R12)

EV 150	1398	111	4	11.11-03.15	A14XFL		EPBMFT5-T001D	94095		
--------	------	-----	---	-------------	--------	--	---------------	-------	--	--

ANTARA (L07)

2.0 CDTI	1991	93	4	03.07-12.11	Z20S, Z20DM		EPBMFN4-V010H	97588		
2.0 CDTI	1991	93	4	09.08-12.11	Z20DM		EPBMFN4-V026H	94497		
2.0 CDTI	1991	110	4	08.06-12.11	Z20DMH, Z20S		EPBMFN4-V010H	97588		
2.0 CDTI	1991	110	4	08.06-12.11	Z20DMH		EPBMFN4-V026H	94497		
2.0 CDTI 4x4	1991	110	4	07.06-12.11	Z20DMH, Z20S		EPBMFN4-V010H	97588		
2.0 CDTI 4x4	1991	110	4	07.06-12.11	Z20DMH		EPBMFN4-V026H	94497		

ASTRA F (T92)

1.8 i 16V	1796	85	4	09.95-08.97	C18SEL		EPBMWN4-A019H	92343		
1.8 i 16V	1799	85	4	07.94-01.98	C18XEL, X18XE		EPBMWN4-A019H	92343		
1.8 i 16V	1799	92	4	06.93-01.98	C18XE		EPBMWN4-A019H	92343		
2.0 i 16V	1998	100	4	02.95-01.98	X20XEV		EPBMWN4-A019H	92343		

ASTRA G (T98, F35, F70)

1.2 16V	1199	48	4	02.98-09.00	X12XE		EPBMFT5-V007H	97257	EPBMFT5-V001P	93006
1.2 16V	1199	55	4	09.00-09.03	Z12XE		EPBMFT5-V007H	97257	EPBMFT5-V001P	93006
1.4	1364	66	4	09.07-12.09	Z14XEP		EPBMFT5-V007H	97257	EPBMFT5-V001P	93006
1.4	1364	66	4	09.07-12.09	Z14XEP	OE 25358054	EPBMWT5-V010H	93933		
1.6 16V	1598	76	4	03.00-05.05	Z16XEP	OE 25358054	EPBMWT5-V010H	93933		
1.6	1598	76	4	01.03-10.05	Z16XEP	OE 25358054	EPBMWT5-V010H	93933		
1.7 TD	1700	50	4	02.98-08.00	X17DTL		EPBMFT5-V017H	90311		
1.7 TD	1700	50	4	01.99-08.00	X17DTL		EPBMFT5-V001P	93006		
1.7 DTI 16V	1686	55	4	02.00-01.04	Y17DT		EPBMFT5-V001P	93006		
1.7 DTI 16V	1686	55	4	-01.04	Y17DT		EPBMFT5-V017H	90311		
1.7 CDTI	1686	59	4	04.03-06.04	Z17DTL		EPBMFT5-V001P	93006		
1.7 CDTI	1686	59	4	04.03-07.09	Z17DTL		EPBMFT5-V010H	96310	EPBMFT5-V001P	93006
1.8 16V	1796	85	4	02.98-09.00	X18XE1		EPBMWT4-V002H	92668		
1.8 16V	1796	92	4	03.01-10.05	Z18XE		EPBMWT4-V002H	92668		
2.0 DI	1995	60	4	02.98-07.04	X20DTL, Y20DTL	; Chass.18000001; Chass.>1H000001; Chass.>16000001; Chass.>12000001; Chass.>15000001	EPBMFT5-V017H	90311		
2.0 DI	1995	60	4	01.99-08.00	X20DTL, Y20DTL		EPBMFT5-V001P	93006		



MAF



l kW
C
Y
I



Type-N°

Stock-N°

Plug In
Alternative
Type-N°

Plug In
Stock-N°

OPEL

ASTRA G (T98, F35, F70)

2.0 DTI 16V	1995	74	4	08.99-01.05	Y20DTH		EPBMFT5-V001P	93006		
2.0 DTI 16V	1995	74	4	08.99-01.05	Y20DTH	; Chass.>18000001; Chass.>1H000001; Chass.>16000001; Chass.>12000001; Chass.>15000001; Chass.38000001; Chass.>3B000001; Chass.>3H000001; Chass.>32000001; Chass.>35000001; Chass.>36000001	EPBMFT5-V017H	90311		
2.0 DTI 16V	1995	74	4	08.99-07.04	Y20DTH	; Chass.>38000001; Chass.>3B000001; Chass.>3H000001; Chass.>32000001; Chass.>35000001; Chass.>36000001	EPBMFT5-V010H	96310		
2.0 16V	1998	100	4	02.98-01.05	C20SEL, X20XEV		EPBMWT4-V002H	92668		
2.0 16V OPC	1998	118	4	11.99-09.02	X20XER		EPBMWT4-V002H	92668		
2.0 16V Turbo	1998	140	4	09.00-08.01	Z20LET		EPBMFT5-V017H	90311	EPBMFT5-V001P	93006
2.0 16V Turbo	1998	141	4	08.01-05.05	Z20LET		EPBMFT5-V017H	90311	EPBMFT5-V001P	93006
2.0 OPC	1998	141	4	-01.04	Z20LET		EPBMFT5-V017H	90311		
2.0 16V Turbo	1998	147	4	11.02-05.05	Z20LET		EPBMFT5-V017H	90311	EPBMFT5-V001P	93006
2.0 OPC	1998	147	4	11.02-01.04	Z20LET		EPBMFT5-V017H	90311	EPBMFT5-V001P	93006

ASTRA H (A04, L70)

1.2	1229	59	4	08.05-10.10	Z12XEP		EPBMFT5-V001P	93006		
1.3 CDTI	1248	66	4	01.09-	Z13DTH		EPBMFN4-V026H	94497		
1.3 CDTI	1248	66	4	01.09-	Z13DTH		EPBMFN4-V010H	97588		
1.4	1364	55	4	03.05-02.09	Z14XEL		EPBMFT5-V007H	97257		
1.4	1364	66	4	01.09-	Z14XEP		EPBMFT5-V007H	97257		
1.4 LPG	1364	66	4	08.09-03.10	Z14XEP		EPBMFT5-V007H	97257	EPBMFT5-V001P	93006
1.6 EcoTec	1598	76	4	02.04-11.04	Z16XEP	; Chass.<78999999; Chass.<7G; Chass.<72999999; Chass.<75999999	EPBMWT5-V010H	93933		
1.6	1598	77	4	03.04-10.10	Z16XE1, Z16XEP	; Chass.<78999999; Chass.<7G; Chass.<72999999; Chass.<75999999	EPBMWT5-V010H	93933		
1.6 Turbo	1598	132	4	02.07-10.10	A16LET, Z16LET	; Ecotec	EPBMFT5-V017H	90311	EPBMFT5-V001P	93006
1.7 CDTI	1686	59	4	03.04-10.10	Z17DTL		EPBMFN4-V026H	94497		
1.7 CDTI	1686	59	4	03.04-09.05	Z17DTL		EPBMFN4-V010H	97588		
1.7 CDTi	1686	74	4	02.07-10.10	Z17DTH		EPBMFN4-V026H	94497		
1.7 CDTi	1686	74	4	02.07-10.10	Z17DTH		EPBMFN4-V010H	97588		
1.7 CDTi	1686	81	4	01.09-	A17DTJ, Z17DTJ		EPBMFT5-V006H	94366		
1.7 CDTI	1686	92	4	02.07-05.14	Z17DTR, A17DTR		EPBMFT5-V006H	94366		
1.8	1796	92	4	01.04-10.10	Z18XE		EPBMWN4-A019H	92343		
1.8	1796	92	4	03.05-10.10	Z18XE		EPBMWT4-V002H	92668		



MAF



l kW
C
Y
I



Type-N°

Stock-N°

Plug In
Alternative
Type-N°

Plug In
Subtype

OPEL

ASTRA H (A04, L70)

1.8	1796	103	4	01.06-10.10	A18XER, Z18XER		EPBMFT4-V048H	95493		
1.9 CDTi	1910	74	4	01.06-10.10	Z19DTL		EPBMFN4-V026H	94497		
1.9 CDTi	1910	74	4	01.06-10.10	Z19DTL		EPBMFN4-V010H	97588		
1.9 CDTi	1910	88	4	06.04-10.10	Z19DT		EPBMFN4-V026H	94497		
1.9 CDTi	1910	88	4	06.04-10.10	Z19DT		EPBMFN4-V010H	97588		
1.9 CDTi 16V	1910	88	4	03.05-10.10	Z19DTJ		EPBMFN4-V026H	94497		
1.9 CDTi 16V	1910	88	4	03.05-10.10	Z19DTJ		EPBMFN4-V010H	97588		
1.9 CDTi	1910	110	4	03.05-10.10	Z19DTH		EPBMFN4-V026H	94497		
1.9 CDTi	1910	110	4	03.05-10.10	Z19DTH		EPBMFN4-V010H	97588		
2.0 Turbo	1998	125	4	03.04-02.09	Z20LEL		EPBMFT5-V017H	90311	EPBMFT5-V001P	93006
2.0 Turbo	1998	147	4	03.05-09.09	Z20LER		EPBMFT5-V001P	93006		
2.0 Turbo	1998	177	4	03.05-10.10	Z20LEH	; Chass.62000001	EPBMFT5-V020H	90244		

ASTRA J (P10)

1.3 CDTi	1248	70	4	05.13-10.15	A13DTE		EPBMFT5-T011H	92630		
1.4	1398	64	4	12.09-10.15	A14XEL		EPBMFT5-T001D	94095		
1.4	1398	64	4	10.10-10.15	A14XEL		EPBMFT5-T011H	92630		
1.4	1398	74	4	10.11-10.15	A14XER		EPBMFT5-T011H	92630		
1.4	1398	74	4	06.12-10.15	A14XER, B14XER		EPBMFT5-T001D	94095		
1.4	1364	88	4	10.11-	A14NEL, B14NEL		EPBMFT5-T001D	94095		
1.4 Turbo	1364	88	4	06.12-10.15	A14NEL, B14NEL		EPBMFT5-T001D	94095		
1.4	1364	103	4	10.11-	A14NET, B14NET		EPBMFT5-T001D	94095		
1.4 LPG	1364	103	4	01.12-10.15	A14NET		EPBMFT5-T001D	94095		
1.4 Turbo	1364	103	4	06.12-	A14NET, B14NET		EPBMFT5-T001D	94095		
1.6 CDTi	1598	81	4	02.14-10.15	B16DTL		EPBMFT5-T001D	94095		
1.6	1598	85	4	06.12-	A16XER, B16XER		EPBMFT5-T001D	94095		
1.6 CDTi	1598	100	4	01.14-	B16DTH		EPBMFT5-T001D	94095		
1.6	1598	132	4	10.11-	A16LET		EPBMFT5-T001D	94095		
1.6 Turbo	1598	132	4	06.12-	A16LET		EPBMFT5-T001D	94095		
1.7 CDTi	1686	74	4	10.10-10.15	A17DTL, A17DTN		EPBMFT5-T011H	92630		
1.7 CDTi	1686	81	4	06.12-10.15	A17DTC		EPBMFT5-T001D	94095		
1.7 CDTi	1686	81	4	06.12-10.15	A17DTJ, A17DTC, A17DTE		EPBMFT5-T011H	92630		
1.7 CDTi	1686	92	4	10.10-10.15	A17DTR		EPBMFT5-T011H	92630		
1.7 CDTi	1686	96	4	10.11-10.15	A17DTF		EPBMFT5-T011H	92630		
1.7 CDTi	1686	96	4	06.12-10.15	A17DTS		EPBMFT5-T001D	94095		
1.8	1796	103	4	10.11-10.15	A18XER		EPBMFT5-T001D	94095		
2.0 CDTi	1956	96	4	04.15-10.15	A20DTH		EPBMFT5-T003H	91493		
2.0 CDTi	1956	118	4	09.09-10.15	A20DTH		EPBMFT5-T003H	91493		
2.0 CDTi	1956	121	4	06.11-10.15	A20DTH		EPBMFT5-T003H	91493		



MAF



l kW
C
Y
I



Type-N°

Stock-N°

Plug In
Alternative
Type-N°

Plug In
Subtype

OPEL

ASTRA J (P10)

2.0 BiTurbo CDTI	1956	143	4	09.12-10.15	A20DTR		EPBMFT5-T003H	91493		
------------------	------	-----	---	-------------	--------	--	---------------	-------	--	--

ASTRA K (B16)

1.6 CDTi	1598	70	4	06.15-	B16DTE		EPBMFT5-T001D	94095		
1.6 CDTi	1598	81	4	06.15-	B16DTE, B16DTU, D16DTI		EPBMFT5-T001D	94095		
1.6 CDTi	1598	100	4	06.15-	B16DTH, D16DTH		EPBMFT5-T001D	94095		
1.6 CDTi	1598	118	4	11.15-	B16DTR		EPBMFT5-T001D	94095		

CALIBRA A (C89)

2.0 i 4x4	1998	85	4	03.97-07.97	C20NE		EPBMWN4-A019H	92343		
2.0 i 16V	1998	100	4	02.94-07.97	X20XEV		EPBMWN4-A019H	92343		
2.0 i 16V 4x4	1998	100	4	02.94-07.97	X20XEV		EPBMWN4-A019H	92343		

CAMPO (TF0, TF1)

2.5 TD	2499	56	4	07.94-06.01	4JA1-T		EPBMFT5-V035H	94119		
2.5 TD 4x4	2499	56	4	07.94-06.01	4JA1-T		EPBMFT5-V035H	94119		

CASCADA (W13)

2.0 CDTI	1956	121	4	04.13-	A20DTH		EPBMFT5-T003H	91493		
2.0 CDTI	1956	143	4	04.13-	A20DTR		EPBMFT5-T003H	91493		

COMBO (X12)

1.3 CDTI	1248	66	4	02.12-	A13FD		EPBMFT4-V004H	90957		
1.3 CDTI	1248	66	4	02.12-	A13FD		EPBMFN4-V017H	96226		
1.3 CDTI	1248	70	4	03.16-	A13FD		EPBMFT4-V004H	90957		
1.3 CDTI	1248	70	4	03.16-	A13FD		EPBMFN4-V017H	96226		
1.6 CDTI	1598	66	4	02.12-	A16FDL		EPBMFT4-V004H	90957		
1.6 CDTI	1598	70	4	03.15-	A16FDL		EPBMFT4-V004H	90957		
1.6 CDTI	1598	77	4	02.12-	A16FDH		EPBMFT4-V004H	90957		
1.6 CDTI	1598	88	4	03.15-	A16FDL		EPBMFT4-V004H	90957		
1.7 DI 16V	1686	48	4	-08.04	Y17DTL		EPBMFT5-V017H	90311		
1.7 DTI 16V	1686	55	4	-08.04	Y17DT		EPBMFT5-V017H	90311		
2.0 CDTI	1956	99	4	02.12-	A20FD		EPBMFT4-V004H	90957		

COMBO BOX BODY/MPV

1.3 CDTI 16V	1248	51	4	08.05-09.07	Z13DT		EPBMFT5-V010H	96310	EPBMFT5-V001P	93006
1.3 CDTI 16V	1248	55	4	10.05-12.12	Z13DTJ		EPBMFN4-V026H	94497		
1.3 CDTI 16V	1248	55	4	10.05-12.12	Z13DTJ		EPBMFN4-V010H	97588		
1.4 16V	1364	66	4	08.05-01.11	Z14XEP		EPBMFT5-V007H	97257	EPBMFT5-V001P	93006
1.7 DI 16V	1686	48	4	10.01-08.04	Y17DTL		EPBMFT5-V001P	93006		
1.7 DTI 16V	1686	55	4	10.01-08.04	Y17DT		EPBMFT5-V001P	93006		
1.7 CDTI 16V	1686	74	4	12.04-01.11	Z17DTH		EPBMFT5-V010H	96310	EPBMFT5-V001P	93006

COMBO TOUR

1.3 CDTI 16V	1248	51	4	06.04-08.07	Y13DT, Z13DT		EPBMFT5-V010H	96310	EPBMFT5-V001P	93006
1.3 CDTI 16V	1248	55	4	10.05-12.11	Z13DTJ		EPBMFN4-V026H	94497		
1.3 CDTI 16V	1248	55	4	10.05-12.11	Z13DTJ		EPBMFN4-V010H	97588		



MAF



l kW
C
y
I



Type-Nº

Stock-Nº

Plug In
Alternative
Type-Nº

Plug In
Subtype

OPEL

COMBO TOUR

1.4	1364	66	4	10.04-01.11	Z14XEP		EPBMFT5-V007H	97257	EPBMFT5-V001P	93006
1.7 DI 16V	1686	48	4	10.01-06.04	Y17DTL		EPBMFT5-V017H	90311	EPBMFT5-V001P	93006
1.7 DTI 16V	1686	55	4	10.01-06.04	Y17DT		EPBMFT5-V017H	90311	EPBMFT5-V001P	93006
1.7 CDTI 16V	1686	74	4	07.04-01.11	Z17DTH		EPBMFT5-V010H	96310	EPBMFT5-V001P	93006

CORSA B (S93) | VITA

1.0 i 12V	973	40	3	11.96-09.00	X10XE		EPBMFT5-V007H	97257	EPBMFT5-V001P	93006
1.2 i 16V	1199	48	4	03.98-09.00	X12XE		EPBMFT5-V007H	97257	EPBMFT5-V001P	93006

CORSA C (X01)

1.0	973	43	3	09.00-06.03	Z10XE		EPBMFT5-V007H	97257	EPBMFT5-V001P	93006
1.0	998	44	3	06.03-09.06	Z10XEP		EPBMFT5-V007H	97257	EPBMFT5-V001P	93006
1.2	1199	55	4	09.00-06.04	Z12XE		EPBMFT5-V007H	97257	EPBMFT5-V001P	93006
1.2 16V	1199	55	4	09.00-07.03	Z12XE		EPBMFT5-V007H	97257	EPBMFT5-V001P	93006
1.2 Twinport	1229	59	4	07.04-09.06	Z12XEP		EPBMFT5-V007H	97257	EPBMFT5-V001P	93006
1.2	1229	59	4	07.05-06.06	Z12XEP		EPBMFT5-V007H	97257	EPBMFT5-V001P	93006
1.3 CDTI	1248	51	4	06.03-09.06	Z13DT		EPBMFT5-V010H	96310	EPBMFT5-V001P	93006
1.3 CDTI 16V	1248	51	4	07.05-06.06	Z13DT		EPBMFT5-V010H	96310	EPBMFT5-V001P	93006
1.4	1364	66	4	08.03-06.12	Z14XEP		EPBMFT5-V001P	93006		
1.4 Twinport	1364	66	4	06.03-09.06	Z14XEP		EPBMFT5-V007H	97257	EPBMFT5-V001P	93006
1.7 DI 16V	1686	48	4	09.00-07.03	Y17DTL		EPBMFT5-V017H	90311	EPBMFT5-V001P	93006
1.7 DI	1686	48	4	09.00-08.03	Y17DTL		EPBMFT5-V017H	90311	EPBMFT5-V001P	93006
1.7 DTI	1686	55	4	09.00-08.03	Y17DT		EPBMFT5-V001P	93006		
1.7 DTI 16V	1686	55	4	09.00-07.03	Y17DT		EPBMFT5-V017H	90311	EPBMFT5-V001P	93006
1.7 CDTI	1686	74	4	06.03-09.06	Z17DTH		EPBMFT5-V010H	96310	EPBMFT5-V001P	93006
1.8	1796	92	4	09.00-12.09	Z18XE		EPBMWT4-V002H	92668		

CORSA D (S07)

1.0	998	44	3	08.06-08.14	A10XEP		EPBMFT5-T001D	94095		
1.0	998	48	3	01.10-08.14	A10XEP		EPBMFT5-T001D	94095		
1.2	1229	51	4	01.10-08.14	A12XEL	; Without ECOFLEX	EPBMFT5-T001D	94095		
1.2 LPG	1229	61	4	06.11-08.14	A12XER		EPBMFT5-T001D	94095		
1.2	1229	63	4	06.10-08.14	A12XER	; Without ECOFLEX	EPBMFT5-T001D	94095		
1.3 CDTI	1248	55	4	07.06-08.14	Z13DTJ, A13DTC		EPBMFN4-V026H	94497		
1.3 CDTI	1248	55	4	07.06-08.14	Z13DTJ		EPBMFN4-V010H	97588		
1.3 CDTI	1248	66	4	07.06-06.10	Z13DTH		EPBMFN4-V026H	94497		
1.3 CDTI	1248	66	4	07.06-06.10	Z13DTH		EPBMFN4-V010H	97588		
1.3 CDTI	1248	70	4	06.09-08.14	A13DTE, Z13DTE, A13DTR		EPBMFT5-T011H	92630		
1.4	1364	66	4	07.06-08.14	Z14XEP		EPBMFT5-V001P	93006		
1.4	1398	64	4	09.09-08.14	A14XEL	; Without ECOFLEX	EPBMFT5-T001D	94095		
1.4	1398	74	4	12.09-08.14	A14XER	; Without ECOFLEX	EPBMFT5-T001D	94095		



MAF



l kW
C
Y
I



Type-N°

Stock-N°

Plug In
Alternative
Type-N°

Plug In
Stock-N°

OPEL

CORSA D (S07)

1.6 Turbo	1598	110	4	05.07-08.14	A16LEL, Z16LEL		EPBMFT5-V017H	90311	EPBMFT5-V001P	93006
1.6 Turbo	1598	141	4	11.06-08.14	A16LER, Z16LER		EPBMFT5-V017H	90311	EPBMFT5-V001P	93006
1.6 Turbo	1598	155	4	06.11-08.14	A16LES	; Ecotec	EPBMFT5-V017H	90311		
1.6 Turbo	1598	155	4	06.11-08.14	A16LES	; Ecotec	EPBMFT5-V001P	93006		
1.7 CDTI	1686	92	4	08.06-12.11	Z17DTR		EPBMFT5-V006H	94366		
1.7 CDTI	1686	96	4	07.12-08.14	A17DTS		EPBMFT5-T011H	92630		

CORSA E (X15)

1.3 CDTI	1248	55	4	01.15-	B13DTC, B13DTN		EPBMFT5-T001D	94095		
1.3 CDTI	1248	70	4	09.14-	B13DTE, B13DTR		EPBMFT5-T001D	94095		
1.4	1398	55	4	09.14-	B14XEJ	; Chass.>G4; Chass.>G6; Chass.Q	EPBMFT5-T001D	94095		
1.4 LPG	1398	64	4	11.15-	B14XEL		EPBMFT5-T001D	94095		
1.4	1398	66	4	09.14-	B14XEL	; Chass.>G4; Chass.>G6; Chass.Q	EPBMFT5-T001D	94095		
1.4 LPG	1398	66	4	03.15-	B14XEL	; Chass.>G4; Chass.>G6; Chass.Q	EPBMFT5-T001D	94095		
1.6 Turbo	1598	152	4	03.15-	B16LER, B16LES		EPBMFT5-T001D	94095		

FRONTERA B (U99)

2.2 DTI	2172	85	4	10.98-09.02	X22DTH, Y22DTH	; Chass.<2V599999	EPBMFT5-V008H	93715		
2.2 DTI	2172	88	4	09.02-07.04	Y22DTH		EPBMFT5-V001P	93006		
2.2 DTI	2172	88	4	09.02-07.04	Y22DTH	; Chass.<2V599999	EPBMFT5-V008H	93715		

INSIGNIA A (G09)

1.6	1598	85	4	07.08-03.17	A16XER		EPBMFT5-T011H	92630		
1.6 CDTi	1598	88	4	07.15-01.17	B16DTJ		EPBMFT5-T003H	91493		
1.6 CDTi	1598	100	4	07.15-03.17	B16DTH		EPBMFT5-T003H	91493		
1.6 Turbo	1598	132	4	01.09-06.13	A16LET		EPBMFT5-T003H	91493		
1.8	1796	103	4	07.08-03.17	A18XER, B18XER		EPBMFT5-T011H	92630		
2.0 CDTI	1956	81	4	07.08-03.17	A20DTC, A20DTL		EPBMFT5-T003H	91493		
2.0 CDTI	1956	88	4	03.12-03.17	A20DTE		EPBMFT5-T003H	91493		
2.0 CDTI	1956	96	4	07.08-03.17	A20DTJ, A20DT		EPBMFT5-T003H	91493		
2.0 CDTI	1956	103	4	06.13-03.17	A20DTE		EPBMFT5-T003H	91493		
2.0 CDTI	1956	118	4	07.08-03.17	A20DTH		EPBMFT5-T003H	91493		
2.0 CDTI 4x4	1956	118	4	06.10-03.17	A20DTH		EPBMFT5-T003H	91493		
2.0 CDTI	1956	120	4	07.13-03.17	A20DTH		EPBMFT5-T003H	91493		
2.0 CDTI 4x4	1956	120	4	07.13-03.17	A20DTH		EPBMFT5-T003H	91493		
2.0 CDTI	1956	125	4	11.14-03.17	B20DTH		EPBMFT5-T003H	91493		
2.0 CDTI 4x4	1956	125	4	11.14-03.17	B20DTH		EPBMFT5-T003H	91493		
2.0 Biturbo CDTI	1956	140	4	07.08-03.17	A20DTR		EPBMFT5-T003H	91493		
2.0 Biturbo CDTI 4x4	1956	140	4	05.09-12.11	A20DTR		EPBMFT5-T003H	91493		



MAF



l kW
C
Y
I



Type-Nº

Stock-Nº

Plug In
Alternative
Type-Nº

Plug In
Subtype

OPEL

INSIGNIA A (G09)

2.0 Biturbo CDTI	1956	143	4	01.12-03.17	A20DTR		EPBMFT5-T003H	91493		
2.0 Biturbo CDTI 4x4	1956	143	4	01.12-03.17	A20DTR		EPBMFT5-T003H	91493		
2.0 CDTi 4x4	1956	143	4	09.13-03.17	A20DTR		EPBMFT5-T003H	91493		

MERIVA A MPV (X03)

1.3 CDTI	1248	51	4	04.05-05.10	Z13DT, Y13DT		EPBMFT5-V022H	93863		
1.4 16V Twinport	1364	66	4	07.04-05.10	Z14XEP		EPBMFT5-V007H	97257	EPBMFT5-V001P	93006
1.4 16V Twinport LPG	1364	66	4	07.04-05.10	Z14XEP		EPBMFT5-V007H	97257	EPBMFT5-V001P	93006
1.6 Turbo	1598	132	4	09.05-05.10	Z16LET		EPBMFT5-V017H	90311	EPBMFT5-V001P	93006
1.7 DTI	1686	55	4	09.03-09.05	Y17DT		EPBMFT5-V001P	93006		
1.7 CDTI	1686	74	4	09.03-05.10	Z17DT, Z17DTH		EPBMFT5-V022H	93863		
1.7 CDTI	1686	74	4	09.03-05.10	Z17DT		EPBMFN5-V001D	95368		
1.7 CDTI	1686	92	4	09.06-05.10	Z17DTR		EPBMFN5-V001D	95368		
1.8	1796	92	4	05.03-05.10	Z18XE		EPBMWT4-V002H	92668		

MERIVA B MPV (S10)

1.3 CDTI	1248	55	4	06.10-10.13	A13DTC		EPBMFT5-T011H	92630		
1.3 CDTI	1248	70	4	06.10-11.14	A13DTE		EPBMFT5-T011H	92630		
1.4	1364	88	4	06.10-03.17	A14NEL, B14NEL		EPBMFT5-T011H	92630		
1.4 LPG	1364	88	4	06.11-03.17	A14NEL		EPBMFT5-T011H	92630		
1.4 LPG	1364	88	4	06.11-03.17	B14NEL		EPBMFT5-T011H	92630		
1.4	1364	103	4	06.10-03.17	A14NET, B14NET		EPBMFT5-T011H	92630		
1.4	1398	74	4	06.10-03.17	A14XER, B14XER		EPBMFT5-T001D	94095		
1.6 CDTI	1598	70	4	01.14-01.17	B16DTC		EPBMFT5-T001D	94095		
1.6 CDTI	1598	81	4	03.14-03.17	B16DTE, B16DTL, B16DTN		EPBMFT5-T001D	94095		
1.6 CDTi	1598	100	4	08.13-01.17	B16DTH		EPBMFT5-T001D	94095		
1.7 CDTI	1686	74	4	06.10-01.17	A17DT		EPBMFT5-T011H	92630		
1.7 CDTI	1686	81	4	06.10-06.15	A17DTC, A17DTI		EPBMFT5-T011H	92630		
1.7 CDTI	1686	96	4	06.10-10.13	A17DTS		EPBMFT5-T011H	92630		

MOKKA / MOKKA X (J13)

1.8	1796	103	4	01.13-	A18XER		EPBMFT5-T001D	94095		
1.8 4x4	1796	103	4	01.13-	A18XER		EPBMFT5-T001D	94095		

MOVANO (X70)

1.9 DTI	1870	59	4	09.00-10.01	F9Q770		EPBMWT6-A001H	90144		
1.9 DTI	1870	60	4	10.01-	F9Q772, F9Q774		EPBMFT6-A044H	92490		
1.9 DTI	1870	60	4	-12.10	F9Q774		EPBMWT6-A001H	90144		
2.2 DTI	2188	66	4	09.00-	G9T720, G9T722, G9T750		EPBMFT6-A044H	92490		
2.5 DTI	2463	84	4	10.01-	G9U720, G9U724, G9U750, G9U754		EPBMFT6-A044H	92490		
2.5 CDTI	2464	74	4	08.06-	G9U650		EPBMWT6-A007H	93605		
2.5 CDTI	2464	88	4	08.06-	G9U632, G9U650		EPBMWT6-A007H	93605		



MAF

 l kW
C
Y
I

Type-Nº

Stock-Nº

 Plug In
Alternative
Type-Nº

 Plug In
Subtype

OPEL
MOVANO (X70)

2.5 CDTI	2464	107	4	08.06-	G9U632, G9U650		EPBMWT6-A007H	93605		
----------	------	-----	---	--------	----------------	--	---------------	-------	--	--

OMEGA B (V94)

2.0 DTI 16V	1995	74	4	09.97-09.00	X20DTH		EPBMFT5-V017H	90311	EPBMFT5-V001P	93006
2.0 16V	1998	100	4	03.94-09.99	X20XE		EPBMWN4-A019H	92343		
2.2 DTI 16V	2172	81	4	09.00-07.03	Y22DTH		EPBMFT5-V017H	90311	EPBMFT5-V001P	93006
2.2 DTI 16V	2172	88	4	09.00-07.03	Y22DTH		EPBMFT5-V001P	93006		
2.2 16V	2198	106	4	09.99-07.03	Z22XE, Y22XE		EPBMWT4-V002H	92668		
2.5 D	2497	96	6	05.94-05.99	X25TD		EPBMFN6-R030H	90274		
2.5 TD	2497	96	6	04.94-07.01	X25TD		EPBMFN6-R030H	90274		
2.6 V6	2597	132	6	09.00-07.03	Y26SE		EPBMFT5-V008H	93715		
3.2 V6	3175	160	6	02.01-07.03	Y32SE		EPBMFT5-V008H	93715		

SIGNUM HATCHBACK (Z03)

1.8	1796	90	4	05.03-07.05	Z18XE		EPBMWT4-V002H	92668		
1.8	1796	103	4	09.05-12.08	Z18XER		EPBMFT4-V048H	95493		
1.9 CDTI	1910	74	4	08.05-02.08	Z19DTL		EPBMFN4-V026H	94497		
1.9 CDTI	1910	74	4	08.05-02.08	Z19DTL		EPBMFN4-V010H	97588		
1.9 CDTI	1910	88	4	04.04-02.08	Z19DT		EPBMFN4-V026H	94497		
1.9 CDTI	1910	88	4	04.04-02.08	Z19DT		EPBMFN4-V010H	97588		
1.9 CDTI	1910	110	4	04.04-02.08	Z19DTH		EPBMFN4-V026H	94497		
1.9 CDTI	1910	110	4	04.04-02.08	Z19DTH		EPBMFN4-V010H	97588		
2.0 DTI	1995	74	4	05.03-04.04	Y20DTH		EPBMFT5-V001P	93006		
2.2 DTI	2172	92	4	05.03-04.04	Y22DTR		EPBMFT5-V001P	93006		
2.2 direct	2198	114	4	05.03-09.08	Z22YH		EPBMWT5-V021H	97091		
3.0 V6 CDTI	2959	135	6	09.05-09.08	Z30DT		EPBMFT5-V001P	93006		
3.2 V6	3175	155	6	05.03-07.05	Z32SE		EPBMFT5-V035H	94119		

SINTRA (APV)

2.2 DTI	2171	85	4	07.97-04.99	X22DTH		EPBMFT5-V008H	93715		
---------	------	----	---	-------------	--------	--	---------------	-------	--	--

SPEEDSTER (E01)

2.0 Turbo	1998	147	4	08.02-08.06	Z20LET		EPBMFT5-V017H	90311	EPBMFT5-V001P	93006
-----------	------	-----	---	-------------	--------	--	---------------	-------	---------------	-------

TIGRA TWINTOP (X04)

1.3 CDTI	1248	51	4	06.04-03.09	Z13DT		EPBMFT5-V010H	96310	EPBMFT5-V001P	93006
1.4	1364	66	4	06.04-12.09	Z14XEP		EPBMFT5-V007H	97257	EPBMFT5-V001P	93006
1.8	1796	92	4	06.04-12.10	Z18XE		EPBMWT4-V002H	92668		

VECTRA A (J89)

2.0 i 16V	1998	100	4	08.92-08.95	X20XE		EPBMWN4-A019H	92343		
2.0 i 16V 4x4	1998	100	4	06.94-11.95	X20XE		EPBMWN4-A019H	92343		

VECTRA B (J96)

1.8 i 16V	1796	85	4	10.95-09.00	Z18XEL, X18XE1		EPBMWT4-V002H	92668		
1.8 i 16V	1796	92	4	09.00-04.02	Z18XE		EPBMWT4-V002H	92668		
1.8 i 16V	1799	85	4	10.95-09.00	X18XE		EPBMWN4-A019H	92343		



MAF



l kW
C
y
i



Type-N°

Stock-N°

Plug In
Alternative
Type-N°

Plug In
Subtype

OPEL

VECTRA B (J96)

2.0 DI 16V	1995	60	4	11.96-04.02	X20DTL	; Chass.>W1000001	EPBMFT5-V017H	90311	EPBMFT5-V001P	93006
2.0 DTI 16V	1995	74	4	06.97-04.02	X20DTH		EPBMFT5-V017H	90311	EPBMFT5-V001P	93006
2.0 i 16V	1998	100	4	10.95-06.00	C20SEL, X20XEV		EPBMWN4-A019H	92343		
2.2 DTI 16V	2172	88	4	09.00-04.02	Y22DTR		EPBMFT5-V017H	90311		
2.2 DTI 16V	2172	92	4	09.00-04.02	Y22DTR		EPBMFT5-V017H	90311		
2.2 DTI 16V	2172	92	4	09.00-04.02	Y22DTR		EPBMFT5-V001P	93006		
2.6 i V6	2597	125	6	09.00-04.02	Y26SE		EPBMFT5-V008H	93715		

VECTRA C (Z02)

1.8	1796	81	4	04.02-07.08	Z18XEL		EPBMWT4-V002H	92668		
1.8 16V	1796	81	4	08.02-12.06	Z18XEL		EPBMWT4-V002H	92668		
1.8 16V	1796	90	4	04.02-09.08	Z18XE		EPBMWT4-V002H	92668		
1.8	1796	90	4	10.03-09.06	Z18XE		EPBMWT4-V002H	92668		
1.8	1796	103	4	08.05-08.08	Z18XER		EPBMFT4-V048H	95493		
1.9 CDTI	1910	74	4	06.05-08.08	Z19DTL		EPBMFN4-V026H	94497		
1.9 CDTI	1910	74	4	06.05-08.08	Z19DTL		EPBMFN4-V010H	97588		
1.9 CDTI	1910	88	4	04.04-01.09	Z19DT		EPBMFN4-V026H	94497		
1.9 CDTI	1910	88	4	04.04-01.09	Z19DT		EPBMFN4-V010H	97588		
1.9 CDTI	1910	110	4	04.04-08.08	Z19DTH		EPBMFN4-V026H	94497		
1.9 CDTI	1910	110	4	04.04-08.08	Z19DTH		EPBMFN4-V010H	97588		
2.0 DTI 16V	1995	74	4	08.02-08.05	Y20DTH, Y22DTR		EPBMFT5-V019H	96039	EPBMFT5-V001P	93006
2.0 DTI 16V	1995	74	4	04.02-08.06	Y20DTH		EPBMFT5-V019H	96039	EPBMFT5-V001P	93006
2.0 DTI	1995	74	4	10.03-08.05	Y20DTH		EPBMFT5-V001P	93006		
2.2 DTI 16V	2172	86	4	04.02-12.04	Y22DTR		EPBMFT5-V019H	96039		
2.2 DTI 16V	2172	92	4	04.02-07.04	Y22DTR		EPBMFT5-V019H	96039	EPBMFT5-V001P	93006
2.2 DTI	2172	92	4	10.03-09.05	Y22DTR		EPBMFT5-V001P	93006		
2.2 16V	2198	108	4	04.02-12.08	Z22SE	; Chass.>41000001	EPBMWT5-V023H	95103		
2.2 DGi	2198	114	4	10.03-08.08	Z22YH		EPBMWT5-V021H	97091		
2.2 direct	2198	114	4	10.03-08.08	Z22YH		EPBMWT5-V021H	97091		
3.0 V6 CDTI	2959	135	6	08.05-08.08	Z30DT		EPBMFT5-V001P	93006		

VIVARO A (X83)

1.9 DI	1870	60	4	08.01-	F9Q762		EPBMWT6-A001H	90144		
1.9 DTI	1870	74	4	08.01-	F9Q760		EPBMWT6-A001H	90144		
2.0 CDTI	1995	66	4	01.06-	M9R630, M9R692		EPBMWT4-A019H	94808		
2.0 CDTI	1995	66	4	08.06-	M9R780, M9R782, M9R786		EPBMWT6-A007H	93605		
2.0 CDTI	1995	84	4	08.06-	M9R630		EPBMWT4-A019H	94808		
2.0 CDTI	1995	84	4	08.06-	M9R630, M9R692		EPBMWT4-A019H	94808		
2.0 CDTI	1995	84	4	08.06-	M9R786, M9R788, M9R780, M9R784		EPBMWT6-A007H	93605		
2.5 DTI	2463	99	4	05.03-	G9U730		EPBMWT6-A001H	90144		



MAF



l kW
C
Y
I



Type-N°

Stock-N°

Plug In
Alternative
Type-N°

Plug In
Stock-N°

OPEL

VIVARO A (X83)

2.5 CDTI	2463	107	4	08.06-	G9U630		EPBMWT6-A007H	93605		
2.5 CDTI	2464	84	4	08.06-	G9U630		EPBMWT6-A001H	90144		

ZAFIRA A MPV (T98)

1.6 16V	1598	74	4	04.99-06.05	Z16XE		EPBMWT5-V010H	93933		
1.8 16V	1796	85	4	04.99-09.00	X18XE1		EPBMWT4-V002H	92668		
2.0 DI 16V	1995	60	4	07.99-08.00	X20DTL		EPBMFT5-V001P	93006		
2.0 DI 16V	1995	60	4	-08.00	X20DTL	; Chass.1T000001; Chass.>12000001	EPBMFT5-V017H	90311		
2.0 DI	1995	63	4	07.99-06.00	X20DTL		EPBMFT5-V017H	90311		
2.0 DTI 16V	1995	74	4	09.00-06.05	Y20DTH		EPBMFT5-V001P	93006		
2.0 DTI 16V	1995	74	4	09.00-06.05	Y20DTH	; Chass.18000001; Chass.>1H000001; Chass.>16000001; Chass.>12000001; Chass.>15000001; Chass.<2H999999; Chass.<26999999; Chass.<22999999; Chass.<25999999	EPBMFT5-V017H	90311		
2.0 DTI 16V	1995	74	4	09.00-06.05	Y20DTH	; Chass.>38000001; Chass.>3H000001; Chass.>36000001; Chass.>32000001; Chass.>35000001	EPBMFT5-V010H	96310		
2.0 OPC	1998	141	4	09.01-06.05	Z20LET		EPBMFT5-V017H	90311	EPBMFT5-V001P	93006
2.0 OPC	1998	147	4	11.02-06.05	Z20LET		EPBMFT5-V017H	90311	EPBMFT5-V001P	93006

ZAFIRA B (A05)

1.6	1598	77	4	07.05-09.12	Z16XE1, Z16XEP	; Chass.<6G999999; Chass.<62999999	EPBMWT5-V010H	93933		
1.7 CDTI	1686	81	4	01.08-04.15	A17DTJ, Z17DTJ		EPBMFT5-V006H	94366		
1.7 CDTI	1686	92	4	01.08-04.15	A17DTR		EPBMFT5-V006H	94366		
1.8	1796	103	4	07.05-04.15	A18XER, Z18XER		EPBMFT4-V048H	95493		
1.9 CDTI	1910	74	4	07.05-12.10	Z19DTL		EPBMWN3-V009H	96875		
1.9 CDTI	1910	88	4	07.05-04.15	Z19DT	Type:Van	EPBMWN3-V009H	96875		
1.9 CDTI	1910	110	4	07.05-04.15	Z19DTH	Type:Van	EPBMWN3-V009H	96875		
2.0	1998	147	4	07.05-12.10	Z20LER		EPBMFT5-V017H	90311	EPBMFT5-V001P	93006
2.2	2198	110	4	07.05-12.12	Z22YH		EPBMWT5-V021H	97091		

ZAFIRA TOURER C (P12)

1.4	1364	88	4	10.11-	A14NEL, B14NEL		EPBMFT5-T001D	94095		
1.4	1364	103	4	10.11-	A14NET, B14NET		EPBMFT5-T001D	94095		
1.4 LPG	1364	103	4	10.11-	A14NET, B14NET		EPBMFT5-T001D	94095		
1.6 CDTI	1598	88	4	07.14-	B16DTJ, D16DTJ		EPBMFT5-T001D	94095		
1.6 CDTI	1598	99	4	11.16-	B16DTH, D16DTH		EPBMFT5-T001D	94095		
1.6 CDTI	1598	100	4	02.13-	B16DTH		EPBMFT5-T001D	94095		
1.6 CNG	1598	110	4	10.11-	A16XNT, B16XNT		EPBMFT5-T001D	94095		



MAF



l kW
C
y
I



Type-N°

Stock-N°

Plug In
Alternative
Type-N°

Plug In
Subtype

OPEL

ZAFIRA TOURER C (P12)

1.8	1796	85	4	10.11-	A18XEL		EPBMFT5-T001D	94095		
1.8	1796	103	4	10.11-	A18XER		EPBMFT5-T001D	94095		
2.0 CDTi	1956	81	4	10.11-	A20DTL		EPBMFT5-T003H	91493		
2.0 CDTi	1956	96	4	10.11-	A20DT, Y20DTJ, Z20DTJ		EPBMFT5-T003H	91493		
2.0 CDTi	1956	121	4	10.11-	A20DTH		EPBMFT5-T003H	91493		
2.0 CDTi	1956	125	4	01.15-	B20DTH, D20DTH		EPBMFT5-T001D	94095		
2.0 BiTurbo CDTI	1956	143	4	01.13-	A20DTR		EPBMFT5-T003H	91493		

PEUGEOT

1007 (KM_)

1.4 HDi	1398	50	4	04.05-09.06	8HX, 8HZ		EPBMWT6-A006H	94034		
1.4 HDi	1398	50	4	04.05-	8HX, 8HZ	; Euro4	EPBMWT4-A009H	92423		
1.6 HDi	1560	80	4	07.07-	9HZ		EPBMFT5-A001H	93740		

107 (PM_, PN_)

1.4 HDi	1398	40	4	06.05-05.14	8HT		EPBMWT4-A009H	92423		
---------	------	----	---	-------------	-----	--	---------------	-------	--	--

2008 I (CU_)

1.4 HDi	1398	50	4	06.13-	8HR		EPBMWT4-A026H	95537		
1.6 HDi	1560	68	4	03.13-	9HP		EPBMWT4-A026H	95537		
1.6 HDi	1560	84	4	03.13-	9HD	; RPO>1310088	EPBMWT4-A026H	95537		

206 CC (2D)

1.6 HDi 110	1560	80	4	04.05-02.07	9HZ		EPBMFT5-A001H	93740		
-------------	------	----	---	-------------	-----	--	---------------	-------	--	--

206 / 206 SW (2A/C, 2E/K)

1.4 HDi eco 70	1398	50	4	09.01-04.09	8HX, 8HZ	; Euro4	EPBMWT4-A009H	92423		
1.4 HDi	1398	50	4	07.02-	8HX		EPBMWT6-A006H	94034		
1.4 HDi	1398	51	4	09.02-12.05	8HX		EPBMWT6-A006H	94034		
1.6 HDi 110	1560	80	4	05.04-02.07	9HY, 9HZ		EPBMFT5-A001H	93740		
2.0 HDi 90	1997	66	4	12.99-09.09	RHY		EPBMWT5-A004H	91200		
2.0 HDi	1997	66	4	07.02-	DW10TD		EPBMWT5-A004H	91200		

206+ (2L_, 2M_)

1.4 HDi eco 70	1398	50	4	01.09-06.13	8HR, 8HZ		EPBMWT4-A026H	95537		
1.4 HDi eco 70	1398	50	4	01.09-06.13	8HZ		EPBMWT4-A009H	92423		

207 / 207 SW (WK_, WA_, WC_, WD_)

1.4 HDi	1398	50	4	02.06-12.15	8HR, 8HZ		EPBMWT4-A026H	95537		
1.4 HDi	1398	50	4	02.06-12.15	8HZ, 8HR		EPBMWT4-A009H	92423		
1.6 HDi	1560	66	4	02.06-10.13	9HV, 9HX		EPBMFT5-A001H	93740		
1.6 HDi	1560	68	4	11.09-	9HP		EPBMWT4-A026H	95537		
1.6 HDi	1560	80	4	02.06-01.15	9HY, 9HZ		EPBMFT5-A001H	93740		
1.6 HDi	1560	82	4	08.09-10.13	9HR		EPBMWT4-A026H	95537		
1.6 HDi 110	1560	82	4	08.09-12.12	9HR		EPBMWT4-A026H	95537		



MAF

 l kW
C
Y
I

Type-N°

Stock-N°

 Plug In
Alternative
Type-N°

 Plug In
Subtype

PEUGEOT
208 I (CA_, CC_)

1.4 HDi	1398	50	4	03.12-	8HP, 8HR		EPBMWT4-A026H	95537		
1.6 HDi / BlueHDi 75	1560	55	4	01.13-	9HK		EPBMWT4-A026H	95537		
1.6 HDi	1560	68	4	03.12-	9HJ, 9HP		EPBMWT4-A026H	95537		
1.6 HDi	1560	69	4	09.16-	9HP		EPBMWT4-A026H	95537		
1.6 HDi	1560	84	4	03.12-	9HD		EPBMWT4-A026H	95537		

208 KASTEN (CR_)

1.4 HDi	1398	50	4	10.12-	8HR		EPBMWT4-A026H	95537		
1.6 HDi	1560	68	4	03.14-	9HP		EPBMWT4-A026H	95537		

3008 (OU_)

1.6 HDi	1560	80	4	06.09-08.16	9HZ		EPBMFT5-A001H	93740		
1.6 HDi	1560	82	4	12.09-08.16	9HR		EPBMWT4-A026H	95537		
1.6 HDi	1560	84	4	03.13-08.16	9HD		EPBMWT4-A026H	95537		
1.6 HDi 115 / BlueHDi 115	1560	85	4	02.13-08.16	9HC		EPBMWT4-A026H	95537		
2.0 HDi 150 / BlueHDi 150	1997	110	4	06.09-08.16	AHX, RHE		EPBMWN4-A024H	90997		
2.0 HDi 150 / BlueHDi 150	1997	110	4	06.09-08.16	AHX, RHE	; ; ; ; for cold climates; RPO>12572; RPO12747; RPO<12571	EPBMWT4-A028H	91236		
2.0 HDi 150 / BlueHDi 150	1997	110	4	06.09-08.16	RHE		EPBMWT4-A011H	90069		
2.0 HDi	1997	120	4	06.09-08.16	RHH	; ; ; ; for cold climates; RPO>12572; RPO12747; RPO<12751	EPBMWT4-A028H	91236		
2.0 HDi Hybrid4	1997	120	4	02.11-08.16	RHC	; ; ; ; for cold climates; RPO>12572; RPO12747; RPO<12751	EPBMWT4-A028H	91236		
2.0 HDi Hybrid4	1997	120	4	04.11-	RHC	; RPO>12572, Not for cold climates	EPBMWT4-A011H	90069		
2.0 HDi Hybrid4	1997	147	4	04.11-	RHC	; RPO>12572, Not for cold climates	EPBMWT4-A011H	90069		

301

1.6 HDi 90	1560	68	4	11.12-	9HF, 9HJ		EPBMWT4-A026H	95537		
------------	------	----	---	--------	----------	--	---------------	-------	--	--

306 (7A, 7B, 7E N3, N5)

1.9 D	1868	51	4	09.98-04.02	WJY, WJZ		EPBMWT5-A004H	91200		
2.0 HDi 90	1997	66	4	06.99-04.02	RHY		EPBMWT5-A003H	93842		

307 / 307 SW (3A/C, 3B, 3E, 3H)

1.4 HDi	1398	50	4	03.02-06.05	8HX, 8HZ		EPBMWT6-A006H	94034		
1.6 HDi	1560	66	4	06.05-03.09	9HV, 9HX		EPBMFT5-A001H	93740		
1.6 HDi 90	1560	66	4	04.05-04.08	9HV, 9HX		EPBMFT5-A001H	93740		
1.6 HDi 110	1560	80	4	04.04-03.09	9HY, 9HZ		EPBMFT5-A001H	93740		
2.0 HDi 90	1997	66	4	03.02-06.02	RHY		EPBMWT5-A004H	91200		
2.0 HDi 90	1997	66	4	03.02-04.08	RHY		EPBMWT5-A003H	93842		
2.0 HDi 110	1997	79	4	03.02-12.09	RHS		EPBMWT5-A003H	93842		



MAF



l kW
C
Y
I



Type-N°

Stock-N°

Plug In
Alternative
Type-N°

Plug In
Subtype

PEUGEOT

307 / 307 SW (3A/C, 3B, 3E, 3H)

2.0 HDi	1997	100	4	04.04-11.07	RHR		EPBMWT4-A011H	90069		
2.0 HDi 135	1997	100	4	02.04-04.08	RHR		EPBMWT4-A011H	90069		

308 / 308 SW (4A_, 4B_, 4C_, 4E_, 4H_)

1.6 HDi	1560	66	4	09.07-10.14	9HV, 9HX		EPBMFT5-A001H	93740		
1.6 HDi	1560	68	4	11.09-10.14	9HJ, 9HP		EPBMWT4-A026H	95537		
1.6 HDi	1560	80	4	09.07-10.14	9HZ		EPBMFT5-A001H	93740		
1.6 HDi	1560	82	4	12.09-10.14	9HR		EPBMFT5-A001H	93740		
1.6 HDi	1560	82	4	06.09-12.14	9HR		EPBMWT4-A026H	95537		
1.6 HDi	1560	84	4	03.13-10.14	9HD		EPBMWT4-A026H	95537		
2.0 HDi	1997	100	4	01.08-12.11	RHR		EPBMWT4-A011H	90069		
2.0 HDi	1997	100	4	04.09-12.14	RHR		EPBMWT4-A008H	90627		
2.0 HDi	1997	103	4	04.09-12.12	RHF, RHR		EPBMWT4-A011H	90069		
2.0 HDi	1997	103	4	04.09-12.12	RHF, RHR		EPBMWT4-A008H	90627		
2.0 HDi	1997	110	4	04.11-10.14	RHE	; Not for cold climates	EPBMWT4-A011H	90069		
2.0 HDi	1997	110	4	04.11-10.14	RHE	; ; for cold climates; RPO12576; RPO12747	EPBMWT4-A028H	91236		
2.0 HDi	1997	120	4	04.12-10.14	RHH	; ; for cold climates; RPO12576; RPO12747	EPBMWT4-A028H	91236		
2.0 HDi	1997	120	4	04.12-10.14	RHH	; RPO>12576, Not for cold climates	EPBMWT4-A011H	90069		

308 II / 308 SW II

1.6 HDi	1560	68	4	09.13-	9HP		EPBMWT4-A026H	95537		
1.6 HDi / BlueHDi 115	1560	85	4	09.13-	9HC		EPBMWT4-A026H	95537		
1.6 e-HDi 115	1560	85	4	03.15-	9HC		EPBMWT4-A026H	95537		
2.0 BlueHDi 150	1997	110	4	11.13-	AHX		EPBMWT4-A028H	91236		
2.0 GT BlueHDi 180	1997	133	4	06.14-	AHW		EPBMWT4-A028H	91236		

4007 (VU_, VV_)

2.2 HDi	2179	115	4	07.07-03.13	4HK, 4HN		EPBMWT4-A008H	90627		
---------	------	-----	---	-------------	----------	--	---------------	-------	--	--

4008

1.6 HDi	1560	84	4	05.12-	9HD		EPBMWT4-A026H	95537		
1.6 HDi AWC	1560	84	4	05.12-	9HD		EPBMWT4-A026H	95537		

406 / 406 SW (8B, 8E/F, 8C)

2.0 HDi 90	1997	66	4	02.99-05.04	RHY		EPBMWT5-A003H	93842		
2.0 HDi 110	1997	79	4	08.01-05.04	RHS, RHZ		EPBMWT5-A003H	93842		
2.0 HDi 110	1997	80	4	02.99-04.04	RHZ		EPBMWT5-A003H	93842		
2.2 HDi	2179	98	4	03.00-05.04	4HX		EPBMWT5-A005H	93383		

407 / 407 SW (6C_, 6D_, 6E_)

1.6 HDi 110	1560	80	4	05.04-12.10	9HZ		EPBMFT5-A001H	93740		
2.0 HDi 135	1997	100	4	05.04-10.10	RHR		EPBMWT4-A008H	90627		



MAF



l kW
C
Y
I



Type-N°

Stock-N°

Plug In
Alternative
Type-N°

Plug In
Subtype

PEUGEOT

407 / 407 SW (6C_, 6D_, 6E_)

2.0 HDi	1997	100	4	10.05-	RHR		EPBMWT4-A008H	90627		
2.0 HDi	1997	103	4	06.09-12.10	RHR		EPBMWT4-A008H	90627		
2.0 HDi	1997	120	4	06.09-	RHH		EPBMWT4-A008H	90627		
2.0 HDi	1997	120	4	06.09-	RHH	; ; ; RPO<12578	EPBMWN4-A024H	90997		
2.7 HDi	2720	150	6	10.05-	UHZ		EPBMWT4-A011H	90069		
3.0 HDi	2992	177	6	06.09-	DT20C		EPBMWT4-A028H	91236		

5008 (0U_, 0E_)

1.6 HDi	1560	80	4	11.09-03.17	9HZ		EPBMFT5-A001H	93740		
1.6 HDi	1560	82	4	08.10-03.17	9HR		EPBMWT4-A026H	95537		
1.6 HDi	1560	84	4	03.13-03.17	9HD		EPBMWT4-A026H	95537		
2.0 HDi 136 / BlueHDi 136	1997	100	4	02.12-03.17	AHV, RHD	; ; for cold climates; RPO>12572; RPO<12747	EPBMWT4-A028H	91236		
2.0 HDi 136 / BlueHDi 136	1997	100	4	02.12-03.17	RHD		EPBMWT4-A011H	90069		
2.0 HDi 150 / BlueHDi 150	1997	110	4	06.09-03.17	AHR, AHX, RHE	; ; for cold climates; RPO>12572; RPO12747	EPBMWT4-A028H	91236		
2.0 HDi 150 / BlueHDi 150	1997	110	4	06.09-03.17	RHE		EPBMWT4-A011H	90069		
2.0 HDi	1997	120	4	09.09-03.17	RHH	; ; RPO>12747	EPBMWT4-A028H	91236		

508 I/ SW I (8D_8E_)

1.6 HDi	1560	82	4	11.10-12.18	9HL, 9HR		EPBMWT4-A026H	95537		
1.6 HDi	1560	84	4	02.12-12.18	9HD, 9HL, 9HR		EPBMWT4-A026H	95537		
2.0 HDi	1997	100	4	11.10-12.18	RHR		EPBMWT4-A008H	90627		
2.0 HDi	1997	103	4	11.10-12.18	RHA, RHF		EPBMWT4-A008H	90627		
2.0 BlueHDi 150	1997	110	4	04.14-12.18	AHX		EPBMWN4-A024H	90997		
2.0 HDi	1997	120	4	11.10-12.18	RHH	; ; ; BVM6; RPO<12571	EPBMWN4-A024H	90997		
2.0 HDi Hybrid4 AWC	1997	120	4	11.10-12.18	RHC	; ; BVM6; RPO12845; Transmission Type: BVM6	EPBMWN4-A024H	90997		
2.0 HDi RXH Hybrid4	1997	120	4	11.10-12.18	RHC	; ;	EPBMWN4-A024H	90997		
2.0 HDi RXH Hybrid4	1997	120	4	11.10-12.18	RHC	; ; ; RPO<12571	EPBMWN4-A024H	90997		
2.0 HDi RXH Hybrid4	1997	120	4	11.10-12.18	RHC	; ; Transmission Type: BVM6; RPO>12845	EPBMWN4-A024H	90997		
2.0 BlueHDi 180	1997	133	4	04.14-12.18	AHW		EPBMWN4-A024H	90997		
2.2 HDi	2179	150	4	11.10-12.18	4HL	;	EPBMWN4-A024H	90997		

607 (9D, 9U)

2.0 HDi	1997	79	4	03.01-09.04	DW10ATED		EPBMWT5-A005H	93383		
2.0 HDI	1997	80	4	05.00-09.05	RHZ		EPBMWT5-A005H	93383		
2.0 HDI	1997	100	4	09.05-07.11	RHR		EPBMWT4-A008H	90627		



MAF



l kW
C
Y
I



Type-N°

Stock-N°

Plug In
Alternative
Type-N°

Plug In
Subtype

PEUGEOT

607 (9D, 9U)

2.2 HDi	2179	98	4	02.00-02.06	4HX		EPBMWT5-A005H	93383		
2.2 HDi	2179	125	4	05.06-06.10	4HT		EPBMWT4-A008H	90627		
2.7 HDi 24V	2721	150	6	12.04-07.11	DT17TED4		EPBMWT4-A011H	90069		

806 (221)

2.0 HDi	1997	80	4	08.99-08.02	RHZ		EPBMWT5-A003H	93842		
2.0 HDi 16V	1997	80	4	08.99-08.02	DW10ATED4		EPBMWT5-A003H	93842		

807 (EB_)

2.0 HDi	1997	79	4	06.02-	RHW		EPBMWT5-A005H	93383		
2.0 HDi	1997	80	4	04.04-	RHW		EPBMWT5-A005H	93383		
2.0 HDi	1997	88	4	02.06-	RHK		EPBMWT4-A008H	90627		
2.0 HDi	1997	100	4	06.06-	RHD, RHR		EPBMWT4-A008H	90627		
2.0 HDi	1997	120	4	06.09-	RHH		EPBMWN4-A024H	90997		
2.2 HDi	2179	94	4	06.02-	4HW		EPBMWT5-A005H	93383		
2.2 HDi	2179	100	4	04.04-	4HW		EPBMWT5-A005H	93383		
2.2 HDi	2179	125	4	06.06-	4HT		EPBMWT4-A008H	90627		

BIPPER (AA_)

1.3 HDi 75	1248	55	4	10.10-	FHZ		EPBMFT4-V004H	90957		
1.3 HDi 80	1248	59	4	12.15-	FHY		EPBMFT4-V004H	90957		
1.3 HDi 80 / BlueHDi 80	1248	59	4	12.15-	FHY		EPBMFT4-V004H	90957		
1.4 HDi	1398	50	4	02.08-	8HS		EPBMWT4-A009H	92423		

BOXER

2.2 HDi 100	2198	74	4	04.06-	4HV		EPBMWT4-A001D	95860		
2.2 HDi 110	2198	81	4	03.11-	4HG		EPBMWT4-V003D	94395		
2.2 HDi 120	2198	88	4	04.06-	4HU		EPBMWT4-A001D	95860		
2.2 HDi 130	2198	96	4	03.11-	PUMA22DT		EPBMWT4-A001D	95860		
2.2 HDi 130	2198	96	4	03.11-	PUMAC96EURO5		EPBMWT4-V003D	94395		
2.2 HDi 150	2198	110	4	03.11-	4HJ		EPBMWT4-V003D	94395		
3.0 HDi 145	2999	107	4	04.10-	F1CE3481N		EPBMFT4-V061H	94528		
3.0 HDi	2999	115	4	02.07-	F1CE0481D	; Euro5	EPBMFT4-V061H	94528		
3.0 HDi	2999	115	4	02.07-	F1CE0481D	Not for Euro5	EPBMFN4-V020H	90971		
3.0 HDi 160	2999	116	4	04.06-	F1CE0481D	; Euro5	EPBMFT4-V061H	94528		
3.0 HDi 160	2999	116	4	04.06-	F1CE0481D	Not for Euro5	EPBMFN4-V020H	90971		
3.0 HDi 175	2999	130	4	03.11-	F1CE3481E		EPBMFT4-V061H	94528		

BOXER (244, Z_)

2.0 HDi	1997	62	4	04.02-	RHV		EPBMWT5-A004H	91200		
2.2 HDi	2179	74	4	04.02-	4HY		EPBMWT5-A004H	91200		
2.8 HDi	2798	94	4	04.02-	814043S		EPBMFT5-V008H	93715		
2.8 HDi 4x4	2798	94	4	04.02-	814043S		EPBMFT5-V008H	93715		
2.8 HDi	2798	107	4	04.04-	814043N		EPBMFT5-V008H	93715		



MAF



l kW
C
Y
I



Type-N°

Stock-N°

Plug In
Alternative
Type-N°

Plug In
Subtype

PEUGEOT

BOXER (ZCT_)

2.8 HDi	2798	93	4	10.00-11.01	814043S	; for engines with EGR	EPBMFT5-V008H	93715		
2.8 HDi All-wheel Drive	2798	93	4	10.00-11.01	814043S	; for engines with EGR	EPBMFT5-V008H	93715		
2.8 HDi	2798	94	4	11.00-04.02	814043S	; for engines with EGR	EPBMFT5-V008H	93715		

BOXER BUS (230P)

2.8 HDi	2798	93	4	10.00-11.01	814043S	; for engines with EGR	EPBMFT5-V008H	93715		
2.8 HDi All-wheel Drive	2798	93	4	10.00-11.01	814043S	; for engines with EGR	EPBMFT5-V008H	93715		
2.8 HDi	2798	94	4	11.00-04.02	814043S	; for engines with EGR	EPBMFT5-V008H	93715		
2.8 HDi 4x4	2798	94	4	10.00-04.02	814043S	; for engines with EGR	EPBMFT5-V008H	93715		

BOXER VAN (230L)

2.8 HDi	2798	93	4	10.00-11.01	814043S	; for engines with EGR	EPBMFT5-V008H	93715		
2.8 HDi 4x4	2798	93	4	10.00-11.01	814043S	; for engines with EGR	EPBMFT5-V008H	93715		
2.8 HDi	2798	94	4	11.00-04.02	814043S	; for engines with EGR	EPBMFT5-V008H	93715		
2.8 HDi 4x4	2798	94	4	10.00-04.02	814043S	; for engines with EGR	EPBMFT5-V008H	93715		

BOXER VAN (244)

2.0 HDi	1997	62	4	04.02-	RHV		EPBMWT5-A004H	91200		
2.2 HDi	2179	74	4	04.02-	4HY		EPBMWT5-A004H	91200		
2.8 HDi	2798	93	4	09.05-09.09	814043S	; for engines with EGR	EPBMFT5-V008H	93715		
2.8 HDi	2798	94	4	04.02-	814043S		EPBMFT5-V008H	93715		
2.8 HDi 4x4	2798	94	4	04.02-	814043S		EPBMFT5-V008H	93715		
2.8 HDi	2798	107	4	04.04-	814043N		EPBMFT5-V008H	93715		

EXPERT

1.6 HDi 90 16V	1560	66	4	01.07-	9HU		EPBMFT5-A001H	93740		
1.6 HDi 90 8V	1560	66	4	01.07-	9HH, 9HM		EPBMWT4-A026H	95537		
2.0 HDi 120	1997	88	4	01.07-	RHK		EPBMWT4-A008H	90627		
2.0 HDi 130	1997	94	4	03.11-	AHZ		EPBMWN4-A024H	90997		
2.0 HDi 165	1997	120	4	09.09-	RHH		EPBMWN4-A024H	90997		

EXPERT (222, 223, 224_)

1.9 D	1868	51	4	06.98-09.01	WJY, WJZ		EPBMWT5-A003H	93842		
1.9 D 70	1868	51	4	03.02-12.06	WJY		EPBMWT5-A003H	93842		
2.0 HDi	1997	69	4	07.00-12.06	RHX		EPBMWT5-A005H	93383		
2.0 HDi	1997	69	4	10.00-10.06	RHX		EPBMWT5-A003H	93842		
2.0 HDi 16V	1997	80	4	07.00-12.06	RHW		EPBMWT5-A003H	93842		



MAF



l kW
C
Y
I



Type-N°

Stock-N°

Plug In
Alternative
Type-N°

Plug In
Subtype

PEUGEOT

EXPERT (222, 223, 224_)

2.0 HDi	1997	80	4	02.02-12.06	RHW, RHZ		EPBMWT5-A003H	93842		
---------	------	----	---	-------------	----------	--	---------------	-------	--	--

EXPERT (VF3A_, VF3U_, VF3X_)

1.6 HDi 90 16V	1560	66	4	01.07-	9HU		EPBMFT5-A001H	93740		
1.6 HDi 90 8V	1560	66	4	01.07-	9HH, 9HM		EPBMWT4-A026H	95537		
2.0 HDi 100	1997	72	4	03.11-03.16	AHY		EPBMWN4-A024H	90997		
2.0 HDi 120	1997	88	4	01.07-	RHK		EPBMWT4-A008H	90627		
2.0 HDi 120 4x4	1997	88	4	01.07-	RHK		EPBMWT4-A008H	90627		
2.0 HDi 130	1997	94	4	03.11-	AHZ		EPBMWN4-A024H	90997		
2.0 HDi 130 4x4	1997	94	4	01.12-	AHZ		EPBMWN4-A024H	90997		
2.0 HDi 140	1997	100	4	01.07-	RHR		EPBMWT4-A008H	90627		
2.0 HDi 165	1997	120	4	09.09-	RHH		EPBMWN4-A024H	90997		

EXPERT KASTEN (V_)

2.0 BlueHDi 150	1997	110	4	04.16-	AHX		EPBMWT4-A028H	91236		
2.0 BlueHDi 180	1997	130	4	04.16-	AHH		EPBMWT4-A028H	91236		

PARTNER

1.6 HDi 75	1560	55	4	08.05-07.08	9HK		EPBMWT4-A026H	95537		
1.6 HDi	1560	55	4	04.08-	9HT, 9HW		EPBMFT5-A001H	93740		
1.6 HDi / BlueHDi 75	1560	55	4	06.08-	9HK, 9HN		EPBMWT4-A026H	95537		
1.6 HDi 16V	1560	66	4	01.09-	9HS, 9HX, 9HV		EPBMFT5-A001H	93740		
1.6 HDi 16V 4x4	1560	66	4	04.12-	9HS, 9HX		EPBMFT5-A001H	93740		
1.6 HDi	1560	66	4	03.13-	9HF		EPBMWT4-A026H	95537		
1.6 HDi 90	1560	68	4	04.10-	9HJ, 9HP		EPBMWT4-A026H	95537		
1.6 HDi	1560	80	4	04.08-	9HZ		EPBMFT5-A001H	93740		
1.6 HDi	1560	82	4	08.10-	9HL		EPBMFT5-A001H	93740		
1.6 HDi	1560	82	4	08.10-	9HL		EPBMWT4-A026H	95537		
1.6 HDi	1560	84	4	03.13-	9HL		EPBMWT4-A026H	95537		

PARTNER (5_, G_)

1.6 HDi 75	1560	55	4	08.05-07.08	9HW		EPBMFT5-A001H	93740		
1.6 HDi 90	1560	66	4	08.05-12.15	9HX, DV6ATED4		EPBMFT5-A001H	93740		
1.9 D	1868	51	4	11.01-09.02	WJY		EPBMWT5-A004H	91200		
1.9 D	1868	51	4	09.02-07.08	WJY		EPBMWT5-A003H	93842		
1.9 D 4x4	1868	51	4	04.04-07.11	WJY		EPBMWT5-A003H	93842		
1.9 D	1905	51	4	06.96-12.02	DJY		EPBMWT5-A004H	91200		
2.0 HDi	1997	66	4	02.00-07.08	RHY		EPBMWT5-A003H	93842		
2.0 HDi 4x4	1997	66	4	04.04-08.05	RHY		EPBMWT5-A003H	93842		

RCZ

2.0 HDi	1997	120	4	03.10-12.15	RHH		EPBMWT4-A028H	91236		
---------	------	-----	---	-------------	-----	--	---------------	-------	--	--



MAF



ℓ kW
C
Y
I



Type-N°

Stock-N°

Plug In
Alternative
Type-N°

Plug In
Subtype

PEUGEOT

TRAVELLER (V_)

2.0 BlueHDi 150	1997	110	4	04.16-	AHX		EPBMWT4-A028H	91236		
2.0 BlueHDi 180	1997	130	4	04.16-	AHH		EPBMWT4-A028H	91236		

PORSCHE

911 (996)

3.4 Carrera	3387	221	6	10.97-01.01	M9602, M9601		EPBMFT5-V001P	93006		
3.4 Carrera 4	3387	221	6	10.97-01.01	M9602, M9601		EPBMFT5-V001P	93006		
3.6	3596	235	6	12.01-08.05	M9603		EPBMFT5-V001P	93006		
3.6 Carrera	3596	235	6	10.01-07.04	M9603		EPBMFT5-V001P	93006		
3.6 Carrera 4	3596	235	6	10.01-08.05	M9603		EPBMFT5-V001P	93006		
3.6 Carrera 4S	3596	254	6	02.03-07.04	M9603		EPBMFT5-V001P	93006		
3.6 Carrera S	3596	254	6	02.03-08.05	M9603		EPBMFT5-V001P	93006		
3.6 GT3	3600	265	6	03.99-08.05	M9676		EPBMFT5-D003P	96835		
3.6 GT3	3600	280	6	03.03-08.05	M9679		EPBMFT5-D003P	96835		

911 (997)

3.6 Carrera	3596	235	6	04.05-07.05	M9605		EPBMFT5-V001P	93006		
3.6 Carrera	3596	239	6	04.05-12.08	M9605		EPBMFT5-V001P	93006		
3.6 Carrera 4	3596	239	6	04.05-12.08	M9605		EPBMFT5-V001P	93006		
3.6 GT3	3600	305	6	03.06-12.09	M9776		EPBMFT5-V001P	93006		
3.6 Carrera	3614	254	6	06.08-12.11	MA102		EPBMFT5-V001P	93006		
3.6 Carrera 4	3614	254	6	06.08-12.12	MA102		EPBMFT5-V001P	93006		
3.8 GT3	3797	320	6	05.09-12.11	M9777		EPBMFT5-V001P	93006		
3.8 GT3 RS	3797	331	6	08.09-12.11	M9777R		EPBMFT5-V001P	93006		
3.8 Carrera 4S	3800	283	6	06.08-12.12	MA101		EPBMFT5-V001P	93006		
3.8 Carrera S	3800	283	6	06.08-12.11	MA101		EPBMFT5-V001P	93006		
3.8 Carrera 4 GTS	3800	300	6	06.09-12.12	MA101		EPBMFT5-V001P	93006		
3.8 Carrera GTS	3800	300	6	06.09-12.11	MA101		EPBMFT5-V001P	93006		
3.8 Turbo S	3800	390	6	02.10-12.12	MA170		EPBMFT5-V001P	93006		
3.8 Carrera 4S	3824	261	6	04.05-12.08	M9701		EPBMFT5-V001P	93006		
3.8 Carrera S	3824	261	6	04.05-12.08	M9701		EPBMFT5-V001P	93006		
3.8 Carrera 4S	3824	264	6	04.05-12.10	M9701		EPBMFT5-V001P	93006		
3.8 Carrera 4S	3824	280	6	08.05-12.08	M9701S		EPBMFT5-V001P	93006		
3.8 Carrera S	3824	280	6	08.05-12.08	M9701S		EPBMFT5-V001P	93006		

BOXSTER (986)

2.5	2480	150	6	09.96-08.99	M9620	; for vehicles with e-throttle	EPBMFT5-V001P	93006		
2.5	2480	150	6	09.96-08.99	M9620	; for vehicles without e-throttle	EPBMFT5-D003P	96835		
2.7	2687	155	6	06.99-12.02	M9622	; for vehicles with e-throttle	EPBMFT5-V001P	93006		



MAF



l kW
C
y
I



Type-N°

Stock-N°

Plug In
Alternative
Type-N°

Plug In
Subtype

PORSCHE

BOXSTER (986)

2.7	2687	155	6	06.99-12.02	M9622	; for vehicles without e-throttle	EPBMFT5-D003P	96835		
2.7	2687	162	6	08.99-07.02	M9622	; for vehicles with e-throttle	EPBMFT5-V001P	93006		
2.7	2687	162	6	08.99-07.02	M9622	; for vehicles without e-throttle	EPBMFT5-D003P	96835		
2.7	2687	168	6	07.02-12.04	M9623	; for vehicles with e-throttle	EPBMFT5-V001P	93006		
2.7	2687	168	6	07.02-12.04	M9623	; for vehicles without e-throttle	EPBMFT5-D003P	96835		
S 3.2	3179	185	6	08.99-07.02	M9621	; for vehicles with e-throttle	EPBMFT5-V001P	93006		
S 3.2	3179	185	6	08.99-07.02	M9621	; for vehicles without e-throttle	EPBMFT5-D003P	96835		
S 3.2	3179	191	6	07.02-12.04	M9624	; for vehicles with e-throttle	EPBMFT5-V001P	93006		
S 3.2	3179	191	6	07.02-12.04	M9624	; for vehicles without e-throttle	EPBMFT5-D003P	96835		
S 3.2	3179	196	6	01.04-12.04	M9624	; for vehicles with e-throttle	EPBMFT5-V001P	93006		
S 3.2	3179	196	6	01.04-12.04	M9624	; for vehicles without e-throttle	EPBMFT5-D003P	96835		

CARRERA GT (980)

5.7	5733	450	10	07.03-12.06	M8001		EPBMFT5-V001P	93006		
-----	------	-----	----	-------------	-------	--	---------------	-------	--	--

PUCH

G-MODELL (W463)

G 500	4966	218	8	12.97-11.00	M113962		EPBMFT5-D043H	90272		
G 500	4966	218	8	12.97-11.00	M113962	; Chass.<X127404	EPBMFT5-D047H	97067		
G 55 AMG	5439	260	8	04.99-03.01	M113982		EPBMFT5-D043H	90272		

RENAULT

AVANTIME (DE0_)

2.2 dCi	2188	110	4	05.02-05.03	G9T712		EPBMFT6-A044H	92490		
---------	------	-----	---	-------------	--------	--	---------------	-------	--	--

CLIO II (BB_, CB_, SB0/1/2_)

1.5 dCi	1461	50	4	04.04-	K9K714		EPBMWT6-V013H	92412		
1.5 dCi	1461	62	4	02.07-06.09	K9K718		EPBMWT6-V013H	92412		
1.9 DTi	1870	59	4	02.00-05.01	F9Q780, F9Q782		EPBMWT6-A001H	90144		

CLIO III (BR0/1,CR0/1,KR0/1)

1.5 dCi	1461	47	4	06.05-	K9K752	OE 8200358901	EPBMFT6-A049H	93243		
1.5 dCi	1461	48	4	05.05-	K9K752	OE 8200358901	EPBMFT6-A049H	93243		
1.5 dCi	1461	50	4	04.08-06.08	K9K714, K9K768	OE 8200358901	EPBMFT6-A049H	93243		
1.5 dCi	1461	55	4	08.10-	K9K770	OE 8200358901	EPBMFT6-A049H	93243		
1.5 dCi	1461	60	4	11.07-	K9K750	OE 8200358901	EPBMFT6-A049H	93243		
1.5 dCi	1461	63	4	07.08-	K9K766	OE 8200358901	EPBMFT6-A049H	93243		
1.5 dCi	1461	65	4	08.10-	K9K766, K9K770, K9K772	OE 8200358901	EPBMFT6-A049H	93243		



MAF



l kW
C
Y
I



Type-N°

Stock-N°

Plug In
Alternative
Type-N°

Plug In
Stock-N°

RENAULT

CLIO III (BR0/1,CR0/1,KR0/1)

1.5 dCi	1461	76	4	06.05-	K9K772	OE 8200358901	EPBMFT6-A049H	93243		
1.5 dCi	1461	78	4	05.09-	K9K764, K9K774	OE 8200358901	EPBMFT6-A049H	93243		

CLIO IV (BH_, KH_,)

1.5 dCi 75	1461	55	4	01.13-	772, K9K764	OE 8200358901	EPBMFT6-A049H	93243		
1.5 dCi 90	1461	66	4	01.13-	772, K9K764	OE 8200358901	EPBMFT6-A049H	93243		
1.5 dCi 110	1461	81	4	06.16-	772, K9K764	OE 8200358901	EPBMFT6-A049H	93243		

DUSTER (HS_)

1.5 dCi 4x4	1461	66	4	06.11-	K9K884		EPBMWT4-A019H	94808		
-------------	------	----	---	--------	--------	--	---------------	-------	--	--

ESPACE III (JEO_)

1.9 dTi	1870	72	4	02.99-10.02	F9Q722		EPBMWT6-A001H	90144		
2.2 dCi	2188	85	4	10.00-10.02	G9T710		EPBMFT6-A044H	92490		
2.2 dCi	2188	95	4	10.00-10.02	G9T710, G9T642		EPBMFT6-A044H	92490		

ESPACE IV (JK0/1_)

1.9 dCi	1870	85	4	04.03-02.05	F9Q820		EPBMFT6-A044H	92490		
1.9 dCi	1870	88	4	11.02-	F9Q680, F9Q820, F9Q826		EPBMFT6-A044H	92490		
2.0 dCi	1995	96	4	01.06-	M9R740, M9R750, M9R760, M9R761, M9R762, M9R763		EPBMFT6-V046H	95763		
2.0 dCi	1995	110	4	01.06-	M9R740		EPBMFT6-V046H	95763		
2.0 dCi	1995	127	4	01.06-	M9R760		EPBMFT6-V046H	95763		
2.2 dCi	2188	102	4	02.06-	G9T645		EPBMFT6-A044H	92490		
2.2 dCi	2188	110	4	11.02-	G9T742, G9T743		EPBMFT6-A044H	92490		
3.0 dCi	2958	120	6	09.05-	P9X701, P9X715		EPBMFT5-V001P	93006		
3.0 dCi	2958	130	6	11.02-	P9X701		EPBMFT5-V001P	93006		
3.0 dCi	2958	133	6	01.06-	P9X715		EPBMFT5-V001P	93006		

FLUENCE (L3_)

1.5 dCi	1461	63	4	02.10-	K9K830		EPBMWT4-A022H	93854		
1.5 dCi	1461	78	4	02.10-	K9K832		EPBMWT4-A022H	93854		
1.5 dCi	1461	81	4	02.10-	K9K656, K9K657, K9K836, K9K837		EPBMWT4-A022H	93854		

GRAND SCÉNIC II (JM0/1_)

1.5 dCi	1461	74	4	04.04-11.08	K9K728		EPBMWT6-A007H	93605		
1.5 dCi	1461	78	4	05.05-01.09	K9K732		EPBMWT6-A001H	90144		
1.9 dCi	1870	81	4	-10.08	F9QE804		EPBMWT6-A001H	90144		
1.9 dCi	1870	85	4	05.05-01.09	F9Q803, F9Q804, F9Q812		EPBMWT6-A001H	90144		
1.9 dCi	1870	88	4	-05.05	F9Q812		EPBMWT6-A001H	90144		
1.9 dCi	1870	96	4	03.04-02.08	F9Q816, F9Q818, F9QEE804, F9QJ803		EPBMWT6-A001H	90144		
2.0 dCi	1995	110	4	09.05-11.08	M9R700		EPBMFT6-V046H	95763		

GRAND SCÉNIC III (JZ0/1_)

1.5 dCi	1461	63	4	04.09-	K9K830		EPBMWT4-A022H	93854		
1.5 dCi	1461	78	4	02.09-	K9K832		EPBMWT4-A022H	93854		



MAF



l kW
C
Y
I



Type-Nº

Stock-Nº

Plug In
Alternative
Type-Nº

Plug In
Subtype

RENAULT

GRAND SCÉNIC III (JZ0/1_)

1.5 dCi	1461	81	4	04.09-	K9K636, K9K836, K9K837		EPBMWT4-A022H	93854		
---------	------	----	---	--------	------------------------	--	---------------	-------	--	--

KANGOO (FC0/1_, KC0/1_)

1.5 dCi	1461	50	4	06.05-	K9K714		EPBMWT6-V013H	92412		
1.5 dCi	1461	60	4	04.03-	K9K702, K9K710		EPBMWT6-V013H	92412		
1.5 dCi	1461	62	4	06.05-	K9K718		EPBMWT6-V013H	92412		
1.9 dTi	1870	59	4	02.00-	F9Q780		EPBMWT6-A001H	90144		
1.9 dCi 4x4	1870	59	4	10.01-	F9Q782, F9Q790		EPBMWT6-A001H	90144		
1.9 dCi	1870	62	4	07.03-	F9Q782, F9Q790		EPBMWT6-A001H	90144		
1.9 dCi 4x4	1870	62	4	07.03-	F9Q790		EPBMWT6-A001H	90144		

KANGOO / GRAND KANGOO (FW0/1_, KW0/1_)

1.5 dCi	1461	50	4	02.08-	K9K800, K9K802		EPBMWT6-A007H	93605		
1.5 dCi	1461	50	4	02.08-	K9K800		EPBMWT6-A007H	93605		
1.5 dCi 75	1461	55	4	09.10-	K9K802		EPBMWT4-A019H	94808		
1.5 dCi 75	1461	55	4	09.10-	K9K608	; Type:FW07	EPBMWT4-A019H	94808		
1.5 dCi	1461	55	4	11.12-	K9K608, K9K628		EPBMWT6-A007H	93605		
1.5 dCi	1461	55	4	11.12-	K9K608, K9K628		EPBMWT4-A019H	94808		
1.5 dCi	1461	63	4	02.08-	K9K812		EPBMWT6-A007H	93605		
1.5 dCi 85	1461	63	4	02.08-	K9K812		EPBMWT6-A007H	93605		
1.5 dCi	1461	66	4	06.08-	K9K808, K9K608, K9K628		EPBMWT4-A019H	94808		
1.5 dCi 90	1461	66	4	06.09-	K9K608, K9K628, K9K808		EPBMWT6-A007H	93605		
1.5 dCi 90	1461	66	4	06.09-	K9K808, K9K608, K9K628		EPBMWT4-A019H	94808		
1.5 dCi	1461	67	4	08.17-	K9K647		EPBMWT4-A019H	94808		
1.5 dCi 90	1461	67	4	08.17-	K9K647		EPBMWT4-A019H	94808		
1.5 dCi	1461	76	4	02.08-	K9K806		EPBMWT6-A007H	93605		
1.5 dCi 110	1461	80	4	09.10-	K9K804, K9K816		EPBMWT6-A007H	93605		
1.5 dCi 110	1461	80	4	09.10-	K9K816	; Type:KW0H, FW0H	EPBMWT4-A019H	94808		
1.5 dCi 110	1461	81	4	03.13-	K9K636, K9K646, K9K647, K9K648		EPBMWT4-A019H	94808		

KOLEOS I (HY_)

2.0 dCi	1995	110	4	09.08-	M9R855, M9R856, M9R862, M9R865, M9R866		EPBMFN5-V005D	90496		
2.0 dCi 4x4	1995	110	4	09.08-	M9R832, M9R833, M9R834, M9R835, M9R836, M9R838, M9R850, M9R855, M9R856, M9R862, M9R865, M9R866		EPBMFN5-V005D	90496		
2.0 dCi 4x4	1995	127	4	09.08-	M9R830		EPBMFN5-V005D	90496		
2.5	2488	126	4	09.08-	2TR700, 2TR702, 2TR703		EPBMFN5-V005D	90496		
2.5 4x4	2488	126	4	09.08-	2TR700, 2TR702, 2TR703		EPBMFN5-V005D	90496		

LAGUNA COUPE (DT0/1)

2.0 dCi	1995	110	4	10.09-12.15	M9R802, M9R805		EPBMFT6-V046H	95763		
---------	------	-----	---	-------------	----------------	--	---------------	-------	--	--



MAF

 kW
C
Y
I

Type-N°

Stock-N°

 Plug In
Alternative
Type-N°

 Plug In
Stock-N°

RENAULT
LAGUNA COUPE (DT0/1)

2.0 dCi	1995	127	4	09.08-12.15	M9R800		EPBMFT6-V046H	95763		
2.0 dCi GT	1995	131	4	09.08-12.15	M9R816		EPBMFT6-V046H	95763		

LAGUNA I (B56_, 556_, K56_)

1.9 dTi	1870	72	4	09.99-	F9Q710, F9Q716		EPBMWT6-A001H	90144		
1.9 dCi	1870	79	4	09.99-03.01	F9Q718		EPBMWT6-A001H	90144		

LAGUNA II (BG0/1_,KG0/1_)

1.9 dCi	1870	68	4	03.04-05.05	F9Q664		EPBMFT6-A044H	92490		
1.9 dCi	1870	74	4	10.01-05.05	F9Q754, F9Q752		EPBMFT6-A044H	92490		
1.9 dCi	1870	77	4	06.01-05.05	F9Q752		EPBMFT6-A044H	92490		
1.9 dCi	1870	81	4	01.05-08.07	F9Q674, F9Q758		EPBMFT6-A044H	92490		
1.9 dCi	1870	85	4	08.05-09.07	F9Q758, F9Q759		EPBMFT6-A044H	92490		
1.9 dCi	1870	88	4	09.04-09.07	F9Q650, F9Q670, F9Q674, F9Q750		EPBMFT6-A044H	92490		
1.9 dCi	1870	96	4	05.05-08.07	F9Q758		EPBMFT6-A044H	92490		
2.0 dCi	1995	110	4	08.05-08.06	M9R740		EPBMFT6-V046H	95763		
2.0 dCi	1995	127	4	01.06-08.07	M9R760		EPBMFT6-V046H	95763		
2.2 dCi	2188	85	4	04.04-10.05	G9T600		EPBMFT6-A044H	92490		
2.2 dCi	2188	102	4	05.05-08.07	G9T600, G9T706, G9T707		EPBMFT6-A044H	92490		
2.2 dCi	2188	110	4	03.02-03.06	G9T700, G9T702		EPBMFT6-A044H	92490		

LAGUNA III (BT0/1,KT0/1)

1.5 dCi	1461	81	4	10.07-12.15	K9K780, K9K782, K9K846	, OE 8200358901	EPBMFT6-A049H	93243		
2.0 dCi	1995	96	4	10.07-12.15	M9R742		EPBMFT6-V046H	95763		
2.0 dCi	1995	110	4	10.07-12.15	M9R802		EPBMFT6-V046H	95763		
2.0 dCi	1995	127	4	01.08-12.15	M9R800		EPBMFT6-V046H	95763		
2.0 dCi GT	1995	131	4	03.08-12.15	M9R816, M9R820, M9R828		EPBMFT6-V046H	95763		

LATITUDE (L70_)

2.0 dCi 150	1995	110	4	02.11-	M9R824		EPBMFT6-V046H	95763		
2.0 dCi 175	1995	127	4	05.11-	M9R804		EPBMFT6-V046H	95763		

LOGAN I (KS_, LS_, US_)

1.5 dCi	1461	50	4	04.07-	K9K792		EPBMWT6-V013H	92412		
1.5 dCi	1461	63	4	02.08-06.15	K9K796		EPBMWT6-V013H	92412		

MASTER II (JD/ED/FD/HD/UD)

1.9 dTi	1870	59	4	09.00-	F9Q770		EPBMWT6-A001H	90144		
1.9 dCi 80	1870	60	4	11.01-	F9Q772, F9Q774		EPBMWT6-A001H	90144		
1.9 dCi 80	1870	60	4	11.01-	F9Q772, F9Q774		EPBMFT6-A044H	92490		
2.2 dCi 90	2188	66	4	09.00-	G9T720, G9T722, G9T750		EPBMFT6-A044H	92490		
2.5 dCi 100	2463	73	4	10.03-	G9U754		EPBMWT6-A007H	93605		
2.5 dCi 120	2463	84	4	10.01-11.03	G9U720		EPBMFT6-A044H	92490		
2.5 dCi 120	2463	84	4	01.04-	G9U754		EPBMWT6-A007H	93605		



MAF



l kW
C
y
I



Type-Nº

Stock-Nº

Plug In
Alternative
Type-Nº

Plug In
Subtype

RENAULT

MASTER II (JD/ED/FD/HD/UD)

2.5 dCi	2464	74	4	08.06-	G9U650		EPBMWT6-A007H	93605		
2.5 dCi	2464	88	4	08.06-	G9U650		EPBMWT6-A007H	93605		
2.5 dCi	2464	107	4	08.06-	G9U632		EPBMWT6-A007H	93605		

MEGANE CC (EZO/1_)

1.5 dCi	1461	81	4	06.10-	K9K837		EPBMWT4-A022H	93854		
---------	------	----	---	--------	--------	--	---------------	-------	--	--

MEGANE I (BAO/1_, LAO/1_, DAO/1_, KAO/1_)

1.9 dTi	1870	59	4	02.01-08.03	F9Q744		EPBMWT6-A001H	90144		
1.9 dT	1870	66	4	01.96-08.03	F8Q784, F8Q786		EPBMWT6-A001H	90144		
1.9 dTi	1870	72	4	03.97-02.01	F9Q731, F9Q734, F9Q736	OE 7700109812	EPBMWT6-A001H	90144		
1.9 dCi	1870	75	4	02.01-08.03	F9Q732, F9Q733, F9Q738	OE 7700109812	EPBMWT6-A001H	90144		
1.9 DCi	1870	77	4	03.99-08.03	F9Q732, F9Q738	OE 7700109812	EPBMWT6-A001H	90144		
1.9 dCi	1870	77	4	03.99-07.03	F9Q732, F9Q733		EPBMWT6-A001H	90144		

MEGANE II (BMO/1_, CMO/1_, EMO/1_, KMO/1_, KMO/2_, KM_, LMO/1_)

1.5 dCi	1461	60	4	-04.05	K9K722		EPBMWT6-A001H	90144		
1.5 dCi	1461	63	4	05.05-02.08	K9K724		EPBMWT6-A007H	93605		
1.5 dCi	1461	74	4	10.03-02.08	K9K729, K9K728		EPBMWT6-A001H	90144		
1.5 dCi	1461	76	4	01.07-03.09	K9K734		EPBMWT6-A001H	90144		
1.5 dCi	1461	76	4	01.07-06.09	K9K734		EPBMWT6-A007H	93605		
1.5 dCi	1461	78	4	05.05-05.06	K9K732		EPBMWT6-A007H	93605		
1.9 dCi	1870	81	4	05.05-02.08	F9Q804, F9Q816, F9Q818		EPBMWT6-A001H	90144		
1.9 dCi	1870	81	4	05.05-	F9Q803, F9Q804, F9Q816, F9Q818		EPBMWT6-A001H	90144		
1.9 dCi	1870	85	4	05.05-07.09	F9Q804, F9Q816, F9Q818		EPBMWT6-A001H	90144		
1.9 dCi	1870	88	4	08.03-07.09	F9Q800		EPBMWT6-A001H	90144		
1.9 dCi	1870	96	4	05.05-	F9Q803, F9Q804, F9Q816, F9Q818		EPBMWT6-A001H	90144		
2.0 dCi	1995	110	4	09.05-	M9R722, M9R700		EPBMFT6-V046H	95763		
2.0 dCi	1995	110	4	09.05-02.08	M9R700		EPBMFT6-V046H	95763		
2.0 dCi	1995	127	4	01.07-02.08	M9R724		EPBMFT6-V046H	95763		

MEGANE III (BZO/1_, B3_, DZO/1_, KZO/1_, BZ_)

1.5 dCi	1461	63	4	11.08-	K9K830		EPBMWT4-A022H	93854		
1.5 dCi	1461	81	4	02.09-	K9K636, K9K836, K9K837, K9K846		EPBMWT4-A022H	93854		

MEGANE SCENIC (JAO/1_)

1.9 dTi	1870	72	4	04.97-09.99	F9Q730, F9Q734		EPBMWT6-A001H	90144		
---------	------	----	---	-------------	----------------	--	---------------	-------	--	--

MODUS / GRAND MODUS (F/JPO_)

1.5 dCi	1461	50	4	12.04-	K9K768	OE 8200358901	EPBMFT6-A049H	93243		
1.5 dCi	1461	63	4	12.04-	K9K760, K9K766	OE 8200358901	EPBMFT6-A049H	93243		
1.5 dCi	1461	76	4	05.07-	K9K772	OE 8200358901	EPBMFT6-A049H	93243		
1.5 dCi	1461	78	4	05.05-	K9K764	OE 8200358901	EPBMFT6-A049H	93243		

SCÉNIC I (JAO/1_, FAO_)

1.9 dTi	1870	59	4	02.01-08.03	F9Q744		EPBMWT6-A001H	90144		
---------	------	----	---	-------------	--------	--	---------------	-------	--	--



MAF



l kW
C
Y
I



Type-N°

Stock-N°

Plug In
Alternative
Type-N°

Plug In
Stock-N°

RENAULT

SCÉNIC I (JA0/1_, FA0_)

1.9 dTi	1870	72	4	09.99-08.03	F9Q736		EPBMWT6-A001H	90144		
1.9 dCi RX4	1870	74	4	12.02-08.03	F9Q732, F9Q748, F9Q796		EPBMWT6-A001H	90144		
1.9 dCi	1870	75	4	09.99-08.03	F9Q732		EPBMWT6-A001H	90144		
1.9 dCi RX4	1870	75	4	11.00-08.03	F9Q740		EPBMWT6-A001H	90144		

SCÉNIC II (JM0/1_)

1.5 dCi	1461	63	4	05.05-11.08	K9K724		EPBMWT6-A007H	93605		
1.5 dCi	1461	74	4	11.03-08.05	K9K728, K9K729		EPBMWT6-A001H	90144		
1.5 dCi	1461	76	4	01.07-11.08	K9K728, K9K734		EPBMWT6-A007H	93605		
1.5 dCi	1461	78	4	05.05-11.08	K9K732, K9K734		EPBMWT6-A007H	93605		
1.9 dCi	1870	81	4	05.05-11.08	F9Q804		EPBMWT6-A001H	90144		
1.9 D	1870	85	4	06.06-11.08	F9QJ803, F9Q812		EPBMWT6-A001H	90144		
1.9 dCi	1870	88	4	06.03-05.06	F9Q812		EPBMWT6-A001H	90144		
1.9 dCi	1870	92	4	06.03-11.08	F9Q804		EPBMWT6-A001H	90144		
1.9 dCi	1870	96	4	05.05-11.08	F9Q804, F9Q816, F9Q818, F9QJ803		EPBMWT6-A001H	90144		
2.0 dCi	1995	110	4	09.05-11.08	M9R700		EPBMFT6-V046H	95763		

SCÉNIC III (JZ0/1_)

1.5 dCi	1461	63	4	04.09-	K9K830		EPBMWT4-A022H	93854		
1.5 dCi	1461	78	4	02.09-	K9K832		EPBMWT4-A022H	93854		
1.5 dCi	1461	81	4	04.09-	K9K636, K9K656, K9K657, K9K836, K9K837		EPBMWT4-A022H	93854		

THALIA I (LB_) | CLIO SYMBOL

1.5 dCi	1461	50	4	02.03-	K9K714		EPBMWT6-V013H	92412		
1.5 dCi	1461	62	4	06.01-02.09	K9K718		EPBMWT6-V013H	92412		

THALIA II (LU_) | SYMBOL

1.5 dCi	1461	62	4	09.08-	K9K718		EPBMWT6-V013H	92412		
---------	------	----	---	--------	--------	--	---------------	-------	--	--

TRAFIC II (EL,FL,JL)

1.9 dCi	1870	59	4	04.01-07.03	F9Q762		EPBMWT6-A001H	90144		
1.9 dCi 80	1870	60	4	03.01-	F9Q762		EPBMWT6-A001H	90144		
1.9 dCi 100	1870	74	4	03.01-	F9Q760		EPBMWT6-A001H	90144		
2.0 dCi 90	1995	66	4	08.06-	M9R630, M9R692		EPBMWT4-A019H	94808		
2.0 dCi 90	1995	66	4	08.06-	M9R630, M9R780, M9R782		EPBMWT6-A007H	93605		
2.0 dCi 115	1995	84	4	08.06-	M9R780, M9R782, M9R786, M9R692	; Type:EL00, EL01	EPBMWT4-A019H	94808		
2.0 dCi 115	1995	84	4	08.06-	M9R786, M9R782, M9R780		EPBMWT6-A007H	93605		
2.5 dCi	2463	84	4	08.07-	G9U630		EPBMWT6-A007H	93605		
2.5 dCi 135	2463	99	4	03.01-	G9U730		EPBMWT6-A001H	90144		
2.5 dCi 115	2464	84	4	02.08-	G9U630		EPBMWT6-A007H	93605		
2.5 dCi 135	2464	99	4	05.03-	G9U730		EPBMWT6-A001H	90144		
2.5 dCi 145	2464	107	4	08.06-	G9U630		EPBMWT6-A007H	93605		



MAF



l kW
C
Y
I



Type-Nº

Stock-Nº

Plug In
Alternative
Type-Nº

Plug In
Subtype

RENAULT

TWINGO II (CNO_)

1.5 dCi 75	1461	55	4	10.10-	K9K820		EPBMWT4-A022H	93854		
1.5 dCi	1461	62	4	04.08-	K9K718		EPBMWT6-V013H	92412		
1.5 dCi 90	1461	63	4	10.10-	K9K820		EPBMWT4-A022H	93854		

VEL SATIS (BJO_)

2.0 dCi	1995	110	4	08.05-	M9R760		EPBMFT6-V046H	95763		
2.0 dCi	1995	127	4	01.06-	M9R760		EPBMFT6-V046H	95763		
2.2 dCi	2188	85	4	04.04-	G9T600, G9T702		EPBMFT6-A044H	92490		
2.2 dCi	2188	102	4	09.04-	G9T600, G9T606, G9T607, G9T700, G9T702		EPBMFT6-A044H	92490		
2.2 dCi	2188	110	4	06.02-	G9T702, G9T703		EPBMFT6-A044H	92490		
3.0 dCi	2958	130	6	06.02-	P9X701		EPBMFT5-V001P	93006		
3.0 dCi	2958	133	6	06.06-	P9X715		EPBMFT5-V001P	93006		

ROVER

200 HATCHBACK (RF)

220 D/SD	1994	63	4	11.95-03.00	20T2R	; Chass.>YD471565	EPBMFT5-V031H	97525		
220 SDi	1994	77	4	11.95-03.00	20T2N	; Chass.>YD471565	EPBMFT5-V031H	97525		

25 HATCHBACK (RF)

2.0 iDT	1994	74	4	10.99-05.05	20T2N		EPBMFT5-V031H	97525		
---------	------	----	---	-------------	-------	--	---------------	-------	--	--

400 (RT)

420 D	1994	63	4	11.95-03.00	20T2R	; Chass.>YD471064	EPBMFT5-V031H	97525		
420 Di	1994	77	4	05.95-03.00	20T2N	; Chass.>YD471064	EPBMFT5-V031H	97525		

45 (RT)

2.0 iDT	1994	74	4	02.00-05.05	20T2N	; Chass.>YD471064	EPBMFT5-V031H	97525		
2.0 iDT	1994	83	4	01.04-05.05	20T2N	; Chass.>YD471064	EPBMFT5-V031H	97525		

75 / 75 TOURER (RJ)

2.0 CDT	1951	85	4	02.99-05.05	204D2, M47D20, M47R		EPBMFT5-D015H	92304	EPBMFT5-D003P	96835
2.0 CDTi	1951	96	4	02.03-05.05	204D2		EPBMFT5-D015H	92304	EPBMFT5-D003P	96835

STREETWISE HATCHBACK

2.0 TD	1994	74	4	08.03-05.05	20T2N	; Chass.>YD471064	EPBMFT5-V031H	97525		
--------	------	----	---	-------------	-------	-------------------	---------------	-------	--	--

SAAB

900 II

2.0 i	1985	96	4	08.94-12.95	B204I		EPBMFN4-A035H	97899		
2.0 i	1985	98	4	07.93-07.94	B206I		EPBMFN4-A035H	97899		
2.3-16	2290	110	4	07.93-12.95	B234I		EPBMFN4-A035H	97899		

9-3 (YS3D)

2.2 TiD	2171	85	4	02.98-11.00	D223L, X22DTH	; Chass.<12020000	EPBMFT5-V037H	95360	EPBMFT5-V001P	93006
2.2 TiD	2171	92	4	11.00-09.02	D223L	; Chass.<12020000	EPBMFT5-V037H	95360	EPBMFT5-V001P	93006

9-3 (YS3F, D79, D75, E50, E79)

1.8 i	1796	90	4	01.04-02.15	Z18XE		EPBMWT4-V002H	92668		
1.9 TiD	1910	88	4	09.04-02.15	Z19DT		EPBMFN4-V026H	94497		
1.9 TiD	1910	88	4	09.04-02.15	Z19DT		EPBMFN4-V010H	97588		



MAF



l kW
C
Y
I



Type-Nº

Stock-Nº

Plug In
Alternative
Type-Nº

Plug In
Stock-Nº

SAAB

9-3 (YS3F, D79, D75, E50, E79)

1.9 TTiD	1910	96	4	12.07-02.15	A19DTR		EPBMFN4-V020H	90971		
1.9 TiD	1910	110	4	09.04-02.15	Z19DTH		EPBMFN4-V026H	94497		
1.9 TiD	1910	110	4	09.04-09.10	Z19DTH		EPBMFN4-V010H	97588		
1.9 TTiD	1910	118	4	12.07-02.15	A19DTR		EPBMFN4-V020H	90971		
1.9 TTiD	1910	132	4	12.07-02.15	Z19DTR		EPBMFN4-V020H	90971		
2.2 TiD	2171	92	4	09.02-06.04	D223L		EPBMFT5-V019H	96039	EPBMFT5-V001P	93006

9-3X (YS3)

1.9 TTiD AWD	1910	132	4	02.09-12.12	Z19DTR		EPBMFN4-V020H	90971		
--------------	------	-----	---	-------------	--------	--	---------------	-------	--	--

9-5 (YS3E)

1.9 TiD	1910	110	4	01.06-12.09	Z19DTH		EPBMFN4-V026H	94497		
1.9 TiD	1910	110	4	01.06-12.09	Z19DTH		EPBMFN4-V010H	97588		
1.9 TiD	1910	129	4	01.07-12.09	Z19DTR		EPBMFN4-V010H	97588		

9-5 (YS3G)

1.6 Turbo	1598	132	4	05.10-01.12	A16LET		EPBMFT5-T003H	91493		
2.0 TiD	1956	118	4	05.10-01.12	A20DTH		EPBMFT5-T003H	91493		
2.0 TTiD	1956	140	4	05.10-01.12	A20DTR		EPBMFT5-T003H	91493		
2.0 TTiD XWD	1956	140	4	05.10-01.12	A20DTR		EPBMFT5-T003H	91493		

SEAT

ALHAMBRA (710, 711)

1.8 TSI	1798	118	4	11.12-	CDA A		EPBMWT5-A027H	96756		
2.0 TDI	1968	85	4	05.11-	CFFE, CUVA		EPBMFN4-V008H	95035		
2.0 TDI	1968	100	4	06.10-05.11	CFFA		EPBMFN4-V008H	95035		
2.0 TDI	1968	103	4	06.10-	CFFB		EPBMFN4-V008H	95035		
2.0 TDI 4Drive	1968	103	4	05.11-	CFFB		EPBMFN4-V008H	95035		
2.0 TDI	1968	110	4	05.15-	CUVC, DFLA, DLTA		EPBMFN4-V008H	95035		
2.0 TDI 4Drive	1968	110	4	05.15-	CUVC, DFLA		EPBMFN4-V008H	95035		
2.0 TDI	1968	125	4	06.10-	CFGB		EPBMFN4-V008H	95035		
2.0 TDI	1968	130	4	11.12-	CFGC, DLUB		EPBMFN4-V008H	95035		
2.0 TDi 4Drive	1968	130	4	11.18-	DLUB		EPBMFN4-V008H	95035		
2.0 TDI	1968	135	4	05.15-	CUWA, DFMA		EPBMFN4-V008H	95035		
2.0 TDI 4Drive	1968	135	4	05.16-	DFMA		EPBMFN4-V008H	95035		
2.0 TSI	1984	147	4	11.10-	CCZA		EPBMWT5-A027H	96756		

ALHAMBRA (7V8, 7V9)

1.8 T 20V	1781	110	4	10.97-03.10	AWC		EPBMFT5-D005P	90557		
1.9 TDI	1896	66	4	04.96-01.98	AHU, 1Z	Chass.<7MW507041	EPBMWN6-D029H	90628		
1.9 TDI	1896	66	4	04.96-01.98	AHU	Chass.>7MW507042	EPBMFN5-D005H	92204	EPBMFN5-D002P	91609
1.9 TDI	1896	66	4	05.02-05.05	ANU		EPBMFN5-D005H	92204	EPBMFN5-D002P	91609
1.9 TDI	1896	81	4	08.96-06.00	AFN	Chass.<7MW507041	EPBMWN6-D029H	90628		
1.9 TDI	1896	81	4	08.96-06.00	AFN	Chass.>7MW507042	EPBMFN5-D005H	92204	EPBMFN5-D002P	91609
1.9 TDI	1896	81	4	01.98-06.00	AVG		EPBMFN5-D005H	92204	EPBMFN5-D002P	91609
1.9 TDI	1896	85	4	06.00-03.10	AUY, BVK		EPBMFN5-D005H	92204	EPBMFN5-D002P	91609
1.9 TDI 4motion	1896	85	4	06.00-03.10	AUY		EPBMFN5-D003H	95299	EPBMFN5-D002P	91609
1.9 TDI	1896	96	4	11.02-11.08	ASZ		EPBMFN5-D002H	91692	EPBMFN5-D002P	91609



MAF



l kW
C
Y
I



Type-N°

Stock-N°

Plug In
Alternative
Type-N°

Plug In
Subtype

SEAT

ALHAMBRA (7V8, 7V9)

1.9 TDI	1896	110	4	05.05-05.07	BTB		EPBMFN5-D002H	91692	EPBMFN5-D002P	91609
2.0 TDI	1968	103	4	11.05-03.10	BRT		EPBMFN5-D002H	91692	EPBMFN5-D002P	91609
2.0 i	1984	85	4	06.00-03.10	ATM		EPBMFT5-D005P	90557		
2.8 V6	2792	150	6	06.00-03.10	AYL, AUE		EPBMFT5-D024H	93373		
2.8 V6	2792	150	6	08.00-06.06	AYL		EPBMFN5-D013H	96315		
2.8 V6 4motion	2792	150	6	06.00-03.10	AYL, AUE		EPBMFT5-D024H	93373		
2.8 V6 4motion	2792	150	6	08.00-06.06	AYL		EPBMFN5-D013H	96315		

ALTEA (5P1, 5P5, 5P8)

1.6 TDI	1598	66	4	11.10-	CAYB		EPBMWT3-D024H	91171		
1.8 TFSI	1798	118	4	01.07-	BZB, BYT		EPBMWN5-D027H	91976		
1.8 TFSI	1798	118	4	01.07-	CDAA		EPBMWT5-A027H	96756		
1.9 TDI	1896	66	4	08.09-	BXF		EPBMFN5-D003H	95299		
1.9 TDI	1896	77	4	04.04-05.10	BJB, BKC, BLS, BXE		EPBMFN5-D003H	95299	EPBMFN5-D002P	91609
1.9 TDI 4x4	1896	77	4	06.09-12.10	BLS		EPBMFN5-D003H	95299		
2.0 TDI	1968	100	4	03.04-03.09	AZV		EPBMFN5-D002H	91692	EPBMFN5-D002P	91609
2.0 TDI 16V	1968	103	4	03.04-07.11	BKD		EPBMFN5-D002H	91692	EPBMFN5-D002P	91609
2.0 TDI 16V	1968	103	4	03.04-	CFHC		EPBMFN4-V008H	95035		
2.0 TDI	1968	103	4	10.06-	BMM		EPBMFN5-D002H	91692	EPBMFN5-D002P	91609
2.0 TDI 16V 4x4	1968	103	4	10.10-	CFHC		EPBMFN4-V008H	95035		
2.0 TDI	1968	125	4	03.06-	BMN		EPBMFN5-D002H	91692	EPBMFN5-D002P	91609
2.0 TDI	1968	125	4	06.07-	CEGA		EPBMFN5-D001H	95207		
2.0 TDI 4x4	1968	125	4	06.07-06.09	BMN		EPBMFN5-D002H	91692	EPBMFN5-D002P	91609
2.0 TDI 4x4	1968	125	4	06.07-	CEGA		EPBMFN5-D001H	95207		
2.0 TDI 4x4	1968	125	4	06.07-	CFJA		EPBMFN4-V008H	95035		
2.0 TFSI	1984	147	4	04.06-05.09	BWA		EPBMWN5-D003D	94436		
2.0 TFSI 4x4	1984	147	4	06.07-05.09	BWA		EPBMWN5-D003D	94436		
2.0 TFSI 4x4	1984	155	4	05.09-	CCZB		EPBMWT5-A027H	96756		

AROSA (6H1)

1.4 TDI	1422	55	3	01.00-06.04	AMF		EPBMFN5-D022H	91168	EPBMFN5-D002P	91609
---------	------	----	---	-------------	-----	--	---------------	-------	---------------	-------

ATECA (KH7, KHP)

2.0 TDI	1968	81	4	10.16-	CRVA		EPBMFN4-V008H	95035		
2.0 TDI	1968	110	4	04.16-	DFFA		EPBMFN4-V008H	95035		
2.0 TDI 4Drive	1968	110	4	04.16-	DFFA		EPBMFN4-V008H	95035		
2.0 TDI 4Drive	1968	140	4	06.16-	DFHA		EPBMFN4-V008H	95035		

CORDOBA (6K1, 6K2, 6K5)

1.8 T 20V Cupra	1781	115	4	07.00-10.02	AQX, AYP		EPBMFN5-D012H	96277		
1.8 T 20V Cupra	1781	115	4	07.00-10.02	AQX, AYP	OE 06A906461D	EPBMFN5-D016H	96999		
1.9 TDI	1896	66	4	08.96-10.02	1Z, AGR, AHU, ALH		EPBMWN6-D029H	90628		
1.9 TDI	1896	81	4	03.97-10.02	AFN, ASK, ASV		EPBMWN6-D029H	90628		

CORDOBA (6L2)

1.4 TDI	1422	51	3	05.05-11.09	BNM		EPBMFN5-D003H	95299		
1.4 TDI	1422	55	3	10.02-12.05	AMF		EPBMFN5-D003H	95299		
1.4 TDI	1422	59	3	06.05-11.09	BMS, BNV		EPBMFN5-D003H	95299		
1.9 TDI	1896	74	4	09.02-11.09	ATD, AXR		EPBMFN5-D003H	95299	EPBMFN5-D002P	91609



MAF

 e kW
C
Y
I

Type-N°

Stock-N°

 Plug In
Alternative
Type-N°

 Plug In
Subtype

SEAT
CORDOBA (6L2)

1.9 TDI	1896	96	4	10.02-11.09	ASZ, BLT		EPBMFN5-D002H	91692	EPBMFN5-D002P	91609
2.0	1984	85	4	09.02-11.09	BBX		EPBMFT5-D005P	90557		

EXEO (3R2,3R5)

1.6	1595	75	4	03.09-09.10	ALZ		EPBMWT4-D014H	93236		
1.8 T	1781	110	4	06.09-05.10	CFMA		EPBMFN5-D012H	96277		
1.8 TSI	1798	88	4	09.10-05.13	CDHA		EPBMWT5-A027H	96756		
1.8 TSI	1798	118	4	05.10-05.13	CDHB		EPBMWT5-A027H	96756		
2.0 TDI	1968	88	4	07.09-05.13	CAGC		EPBMFN5-D001H	95207		
2.0 TDI	1968	88	4	07.09-05.13	CJCC		EPBMFN4-V008H	95035		
2.0 TDI	1968	105	4	05.09-05.13	CAGA		EPBMFN5-D001H	95207		
2.0 TDI	1968	105	4	05.09-05.13	CJCA		EPBMFN4-V008H	95035		
2.0 TDI	1968	125	4	02.09-05.13	CAHA		EPBMFN5-D001H	95207		
2.0 TDI	1968	125	4	02.09-05.13	CGLB		EPBMFN4-V008H	95035		
2.0 TFSI	1984	155	4	05.10-05.13	CDND		EPBMWT5-A027H	96756		

IBIZA II (6K1)

1.8 T 20V Cupra	1781	115	4	07.00-02.02	AQX, AYP		EPBMFN5-D002P	91609		
1.9 TDI	1896	66	4	08.96-02.02	1Z, AGR, AHU, ALH		EPBMWN6-D029H	90628		
1.9 TDI	1896	81	4	02.97-02.02	AFN, ASK, ASV		EPBMWN6-D029H	90628		

IBIZA III (6L1)

1.4 TDI	1422	51	3	05.05-11.09	BNM		EPBMFN5-D003H	95299		
1.4 TDI	1422	55	3	05.02-04.04	AMF		EPBMFN5-D003H	95299	EPBMFN5-D002P	91609
1.4 TDI	1422	59	3	06.05-11.09	BMS, BNV		EPBMFN5-D003H	95299		
1.8 T FR	1781	110	4	12.03-05.08	BJX, BKV		EPBMFN5-D012H	96277	EPBMFN5-D002P	91609
1.8 T Cupra R	1781	132	4	01.04-02.08	BBU		EPBMFN5-D012H	96277	EPBMFN5-D002P	91609
1.9 TDI	1896	74	4	02.02-04.04	ATD	Chass.<6L2050000	EPBMFN5-D005H	92204	EPBMFN5-D002P	91609
1.9 TDI	1896	74	4	02.02-04.04	BMT, AXR, ATD	Chass.>6L2050001	EPBMFN5-D003H	95299	EPBMFN5-D002P	91609
1.9 TDI	1896	96	4	02.02-11.09	ASZ, BLT		EPBMFN5-D002H	91692	EPBMFN5-D002P	91609
1.9 TDI Cupra R	1896	118	4	03.04-02.08	BPX, BUK		EPBMFN5-D002H	91692	EPBMFN5-D002P	91609
2.0	1984	85	4	04.02-11.09	AZL, BBX		EPBMFT5-D005P	90557		

IBIZA IV (6J5, 6P1, 6J1, 6P5, 6J8, 6P8)

1.4 TDI	1422	59	3	07.08-06.10	BMS		EPBMFN5-D003H	95299		
1.6 TDI	1598	66	4	03.10-	CAYB	Chass.>6J9000001	EPBMWT3-D024H	91171		
1.9 TDI	1896	66	4	07.08-06.10	BJX		EPBMFN5-D003H	95299		
1.9 TDI	1896	77	4	03.08-06.10	BLS		EPBMFN5-D003H	95299		
2.0 TDI	1968	105	4	01.10-	CFHD		EPBMFN4-V008H	95035		

LEON I (1M1)

1.6	1595	74	4	11.99-06.06	AKL, AEH		EPBMWT4-D014H	93236		
1.6	1595	75	4	10.05-06.06	BFQ, BGU		EPBMWT4-D014H	93236		
1.8 20V	1781	92	4	11.99-04.01	APG, AGN		EPBMFT5-D005P	90557		
1.8 20V T	1781	132	4	11.99-12.00	APP		EPBMFN5-D016H	96999	EPBMFN5-D002P	91609
1.8 20V T 4	1781	132	4	11.99-01.01	AJQ		EPBMFN5-D016H	96999	EPBMFN5-D002P	91609
1.8 20V T	1781	132	4	09.00-06.06	AUQ		EPBMFN5-D012H	96277	EPBMFN5-D002P	91609
1.8 20V T 4	1781	132	4	09.00-06.06	ARY		EPBMFN5-D012H	96277	EPBMFN5-D002P	91609
1.8 T Cupra R	1781	154	4	02.02-06.06	AMK		EPBMFN5-D021H	90140		



MAF

 kW
C
Y
I

Type-N°

Stock-N°

Plug In
Alternative
Type-N°Plug In
Subtype

SEAT

LEON I (1M1)

1.8 T Cupra R	1781	165	4	07.03-06.06	BAM		EPBMFN5-D021H	90140		
1.9 TDI	1896	66	4	11.99-06.06	AGR		EPBMFN5-D005H	92204	EPBMFN5-D002P	91609
1.9 TDI	1896	66	4	11.99-06.06	ALH		EPBMFN5-D003H	95299	EPBMFN5-D002P	91609
1.9 TDI	1896	66	4	11.99-06.06	ALH	SINGLE GAUZE	EPBMFN5-D005H	92204		
1.9 TDI	1896	74	4	10.05-06.06	AXR		EPBMFN5-D003H	95299		
1.9 TDI	1896	81	4	11.99-06.06	ASV		EPBMFN5-D002P	91609		
1.9 TDI	1896	81	4	11.99-06.06	ASV		EPBMFN5-D003H	95299		
1.9 TDI	1896	81	4	11.99-06.06	ASV	SINGLE GAUZE	EPBMFN5-D005H	92204		
1.9 TDI	1896	81	4	05.01-08.02	AHF		EPBMFN5-D005H	92204	EPBMFN5-D002P	91609
1.9 TDI	1896	96	4	05.03-06.06	ASZ		EPBMFN5-D002H	91692	EPBMFN5-D002P	91609
1.9 TDI	1896	110	4	09.00-06.06	ARL	Chass.<1M3011800	EPBMFN5-D013H	96315	EPBMFN5-D002P	91609
1.9 TDI	1896	110	4	09.00-06.06	ARL	Chass.>1M3011800	EPBMFN5-D002H	91692	EPBMFN5-D002P	91609
1.9 TDI Syncro	1896	110	4	05.02-06.06	ARL	Chass.<1M3011800	EPBMFN5-D013H	96315	EPBMFN5-D002P	91609
1.9 TDI Syncro	1896	110	4	05.02-06.06	ARL	Chass.>1M3011800	EPBMFN5-D002H	91692	EPBMFN5-D002P	91609
2.8 Cupra 4	2792	150	6	02.01-06.06	AUE		EPBMFT5-D024H	93373		
2.8 Cupra 4	2792	150	6	02.01-06.06	AUE		EPBMFN5-D013H	96315		
2.8	2792	150	6	05.02-06.04	BDE		EPBMFT5-D024H	93373		
2.8	2792	150	6	05.02-06.04	BDE		EPBMFN5-D013H	96315		

LEON II (1P1)

1.6 TDI	1598	66	4	11.10-12.12	CAYB		EPBMWT3-D024H	91171		
1.8 TSI	1798	118	4	06.07-12.12	BZB		EPBMWN5-D027H	91976		
1.8 TSI	1798	118	4	06.07-12.12	CDA A		EPBMWT5-A027H	96756		
1.9 TDI	1896	66	4	06.07-12.10	BXF		EPBMFN5-D003H	95299	EPBMFN5-D002P	91609
1.9 TDI	1896	77	4	07.05-12.10	BKC, BLS, BXE		EPBMFN5-D003H	95299	EPBMFN5-D002P	91609
2.0 TDI	1968	100	4	07.05-05.10	AZV		EPBMFN5-D002H	91692	EPBMFN5-D002P	91609
2.0 TDI	1968	103	4	10.05-10.10	BMM		EPBMFN5-D002H	91692	EPBMFN5-D002P	91609
2.0 TDI 16V	1968	103	4	07.05-12.12	BKD		EPBMFN5-D002H	91692	EPBMFN5-D002P	91609
2.0 TDI 16V	1968	103	4	07.05-12.12	CFHC, CLCB		EPBMFN4-V008H	95035	EPBMFN5-D002P	91609
2.0 TDI	1968	125	4	05.06-12.12	BMN		EPBMFN5-D002H	91692	EPBMFN5-D002P	91609
2.0 TDI	1968	125	4	05.06-12.12	CEGA		EPBMFN5-D001H	95207	EPBMFN5-D002P	91609
2.0 TDI	1968	125	4	05.06-12.12	CFJA		EPBMFN4-V008H	95035	EPBMFN5-D002P	91609
2.0 TFSI	1984	147	4	05.05-03.09	BWA		EPBMWN5-D003D	94436		
2.0 TFSI	1984	155	4	06.09-12.12	CCZB		EPBMWT5-A027H	96756		
2.0 TFSI	1984	177	4	11.06-05.11	BWJ, CDLD		EPBMWN5-D003D	94436		
2.0 Cupra R	1984	195	4	09.09-12.12	CDLA		EPBMWN5-D003D	94436		

LEON III (5F1, 5F5, 5F8)

2.0 TDI	1968	81	4	05.13-	CRVA		EPBMFN4-V008H	95035		
2.0 TDI	1968	105	4	05.13-	CRVC		EPBMFN4-V008H	95035		
2.0 TDI	1968	110	4	10.12-	CKFC, CRMB, CRLB, CRBC, DFFA, DFGA		EPBMFN4-V008H	95035		
2.0 TDI 4Drive	1968	110	4	04.14-	CRMB, CRLB, CRBC, DFGA, DCYA		EPBMFN4-V008H	95035		
2.0 TDI	1968	135	4	02.13-	CUPA, CUNA, DJGA		EPBMFN4-V008H	95035		
2.0 TDI 4Drive	1968	135	4	10.14-	CUNA, DJGA		EPBMFN4-V008H	95035		

TARRACO (KN2)

2.0 TDi	1968	110	4	09.18-	DFGA		EPBMFN4-V008H	95035		
---------	------	-----	---	--------	------	--	---------------	-------	--	--



MAF



l kW
C
Y
I



Type-N°

Stock-N°

Plug In
Alternative
Type-N°

Plug In
Subtype

SEAT

TARRACO (KN2)

2.0 TDi 4Drive	1968	110	4	09.18-	DFGA		EPBMFN4-V008H	95035		
2.0 TDi 4Drive	1968	140	4	09.18-	DFHA		EPBMFN4-V008H	95035		

TOLEDO I (1L2)

1.9 TDI	1896	66	4	08.95-03.99	1Z, AHU		EPBMWN6-D029H	90628		
1.9 TDI	1896	81	4	11.96-03.99	AFN		EPBMWN6-D029H	90628		

TOLEDO II (1M2)

1.6	1595	74	4	10.98-07.04	AKL, AEH		EPBMWT4-D014H	93236		
1.8 20V	1781	92	4	10.98-07.04	APG, AGN		EPBMFT5-D005P	90557		
1.8 20V T	1781	132	4	09.00-07.04	APP	Chass.<1M1R028000; Chass.<1M1B023000	EPBMFN5-D016H	96999	EPBMFN5-D002P	91609
1.8 20V T	1781	132	4	09.00-07.04	APP	Chass.>1M1R028001; Chass.>1M1B023001	EPBMFN5-D012H	96277	EPBMFN5-D002P	91609
1.8 20V T	1781	132	4	09.00-07.04	AUQ		EPBMFN5-D012H	96277	EPBMFN5-D002P	91609
1.9 TDI	1896	66	4	05.01-07.04	ALH		EPBMFN5-D005H	92204	EPBMFN5-D002P	91609
1.9 TDI	1896	81	4	05.01-07.04	AHF, ASV		EPBMFN5-D003H	95299	EPBMFN5-D002P	91609
1.9 TDI	1896	96	4	05.03-05.06	ASZ		EPBMFN5-D002H	91692	EPBMFN5-D002P	91609
1.9 TDI	1896	110	4	10.00-07.04	ARL	Chass.<1M3011800	EPBMFN5-D013H	96315	EPBMFN5-D002P	91609
1.9 TDI	1896	110	4	10.00-07.04	ARL	Chass.>1M3011801	EPBMFN5-D002H	91692	EPBMFN5-D002P	91609
2.3 V5	2324	110	5	10.98-11.00	AGZ		EPBMFN5-D013H	96315	EPBMFN5-D002P	91609
2.3 V5 20V	2324	125	5	09.00-11.03	AQN		EPBMFT5-D024H	93373		
2.3 V5 20V	2324	125	5	09.00-11.03	AQN		EPBMFN5-D013H	96315		

TOLEDO III (5P2)

1.8 TFSI	1798	118	4	01.07-05.09	BZB		EPBMWN5-D027H	91976		
1.8 TFSI	1798	118	4	01.07-05.09	CDAA		EPBMWT5-A027H	96756		
1.9 TDI	1896	77	4	10.04-05.09	BJB, BKC, BLS, BXE		EPBMFN5-D003H	95299	EPBMFN5-D002P	91609
2.0 TDI	1968	100	4	09.04-05.09	AZV		EPBMFN5-D002H	91692	EPBMFN5-D002P	91609
2.0 TDI 16V	1968	103	4	04.04-05.09	BKD		EPBMFN5-D002H	91692	EPBMFN5-D002P	91609
2.0 TDI	1968	103	4	11.05-05.09	BMM		EPBMFN5-D002H	91692	EPBMFN5-D002P	91609
2.0 TDI	1968	125	4	01.06-05.09	BMN		EPBMFN5-D002H	91692	EPBMFN5-D002P	91609
2.0 TDI	1968	125	4	01.06-05.09	CEGA		EPBMFN5-D001H	95207	EPBMFN5-D002P	91609
2.0 TFSI	1984	147	4	11.05-05.09	BWA		EPBMWN5-D003D	94436		

TOLEDO IV (KG3)

1.6 TDI	1598	66	4	06.13-06.15	CAYB		EPBMWT3-D024H	91171		
---------	------	----	---	-------------	------	--	---------------	-------	--	--

SKODA

FABIA I (6Y2, 6Y5, 6Y3)

1.4 TDI	1422	51	3	10.05-03.08	BNM		EPBMFN5-D003H	95299		
1.4 TDI	1422	55	3	04.03-12.07	AMF		EPBMFN5-D003H	95299	EPBMFN5-D002P	91609
1.4 TDI	1422	59	3	10.05-03.08	BNV		EPBMFN5-D003H	95299		
1.9 TDI	1896	74	4	01.00-07.04	ATD, AXR	Chass.>6Y2X040210; Chass.>6Y23532834	EPBMFN5-D003H	95299	EPBMFN5-D002P	91609
1.9 TDI	1896	74	4	01.00-07.04	ATD	Chass.<6Y2X040209; Chass.<6Y23532833	EPBMFN5-D005H	92204	EPBMFN5-D002P	91609
1.9 TDI RS	1896	96	4	06.03-03.08	ASZ		EPBMFN5-D002H	91692	EPBMFN5-D002P	91609
2.0	1984	85	4	12.99-03.08	AZL		EPBMFT5-D005P	90557		

FABIA II (542,545)

1.4 TDI	1422	51	3	02.07-03.10	BNM		EPBMFN5-D003H	95299		
1.4 TDI	1422	59	3	01.07-03.10	BMS, BNV		EPBMFN5-D003H	95299		



MAF



l kW
C
y
I



Type-Nº

Stock-Nº

Plug In
Alternative
Type-Nº

Plug In
Subtype

SKODA

FABIA II (542,545)

1.6 TDI	1598	55	4	04.10-12.14	CAYA		EPBMWT3-D024H	91171		
1.6 TDI	1598	66	4	03.10-12.14	CAYB		EPBMWT3-D024H	91171		
1.9 TDI	1896	77	4	04.07-03.10	BSW		EPBMFN5-D003H	95299	EPBMFN5-D002P	91609

KAROQ (NU7)

2.0 TDI	1968	110	4	07.17-	DFFA		EPBMFN4-V008H	95035		
2.0 TDI 4x4	1968	110	4	07.17-	DFFA		EPBMFN4-V008H	95035		
2.0 TDI 4x4	1968	140	4	07.17-	DFHA		EPBMFN4-V008H	95035		

KODIAQ (NS7, NV7)

2.0 TDI	1968	85	4	02.19-	DFGC		EPBMFN4-V008H	95035		
2.0 TDI	1968	110	4	10.16-	DBGC		EPBMFN4-V008H	95035		
2.0 TDI 4x4	1968	110	4	10.16-	DFGA, DBGC		EPBMFN4-V008H	95035		
2.0 TDI 4x4	1968	140	4	10.16-	DFHA		EPBMFN4-V008H	95035		

OCTAVIA I (1U2, 1U5)

1.6	1595	74	4	02.97-06.97	AEH, AKL		EPBMWN3-A016H	93176		
1.6	1595	74	4	02.97-12.07	AKL, AEH	; Chass.>1UV028928	EPBMWT4-D014H	93236		
1.6	1595	75	4	09.00-12.10	AVU, BFQ		EPBMWT4-D014H	93236		
1.8	1781	92	4	09.96-06.97	AGN		EPBMWN3-A016H	93176		
1.8	1781	92	4	09.96-07.00	AGN	; Chass.>1UV028928	EPBMFT5-D005P	90557		
1.8 20V	1781	92	4	07.98-07.00	AGN	; Chass.>1UV028928	EPBMFT5-D005P	90557		
1.8 T	1781	110	4	01.00-07.00	ARZ		EPBMFN5-D016H	96999	EPBMFN5-D002P	91609
1.8 T	1781	110	4	08.00-12.10	AUM, ARX		EPBMFN5-D012H	96277	EPBMFN5-D002P	91609
1.8 T 4x4	1781	110	4	05.01-05.06	ARX		EPBMFN5-D012H	96277		
RS 1.8 T	1781	132	4	05.01-01.06	AUQ		EPBMFN5-D012H	96277	EPBMFN5-D002P	91609
1.9 TDI	1896	66	4	07.98-03.10	AGR	Chass.<1UW133668	EPBMWN6-D029H	90628		
1.9 TDI	1896	66	4	07.98-03.10	ALH	Chass.<1U68826226; Chass.<1U6A031298	EPBMFN5-D005H	92204	EPBMFN5-D002P	91609
1.9 TDI	1896	66	4	07.98-03.10	ALH	Chass.>1U68826226; Chass.>1U6A031298	EPBMFN5-D003H	95299	EPBMFN5-D002P	91609
1.9 TDI 4x4	1896	66	4	08.00-02.06	AGR		EPBMFN5-D003H	95299	EPBMFN5-D002P	91609
1.9 TDI 4x4	1896	74	4	09.00-01.06	ATD		EPBMFN5-D003H	95299	EPBMFN5-D002P	91609
1.9 TDI	1896	74	4	10.05-12.10	AXR		EPBMFN5-D003H	95299		
1.9 TDI	1896	81	4	07.98-09.01	AHF	Chass.>1U68826226; Chass.>1U6A031298	EPBMFN5-D005H	92204	EPBMFN5-D002P	91609
1.9 TDI	1896	81	4	08.00-05.03	ASV	Chass.<1UW133668	EPBMWN6-D029H	90628		
1.9 TDI	1896	81	4	08.00-05.03	ASV	Chass.>1UW133669	EPBMFN5-D003H	95299	EPBMFN5-D002P	91609
1.9 TDI	1896	96	4	09.02-09.04	ASZ		EPBMFN5-D002H	91692	EPBMFN5-D002P	91609
2.0	1984	85	4	04.99-05.07	AZH, AQY, APK	; Chass.>1UV028928	EPBMFT5-D005P	90557		
2.0	1984	85	4	04.99-05.07	AZJ		EPBMFT5-D005P	90557		
2.0 4x4	1984	85	4	08.00-09.04	AZJ		EPBMFT5-D005P	90557		

OCTAVIA II (1Z3,1Z5)

1.8 TSI	1798	112	4	03.09-06.13	CDAB		EPBMWT5-A027H	96756		
1.8 TSI 4x4	1798	112	4	03.09-02.13	CDAB		EPBMWT5-A027H	96756		
1.8 TSI	1798	118	4	06.07-04.13	BZB		EPBMWN5-D027H	91976		
1.8 TSI	1798	118	4	06.07-04.13	CDAA		EPBMWT5-A027H	96756		
1.8 TSI 4x4	1798	118	4	11.08-02.13	CDAA		EPBMWT5-A027H	96756		



MAF

 l kW
C
Y
I

Type-N°

Stock-N°

 Plug In
Alternative
Type-N°

 Plug In
Alternative

SKODA
OCTAVIA II (1Z3,1Z5)

1.9 TDI	1896	77	4	06.04-12.10	BJB, BKC, BLS, BXE		EPBMFN5-D003H	95299	EPBMFN5-D002P	91609
1.9 TDI 4x4	1896	77	4	11.04-12.10	BKC, BLS, BXE		EPBMFN5-D003H	95299	EPBMFN5-D002P	91609
2.0 TDI	1968	81	4	03.10-06.13	CFHF, CLCA		EPBMFN4-V008H	95035		
2.0 TDI 4x4	1968	81	4	05.11-02.13	CFHF		EPBMFN4-V008H	95035		
2.0 TDI	1968	100	4	02.04-05.10	AZV		EPBMFN5-D002H	91692	EPBMFN5-D002P	91609
2.0 TDI 16V	1968	100	4	02.04-05.10	AZV		EPBMFN5-D002H	91692	EPBMFN5-D002P	91609
2.0 TDI 16V	1968	103	4	02.04-04.13	CFHC, CLCB		EPBMFN4-V008H	95035		
2.0 TDI	1968	103	4	11.05-05.10	BMM		EPBMFN5-D002H	91692	EPBMFN5-D002P	91609
2.0 TDI 16V	1968	103	4	11.05-04.13	BKD		EPBMFN5-D002H	91692	EPBMFN5-D002P	91609
2.0 TDI 4x4	1968	103	4	07.06-05.10	BMM		EPBMFN5-D002H	91692		
2.0 TDI 16V 4x4	1968	103	4	05.10-02.13	CFHC		EPBMFN4-V008H	95035		
2.0 TDI RS	1968	125	4	04.06-05.08	BMN		EPBMFN5-D002H	91692	EPBMFN5-D002P	91609
2.0 TDI RS	1968	125	4	04.06-02.13	CEGA		EPBMFN5-D001H	95207		
2.0 RS	1984	147	4	10.05-02.13	BWA		EPBMWN5-D003D	94436		
2.0 RS	1984	147	4	10.05-02.13	CCZA		EPBMWT5-A027H	96756		

OCTAVIA III (5E3, NL3, NR3, 5E5, 5E6)

2.0 TDI	1968	105	4	11.12-	CRVC, CKFB		EPBMFN4-V008H	95035		
2.0 TDI	1968	110	4	11.12-	CKFC, CRMB, DFFA, CYKA, DCYA		EPBMFN4-V008H	95035		
2.0 TDI 4x4	1968	110	4	09.14-	CKFC, CRMB, DFFA, DCYA		EPBMFN4-V008H	95035		
2.0 TDI RS	1968	135	4	05.13-	CUPA, CUNA, DJGA		EPBMFN4-V008H	95035		
2.0 TDI / TDI RS 4x4	1968	135	4	09.14-	CUPA, CUNA, DJGA		EPBMFN4-V008H	95035		

RAPID (NH1, NH3)

1.6 TDI	1598	66	4	08.13-	CAYB		EPBMWT3-D024H	91171		
---------	------	----	---	--------	------	--	---------------	-------	--	--

ROOMSTER PRAKTIK (5J,5J7)

1.4 TDI	1422	51	3	03.07-03.10	BNM		EPBMFN5-D003H	95299		
1.4 TDI	1422	59	3	09.06-03.10	BMS, BNV		EPBMFN5-D003H	95299		
1.6 TDI	1598	66	4	03.10-05.15	CAYB		EPBMWT3-D024H	91171		
1.9 TDI	1896	74	4	03.06-05.06	AXR		EPBMFN5-D003H	95299		
1.9 TDI	1896	77	4	09.06-03.10	BLS, BSW		EPBMFN5-D003H	95299	EPBMFN5-D002P	91609

SUPERB I (3U4)

1.8 T	1781	110	4	12.01-03.08	AWT		EPBMFN5-D025H	94062	EPBMFN5-D002P	91609
1.9 TDI	1896	74	4	08.02-10.05	AVB		EPBMFN5-D019H	95991	EPBMFN5-D002P	91609
1.9 TDI	1896	77	4	10.05-05.07	BSV		EPBMFN5-D002H	91692	EPBMFN5-D002P	91609
1.9 TDI	1896	85	4	01.07-03.08	BPZ		EPBMFN5-D002H	91692	EPBMFN5-D002P	91609
1.9 TDI	1896	96	4	12.01-03.08	AVF, AWX		EPBMFN5-D002H	91692	EPBMFN5-D002P	91609
2.0 TDI	1968	103	4	10.05-03.08	BSS		EPBMFN5-D002H	91692	EPBMFN5-D002P	91609
2.0	1984	85	4	12.01-03.08	AZM		EPBMWT4-D014H	93236		
2.5 TDI	2496	114	6	12.01-08.03	AYM		EPBMWN5-D014H	96884		
2.5 TDI	2496	120	6	06.03-03.08	BDG		EPBMWN5-D014H	96884		

SUPERB II (3T4,3T5)

1.8 TSI	1798	112	4	03.09-05.15	CDAB		EPBMWT5-A027H	96756		
1.8 TSI 4x4	1798	112	4	03.09-05.15	CDAB		EPBMWT5-A027H	96756		
1.8 TSI	1798	118	4	03.08-05.15	BZB		EPBMWN5-D027H	91976		
1.8 TSI	1798	118	4	03.08-05.15	CDAA		EPBMWT5-A027H	96756		



MAF
 e kW
 C
 Y
 I

Type-Nº

Stock-Nº

Plug In
Alternative
Type-NºPlug In
Subtype**SKODA****SUPERB II (3T4,3T5)**

1.8 TSI 4x4	1798	118	4	10.09-05.15	CDAА		EPBMWT5-A027H	96756		
1.9 TDI	1896	77	4	03.08-11.10	BLS, BXE		EPBMFN5-D003H	95299		
2.0 TDI	1968	103	4	03.08-05.10	BMP		EPBMFN5-D002H	91692	EPBMFN5-D002P	91609
2.0 TDI 16V	1968	103	4	01.09-05.15	BKD		EPBMFN5-D002H	91692	EPBMFN5-D002P	91609
2.0 TDI 16V	1968	103	4	01.09-05.15	CFFB, CLJA		EPBMFN4-V008H	95035	EPBMFN5-D002P	91609
2.0 TDI 16V 4x4	1968	103	4	11.10-05.15	CFFB		EPBMFN4-V008H	95035		
2.0 TDI	1968	125	4	07.08-05.15	CBBB		EPBMFN5-D001H	95207		
2.0 TDI	1968	125	4	07.08-05.15	CFGB		EPBMFN4-V008H	95035		
2.0 TDI 4x4	1968	125	4	09.08-05.15	CBBB		EPBMFN5-D001H	95207		
2.0 TDI 4x4	1968	125	4	09.08-05.15	CFGB		EPBMFN4-V008H	95035		
2.0 TSI	1984	147	4	05.10-05.15	CCZA		EPBMWT5-A027H	96756		
3.6 FSI 4x4	3597	191	6	11.08-05.15	CDVA		EPBMFT5-D040H	97032		
3.6 V6 4x4	3597	191	6	10.09-05.15	CDVA		EPBMFT5-D040H	97032		

SUPERB III (3V3, 3V5)

2.0 TDI	1968	110	4	03.15-	CRLB, DFEA, DFGA		EPBMFN4-V008H	95035		
2.0 TDI 4x4	1968	110	4	03.15-	CRLB, DFEA		EPBMFN4-V008H	95035		
2.0 TDI	1968	140	4	03.15-	DDAA, DFCA, DFHA		EPBMFN4-V008H	95035		
2.0 TDI 4x4	1968	140	4	03.15-	DDAA, DFCA, DFHA		EPBMFN4-V008H	95035		

YETI (5L)

1.8 TSI 4x4	1798	112	4	11.09-12.17	CDAB		EPBMWT5-A027H	96756		
1.8 TSI 4x4	1798	118	4	05.09-12.17	CDAА		EPBMWT5-A027H	96756		
2.0 TDI	1968	81	4	11.09-12.17	CFHA, CLCA, DFSA, CUUA		EPBMFN4-V008H	95035		
2.0 TDI 4x4	1968	81	4	11.09-12.17	CFHF, DFSA, CUUA		EPBMFN4-V008H	95035		
2.0 TDI 4x4	1968	103	4	05.09-12.17	CBDB		EPBMFN5-D001H	95207		
2.0 TDI 4x4	1968	103	4	05.09-12.17	CFHC, CLCB		EPBMFN4-V008H	95035		
2.0 TDI	1968	103	4	11.11-12.17	CFHC		EPBMFN4-V008H	95035		
2.0 TDI	1968	110	4	05.15-12.17	CUUB		EPBMFN4-V008H	95035		
2.0 TDI 4x4	1968	110	4	05.15-12.17	CUUB		EPBMFN4-V008H	95035		
2.0 TDI 4x4	1968	125	4	11.09-05.15	CEGA		EPBMFN5-D001H	95207		
2.0 TDI 4x4	1968	125	4	11.09-05.15	CFJA		EPBMFN4-V008H	95035		

SMART**FORFOUR (454)**

1.5 CDI	1493	50	3	09.04-06.06	OM639939		EPBMFT4-D050H	94911		
1.5 CDI	1493	70	3	09.04-06.06	OM639939		EPBMFT4-D050H	94911		

SSANGYONG**ACTYON I**

2.0 Xdi	1998	104	4	11.05-	D20DT		EPBMFT5-V002H	97685		
200 Xdi 4WD	1998	104	4	10.06-	D20DT		EPBMFT5-V002H	97685		

CHAIRMAN (HT_)

2.3	2295	110	4	07.97-	M111970, M111974		EPBMFT5-D009H	95803		
-----	------	-----	---	--------	------------------	--	---------------	-------	--	--

KORANDO (KJ)

2.0	1998	94	4	05.97-10.02	E20		EPBMFN4-D040H	96545		
-----	------	----	---	-------------	-----	--	---------------	-------	--	--



MAF



l kW
C
Y
I



Type-N°

Stock-N°

Plug In
Alternative
Type-N°

Plug In
Alternative
Type-N°

SSANGYONG

KORANDO (KJ)

2.3	2295	103	4	05.97-02.00	M111970		EPBMFN4-D040H	96545		
2.3	2295	105	4	01.99-11.06	E23M161		EPBMFN4-D040H	96545		
2.3	2295	110	4	01.02-06.06	M161970		EPBMFN4-D040H	96545		
3.2	3199	154	6	12.96-11.02	M104995		EPBMFT5-D041H	97661		
3.2	3199	156	6	01.99-02.00	M104995		EPBMFT5-D041H	97661	EPBMFT5-D003P	96835
3.2	3199	162	6	06.97-11.06	M104992		EPBMFT5-D041H	97661		

KORANDO CABRIO (KJ)

2.3	2295	103	4	11.97-02.00	E23M161		EPBMFN4-D040H	96545		
2.3	2295	105	4	02.99-11.06	E23M161		EPBMFN4-D040H	96545		
2.3	2295	110	4	01.02-06.06	M161970		EPBMFN4-D040H	96545		
3.2	3199	156	6	01.99-11.02	M104995		EPBMFT5-D041H	97661		
3.2	3199	162	6	06.97-11.06	M104992		EPBMFT5-D041H	97661		

KYRON

2.0 Xdi 4x4	1998	101	4	05.05-	D20DT	Euro5	EPBMFT5-V002H	97685		
2.0 Xdi 4x4	1998	104	4	05.05-	D20DT		EPBMFT5-V002H	97685		
2.0 Xdi	1998	104	4	09.07-	D20DT		EPBMFT5-V002H	97685		

MUSSO (FJ)

2.0	1998	93	4	10.96-05.05	E20		EPBMFN4-D040H	96545		
2.3	2295	103	4	10.96-11.02	M111970		EPBMFN4-D040H	96545		
2.3	2295	110	4	04.03-08.06	E23M161		EPBMFN4-D040H	96545		

REXTON / REXTON II (GAB_)

2.7 Xdi	2696	121	5	03.06-08.06	D27DT		EPBMFT5-V002H	97685		
2.7 D 4x4	2696	137	5	06.06-	D27DTP		EPBMFT5-V002H	97685		
3.2 RX320 4x4	3199	162	6	03.06-	G32D		EPBMFT5-V002H	97685		

REXTON W / REXTON

2.7 Xdi All-wheel Drive	2696	121	5	07.12-	D27DT	Euro4	EPBMFT5-V002H	97685		
2.7 Xdi All-wheel Drive	2696	137	5	10.12-	D27DTP	Euro4	EPBMFT5-V002H	97685		

RODIUS

2.7 Xdi	2696	120	5	05.05-	D27DT	Euro4	EPBMFT5-V002H	97685		
2.7 Xdi 4WD	2696	120	5	05.05-	D27DT	Euro4	EPBMFT5-V002H	97685		

RODIUS II | TURISMO

3.2 4WD	3199	162	6	07.13-	G32D	Euro3; Euro4	EPBMFT5-V002H	97685		
---------	------	-----	---	--------	------	--------------	---------------	-------	--	--

SUBARU

TREZIA

1.3	1329	73	4	03.11-	1NR-FE, 1NR-FKE		EPBMFT5-V002D	97692		
-----	------	----	---	--------	-----------------	--	---------------	-------	--	--

SUZUKI

GRAND VITARA I (FT, HT)

2.0 HDI 110 16V 4x4	1997	80	4	07.01-09.05	RHW		EPBMWT5-A003H	93842		
2.0 HDI 110 4x4	1997	80	4	07.01-09.05	RHZ		EPBMWT5-A003H	93842		

GRAND VITARA II (JT, TE, TD)

1.6	1586	78	4	10.05-	M16A		EPBMWT5-A005D	93145		
-----	------	----	---	--------	------	--	---------------	-------	--	--



MAF



l kW
C
y
I



Type-Nº

Stock-Nº

Plug In
Alternative
Type-Nº

Plug In
Subtype

SUZUKI

GRAND VITARA II (JT, TE, TD)

1.6 Allrad	1586	78	4	04.05-	M16A		EPBMWT5-A005D	93145		
2.0	1995	103	4	10.05-02.15	J20A		EPBMWT5-A005D	93145		
2.0 Allrad	1995	103	4	10.05-02.15	J20A		EPBMWT5-A005D	93145		
2.4 Allrad	2393	122	4	01.09-	J24B		EPBMFT5-V002D	97692		
2.4 Allrad	2393	124	4	01.09-	J24B		EPBMFT5-V002D	97692		

IGNIS II (MH)

1.3 DDiS	1248	51	4	09.03-12.07	Z13DT		EPBMFT5-V029H	90502	EPBMFT5-V001P	93006
----------	------	----	---	-------------	-------	--	---------------	-------	---------------	-------

JIMNY (SN)

1.3 16V	1328	60	4	02.01-	M13A		EPBMWT5-A005D	93145		
1.3 16V 4WD	1328	60	4	02.01-	M13A		EPBMWT5-A005D	93145		
1.3	1328	63	4	08.04-	M13A		EPBMWT5-A005D	93145		
1.3 16V 4x4	1328	63	4	08.05-	M13A		EPBMWT5-A005D	93145		

KIZASHI (FR)

2.4	2393	131	4	10.10-	J24B		EPBMFT5-V002D	97692		
2.4 4x4	2393	131	4	10.10-	J24B		EPBMFT5-V002D	97692		

LIANA (ER, RH_)

1.6	1586	76	4	03.02-	M16A		EPBMWT5-A005D	93145		
1.6 4WD	1586	76	4	03.02-	M16A		EPBMWT5-A005D	93145		
1.6 4WD	1586	78	4	04.02-	M16A		EPBMWT5-A005D	93145		
1.6 i	1586	78	4	04.02-	M16A		EPBMWT5-A005D	93145		
1.6	1586	79	4	01.05-	M16A		EPBMWT5-A005D	93145		
1.6 4WD	1586	79	4	01.05-12.07	M16A		EPBMWT5-A005D	93145		

SPLASH (EX)

1.3 CDTi	1248	55	4	01.08-	D13A, Z13DTJ		EPBMFN4-V031H	96741		
----------	------	----	---	--------	--------------	--	---------------	-------	--	--

SWIFT III (MZ, EZ)

1.3 DDiS	1248	51	4	04.08-	Z13DT	; Chass.<00500000	EPBMFT5-V029H	90502	EPBMFT5-V001P	93006
1.3 DDiS	1248	55	4	04.08-	Z13DTJ		EPBMFT5-V029H	90502		
1.3 4x4	1328	66	4	01.06-	M13A		EPBMWT5-A014D	90205		
1.3	1328	67	4	02.05-06.15	M13A		EPBMWT5-A014D	90205		
1.3	1328	68	4	02.05-	M13A		EPBMWT5-A014D	90205		
1.3 4x4	1328	68	4	02.05-	M13A		EPBMWT5-A014D	90205		
1.3 LPG	1328	68	4	09.08-12.10	M13A		EPBMWT5-A014D	90205		
1.5	1490	75	4	02.05-	M15A		EPBMWT5-A014D	90205		
1.6	1586	92	4	05.06-	M16A		EPBMWT5-A014D	90205		

SWIFT IV (FZ, NZ)

1.3 DDiS	1248	55	4	10.10-	D13A, D13AA		EPBMFT4-V004H	90957		
----------	------	----	---	--------	-------------	--	---------------	-------	--	--

SX4 (EY, GY, RW)

1.5	1490	73	4	06.06-07.10	M15A		EPBMWT5-A014D	90205		
1.5	1490	73	4	06.06-07.10	M15A	; Vehicle Production Country:JPN	EPBMFT5-V002D	97692		



MAF



l kW
C
Y
I



Type-N°

Stock-N°

Plug In
Alternative
Type-N°

Plug In
Subtype

SUZUKI

SX4 (EY, GY, RW)

1.5 VVTi	1490	81	4	07.07-12.15	M15A		EPBMWT5-A014D	90205		
1.5 VVT	1490	82	4	07.10-	M15A		EPBMWT5-A014D	90205		
1.5 VVT	1490	82	4	07.10-	M15A	; Vehicle Production Country:JPN	EPBMFT5-V002D	97692		
1.5 VVT 4x4	1490	82	4	07.10-	M15A		EPBMWT5-A014D	90205		
1.6 VVT	1586	79	4	06.06-	M16A		EPBMWT5-A014D	90205		
1.6 VVT	1586	79	4	06.06-	M16A	; Vehicle Production Country:JPN	EPBMFT5-V002D	97692		
1.6 VVT 4x4	1586	79	4	06.06-	M16A		EPBMWT5-A014D	90205		
1.6 VVT 4x4	1586	79	4	06.06-	M16A	; Vehicle Production Country:JPN	EPBMFT5-V002D	97692		
1.6	1586	79	4	10.07-	M16A		EPBMWT5-A014D	90205		
1.6 AWD	1586	79	4	10.07-12.11	M16A		EPBMWT5-A014D	90205		
1.6 VVT 4x4	1586	82	4	07.09-	M16A	; Chass.<TSME-YB21S00450000; Chass.<TSME-YB21S00680000	EPBMWT5-A014D	90205		
1.6 VVT	1586	82	4	11.10-12.15	M16A	; Chass.>TSME-YB21S00680000	EPBMWT5-A014D	90205		
1.6	1586	88	4	10.07-	M16A		EPBMWT5-A014D	90205		
1.6 VVT	1586	88	4	07.09-	M16A		EPBMWT5-A014D	90205		
1.6 VVT	1586	88	4	07.09-	M16A	; Vehicle Production Country:JPN	EPBMFT5-V002D	97692		
1.6 VVT 4x4	1586	88	4	07.09-	M16A		EPBMWT5-A014D	90205		
1.6 VVT 4x4	1586	88	4	07.09-	M16A	; Vehicle Production Country:JPN	EPBMFT5-V002D	97692		
1.9 DDiS	1910	88	4	06.06-	D19AA		EPBMFN4-V026H	94497		
1.9 DDiS	1910	88	4	06.06-	D19AA		EPBMFN4-V010H	97588		
1.9 DDiS 4x4	1910	88	4	06.06-	D19AA		EPBMFN4-V026H	94497		
1.9 DDiS 4x4	1910	88	4	06.06-	D19AA		EPBMFN4-V010H	97588		
2.0 DDiS	1956	99	4	07.09-	D20AA		EPBMFT4-V004H	90957		
2.0 DDiS 4x4	1956	99	4	07.09-	D20AA		EPBMFT4-V004H	90957		

WAGON R

1.3 DDiS	1248	51	4	09.03-03.06	Z13DT		EPBMFT5-V001P	93006		
1.3	1328	65	4	09.03-12.10	M13A		EPBMWT5-A014D	90205		
1.3	1328	69	4	09.03-	M13A		EPBMWT5-A014D	90205		
1.3 4WD	1328	69	4	09.03-	M13A		EPBMWT5-A014D	90205		

TATA

INDICA | B-LINE

D 1.4	1405	37	4	07.03-02.08	475DL		EPBMFT5-V010H	96310	EPBMFT5-V001P	93006
1.4 D	1405	39	4	10.98-02.08	475DL		EPBMFT5-V001P	93006		



MAF



l kW
C
y
I



Type-Nº

Stock-Nº

Plug In
Alternative
Type-Nº

Plug In
Subtype

TATA

INDIGO (4_V2)

1.4 D	1405	46	4	01.03-	475DL		EPBMFT5-V010H	96310	EPBMFT5-V001P	93006
-------	------	----	---	--------	-------	--	---------------	-------	---------------	-------

TOYOTA

AURIS (_E15_) | COROLLA

1.33 Dual-VVTi	1329	73	4	01.10-09.12	1NR-FE		EPBMFT5-V002D	97692		
1.33 Dual-VVTi	1329	74	4	05.09-09.12	1NR-FE		EPBMFT5-V002D	97692		
1.4 D-4D	1364	66	4	03.07-02.09	1ND-TV		EPBMWT5-A014D	90205		
1.4 D-4D	1364	66	4	12.08-09.12	1ND-TV		EPBMWT5-V012D	95034		
1.4	1398	71	4	03.07-09.12	4ZZ-FE		EPBMWT5-A006D	91258		
1.6	1598	91	4	03.07-09.12	1ZR-FE		EPBMWT5-A006D	91258		
1.6	1598	91	4	12.08-08.12	1ZR-FE	; Vehicle Production Country:EU,JPN	EPBMFT5-V002D	97692		
1.6	1598	97	4	05.09-09.12	1ZR-FAE		EPBMFT5-V002D	97692		
1.8 Hybrid	1798	73	4	09.10-09.12	2ZR-FXE		EPBMFT5-V002D	97692		
1.8	1798	100	4	10.06-09.12	2ZR-FAE, 2ZR-FE		EPBMWT5-A006D	91258		
1.8	1798	108	4	02.09-09.12	2ZR-FAE		EPBMFT5-V002D	97692		
2.0 D-4D	1998	93	4	10.06-12.08	1AD-FTV		EPBMWT5-A014D	90205		
2.0 D-4D	1998	93	4	03.09-09.12	1AD-FTV		EPBMWT5-V012D	95034		
2.2 D	2231	130	4	11.06-03.09	2AD-FHV		EPBMWT5-A014D	90205		
2.2 D	2231	130	4	03.09-09.12	2AD-FHV		EPBMWT5-V012D	95034		

AURIS (_E18_)

1.3	1329	73	4	10.12-12.18	1NR-FE		EPBMFT5-V002D	97692		
1.6	1598	97	4	10.12-12.18	1ZR-FAE		EPBMFT5-V002D	97692		
1.8 Hybrid	1798	73	4	10.12-12.18	2ZR-FXE		EPBMFT5-V002D	97692		

AVENSIS (_T22_)

1.6	1598	81	4	07.00-02.03	3ZZ-FE		EPBMWT5-A014D	90205		
1.6 VVT-i	1598	81	4	10.00-02.03	3ZZ-FE		EPBMWT5-A014D	90205		
1.8	1794	95	4	10.00-02.03	1ZZ-FE		EPBMWT5-A014D	90205		
1.8 VVT-i	1794	95	4	10.00-02.03	1ZZ-FE		EPBMWT5-A014D	90205		
2.0 D-4D	1995	81	4	10.99-02.03	1CD-FTV		EPBMWT5-A004D	91831		
2.0 D	1995	85	4	09.02-02.03	1CD-FTV		EPBMWT5-A004D	91831		

AVENSIS (_T25_)

1.6 VVT-i	1598	81	4	04.03-11.08	3ZZ-FE		EPBMWT5-A014D	90205		
1.8	1794	95	4	03.03-10.08	1ZZ-FE		EPBMWT5-A014D	90205		
2.0 D-4D	1995	85	4	04.03-11.08	1CD-FTV		EPBMWT5-A004D	91831		
2.0 D-4D	1998	93	4	03.06-10.08	1AD-FTV		EPBMWT5-A014D	90205		
2.0	1998	108	4	03.03-11.08	1AZFSE		EPBMWT5-A014D	90205		
2.0 VVTi	1998	114	4	01.03-11.08	1AZFE		EPBMWT5-A014D	90205		
2.2 D-4D	2231	110	4	10.05-11.08	2AD-FTV		EPBMWT5-A014D	90205		



MAF



l kW C Y I



Type-Nº

Stock-Nº

Plug In Alternative Type-Nº

Plug In Stock-Nº

TOYOTA

AVENSIS (_T25_)

2.2 D-CAT	2231	130	4	07.05-11.08	2AD-FHV		EPBMWT5-A014D	90205		
2.4	2362	120	4	10.03-10.08	2AZ-FSE		EPBMWT5-A014D	90205		
2.4	2362	125	4	09.03-11.08	2AZ-FSE		EPBMWT5-A014D	90205		

AVENSIS (_T27_)

1.6	1598	97	4	02.09-10.18	1ZR-FAE		EPBMFT5-V002D	97692		
1.8	1798	108	4	02.09-10.18	2ZR-FAE		EPBMFT5-V002D	97692		
2.0	1987	112	4	02.09-10.18	3ZR-FAE, 3ZR-FE		EPBMFT5-V002D	97692		
2.0 D-4D	1998	93	4	02.09-10.18	1AD-FTV		EPBMWT5-V012D	95034		
2.2 D-4D	2231	130	4	02.09-10.18	2AD-FHV		EPBMWT5-V012D	95034		

AVENSIS VERSO (_M2_) | VERSO SPORTVAN | IPSUM

2.0 D	1995	85	4	08.01-08.05	1CD-FTV		EPBMWT5-A004D	91831		
2.0	1998	110	4	08.01-11.09	1AZ-FE		EPBMWT5-A014D	90205		
2.4	2362	115	4	08.01-08.07	2AZ-FE		EPBMWT5-A014D	90205		
2.4 4WD	2362	115	4	11.03-08.06	2AZ-FE		EPBMWT5-A014D	90205		

AYGO (_B1_)

1.4 HDi	1398	40	4	07.05-08.10	2WZ-TV		EPBMWT4-A009H	92423		
---------	------	----	---	-------------	--------	--	---------------	-------	--	--

CAMRY SALOON (_V3_)

3.0	2995	137	6	08.01-11.06	1MZ-FE		EPBMWT5-A014D	90205		
-----	------	-----	---	-------------	--------	--	---------------	-------	--	--

CAMRY SALOON (_V5_)

2.5	2494	133	4	09.11-	2AR-FE		EPBMFT5-V002D	97692		
3.5	3456	204	6	09.11-12.17	2GR-FE		EPBMFT5-V002D	97692		

CELICA COUPE (_T23_)

1.8 16V VT-i	1794	105	4	08.99-07.05	1ZZ-FE		EPBMWT5-A014D	90205		
1.8 16V TS	1796	141	4	08.99-09.05	2ZZ-GE		EPBMWT5-A014D	90205		

COROLLA (_E11_)

2.0 D-4D	1995	66	4	09.00-01.02	1CD-FTV		EPBMWT5-A004D	91831		
----------	------	----	---	-------------	---------	--	---------------	-------	--	--

COROLLA (_E12_)

1.4 D	1364	66	4	07.04-02.07	1ND-TV		EPBMWT5-A014D	90205		
1.4 D4-D	1364	66	4	06.04-10.07	1ND-TV		EPBMWT5-A014D	90205		
1.4 D-4D	1364	66	4	06.04-10.06	1ND-TV		EPBMWT5-A014D	90205		
1.4 VVT-i	1398	71	4	01.02-02.07	4ZZ-FE		EPBMWT5-A014D	90205		
1.6 VVT-i	1598	81	4	01.02-08.07	3ZZ-FE		EPBMWT5-A014D	90205		
1.8 VVT-i	1794	99	4	12.01-05.04	1ZZ-FE		EPBMWT5-A014D	90205		
1.8 WVTL-i TS	1796	141	4	11.01-02.07	2ZZ-GE		EPBMWT5-A014D	90205		
1.8 WVTL-i TS	1796	160	4	10.05-12.06	2ZZ-GE		EPBMWT5-A014D	90205		
1.8 WVTL-i TS	1796	165	4	02.05-02.07	2ZZ-GE		EPBMWT5-A014D	90205		
2.0 D-4D	1995	66	4	01.02-02.07	1CD-FTV		EPBMWT5-A004D	91831		
2.0 D-4D	1995	81	4	01.02-12.06	1CD-FTV		EPBMWT5-A004D	91831		
2.0 D-4D	1995	85	4	04.04-02.07	1CD-FTV		EPBMWT5-A004D	91831		



MAF



l kW
C
Y
I



Type-Nº

Stock-Nº

Plug In
Alternative
Type-Nº

Plug In
Subtype

TOYOTA

COROLLA SALOON (_E15_) | ALTIS | COROLLA / COROLLAQUEST

1.3	1329	74	4	12.08-06.13	1NR-FE		EPBMFT5-V002D	97692		
1.4 D-4D	1364	66	4	10.06-12.08	1ND-TV		EPBMWT5-A014D	90205		
1.4 VVT-i	1398	71	4	11.06-02.07	4ZZ-FE		EPBMWT5-A014D	90205		
1.6 Dual VVTi	1598	91	4	12.08-04.13	1ZR-FE		EPBMFT5-V002D	97692		
1.6	1598	97	4	11.06-04.13	1ZR-FAE, 1ZR-FE		EPBMFT5-V002D	97692		
1.8	1798	100	4	10.06-07.14	2ZR-FE		EPBMFT5-V002D	97692		
2.0 D-4D	1998	93	4	11.06-01.09	1AD-FTV		EPBMWT5-A014D	90205		

COROLLA VERSO (ZER_, ZZE12_, R1_)

1.6	1598	81	4	04.04-03.09	3ZZ-FE		EPBMWT5-A014D	90205		
1.6	1598	81	4	08.07-03.09	3ZZ-FE		EPBMWT5-A006D	91258		
1.8	1794	95	4	04.04-03.09	1ZZ-FE		EPBMWT5-A014D	90205		
1.8	1794	95	4	08.07-03.09	1ZZ-FE		EPBMWT5-A006D	91258		
2.0 D-4D	1995	85	4	04.04-03.09	1CD-FTV		EPBMWT5-A004D	91831		
2.2 D-4D	2231	100	4	10.05-03.09	2AD-FTV		EPBMWT5-A014D	90205		
2.2 D-4D	2231	130	4	10.05-03.09	2AD-FHV		EPBMWT5-A014D	90205		

CROWN (CRS_, JZS_, GRS18_, UZS_)

3.0	2994	170	6	09.04-02.08	3GR-FE	; Vehicle Production Country:CHN	EPBMFT5-V002D	97692		
-----	------	-----	---	-------------	--------	----------------------------------	---------------	-------	--	--

FJ CRUISER (GSJ1_)

4.0	3956	176	6	06.05-08.09	1GR-FE		EPBMWT5-A014D	90205		
4.0 4WD	3956	176	6	06.05-08.09	1GR-FE		EPBMWT5-A014D	90205		
4.0	3956	178	6	01.06-12.11	1GR-FE		EPBMWT5-A014D	90205		
4.0 4WD	3956	203	6	06.05-08.09	1GR-FE		EPBMWT5-A014D	90205		

HILUX VI PICKUP (_N1_)

2.5 D-4D	2494	65	4	11.01-07.05	2KD-FTV		EPBMWT5-A014D	90205		
2.5 D-4D 4WD	2494	75	4	11.01-07.05	2KD-FTV		EPBMWT5-A014D	90205		

HILUX VII PICKUP (_N1_, _N2_, _N3_) | HILUX VIGO

2.0	1998	100	4	06.05-05.15	1TR-FE		EPBMWT5-A014D	90205		
2.5 D-4D	2494	65	4	08.05-10.06	2KD-FTV		EPBMWT5-A014D	90205		
2.5 D 4WD	2494	75	4	03.05-05.15	2KD-FTV		EPBMWT5-A014D	90205		
2.5 D-4D	2494	75	4	03.05-05.15	2KD-FTV		EPBMWT5-A014D	90205		
2.5 D-4D 4WD	2494	88	4	06.06-05.15	2KD-FTV		EPBMWT5-A014D	90205		
2.5 D-4D	2494	88	4	05.11-05.15	2KD-FTV		EPBMWT5-A014D	90205		
2.5 D-4D 4WD	2494	94	4	11.04-12.05	2KD-FTV		EPBMWT5-A014D	90205		
2.5 D-4D	2494	106	4	01.10-05.15	2KD-FTV	; RPO=22204-0L010; Type:Hilux	EPBMWT5-A014D	90205		
2.7	2694	118	4	08.05-05.15	2TR-FE		EPBMWT5-A014D	90205		
2.7 4WD	2694	118	4	08.05-05.15	2TR-FE		EPBMWT5-A014D	90205		
3.0 D-4D 4WD	2982	126	4	08.05-09.15	1KD-FTV	; RPO=22204-0L010; Type:Hilux	EPBMWT5-A014D	90205		



MAF



l kW
C
Y
I



Type-Nº

Stock-Nº

Plug In
Alternative
Type-Nº

Plug In
Subtype

TOYOTA

HILUX VII PICKUP (_N1_, _N2_, _N3_) | HILUX VIGO

3.0 D	2982	126	4	08.06-05.15	1KD-FTV		EPBMWT5-A014D	90205		
3.0 D-4D 4WD	2982	145	4	05.08-12.12	1KD-FTV		EPBMWT5-A014D	90205		

IQ (_J1_)

1.3	1329	72	4	05.09-12.15	1NR-FE		EPBMFT5-V002D	97692		
1.4 D-4D	1364	66	4	01.09-12.15	1ND-TV		EPBMWT5-V012D	95034		

LAND CRUISER 100 (_J1_) | LAND CRUISER AMAZON | PRADO

4.2 TD	4164	150	6	01.98-08.07	1HD-FTE		EPBMWT5-A004D	91831		
--------	------	-----	---	-------------	---------	--	---------------	-------	--	--

LAND CRUISER 200 (_J2_)

4.0	3956	176	6	01.10-01.12	1GR-FE		EPBMWT5-A014D	90205		
-----	------	-----	---	-------------	--------	--	---------------	-------	--	--

LAND CRUISER 90 (_J9_) | LAND CRUISER PRADO | LAND CRUISER COLORADO

3.0 D-4D 4WD	2982	120	4	08.00-08.02	1KD-FTV		EPBMWT5-A014D	90205		
--------------	------	-----	---	-------------	---------	--	---------------	-------	--	--

LAND CRUISER PRADO (_J12_)

3.0 D-4D	2982	120	4	09.02-08.09	1KD-FTV		EPBMWT5-A014D	90205		
3.0 D-4D	2982	122	4	07.04-08.09	1KD-FTV		EPBMWT5-A014D	90205		
3.0 D-4D	2982	127	4	09.02-12.10	1KD-FTV		EPBMWT5-A014D	90205		
3.0 D-4D	2982	150	4	08.06-07.09	1KD-FTV		EPBMWT5-A014D	90205		
4.0	3956	179	6	09.02-08.10	1GR-FE		EPBMWT5-A014D	90205		
4.0	3956	183	6	12.02-12.10	1GR-FE		EPBMWT5-A014D	90205		
4.0 V6 VVT-i	3956	207	6	01.03-07.09	1GR-FE		EPBMWT5-A014D	90205		

LAND CRUISER PRADO (_J15_)

4.0 V6 VVTi	3956	183	6	11.12-	1GR-FE		EPBMFT5-V002D	97692		
4.0 V6 VVTi	3956	203	6	01.10-	1GR-FE		EPBMFT5-V002D	97692		
4.0 V6 Dual VVTi	3956	205	6	08.09-	1GR-FE		EPBMFT5-V002D	97692		
4.0 V6 VVT-i	3956	207	6	08.09-	1GR-FE		EPBMFT5-V002D	97692		

MR2 III (ZZW3_)

1.8 16V VT-i	1794	103	4	10.99-06.07	1ZZ-FE		EPBMWT5-A014D	90205		
--------------	------	-----	---	-------------	--------	--	---------------	-------	--	--

PREVIA II (_R3_) | ESTIMA | PREVIA / ESTIMA

2.0 D-4D	1995	85	4	03.01-01.06	1CD-FTV		EPBMWT5-A004D	91831		
2.4	2362	115	4	02.00-02.06	2AZ-FE		EPBMWT5-A014D	90205		

PRIUS (_W3_)

1.8 Hybrid	1798	73	4	06.08-	2ZR-FXE		EPBMFT5-V002D	97692		
------------	------	----	---	--------	---------	--	---------------	-------	--	--

PRIUS LIFTBACK (_W2_)

1.5 Hybrid	1497	57	4	09.03-12.09	1NZ-FXE		EPBMWT5-A014D	90205		
------------	------	----	---	-------------	---------	--	---------------	-------	--	--

PRIUS PLUS (_W4_) | GRAND PRIUS +

1.8 Hybrid	1798	73	4	05.11-	2ZR-FXE		EPBMFT5-V002D	97692		
------------	------	----	---	--------	---------	--	---------------	-------	--	--

PRIUS SALOON (_W1_)

1.5 Hybrid	1497	53	4	05.00-01.04	1NZ-FXE		EPBMWT5-A005D	93145		
------------	------	----	---	-------------	---------	--	---------------	-------	--	--

PROACE BUS (MDZ_)

2.0 D	1997	110	4	02.16-	4WZ-FTV		EPBMWN4-A024H	90997		
2.0 D	1997	130	4	02.16-	4WZ-FHV		EPBMWN4-A024H	90997		



MAF



l kW
C
Y
I



Type-N°

Stock-N°

Plug In
Alternative
Type-N°

Plug In
Subtype

TOYOTA

PROACE VAN (MDX_)

2.0 D	1997	94	4	06.13-03.16	4WZFTW		EPBMWN4-A024H	90997		
2.0 D	1997	120	4	06.13-03.16	4WZFHV		EPBMWN4-A024H	90997		

PROACE VAN (MDZ_)

2.0 D	1997	90	4	02.16-	4WZFTV		EPBMWN4-A024H	90997		
2.0 D	1997	110	4	02.16-	4WZFTV		EPBMWN4-A024H	90997		
2.0 D	1997	130	4	02.16-	4WZFHV		EPBMWN4-A024H	90997		

RAV 4 II (_A2_)

1.8	1794	92	4	08.00-11.05	1ZZFE		EPBMWT5-A014D	90205		
2.0 D 4WD	1995	85	4	05.01-11.05	1CD-FTV		EPBMWT5-A004D	91831		
2.0 4WD	1998	110	4	05.00-11.05	1AZFE		EPBMWT5-A014D	90205		
2.4 4WD	2362	112	4	08.03-11.05	2AZFE		EPBMWT5-A014D	90205		

RAV 4 III (_A3_)

2.0	1987	109	4	03.09-12.12	3ZR-FAE		EPBMFT5-V002D	97692		
2.0 4WD	1987	109	4	03.09-12.12	3ZR-FAE		EPBMFT5-V002D	97692		
2.0	1987	116	4	12.08-12.12	3ZR-FAE		EPBMFT5-V002D	97692		
2.0 4WD	1987	116	4	12.08-12.12	3ZR-FAE		EPBMFT5-V002D	97692		
2.0 4WD	1998	112	4	02.06-06.13	1AZFE		EPBMWT5-A006D	91258		
2.2 D 4WD	2231	98	4	11.05-12.08	2AD-FTV		EPBMWT5-A014D	90205		
2.2 D 4WD	2231	100	4	02.06-12.08	2AD-FTV		EPBMWT5-A014D	90205		
2.2 D 4WD	2231	130	4	02.06-12.08	2AD-FHV		EPBMWT5-A014D	90205		
2.2 D 4WD	2231	130	4	02.06-06.13	2AD-FHV		EPBMWT5-V012D	95034		

RAV 4 IV (_A4_)

2.0	1987	107	4	12.12-	3ZR-FE		EPBMFT5-V002D	97692		
2.0 4WD	1987	111	4	12.12-	3ZR-FAE		EPBMFT5-V002D	97692		

URBAN CRUISER (_P1_)

1.3	1329	73	4	01.09-03.16	1NR-FE		EPBMFT5-V002D	97692		
1.3	1329	74	4	04.09-03.16	1NR-FE		EPBMFT5-V002D	97692		
1.4 D-4D	1364	66	4	01.09-04.14	1ND-TV		EPBMWT5-V012D	95034		
1.4 D-4D 4WD	1364	66	4	01.09-04.14	1ND-TV		EPBMWT5-V012D	95034		

VERSO (_R2_)

1.6	1598	97	4	04.09-08.18	1ZR-FAE		EPBMFT5-V002D	97692		
1.8	1798	108	4	04.09-08.18	2ZR-FAE		EPBMFT5-V002D	97692		
2.0 D-4D	1998	93	4	04.09-08.18	1AD-FTV		EPBMWT5-V012D	95034		
2.2 D-4D	2231	110	4	04.09-08.18	2AD-FHV		EPBMWT5-V012D	95034		
2.2 D-CAT	2231	130	4	04.09-08.18	2AD-FHV		EPBMWT5-V012D	95034		

VERSO S (_P12_) | VERSO SPACE

1.3	1329	73	4	11.10-10.16	1NR-FE		EPBMFT5-V002D	97692		
-----	------	----	---	-------------	--------	--	---------------	-------	--	--

WISH MPV (_E2_)

1.8 4WD	1797	98	4	04.09-03.12	2ZR-FAE		EPBMFT5-V002D	97692		
---------	------	----	---	-------------	---------	--	---------------	-------	--	--



MAF



l kW
C
Y
I



Type-N°

Stock-N°

Plug In
Alternative
Type-N°

Plug In
Stock-N°

TOYOTA

WISH MPV (_E2_)

1.8	1798	106	4	04.09-	2ZR-FAE		EPBMFT5-V002D	97692		
2.0	1987	116	4	04.09-	3ZR-FAE		EPBMFT5-V002D	97692		

YARIS (_P1_) | YARIS/VITZ | ECHO

1.0	998	48	4	03.03-09.05	1SZ-FE		EPBMWT5-A014D	90205		
1.0	998	50	4	04.99-09.05	1SZ-FE		EPBMWT5-A014D	90205		
1.3	1298	64	4	04.02-09.05	2SZ-FE		EPBMWT5-A014D	90205		
1.3	1299	63	4	08.99-11.05	2NZ-FE		EPBMWT5-A014D	90205		
1.4 D-4D	1364	55	4	10.01-09.05	1ND-TV		EPBMWT5-A014D	90205		
1.5	1497	77	4	01.03-11.05	1NZ-FE		EPBMWT5-A014D	90205		
1.5	1497	78	4	04.01-09.05	1NZ-FE		EPBMWT5-A014D	90205		
1.5	1497	110	4	03.00-07.05	1NZ-FE		EPBMWT5-A014D	90205		

YARIS (_P13_) | YARIS/VITZ

1.3	1299	63	4	12.11-	2NZ-FE		EPBMWT5-A014D	90205		
1.3	1329	73	4	09.11-	1NR-FE, 1NR-FKE		EPBMFT5-V002D	97692		
1.5 Hybrid	1497	55	4	03.12-	1NZ-FXE		EPBMFT5-V002D	97692		

YARIS (_P9_)

1.3	1298	64	4	09.05-10.13	2NZ-FE, 2SZ-FE		EPBMWT5-A014D	90205		
1.3 VVT-i	1298	64	4	08.05-11.10	2SZ-FE		EPBMWT5-A014D	90205		
1.3 4WD	1298	64	4	08.07-11.10	2NZ-FE		EPBMWT5-A014D	90205		
1.3 VVT-i	1299	63	4	11.05-12.12	2NZ-FE, 2SZ-FE		EPBMWT5-A014D	90205		
1.33 VVT-i	1329	73	4	07.10-05.11	1NR-FE		EPBMFT5-V002D	97692		
1.33 VVT-i	1329	74	4	11.08-07.11	1NR-FE		EPBMFT5-V002D	97692		
1.4 D-4D	1364	66	4	08.05-11.08	1ND-TV		EPBMWT5-A014D	90205		
1.4 D-4D	1364	66	4	08.05-12.12	1ND-TV		EPBMWT5-V012D	95034		

YARIS VERSO (_P2_) | YARIS VERSO / FUN CARGO

1.3	1299	62	4	11.02-09.05	2NZ-FE		EPBMWT5-A014D	90205		
1.3	1299	63	4	08.99-10.02	2NZ-FE		EPBMWT5-A014D	90205		
1.4 D-4D	1364	55	4	09.00-09.05	1ND-TV		EPBMWT5-A014D	90205		
1.5	1497	77	4	03.00-09.05	1NZ-FE		EPBMWT5-A014D	90205		
1.5	1497	78	4	03.00-09.05	1NZ-FE		EPBMWT5-A014D	90205		

UAZ

2206

2.7 4x4	2693	82	4	05.14-	ZMZ409210		EPBMFT5-V039H	90466		
---------	------	----	---	--------	-----------	--	---------------	-------	--	--

3160

2.9 i	2890	88	4	08.97-12.03	UMZ421310		EPBMFT5-V039H	90466	EPBMFT5-V001P	93006
-------	------	----	---	-------------	-----------	--	---------------	-------	---------------	-------

VAUXHALL

ADAM (M13)

1.2	1229	51	4	10.12-02.19	A12XEL, B12XEL		EPBMFT5-T001D	94095		
-----	------	----	---	-------------	----------------	--	---------------	-------	--	--



MAF



l kW
C
Y
I



Type-Nº

Stock-Nº

Plug In
Alternative
Type-Nº

Plug In
Subtype

VAUXHALL

ADAM (M13)

1.4	1398	64	4	10.12-02.19	A14XEL, B14XEL		EPBMFT5-T001D	94095		
1.4	1398	74	4	10.12-02.19	A14XER, B14XER		EPBMFT5-T001D	94095		

AGILA MK I (A) (H00)

1.0 12V	973	43	3	09.00-09.04	Z10XE		EPBMFT5-V007H	97257	EPBMFT5-V001P	93006
1.0 12V	998	44	3	02.00-11.06	Z10XEP		EPBMFT5-V007H	97257	EPBMFT5-V001P	93006
1.2 16V	1199	55	4	09.00-09.04	Z12XE		EPBMFT5-V007H	97257	EPBMFT5-V001P	93006
1.2 16V Twinport	1229	59	4	07.04-11.06	Z12XEP		EPBMFT5-V007H	97257	EPBMFT5-V001P	93006

AGILA MK II (B) (H08)

1.3 CDTI	1248	55	4	01.08-11.14	D13A, Z13DTJ		EPBMFN4-V031H	96741		
----------	------	----	---	-------------	--------------	--	---------------	-------	--	--

AMPERA (R12)

EV 150	1398	111	4	03.12-	A14XFL		EPBMFT5-T001D	94095		
--------	------	-----	---	--------	--------	--	---------------	-------	--	--

ANTARA (L07)

2.0 CDTi	1991	93	4	08.06-04.15	Z20DM		EPBMFN4-V026H	94497		
2.0 CDTI	1991	110	4	08.06-04.15	Z20DMH		EPBMFN4-V026H	94497		
2.0 CDTI 4x4	1991	110	4	08.06-04.15	Z20DMH		EPBMFN4-V026H	94497		
2.0 CDTI 4x4	1991	110	4	08.06-04.15	Z20DMH		EPBMFN4-V010H	97588		

ASTRA MK III (F) (T92)

1.6 i	1598	55	4	09.91-03.01	C16NZ, E16NZ, X16SZR		EPBMWN4-A019H	92343		
1.8 i 16V	1796	85	4	01.94-02.98	C18XEL, X18XE		EPBMWN4-A019H	92343		
1.8 i 16V	1796	92	4	09.94-02.98	C18XE		EPBMWN4-A019H	92343		
1.8 16V	1799	85	4	11.94-03.01	X18XE, C18XEL		EPBMWN4-A019H	92343		
1.8 i 16V	1799	92	4	06.93-10.94	C18XE		EPBMWN4-A019H	92343		
2.0 i 16V	1998	100	4	01.94-02.98	X20XEV		EPBMWN4-A019H	92343		

ASTRA MK IV (G) (T98)

1.6	1598	55	4	02.98-09.00	X16SZR		EPBMWN4-A019H	92343		
1.6 16V	1598	74	4	09.98-05.05	Z16XEP		EPBMWT5-V010H	93933		
1.6 16V	1598	74	4	04.03-05.05	X16XEL, Z16XE		EPBMWT5-V010H	93933		
1.6 16V	1598	76	4	03.00-08.05	Z16XEP	; Chass.<78999999; Chass.<7G; Chass.<72999999; Chass.<75999999	EPBMWT5-V010H	93933		
1.6	1598	76	4	12.02-05.05	Z16XEP	; Chass.<78999999; Chass.<7G; Chass.<72999999; Chass.<75999999	EPBMWT5-V010H	93933		
1.7 DTI 16V	1686	55	4	02.00-05.05	Y17DT		EPBMFT5-V017H	90311		
1.7 CDTI 16V	1686	59	4	04.03-05.05	Z17DTL		EPBMFT5-V010H	96310	EPBMFT5-V001P	93006
1.7 TD	1700	50	4	02.98-08.00	X17DTL		EPBMFT5-V017H	90311		
1.8 16V	1796	85	4	02.98-07.04	X18XE1, Z18XEL		EPBMWT4-V002H	92668		
1.8 16V Dualfuel	1796	87	4	02.98-07.04	Z18XE		EPBMWT4-V002H	92668		
1.8 16V	1796	92	4	03.01-10.05	Z18XE		EPBMWT4-V002H	92668		



MAF



l kW
C
Y
I



Type-N°

Stock-N°

Plug In
Alternative
Type-N°

Plug In
Stock-N°

VAUXHALL

ASTRA MK IV (G) (T98)

2.0 DI	1995	60	4	02.98-05.05	Y20DTL	; Chass.<Y8999999; Chass.<YH999999; Chass.<Y6999999; Chass.<Y2999999; Chass.<Y5999999	EPBMFT5-V017H	90311		
2.0 DI	1995	60	4	02.98-05.05	Y20DTL	; Chass.>18000001; Chass.>1H000001; Chass.>16000001; Chass.>12000001; Chass.>15000001	EPBMFT5-V017H	90311	EPBMFT5-V001P	93006
2.0 DTI 16V	1995	74	4	02.98-07.04	Y20DTH	; Chass.18000001; Chass.>1H000001; Chass.>16000001; Chass.>12000001; Chass.>15000001; Chass.<28999999; Chass.<2H999999; Chass.<26999999; Chass.<22999999; Chass.<25999999	EPBMFT5-V017H	90311		
2.0 DTI 16V	1995	74	4	02.98-07.04	Y20DTH	; Chass.>18000001; Chass.>1H000001; Chass.>16000001; Chass.>12000001; Chass.>15000001; Chass.<28999999; Chass.<2H999999; Chass.<26999999; Chass.<22999999; Chass.<25999999	EPBMFT5-V001P	93006		
2.0 DTI 16V	1995	74	4	08.00-04.04	Y20DTH	; Chass.>38000001; Chass.>3H000001; Chass.>35000001; Chass.>36000001	EPBMFT5-V010H	96310		
2.0 16V	1998	100	4	02.98-05.05	X20XEV		EPBMWT4-V002H	92668		
2.0 16V Turbo	1998	140	4	09.00-08.05	Z20LET		EPBMFT5-V017H	90311		
2.0 SRI Turbo	1998	141	4	11.01-05.05	Z20LET		EPBMFT5-V017H	90311		
2.0 Turbo	1998	141	4	03.02-10.05	Z20LET		EPBMFT5-V017H	90311		
2.0	1998	147	4	09.02-10.05	Z20LER, Z20LET		EPBMFT5-V017H	90311		
2.0	1998	147	4	08.02-05.05	Z20LET		EPBMFT5-V017H	90311		
2.2 16V	2198	108	4	03.00-08.05	Z22SE		EPBMWN4-A019H	92343		

ASTRA MK V (H) (A04)

1.3 CDTI	1248	66	4	01.04-05.09	Z13DTH		EPBMFN4-V026H	94497		
1.3 CDTI	1248	66	4	01.04-05.09	Z13DTH		EPBMFN4-V010H	97588		
1.4	1364	66	4	01.04-05.09	Z14XEP		EPBMFT5-V007H	97257	EPBMFT5-V001P	93006
1.4 i 16V	1364	66	4	03.05-11.10	Z14XEP		EPBMFT5-V007H	97257	EPBMFT5-V001P	93006
1.6	1598	77	4	01.04-05.09	Z16XEP	; Chass.<78999999; Chass.<7G; Chass.<72999999; Chass.<75999999	EPBMWT5-V010H	93933		
1.6 Turbo	1598	132	4	09.06-09.09	Z16LET		EPBMFT5-V017H	90311	EPBMFT5-V001P	93006
1.6	1598	132	4	09.07-	Z16LET		EPBMFT5-V017H	90311		
1.6	1598	132	4	09.07-03.09	Z16LET		EPBMFT5-V001P	93006		
1.7 CDTI	1686	59	4	01.04-05.09	Z17DTL		EPBMFN4-V026H	94497		



MAF



l kW
C
Y
I



Type-Nº

Stock-Nº

Plug In
Alternative
Type-Nº

Plug In
Stock-Nº

VAUXHALL

ASTRA MK V (H) (A04)

1.7 CDTi	1686	59	4	01.04-11.06	Z17DTL		EPBMFT5-V010H	96310	EPBMFT5-V001P	93006
1.7 CDTi	1686	59	4	01.04-06.05	Z17DTL		EPBMFN4-V010H	97588		
1.7 CDTi	1686	74	4	01.04-05.09	Z17DTH		EPBMFN4-V026H	94497		
1.7 CDTi	1686	74	4	01.04-05.09	Z17DTH		EPBMFN4-V010H	97588		
1.7 CDTi	1686	81	4	01.04-05.09	Z17DTJ, A17DTJ		EPBMFT5-V006H	94366		
1.8	1796	92	4	01.04-05.09	Z18XE		EPBMWT4-V002H	92668		
1.8	1796	103	4	01.06-05.09	A18XER, Z18XER		EPBMFT4-V048H	95493		
1.8 i 16V	1796	103	4	03.07-11.10	A18XER, Z18XER		EPBMFT4-V048H	95493		
1.9 CDTi	1910	74	4	08.05-11.10	Z19DTL		EPBMFN4-V026H	94497		
1.9 CDTi	1910	74	4	08.05-11.10	Z19DTL		EPBMFN4-V010H	97588		
1.9 CDTi	1910	88	4	01.04-05.09	Z19DT		EPBMFN4-V026H	94497		
1.9 CDTi	1910	88	4	01.04-05.09	Z19DT		EPBMFN4-V010H	97588		
1.9 CDTi 16V	1910	88	4	01.04-05.09	Z19DTJ		EPBMFN4-V026H	94497		
1.9 CDTi 16V	1910	88	4	01.04-05.09	Z19DTJ		EPBMFN4-V010H	97588		
1.9 CDTi	1910	110	4	01.04-05.09	Z19DTH		EPBMFN4-V026H	94497		
1.9 CDTi	1910	110	4	01.04-05.09	Z19DTH		EPBMFN4-V010H	97588		
2.0 Turbo	1998	125	4	01.04-05.09	Z20LEL		EPBMFT5-V017H	90311		
2.0 Turbo	1998	125	4	01.04-05.09	Z20LEL		EPBMFT5-V001P	93006		
2.0	1998	125	4	02.06-11.10	Z20LEL		EPBMFT5-V017H	90311	EPBMFT5-V001P	93006
2.0 Turbo	1998	147	4	01.04-05.09	Z20LER		EPBMFT5-V017H	90311	EPBMFT5-V001P	93006
2.0 VXR	1998	176	4	02.09-11.10	Z20LEH		EPBMFT5-V001P	93006		
2.0 VXR	1998	176	4	02.09-11.10	Z20LEH	; Chass.<52999999	EPBMFT5-V020H	90244		
2.0 Turbo	1998	177	4	01.04-05.09	Z20LEH		EPBMFT5-V001P	93006		
2.0 Turbo	1998	177	4	01.04-05.09	Z20LEH	; Chass.62000001	EPBMFT5-V020H	90244		

ASTRA MK VI (J) (P10)

1.3 CDTi	1248	70	4	06.12-	A13DTE		EPBMFT5-T011H	92630		
1.4	1398	64	4	12.09-	A14XEL		EPBMFT5-T011H	92630		
1.4	1398	64	4	12.09-10.15	A14XEL		EPBMFT5-T001D	94095		
1.4	1398	74	4	10.10-12.16	A14XER, B14XER		EPBMFT5-T011H	92630		
1.4	1398	74	4	10.11-10.15	A14XER		EPBMFT5-T001D	94095		
1.4	1398	74	4	06.12-10.15	A14XER, B14XER		EPBMFT5-T001D	94095		
1.4 Turbo	1364	88	4	08.10-10.15	A14NEL		EPBMFT5-T001D	94095		
1.4 Turbo	1364	88	4	08.10-10.15	A14NEL	; Semi-automatic	EPBMFT5-T001D	94095		
1.4	1364	88	4	10.11-10.15	A14NEL, B14NEL		EPBMFT5-T001D	94095		
1.4 Turbo	1364	103	4	12.09-10.15	A14NET, B14NET, D14NET		EPBMFT5-T001D	94095		
1.4 Turbo	1364	103	4	12.09-10.15	A14NET, B14NET, D14NET	; Semi-automatic	EPBMFT5-T001D	94095		
1.4 Turbo	1364	103	4	10.10-10.15	A14NET		EPBMFT5-T001D	94095		
1.4 Turbo	1364	103	4	10.10-10.15	A14NET	; Semi-automatic	EPBMFT5-T001D	94095		



MAF



l kW
C
Y
I



Type-Nº

Stock-Nº

Plug In
Alternative
Type-Nº

Plug In
Subtype

VAUXHALL

ASTRA MK VI (J) (P10)

1.4	1364	103	4	10.11-10.15	A14NET, B14NET		EPBMFT5-T001D	94095		
1.4 Turbo	1364	103	4	06.12-10.15	A14NET		EPBMFT5-T001D	94095		
1.6 CDTi	1598	81	4	01.14-10.15	B16DTL		EPBMFT5-T001D	94095		
1.6	1598	85	4	10.10-10.15	A16XER, B16XER		EPBMFT5-T001D	94095		
1.6	1598	85	4	06.12-10.15	A16XER		EPBMFT5-T001D	94095		
1.6 CDTi	1598	100	4	01.14-10.15	B16DTH		EPBMFT5-T001D	94095		
1.6	1598	132	4	10.11-10.15	A16LET		EPBMFT5-T001D	94095		
1.6 Turbo	1598	132	4	06.12-10.15	A16LET		EPBMFT5-T001D	94095		
1.7 CDTi	1686	74	4	10.10-	A17DTL		EPBMFT5-T011H	92630		
1.7 CDTi	1686	81	4	10.10-10.15	A17DTC		EPBMFT5-T001D	94095		
1.7 CDTi	1686	81	4	10.11-	A17DTJ, A17DTE		EPBMFT5-T011H	92630		
1.7 CDTi	1686	81	4	06.12-	A17DTJ, A17DTC, A17DTE		EPBMFT5-T011H	92630		
1.7 CDTi	1686	92	4	10.10-	A17DTR		EPBMFT5-T011H	92630		
1.7 CDTi	1686	96	4	10.11-	A17DTF		EPBMFT5-T011H	92630		
1.7 CDTi	1686	96	4	06.11-	A17DTS, A17DTF		EPBMFT5-T011H	92630		
1.7 CDTi	1686	96	4	06.11-10.15	A17DTS		EPBMFT5-T001D	94095		
2.0 CDTi	1956	118	4	10.10-	A20DTH		EPBMFT5-T003H	91493		
2.0 CDTi	1956	121	4	08.11-	A20DTH		EPBMFT5-T003H	91493		
2.0 BiTurbo CDTi	1956	143	4	12.12-	A20DTR		EPBMFT5-T003H	91493		

ASTRA MK VII (K) (B16)

1.6 CDTi	1598	70	4	07.15-	B16DTE		EPBMFT5-T001D	94095		
1.6 CDTi	1598	81	4	07.15-	B16DTE, B16DTU, D16DTI		EPBMFT5-T001D	94095		
1.6 CDTi	1598	100	4	07.15-	B16DTH, D16DTH		EPBMFT5-T001D	94095		
1.6 CDTi	1598	118	4	11.15-	B16DTR		EPBMFT5-T001D	94095		

ASTRAVAN MK IV (G) (T98)

1.6 i	1598	55	4	08.98-09.00	X16SZR		EPBMWN4-A019H	92343		
1.7 DTI 16V	1686	55	4	04.01-08.06	Y17DT		EPBMFT5-V017H	90311		
1.7 CDTi	1686	59	4	04.04-08.06	Z17DTL		EPBMFT5-V010H	96310	EPBMFT5-V001P	93006
1.7 TD	1700	50	4	08.98-08.06	X17DTL		EPBMFT5-V017H	90311		
2.0 DI	1995	60	4	08.98-08.06	X20DTL		EPBMFT5-V017H	90311		
2.0 DTI	1995	74	4	04.04-08.06	Y20DTH		EPBMFT5-V017H	90311		

ASTRAVAN MK V (H) ESTATE VAN (A04)

1.3 CDTi	1248	66	4	08.05-	Z13DTH		EPBMFN4-V026H	94497		
1.3 CDTi	1248	66	4	08.05-	Z13DTH		EPBMFN4-V010H	97588		
1.4 i	1364	66	4	03.05-	Z14XEP		EPBMFT5-V007H	97257		
1.7 CDTi	1686	59	4	03.05-07.06	Z17DTL		EPBMFN4-V026H	94497		
1.7 CDTi	1686	59	4	03.05-07.06	Z17DTL		EPBMFN4-V010H	97588		
1.7 CDTi	1686	74	4	03.05-11.11	Z17DTH		EPBMFN4-V026H	94497		



MAFl kW
C
y
I

Type-N°

Stock-N°

Plug In
Alternative
Type-N°Plug In
Stock-N°**VAUXHALL****ASTRAVAN MK V (H) ESTATE VAN (A04)**

1.7 CDTi	1686	74	4	03.05-11.11	Z17DTH		EPBMFN4-V010H	97588		
1.7 CDTi	1686	81	4	06.11-12.13	Z17DTJ, A17DTJ		EPBMFT5-V006H	94366		
1.7 CDTi	1686	92	4	11.11-	A17DTR, Z17DTR		EPBMFT5-V006H	94366		
1.9 CDTi	1910	88	4	03.05-11.11	Z19DT		EPBMFN4-V026H	94497		
1.9 CDTi	1910	110	4	03.05-11.11	Z19DTH		EPBMFN4-V026H	94497		
1.9 CDTi	1910	110	4	03.05-11.11	Z19DTH		EPBMFN4-V010H	97588		

CALIBRA (C89)

2.0 i 16V	1998	100	4	06.90-07.97	X20XEV		EPBMWN4-A019H	92343		
2.0 i 16V 4x4	1998	100	4	02.94-07.97	X20XEV		EPBMWN4-A019H	92343		

CASCADE CONVERTIBLE (W13)

2.0 CDTi	1956	121	4	02.13-	A20DTH		EPBMFT5-T003H	91493		
2.0 CDTi	1956	125	4	07.15-	B20DTH		EPBMFT5-T001D	94095		
2.0 CDTi	1956	143	4	02.13-	A20DTR		EPBMFT5-T003H	91493		

CAVALIER MK III (J89)

2.0 i 16V	1998	100	4	09.92-08.95	X20XEV		EPBMWN4-A019H	92343		
2.0 SRi 16V	1998	100	4	09.92-08.95	X20XEV		EPBMWN4-A019H	92343		

COMBO MK II (C) (F25)

1.3 CDTi 16V	1248	51	4	09.04-09.06	Y13DT, Z13DT		EPBMFT5-V010H	96310		
1.3 CDTi 16V	1248	51	4	09.04-02.12	Z13DT		EPBMFT5-V010H	96310	EPBMFT5-V001P	93006
1.3 CDTi 16V	1248	55	4	07.06-02.12	Z13DTJ		EPBMFN4-V026H	94497		
1.3 CDTi 16V	1248	55	4	07.06-02.12	Z13DTJ		EPBMFN4-V010H	97588		
1.4	1364	66	4	10.04-09.10	Z14XEP		EPBMFT5-V007H	97257		
1.4 i 16V	1364	66	4	01.04-11.11	Z14XEP		EPBMFT5-V007H	97257		
1.4 16V	1389	66	4	10.01-05.07	Z14XE		EPBMFT5-V007H	97257		
1.7 DI 16V	1686	48	4	09.01-06.04	Y17DTL		EPBMFT5-V017H	90311		
1.7 DTi 16V	1686	55	4	10.01-02.12	Y17DT		EPBMFT5-V017H	90311		
1.7 CDTi 16V	1686	74	4	12.04-11.11	Z17DTH		EPBMFT5-V010H	96310	EPBMFT5-V001P	93006

COMBO MK III (D) (X12)

1.3 CDTi	1248	66	4	11.11-	A13FD		EPBMFT4-V004H	90957		
1.3 CDTi	1248	66	4	11.11-	A13FD		EPBMFN4-V017H	96226		
1.6 CDTi	1598	66	4	11.11-	A16FDL		EPBMFT4-V004H	90957		
1.6 CDTi	1598	66	4	11.11-	A16FDL		EPBMFT4-V004H	90957		
1.6 CDTi	1598	74	4	11.11-	A16FDH		EPBMFT4-V004H	90957		
1.6 CDTi	1598	77	4	11.11-	A16FDH		EPBMFT4-V004H	90957		
1.6 CDTi	1598	77	4	11.11-	A16FDH		EPBMFT4-V004H	90957		
2.0 CDTi	1956	99	4	11.11-	A20FD		EPBMFT4-V004H	90957		

CORSA MK I (B) (S93)

1.0 i 12V	973	40	3	11.96-09.00	X10XE		EPBMFT5-V007H	97257	EPBMFT5-V001P	93006
1.2 i 16V	1199	48	4	03.98-09.00	X12XE		EPBMFT5-V007H	97257	EPBMFT5-V001P	93006



MAF



l kW
C
Y
I



Type-N°

Stock-N°

Plug In
Alternative
Type-N°

Plug In
Stock-N°

VAUXHALL

CORSA MK II (C) (X01)

1.0 12V	973	43	3	09.00-10.03	Z10XE		EPBMFT5-V007H	97257	EPBMFT5-V001P	93006
1.0 12V	998	44	3	11.03-10.06	Z10XEP		EPBMFT5-V007H	97257	EPBMFT5-V001P	93006
1.2 16V	1199	55	4	09.00-04.04	Z12XE		EPBMFT5-V007H	97257	EPBMFT5-V001P	93006
1.2 16V Dualfuel	1199	55	4	08.01-06.06	Z12XE		EPBMFT5-V007H	97257		
1.2 16V	1229	59	4	07.04-11.06	Z12XEP		EPBMFT5-V007H	97257		
1.2 16V Dualfuel	1229	59	4	07.04-12.05	Z12XEP		EPBMFT5-V007H	97257		
1.2 Twinport	1229	59	4	07.04-10.06	Z12XEP		EPBMFT5-V007H	97257	EPBMFT5-V001P	93006
1.3 CDTI 16V	1248	52	4	08.00-09.06	Z13DT		EPBMFT5-V010H	96310	EPBMFT5-V001P	93006
1.4	1364	66	4	11.03-06.06	Z14XEP		EPBMFT5-V007H	97257		
1.4 Twinport	1364	66	4	06.03-10.06	Z14XEP		EPBMFT5-V007H	97257	EPBMFT5-V001P	93006
1.7 DI 16V	1686	48	4	09.00-06.06	Y17DTL		EPBMFT5-V017H	90311		
1.7 DTI 16V	1686	55	4	09.00-06.06	Y17DT		EPBMFT5-V017H	90311		
1.7 CDTI 16V	1686	74	4	08.00-09.06	Z17DTH		EPBMFT5-V010H	96310	EPBMFT5-V001P	93006
1.8 16V	1796	92	4	08.00-09.06	Z18XE		EPBMWT4-V002H	92668		

CORSA MK III (D) (S07)

1.0	998	44	3	08.06-08.14	A10XEP		EPBMFT5-T001D	94095		
1.0 i 12V	998	48	3	01.10-08.14	A10XEP		EPBMFT5-T001D	94095		
1.2	1229	51	4	06.10-08.14	A12XEL		EPBMFT5-T001D	94095		
1.2 i 16V	1229	63	4	12.09-08.14	A12XER		EPBMFT5-T001D	94095		
1.3 CDTI	1248	55	4	07.06-	A13DTC		EPBMFT5-T011H	92630		
1.3 CDTI	1248	55	4	07.06-	Z13DTJ		EPBMFN4-V026H	94497		
1.3 CDTI	1248	55	4	07.06-	Z13DTJ		EPBMFN4-V010H	97588		
1.3 CDTI	1248	66	4	07.06-	Z13DTH		EPBMFN4-V026H	94497		
1.3 CDTI	1248	66	4	08.06-08.14	Z13DTH		EPBMFN4-V010H	97588		
1.3 CDTI	1248	70	4	07.06-	A13DTE, Z13DTE, A13DTR		EPBMFT5-T011H	92630		
1.4	1398	74	4	01.10-08.14	A14XER		EPBMFT5-T001D	94095		
1.6 SRi	1598	110	4	05.07-08.14	A16LEL		EPBMFT5-V017H	90311	EPBMFT5-V001P	93006
1.6 VXR	1598	141	4	11.06-08.14	A16LER, B16LER, Z16LER		EPBMFT5-V017H	90311	EPBMFT5-V001P	93006
1.6 VXR	1598	150	4	06.11-08.14	A16LES, Z16LER		EPBMFT5-V017H	90311	EPBMFT5-V001P	93006
1.7 CDTI	1686	92	4	11.06-08.14	Z17DTR		EPBMFT5-V006H	94366		
1.7 CDTI	1686	96	4	03.07-08.14	A17DTS		EPBMFT5-T011H	92630		

CORSA MK IV (E) (X15)

1.3 CDTi	1248	55	4	08.14-	B13DTC, B13DTN		EPBMFT5-T001D	94095		
1.3 CDTi	1248	70	4	08.14-	B13DTE, B13DTR		EPBMFT5-T001D	94095		
1.4	1398	55	4	09.14-	B14XEJ		EPBMFT5-T001D	94095		
1.4	1398	66	4	08.14-	B14XEL, D14XEL		EPBMFT5-T001D	94095		
1.6 VXR	1598	151	4	04.15-	B16LES		EPBMFT5-T001D	94095		



MAF



l kW
C
Y
I



Type-Nº

Stock-Nº

Plug In
Alternative
Type-Nº

Plug In
Subtype

VAUXHALL

FRONTERA MK II (B) (U99)

2.2 DTI	2171	85	4	10.98-09.04	X22DTH, Y22DTH	; Chass.>3V5000001	EPBMFT5-V019H	96039	EPBMFT5-V001P	93006
2.2 DTI	2171	85	4	10.98-09.04	X22DTH	; Chass.<2V599999	EPBMFT5-V008H	93715		
2.2 DTI	2171	85	4	10.98-09.04	Y22DTH	; Chass.<2V599999	EPBMFT5-V008H	93715		
2.2 DTI	2171	88	4	09.00-10.04	Y22DTH	; Chass.<2V599999	EPBMFT5-V008H	93715		

INSIGNIA MK I (A) (G09)

1.6	1598	85	4	07.08-07.12	A16XER		EPBMFT5-T011H	92630		
1.6 CDTI	1598	100	4	07.15-05.17	B16DTH		EPBMFT5-T003H	91493		
1.6 Turbo	1598	132	4	01.09-05.17	A16LET		EPBMFT5-T003H	91493		
1.8	1796	103	4	07.08-05.17	A18XER, B18XER		EPBMFT5-T011H	92630		
2.0 CDTI	1956	81	4	07.08-05.17	A20DTC, A20DTL		EPBMFT5-T003H	91493		
2.0 CDTI	1956	88	4	03.12-03.16	A20DTE		EPBMFT5-T003H	91493		
2.0 CDTI	1956	96	4	07.08-12.14	A20DT		EPBMFT5-T003H	91493		
2.0 CDTI	1956	96	4	07.08-12.14	A20DTJ, A20DT		EPBMFT5-T003H	91493		
2.0 CDTI	1956	103	4	07.13-05.17	A20DTE		EPBMFT5-T003H	91493		
2.0 CDTI	1956	118	4	07.08-05.17	A20DTH		EPBMFT5-T003H	91493		
2.0 CDTI 4x4	1956	118	4	07.08-05.17	A20DTH		EPBMFT5-T003H	91493		
2.0 CDTI	1956	120	4	07.13-05.17	A20DTH		EPBMFT5-T003H	91493		
2.0 CDTI	1956	125	4	11.14-05.17	B20DTH		EPBMFT5-T003H	91493		
2.0 CDTI 4x4	1956	125	4	11.14-05.17	B20DTH		EPBMFT5-T003H	91493		
2.0 CDTI	1956	140	4	10.08-05.17	A20DTR		EPBMFT5-T003H	91493		
2.0 CDTI 4x4	1956	140	4	05.09-05.17	A20DTR		EPBMFT5-T003H	91493		
2.0 Biturbo CDTI	1956	143	4	03.12-05.17	A20DTR		EPBMFT5-T003H	91493		
2.0 Biturbo CDTI 4x4	1956	143	4	03.12-05.17	A20DTR		EPBMFT5-T003H	91493		

MERIVA A (X03)

1.3 CDTI	1248	51	4	04.05-06.10	Z13DT, Y13DT		EPBMFT5-V022H	93863		
1.4 16V Twinport	1364	66	4	01.03-06.10	Z14XEP		EPBMFT5-V007H	97257	EPBMFT5-V001P	93006
1.6 Turbo	1598	132	4	05.06-06.10	Z16LET		EPBMFT5-V017H	90311		
1.6 Turbo	1598	132	4	05.06-06.10	Z16LET		EPBMFT5-V001P	93006		
1.7 DTI	1686	55	4	06.03-09.05	Y17DT		EPBMFT5-V001P	93006		
1.7 CDTi	1686	74	4	09.03-08.05	Z17DTH		EPBMFT5-V022H	93863		
1.8 i 16V	1796	92	4	05.03-06.10	Z18XE		EPBMWT4-V002H	92668		

MERIVA MK II (B) (S10)

1.3 CDTI	1248	55	4	06.10-	A13DTC		EPBMFT5-T011H	92630		
1.3 CDTi	1248	70	4	06.10-	A13DTE		EPBMFT5-T011H	92630		
1.4	1364	88	4	06.10-	A14NEL, B14NEL		EPBMFT5-T011H	92630		
1.4 LPG	1364	88	4	06.11-	A14NEL		EPBMFT5-T011H	92630		
1.4 LPG	1364	88	4	06.11-	B14NEL		EPBMFT5-T011H	92630		
1.4	1364	103	4	06.10-	A14NET, B14NET		EPBMFT5-T011H	92630		



MAF



l kW
C
Y
I



Type-N°

Stock-N°

Plug In
Alternative
Type-N°

Plug In
Subtype

VAUXHALL

MERIVA MK II (B) (S10)

1.4	1398	74	4	06.10-	A14XER, B14XER		EPBMFT5-T001D	94095		
1.6 CDTI	1598	70	4	01.14-	B16DTC		EPBMFT5-T001D	94095		
1.6 CDTi	1598	81	4	07.14-	B16DTE, B16DTL, B16DTN		EPBMFT5-T001D	94095		
1.6 CDTi	1598	100	4	08.13-	B16DTH		EPBMFT5-T001D	94095		
1.7 CDTI	1686	74	4	06.10-	A17DT		EPBMFT5-T011H	92630		
1.7 CDTi	1686	81	4	06.10-	A17DTC, A17DTI		EPBMFT5-T011H	92630		
1.7 CDTi	1686	81	4	06.10-	A17DTI		EPBMFT5-T011H	92630		
1.7 CDTi	1686	96	4	06.10-	A17DTS		EPBMFT5-T011H	92630		

MOVANO MK I (A) (X70)

1.9 DTI	1870	60	4	10.03-05.10	F9Q774		EPBMFT6-A044H	92490		
2.2 DTI	2188	66	4	09.00-05.10	G9T720, G9T722, G9T750		EPBMFT6-A044H	92490		
2.5 CDTI	2463	74	4	10.01-08.09	G9U650		EPBMWT6-A007H	93605		
2.5 DTI	2463	84	4	10.01-05.10	G9U720, G9U724, G9U750, G9U754		EPBMWT6-A007H	93605		
2.5 DTI	2463	84	4	10.01-05.10	G9U720		EPBMFT6-A044H	92490		
2.5 CDTI	2463	88	4	10.06-05.10	G9U632, G9U650		EPBMWT6-A007H	93605		
2.5 CDTI	2463	107	4	08.06-05.10	G9U650, G9U632		EPBMWT6-A007H	93605		
2.5 CDTI	2464	88	4	02.03-08.09	G9U632, G9U650		EPBMWT6-A007H	93605		
2.5 CDTI	2464	107	4	08.06-05.10	G9U632		EPBMWT6-A007H	93605		

OMEGA (B) (V94)

2.0 DTI 16V	1995	74	4	01.98-09.00	X20DTH		EPBMFT5-V017H	90311		
2.0 16V	1998	100	4	03.94-07.01	X20XEV		EPBMWN4-A019H	92343		
2.2 DTI 16V	2171	88	4	08.00-06.03	Y22DTH		EPBMFT5-V017H	90311	EPBMFT5-V001P	93006
2.2 16V	2198	106	4	10.99-06.03	Y22XE, Z22XE		EPBMWT4-V002H	92668		
2.5 TD	2497	96	6	04.94-07.01	X25DT		EPBMFN6-R030H	90274		
2.6 V6	2597	132	6	08.00-06.03	Y26SE		EPBMFT5-V008H	93715		
3.2 V6	3175	160	6	02.01-06.03	Y32SE		EPBMFT5-V008H	93715		

SIGNUM (Z03)

1.8	1796	90	4	06.03-07.05	Z18XE		EPBMWT4-V002H	92668		
1.8	1796	103	4	11.05-05.08	Z18XER		EPBMFT4-V048H	95493		
1.9 CDTI	1910	88	4	04.04-03.08	Z19DT		EPBMFN4-V026H	94497		
1.9 CDTI	1910	88	4	04.04-03.08	Z19DT		EPBMFN4-V010H	97588		
1.9 CDTI 16V	1910	110	4	04.04-03.08	Z19DTH		EPBMFN4-V026H	94497		
1.9 CDTI 16V	1910	110	4	04.04-03.08	Z19DTH		EPBMFN4-V010H	97588		
2.0 DTI	1994	74	4	05.03-04.04	Y20DTH		EPBMFT5-V019H	96039	EPBMFT5-V001P	93006
2.2 DTI	2172	92	4	05.03-12.04	Y22DTR		EPBMFT5-V019H	96039	EPBMFT5-V001P	93006
2.2 i	2198	114	4	05.03-05.08	Z22YH		EPBMWT5-V021H	97091		
3.0 V6 CDTI	2959	135	6	09.05-06.08	Z30DT		EPBMFT5-V001P	93006		
3.2 V6	3175	155	6	05.03-05.08	Z32SE		EPBMFT5-V035H	94119		



MAF



l kW
C
Y
I



Type-Nº

Stock-Nº

Plug In
Alternative
Type-Nº

Plug In
Subtype

VAUXHALL

SINTRA (APV)

2.2 DTI	2171	85	4	07.97-04.99	X22DTH		EPBMFT5-V008H	93715		
---------	------	----	---	-------------	--------	--	---------------	-------	--	--

TIGRA TWINTOP (X04)

1.3 CDTI	1248	51	4	06.04-08.09	Z13DT		EPBMFT5-V010H	96310	EPBMFT5-V001P	93006
1.4	1364	66	4	06.04-08.09	Z14XEP		EPBMFT5-V007H	97257	EPBMFT5-V001P	93006
1.8	1796	92	4	06.04-08.09	Z18XE		EPBMWT4-V002H	92668		

VECTRA (B) (J96)

1.6 i	1598	55	4	08.95-10.01	X16SZR		EPBMWN4-A019H	92343		
1.8 i 16V	1796	85	4	10.95-03.99	X18XE		EPBMWN4-A019H	92343		
1.8 i 16V	1796	85	4	03.99-09.00	X18XE1		EPBMWT4-V002H	92668		
1.8 i 16V	1796	92	4	09.00-03.02	Z18XE		EPBMWT4-V002H	92668		
1.8 i 16V	1799	85	4	10.95-03.99	X18XE		EPBMWN4-A019H	92343		
1.8 i 16V	1799	85	4	03.99-09.00	X18XE1		EPBMWT4-V002H	92668		
2.0 Di 16V	1995	60	4	08.95-10.01	X20DTL	; Chass.>W7000001; Chass.>XL000001	EPBMFT5-V017H	90311		
2.0 DTi 16V	1995	74	4	09.00-	Y20DTH		EPBMFT5-V017H	90311	EPBMFT5-V001P	93006
2.0 DTi 16V	1995	74	4	-09.00	X20DTH		EPBMFT5-V017H	90311		
2.0 i 16V	1998	100	4	10.95-01.01	X20XEV		EPBMWN4-A019H	92343		
2.2 DTi 16V	2172	92	4	09.00-	Y22DTR		EPBMFT5-V017H	90311	EPBMFT5-V001P	93006
2.2 i 16V	2198	108	4	09.00-07.03	Z22SE		EPBMWT5-V023H	95103		
2.6 i V6	2597	125	6	09.00-03.02	Y26SE		EPBMFT5-V008H	93715		

VECTRA MK II (C) (Z02)

1.8 16V	1796	90	4	04.02-07.08	Z18XE		EPBMWT4-V002H	92668		
1.8 16V Dualfuel	1796	90	4	04.02-07.08	Z18XE		EPBMWT4-V002H	92668		
1.8	1796	103	4	01.06-07.08	Z18XER		EPBMFT4-V048H	95493		
1.9 CDTI	1910	88	4	04.02-09.08	Z19DT		EPBMFN4-V026H	94497		
1.9 CDTI	1910	88	4	04.02-09.08	Z19DT		EPBMFN4-V010H	97588		
1.9 CDTI 16V	1910	110	4	04.04-05.09	Z19DTH		EPBMFN4-V026H	94497		
1.9 CDTI 16V	1910	110	4	04.04-05.09	Z19DTH		EPBMFN4-V010H	97588		
2.0 DTi 16V	1995	74	4	04.02-10.08	Y20DTH		EPBMFT5-V019H	96039	EPBMFT5-V001P	93006
2.2 DTi 16V	2172	92	4	04.02-09.04	Y22DTR		EPBMFT5-V019H	96039	EPBMFT5-V001P	93006
2.2 16V	2198	108	4	01.02-10.08	Z22SE		EPBMWN4-A019H	92343		
2.2 16V	2198	108	4	01.02-10.08	Z22SE		EPBMWT5-V023H	95103		
2.2 direct	2198	114	4	01.04-07.08	Z22YH		EPBMWT5-V021H	97091		
3.0 CDTi	2958	135	6	08.05-07.08	Z30DT		EPBMFT5-V001P	93006		

VIVARO A (X83)

1.9 DI	1870	59	4	04.03-07.14	F9Q762		EPBMWT6-A001H	90144		
1.9 DTI	1870	74	4	08.01-12.06	F9Q760		EPBMWT6-A001H	90144		
2.0 CDTI	1995	66	4	01.06-07.14	M9R630, M9R692		EPBMWT4-A019H	94808		
2.0 CDTI	1995	66	4	01.06-07.14	M9R782	; 6 pin connector	EPBMWT6-A007H	93605		
2.0 CDTI	1995	66	4	01.06-07.14	M9R786, M9R782, M9R780	; 6 pin connector	EPBMWT6-A007H	93605		



MAF



l kW
C
Y
I



Type-N°

Stock-N°

Plug In
Alternative
Type-N°

Plug In
Stock-N°

VAUXHALL

VIVARO A (X83)

2.0 CDTI	1995	84	4	08.06-07.14	M9R630, M9R692		EPBMWT4-A019H	94808		
2.0 CDTI	1995	84	4	08.06-07.14	M9R786, M9R788, M9R780, M9R784	; 6 pin connector	EPBMWT6-A007H	93605		
2.0 CDTI	1995	84	4	08.06-07.14	M9R788, M9R780	; 6 pin connector	EPBMWT6-A007H	93605		
2.5 CDTI	2464	99	4	04.03-07.06	G9U730		EPBMWT6-A007H	93605		
2.5 DTI	2464	99	4	07.03-07.14	G9U730		EPBMWT6-A007H	93605		
2.5 CDTI	2464	107	4	08.06-07.14	G9U630		EPBMWT6-A007H	93605		

VX220 CONVERTIBLE (E01)

2.0 i Turbo	1998	147	4	12.02-	Z20LET		EPBMFT5-V017H	90311		
2.0 VXR	1998	162	4	10.03-07.05	Z20LET		EPBMFT5-V017H	90311		
2.2 i	2198	108	4	09.00-07.05	Z22SE		EPBMWN4-A019H	92343		

ZAFIRA A (T98)

1.6 16V	1598	74	4	04.99-08.05	Z16XE		EPBMWT5-V010H	93933		
1.8 16V	1796	85	4	05.99-08.00	X18XE1		EPBMWT4-V002H	92668		
2.0 DI 16V	1995	60	4	10.99-08.05	X20DTL		EPBMFT5-V017H	90311		
2.0 DTI 16V	1995	74	4	04.99-08.05	Y20DTH	; Chass.<Y89999999; Chass.<YH9999999; Chass.<Y69999999; Chass.<Y29999999; Chass.<Y59999999	EPBMFT5-V017H	90311		
2.0 DTI 16V	1995	74	4	04.99-08.05	Y20DTH	; Chass.>18000001; Chass.>1H000001; Chass.>16000001; Chass.>12000001; Chass.>15000001; Chass.<289999999; Chass.<2H9999999; Chass.<269999999; Chass.<229999999; Chass.<259999999	EPBMFT5-V017H	90311	EPBMFT5-V001P	93006
2.0 DTI 16V	1995	74	4	01.00-08.05	Y20DTH	; Chass.>38000001; Chass.>3H000001; Chass.>36000001; Chass.>32000001; Chass.>35000001	EPBMFT5-V010H	96310		
2.0 GSI Turbo	1998	141	4	10.01-	Z20LET		EPBMFT5-V017H	90311		
2.0	1998	147	4	06.02-06.05	Z20LET		EPBMFT5-V017H	90311		
2.2 16V	2198	108	4	11.98-08.04	Z22SE		EPBMWN4-A019H	92343		

ZAFIRA MK II (B) (A05)

1.6	1598	77	4	07.05-11.14	Z16XE1, Z16XEP	; Chass.<6G9999999; Chass.<629999999	EPBMWT5-V010H	93933		
1.7 CDTI	1686	81	4	04.09-11.14	Z17DTJ, A17DTJ		EPBMFT5-V006H	94366		
1.7 CDTI	1686	92	4	01.08-11.14	A17DTR		EPBMFT5-V006H	94366		
1.8	1796	103	4	04.05-11.14	Z18XER		EPBMFT4-V048H	95493		
1.9 CDTI	1910	88	4	07.05-11.14	Z19DT		EPBMWN3-V009H	96875		
1.9 CDTI	1910	110	4	07.05-11.14	Z19DTH		EPBMWN3-V009H	96875		
2.0	1998	147	4	07.05-12.10	Z20LER		EPBMFT5-V001P	93006		
2.0	1998	176	4	01.06-11.14	Z20LEH		EPBMFT5-V020H	90244		
2.2	2198	110	4	07.05-11.14	Z22YH		EPBMWT5-V021H	97091		



MAF



l kW
C
Y
I



Type-Nº

Stock-Nº

Plug In
Alternative
Type-Nº

Plug In
Subtype

VAUXHALL

ZAFIRA MK III (P12)

1.4	1364	88	4	10.11-08.18	A14NEL		EPBMFT5-T001D	94095		
1.4	1364	103	4	10.11-08.18	A14NET, B14NET		EPBMFT5-T001D	94095		
1.6 CDTi	1598	99	4	10.16-08.18	B16DTH		EPBMFT5-T001D	94095		
1.6 CDTi	1598	100	4	03.13-08.18	B16DTH		EPBMFT5-T001D	94095		
1.6 CNG	1598	110	4	10.11-08.18	A16XNT		EPBMFT5-T001D	94095		
1.8	1796	85	4	10.11-08.18	A18XEL		EPBMFT5-T001D	94095		
1.8	1796	103	4	10.11-08.18	A18XER		EPBMFT5-T001D	94095		
2.0 CDTi	1956	81	4	10.11-08.18	A20DTL		EPBMFT5-T003H	91493		
2.0 CDTi	1956	96	4	10.11-08.18	A20DT, Z20DTJ, Y20DTJ		EPBMFT5-T003H	91493		
2.0 CDTi	1956	121	4	10.11-08.18	A20DTH		EPBMFT5-T003H	91493		
2.0 CDTi	1956	125	4	01.15-08.18	B20DTH		EPBMFT5-T001D	94095		
2.0 BiTurbo CDTi	1956	143	4	11.12-08.18	A20DTR		EPBMFT5-T003H	91493		
2.0	1998	147	4	-12.10	Z20LER		EPBMFT5-V017H	90311		

VOLVO

850 (854, 855)

2.0	1984	105	5	02.93-07.96	B5204F		EPBMFN5-D005H	92204		
2.4	2435	125	5	08.91-07.96	B5254S		EPBMFN5-D005H	92204		

C30 (533)

1.6 D	1560	80	4	10.06-12.07	D4164T		EPBMFT5-A001H	93740		
1.6 D	1560	80	4	10.06-12.12	D4164T		EPBMWT4-V002D	95695		
1.6 D2	1560	84	4	10.10-12.12	D4162T		EPBMWT4-V003D	94395		
1.6 D2	1560	84	4	10.10-12.12	D4162T		EPBMWT4-V002D	95695		
2.0 D	1997	100	4	10.06-12.07	D4204T		EPBMWT4-A008H	90627		
2.0 D	1997	100	4	10.06-12.12	D4204T		EPBMWT4-V002D	95695		
D5	2400	120	5	10.06-12.12	D5244T9		EPBMFN4-V007H	93735		
D5	2400	132	5	10.06-12.12	D5244T8, D5244T13		EPBMFN4-V007H	93735		
2.4 i	2435	125	5	10.06-12.12	B5244S4		EPBMWT5-A014D	90205		
T5	2521	162	5	10.06-12.12	B5254T3		EPBMFT5-V021H	95278		
T5	2521	169	5	03.07-12.12	B5254T7		EPBMFT5-V021H	95278		

C70 I (872, 873)

2.0 T	1984	120	5	03.00-09.02	B5204T4		EPBMFT5-V001P	93006		
2.0 T	1984	120	5	01.03-10.05	B5204T4		EPBMFT5-V021H	95278	EPBMFT5-V001P	93006
2.0 T	1984	166	5	01.03-10.05	B5204T3		EPBMFT5-V021H	95278	EPBMFT5-V001P	93006
2.3 T-5	2319	176	5	02.99-09.02	B5234T3		EPBMFT5-V021H	95278	EPBMFT5-V001P	93006
2.3 T5	2319	176	5	01.03-10.05	B5234T3		EPBMFT5-V021H	95278	EPBMFT5-V001P	93006
2.3 T5	2319	180	5	01.03-10.05	B5234T9		EPBMFT5-V021H	95278	EPBMFT5-V001P	93006
2.4 T	2435	142	5	04.98-09.02	B5254T		EPBMFT5-V021H	95278		
2.4 T	2435	147	5	01.03-10.05	B5244T7		EPBMFT5-V021H	95278	EPBMFT5-V001P	93006



MAF



l kW
C
Y
I



Type-N°

Stock-N°

Plug In
Alternative
Type-N°

Plug In
Alternative

VOLVO

C70 II CONVERTIBLE (542)

2.0 D	1997	100	4	01.08-10.09	D4204T		EPBMWT4-V002D	95695		
2.4 D	2400	120	5	03.07-06.13	D5244T9		EPBMFN4-V007H	93735		
D5	2400	132	5	03.06-06.13	D5244T8, D5244T13		EPBMFN4-V007H	93735		
2.4	2435	103	5	03.06-10.09	B5244S5		EPBMWT5-A014D	90205		
2.4 i	2435	125	5	03.06-10.09	B5244S4		EPBMWT5-A014D	90205		
T5	2521	162	5	03.06-02.07	B5254T3		EPBMFT5-V021H	95278		
T5	2521	169	5	03.07-10.09	B5254T7		EPBMFT5-V021H	95278		

S40 I (644)

1.6	1587	80	4	04.99-12.03	B4164S2		EPBMWT5-D020H	97934		
1.8	1783	85	4	06.01-08.03	B4184S2		EPBMWT5-D020H	97934		
1.8	1783	90	4	03.99-12.03	B4184S2		EPBMWT5-D020H	97934		
1.9 DI	1870	75	4	07.00-12.03	D4192T4		EPBMWT6-A001H	90144		
1.9 DI	1870	85	4	07.00-12.03	D4192T3		EPBMWT6-A001H	90144		
2.0	1948	100	4	04.99-12.03	B4204S2		EPBMWT5-D020H	97934		
2.0 T	1948	118	4	10.97-05.00	B4204T		EPBMWN3-A023H	91067		
2.0 T	1948	120	4	06.01-12.03	B4204T3		EPBMWN3-A023H	91067		
2.0 T	1948	121	4	07.00-06.01	B4204T3		EPBMWN3-A023H	91067		
2.0 T4	1948	147	4	07.00-12.03	B4204T5		EPBMWN3-A023H	91067		

S40 II (544)

1.6 D	1560	81	4	01.05-12.12	D4164T		EPBMFT5-A001H	93740		
1.6 D	1560	81	4	01.08-12.12	D4164T		EPBMWT4-V002D	95695		
1.6 D2	1560	84	4	10.10-12.12	D4162T		EPBMWT4-V003D	94395		
1.6 D2	1560	84	4	10.10-05.12	D4162T		EPBMWT4-V002D	95695		
2.0 D	1997	100	4	01.04-12.07	D4204T		EPBMWT4-A008H	90627		
2.4 CDI	2400	120	5	03.07-12.10	D5244T9		EPBMFN4-V007H	93735		
2.4 D5	2400	132	5	03.06-12.10	D5244T8, D5244T13		EPBMFN4-V007H	93735		
2.4	2435	103	5	01.04-12.10	B5244S5		EPBMWT5-A014D	90205		
2.4	2435	125	5	01.04-12.12	B5244S4		EPBMWT5-A014D	90205		
T5	2521	162	5	02.04-12.07	B5254T3		EPBMFT5-V021H	95278		
T5 AWD	2521	162	5	04.04-12.07	B5254T3		EPBMFT5-V021H	95278		
T5	2521	169	5	03.07-12.12	B5254T7		EPBMFT5-V021H	95278		
T5 AWD	2521	169	5	03.07-12.10	B5254T7		EPBMFT5-V021H	95278		

S60 I (384)

2.0 T	1984	132	5	07.00-04.10	B5204T5		EPBMFT5-V021H	95278	EPBMFT5-V001P	93006
T5	2319	184	5	07.00-07.01	B5234T3		EPBMFT5-V021H	95278	EPBMFT5-V001P	93006
2.3 T5	2319	195	5	07.00-09.02	B5234T7		EPBMFT5-V021H	95278		
2.4 D	2400	93	5	03.05-04.10	D5244T7, D5244T5		EPBMFN4-V007H	93735		
2.4 D	2400	120	5	07.05-12.09	D5244T5		EPBMFN4-V007H	93735		
2.4 CDI	2401	85	5	10.03-12.05	D5244T3		EPBMFT5-V021H	95278		
2.4 D	2401	90	5	05.05-12.06	D5244T6		EPBMFN4-V007H	93735		



MAF



l kW
C
Y
I



Type-Nº

Stock-Nº

Plug In
Alternative
Type-Nº

Plug In
Subtype

VOLVO

S60 I (384)

2.4 D	2401	96	5	05.01-04.10	D5244T2		EPBMFT5-V021H	95278		
2.4 D5	2401	120	5	01.01-04.10	D5244T		EPBMFT5-V021H	95278		
2.4 D5	2401	136	5	03.05-04.10	D5244T4		EPBMFN4-V007H	93735		
2.4 T5	2401	191	5	04.04-04.10	B5244T5		EPBMWT5-A014D	90205		
2.4 T5	2401	191	5	04.04-04.10	B5244T5		EPBMFN5-V032H	95044	EPBMFT5-V001P	93006
2.4	2435	103	5	07.00-04.10	B5244S2		EPBMWT5-A014D	90205		
2.4 Bifuel	2435	103	5	07.01-04.10	B5244SG2		EPBMWT5-A014D	90205		
2.4 Bifuel	2435	103	5	07.01-04.10	B5244SG		EPBMWT5-A014D	90205		
2.4	2435	125	5	11.00-04.10	B5244S		EPBMWT5-A014D	90205		
2.4	2435	132	5	01.05-10.06	B5244T4		EPBMWT5-A014D	90205		
2.4	2435	132	5	01.05-10.06	B5244T4		EPBMFN5-V032H	95044		
2.4 T	2435	147	5	07.00-12.01	B5244T3		EPBMFT5-V021H	95278	EPBMFT5-V001P	93006
2.4 T AWD	2435	147	5	06.01-12.01	B5244T3		EPBMFT5-V021H	95278	EPBMFT5-V001P	93006
2.5 T AWD	2521	154	5	07.02-04.10	B5254T2		EPBMFT5-V021H	95278	EPBMFT5-V001P	93006
2.5 T	2521	154	5	01.03-04.10	B5254T2		EPBMFT5-V021H	95278	EPBMFT5-V001P	93006
R 2.5 T AWD	2521	221	5	01.03-04.10	B5254T4		EPBMWT5-A014D	90205		
R 2.5 T AWD	2521	221	5	01.03-07.07	B5254T4		EPBMFN5-V032H	95044	EPBMFT5-V001P	93006

S60 II (134)

DRiVe / D2	1560	84	4	01.11-12.15	D4162T		EPBMWT4-V003D	94395		
T3	1596	110	4	04.10-12.15	B4164T3		EPBMWT4-V003D	94395		
T4	1596	132	4	04.10-12.15	B4164T		EPBMWT4-V003D	94395		
T4F	1596	132	4	04.11-12.15	B4164T2		EPBMWT4-V003D	94395		
2.0 T	1999	149	4	04.10-12.11	B4204T6		EPBMWT4-V003D	94395		
T5	1999	177	4	04.10-12.14	B4204T7		EPBMWT4-V003D	94395		

S70/V70 (874, 875, 876)

2.0	1984	120	5	01.97-11.00	B5204T4		EPBMFT5-V021H	95278		
2.0 Turbo	1984	155	5	12.95-03.00	B5204T		EPBMFT5-V021H	95278		
2.0 Turbo AWD	1984	166	5	11.96-12.00	B5204T3		EPBMFT5-V021H	95278		
2.0 Turbo	1984	166	5	01.97-11.00	B5204T3		EPBMFT5-V021H	95278		
2.3	2319	177	5	11.96-11.00	B5234T3		EPBMFT5-V021H	95278		
2.3 AWD	2319	177	5	04.97-09.98	B5234T3		EPBMFT5-V021H	95278		
2.3 AWD	2319	195	5	12.98-02.00	B5234T7, B5234T8		EPBMFT5-V021H	95278		
2.3	2319	195	5	04.99-09.00	B5234T7		EPBMFT5-V021H	95278		
2.4 Turbo	2435	142	5	01.97-11.00	B5244T, B5254T		EPBMFT5-V021H	95278		
2.4 Turbo AWD	2435	195	5	03.99-12.00	B5244T2		EPBMFT5-V021H	95278		
2.5 TDi AWD	2460	103	5	11.96-02.00	D5252T		EPBMFT5-V021H	95278		
2.5 TDI	2461	103	5	12.95-12.00	D5252T		EPBMFT5-V021H	95278		



MAF



l kW
C
Y
I



Type-N°

Stock-N°

Plug In
Alternative
Type-N°

Plug In
stock-N°

VOLVO

S80 I (184)

2.0	1984	120	5	06.98-07.06	B5204T4		EPBMFT5-V021H	95278		
2.0 T	1984	132	5	12.99-07.06	B5204T5		EPBMFT5-V021H	95278	EPBMFT5-V001P	93006
2.0 T	1984	166	5	06.98-07.06	B5204T3		EPBMFT5-V021H	95278		
2.3 R	2319	195	5	04.00-08.05	B5234T7		EPBMFT5-V021H	95278		
2.4 D	2401	96	5	10.01-07.06	D5244T2		EPBMFT5-V021H	95278		
2.4 D5	2401	120	5	08.01-07.06	D5244T		EPBMFT5-V021H	95278		
2.4	2435	103	5	01.01-07.06	B5244S2		EPBMWT5-A014D	90205		
2.4 Bifuel	2435	103	5	09.01-07.06	B5244SG2		EPBMWT5-A014D	90205		
2.4 Bifuel	2435	103	5	09.01-07.06	B5244SG		EPBMWT5-A014D	90205		
2.4	2435	125	5	01.01-07.06	B5244S		EPBMWT5-A014D	90205		
2.4 T	2435	147	5	06.00-07.06	B5244T3		EPBMFT5-V021H	95278	EPBMFT5-V001P	93006
2.4 T5 AWD	2435	147	5	04.00-09.03	B5244T3		EPBMFT5-V021H	95278	EPBMFT5-V001P	93006
2.5 TDI	2461	103	5	01.99-06.01	D5252T		EPBMFN4-V010H	97588		
2.5 T	2521	154	5	03.03-07.06	B5254T2		EPBMFT5-V021H	95278	EPBMFT5-V001P	93006
2.5 T AWD	2521	154	5	07.03-07.06	B5254T2		EPBMFT5-V021H	95278	EPBMFT5-V001P	93006
2.8 T6	2783	200	6	05.98-07.01	B6284T		EPBMFN5-V032H	95044	EPBMFT5-V001P	93006
3.0	2922	144	6	06.01-07.06	B6294S2		EPBMFT5-V021H	95278	EPBMFT5-V001P	93006
2.9	2922	147	6	03.99-07.06	B6294S		EPBMFT5-V021H	95278	EPBMFT5-V001P	93006
2.9	2922	150	6	05.98-07.06	B6304S3		EPBMFT5-V021H	95278	EPBMFT5-V001P	93006
3.0 T6	2922	200	6	12.01-07.06	B6294T		EPBMFN5-V032H	95044		

S80 II (124)

1.6 D DRIVe	1560	80	4	01.10-12.11	D4164T		EPBMWT4-V002D	95695		
1.6 DRIVe	1560	84	4	06.11-	D4162T		EPBMWT4-V003D	94395		
T4	1596	132	4	10.10-	B4164T		EPBMWT4-V003D	94395		
T4F	1596	132	4	05.11-	B4164T2		EPBMWT4-V003D	94395		
2.0 TDi	1997	100	4	02.08-03.11	D4204T		EPBMWT4-A001D	95860		
2.0 T	1999	149	4	01.10-	B4204T6		EPBMWT4-V003D	94395		
T5	1999	177	4	10.10-12.16	B4204T7		EPBMWT4-V003D	94395		
D5	2400	136	5	03.06-	D5244T4		EPBMFN4-V007H	93735		
D5 AWD	2400	136	5	01.07-	D5244T4		EPBMFN4-V007H	93735		
2.5 T	2521	147	5	03.06-12.11	B5254T6	; Chass.>165000; without suction pipe	EPBMFT5-V002D	97692		
2.5 T AWD	2521	147	5	10.06-04.09	B5254T6	; Chass.>165000; without suction pipe	EPBMFT5-V002D	97692		
2.5 T FlexFuel	2521	147	5	05.08-12.11	B5254T8	; Chass.>165000; without suction pipe	EPBMFT5-V002D	97692		
2.5 T	2521	170	5	01.10-12.12	B5254T10	; Chass.>165000; without suction pipe	EPBMFT5-V002D	97692		
2.5 T FlexFuel	2521	170	5	01.10-12.11	B5254T11	; Chass.>165000; without suction pipe	EPBMFT5-V002D	97692		



MAF



l kW
C
Y
I



Type-Nº

Stock-Nº

Plug In
Alternative
Type-Nº

Plug In
Subtype

VOLVO

S80 II (124)

3.2	3192	175	6	03.06-12.10	B6324S		EPBMWT5-A014D	90205		
3.2 AWD	3192	175	6	01.07-12.10	B6324S		EPBMWT5-A014D	90205		
3.2	3192	179	6	01.10-12.14	B6324S5		EPBMWT5-A014D	90205		
3.2 AWD	3192	179	6	01.10-12.12	B6324S5		EPBMWT5-A014D	90205		
4.4 V8 AWD	4414	232	8	03.06-03.12	B8444S		EPBMWT5-A014D	90205		

V40 ESTATE (645)

1.6	1587	80	4	04.99-06.04	B4164S2		EPBMWT5-D020H	97934		
1.6	1588	77	4	12.95-08.99	B4164S		EPBMWT5-D020H	97934		
1.8	1783	90	4	03.99-06.04	B4184S2		EPBMWT5-D020H	97934		
1.9 DI	1870	75	4	07.00-06.04	D4192T4		EPBMWT6-A001H	90144		
1.9 DI	1870	85	4	07.00-06.04	D4192T3		EPBMWT6-A001H	90144		
2.0 T	1948	118	4	10.97-05.00	B4204T		EPBMWN3-A023H	91067		
2.0 T	1948	120	4	06.01-06.04	B4204T3		EPBMWN3-A023H	91067		
2.0 T	1948	121	4	07.99-06.04	B4204T2	Chass.>600000; Chass.<999999	EPBMWN3-A023H	91067		
2.0 T4	1948	147	4	07.00-03.03	B4204T5		EPBMWN3-A023H	91067		

V40 HATCHBACK (525, 526)

D2	1560	84	4	03.12-	D4162T		EPBMWT4-V002D	95695		
T2 GTDi	1596	88	4	03.13-12.15	B4164T4		EPBMWT4-V002D	95695		
T3 GTDi	1596	110	4	03.12-	B4164T3		EPBMWT4-V003D	94395		
T3 GTDi	1596	110	4	03.12-	B4164T3		EPBMWT4-V002D	95695		
T4 GTDi	1596	132	4	03.12-	B4164T		EPBMWT4-V002D	95695		
T4	1984	132	5	07.13-12.15	B5204T8	; Without suction pipe	EPBMFT5-V002D	97692		
T4 AWD	1984	132	5	07.13-	B5204T8	; Without suction pipe	EPBMFT5-V002D	97692		
T5	1984	157	5	03.13-12.15	B5204T9	; Without suction pipe	EPBMFT5-V002D	97692		
T5 AWD	1984	157	5	03.13-	B5204T9	; Without suction pipe	EPBMFT5-V002D	97692		
T5	2497	187	5	12.12-	B5254T12	; Without suction pipe	EPBMFT5-V002D	97692		
T5 AWD	2497	187	5	01.13-	B5254T12	; Without suction pipe	EPBMFT5-V002D	97692		

V50 (545)

1.6 D	1560	81	4	01.05-12.07	D4164T		EPBMFT5-A001H	93740		
1.6 D	1560	81	4	01.08-12.11	D4164T		EPBMWT4-V002D	95695		
1.6 D2	1560	84	4	01.10-12.12	D4162T		EPBMWT4-V003D	94395		
1.6 D2	1560	84	4	01.10-05.12	D4162T		EPBMWT4-V002D	95695		
2.0 CDI	1997	98	4	12.03-12.06	D4204T2		EPBMWT4-V002D	95695		
2.0 D	1997	100	4	04.04-12.07	D4204T		EPBMWT4-A008H	90627		
2.4 Tdi	2400	120	5	05.07-12.10	D5244T9		EPBMFN4-V007H	93735		
2.4 D5	2400	132	5	03.06-12.10	D5244T8, D5244T13		EPBMFN4-V007H	93735		
2.4	2435	103	5	04.04-12.10	B5244S5		EPBMWT5-A014D	90205		
2.4	2435	125	5	04.04-12.10	B5244S4		EPBMWT5-A014D	90205		
2.4 AWD	2435	125	5	08.06-12.09	B5244S4		EPBMWT5-A014D	90205		



MAF



l kW
C
Y
I



Type-N°

Stock-N°

Plug In
Alternative
Type-N°

Plug In
Alternative

VOLVO

V50 (545)

T5	2521	162	5	04.04-12.07	B5254T3		EPBMFT5-V021H	95278		
T5 AWD	2521	162	5	04.04-12.07	B5254T3		EPBMFT5-V021H	95278		
T5	2521	169	5	03.07-12.12	B5254T7		EPBMFT5-V021H	95278		
T5 AWD	2521	169	5	03.07-12.10	B5254T7		EPBMFT5-V021H	95278		

V60 I (155, 157)

1.6 DRIVe	1560	84	4	02.11-12.15	D4162T		EPBMWT4-V003D	94395		
T3	1596	110	4	09.10-12.15	B4164T3		EPBMWT4-V003D	94395		
T4	1596	132	4	09.10-12.15	B4164T		EPBMWT4-V003D	94395		
T4F	1596	132	4	04.11-12.15	B4164T2		EPBMWT4-V003D	94395		
2.0 T	1999	149	4	07.10-12.12	B4204T6		EPBMWT4-V003D	94395		
T5	1999	176	4	08.12-	B4204T7		EPBMWT4-V003D	94395		
T5	1999	177	4	09.10-12.14	B4204T7		EPBMWT4-V003D	94395		

V70 II (285)

2.0 T	1984	132	5	11.99-08.07	B5204T5		EPBMFT5-V021H	95278	EPBMFT5-V001P	93006
2.3 T5	2319	184	5	11.99-12.04	B5234T3		EPBMWT5-A014D	90205		
2.3 T5	2319	184	5	07.01-12.04	B5234T3		EPBMFT5-V021H	95278	EPBMFT5-V001P	93006
2.3	2319	195	5	10.00-09.04	B5234T7		EPBMWT5-A014D	90205		
2.3	2319	195	5	10.00-09.04	B5234T7		EPBMFT5-V021H	95278		
2.4 D	2400	93	5	04.05-12.08	D5244T7		EPBMFN4-V007H	93735		
2.4 D5	2400	120	5	08.05-07.07	D5244T5		EPBMFN4-V007H	93735		
2.4 CDI	2401	90	5	07.05-12.08	D5244T6		EPBMFN4-V007H	93735		
2.4 D	2401	96	5	07.01-08.07	D5244T2		EPBMFT5-V021H	95278		
2.4 D5	2401	120	5	01.01-12.08	D5244T5		EPBMFN4-V007H	93735		
2.4 D5	2401	120	5	01.01-07.06	D5244T		EPBMFT5-V021H	95278		
2.4 D5 AWD	2401	120	5	07.02-07.06	5244T2, D5244T		EPBMFT5-V021H	95278		
2.4 D5 AWD	2401	120	5	07.02-08.07	D5244T5		EPBMFN4-V007H	93735		
2.4 D5	2401	136	5	04.05-12.08	D5244T4		EPBMFN4-V007H	93735		
2.4 D5 AWD	2401	136	5	05.05-08.07	D5244T4		EPBMFN4-V007H	93735		
2.4 T5	2401	191	5	04.04-08.07	B5244T5		EPBMFN5-V032H	95044	EPBMFT5-V001P	93006
2.4	2435	103	5	03.00-08.07	B5244S2		EPBMWT5-A014D	90205		
2.4 Bifuel	2435	103	5	09.01-08.07	B5244SG2		EPBMWT5-A014D	90205		
2.4	2435	125	5	03.00-08.07	B5244S		EPBMWT5-A014D	90205		
2.4 T	2435	147	5	07.01-08.03	B5244T3		EPBMFT5-V021H	95278	EPBMFT5-V001P	93006
2.4 T AWD	2435	147	5	09.01-08.02	B5244T3		EPBMFT5-V021H	95278	EPBMFT5-V001P	93006
2.5 T	2521	154	5	07.01-08.07	B5254T2		EPBMFT5-V021H	95278	EPBMFT5-V001P	93006
2.5 T AWD	2521	154	5	07.02-08.07	B5254T2		EPBMFT5-V021H	95278		
2.5 AWD	2521	155	5	09.02-12.04	B5254T2		EPBMFT5-V021H	95278		
R 2.5 T AWD	2521	221	5	03.03-08.07	B5254T4		EPBMFN5-V032H	95044	EPBMFT5-V001P	93006



MAF



l kW
C
Y
I



Type-Nº

Stock-Nº

Plug In
Alternative
Type-Nº

Plug In
Stock-Nº

VOLVO

V70 III (135)

1.6 D	1560	80	4	07.09-12.11	D4164T		EPBMWT4-V002D	95695		
1.6 DRIVe / D2	1560	84	4	04.11-12.15	D4162T		EPBMWT4-V003D	94395		
T4	1596	132	4	10.10-12.15	B4164T		EPBMWT4-V003D	94395		
1.6 T4F	1596	132	4	01.11-12.15	B4164T2		EPBMWT4-V003D	94395		
2.0 BiFuel	1984	157	5	03.13-12.15	B5204T9	; Chass.>165000; without suction pipe	EPBMFT5-V002D	97692		
2.0 D	1997	100	4	10.07-12.15	D4204T		EPBMWT4-A001D	95860		
2.0 T	1999	149	4	09.09-12.11	B4204T6		EPBMWT4-V003D	94395		
T5	1999	177	4	01.10-12.14	B4204T7		EPBMWT4-V003D	94395		
2.4 D	2400	120	5	04.07-12.10	D5244T5		EPBMFN4-V007H	93735		
D5	2400	136	5	04.07-12.09	D5244T4		EPBMFN4-V007H	93735		
D5 AWD	2401	136	5	04.07-12.09	D5244T4		EPBMFN4-V007H	93735		
2.5 T	2521	147	5	08.07-12.09	B5254T6	; Chass.>165000; without suction pipe	EPBMFT5-V002D	97692		
2.5 T FlexiFuel	2521	147	5	05.08-12.09	B5254T8	; Chass.>165000; without suction pipe	EPBMFT5-V002D	97692		
2.5 T	2521	170	5	04.09-12.12	B5254T10	; Chass.>165000; without suction pipe	EPBMFT5-V002D	97692		
2.5 T FlexiFuel	2521	170	5	04.09-12.11	B5254T11	; Chass.>165000; without suction pipe	EPBMFT5-V002D	97692		
3.2	3192	175	6	08.07-12.10	B6324S		EPBMWT5-A014D	90205		
3.2 AWD	3192	175	6	04.07-12.10	B6324S		EPBMWT5-A014D	90205		
3.2	3192	179	6	04.10-12.14	B6324S5		EPBMWT5-A014D	90205		
3.2 AWD	3192	179	6	04.10-12.15	B6324S5		EPBMWT5-A014D	90205		

XC60 I SUV (156)

T5	1999	177	4	09.10-02.17	B4204T7		EPBMWT4-V003D	94395		
2.4 D / D3 / D4 AWD	2400	120	5	05.08-02.17	D5244T5		EPBMFN4-V007H	93735		
D5 AWD	2400	136	5	05.08-12.09	D5244T4		EPBMFN4-V007H	93735		
3.2 AWD	3192	175	6	07.09-12.10	B6324S		EPBMWT5-A014D	90205		
3.2 AWD	3192	179	6	03.10-12.15	B6324S5		EPBMWT5-A014D	90205		

XC70 CROSS COUNTRY I (295) | V70 XC

2.4 D5 AWD	2401	136	5	12.05-08.07	D5244T4	Chass.>208044; 6Speed	EPBMFN4-V007H	93735		
2.4 D5 AWD	2401	136	5	12.05-08.07	D5244T4	Chass.>220845; 6Speed	EPBMFN4-V007H	93735		
2.4 T XC AWD	2435	142	5	11.97-09.02	B5254T		EPBMFT5-V021H	95278		
2.4 T XC AWD	2435	147	5	03.00-09.02	B5244T3		EPBMFT5-V021H	95278		
2.5 T XC AWD	2521	154	5	09.02-08.07	B5254T2		EPBMFT5-V021H	95278	EPBMFT5-V001P	93006

XC70 II (136)

2.4 D / D4 AWD	2400	120	5	08.07-	D5244T5		EPBMFN4-V007H	93735		
D5 AWD	2400	136	5	04.07-12.09	D5244T4		EPBMFN4-V007H	93735		
3.2 AWD	3192	175	6	08.07-12.11	B6324S		EPBMWT5-A014D	90205		
3.2 AWD	3192	179	6	05.10-12.14	B6324S5		EPBMWT5-A014D	90205		



MAF



l kW
C
Y
I



Type-N°

Stock-N°

Plug In
Alternative
Type-N°

Plug In
Alternative
Type-N°

VOLVO

XC90 I (275)

D5 AWD	2400	120	5	10.07-12.10	D5244T5		EPBMFN4-V007H	93735		
D3 / D5	2400	120	5	04.09-12.14	D5244T5		EPBMFN4-V007H	93735		
D5 AWD	2400	147	5	01.11-12.14	D5244T18		EPBMFN4-V007H	93735		
D5 AWD	2400	155	5	11.13-09.14	D5244T18		EPBMFN4-V007H	93735		
D5 AWD	2401	120	5	10.02-12.06	D5244T5	Chass.>574467	EPBMFN4-V007H	93735		
D5 AWD	2401	120	5	10.02-12.06	D5244T		EPBMFT5-V021H	95278		
D5 AWD	2401	136	5	04.05-12.10	D5244T4		EPBMFN4-V007H	93735		
2.5 T AWD	2497	154	5	10.12-09.14	B5254T9		EPBMFT5-V021H	95278		
2.5 AWD	2521	153	5	06.02-12.14	B5254T2		EPBMFT5-V021H	95278		
2.5 T AWD	2521	154	5	10.02-09.14	B5254T2		EPBMFT5-V021H	95278		
T6 AWD	2922	200	6	10.02-07.06	B6294T		EPBMFN5-V032H	95044	EPBMFT5-V001P	93006
3.2 AWD	3192	175	6	03.06-12.10	B6324S		EPBMWT5-A014D	90205		
3.2 AWD	3192	179	6	04.10-09.14	B6324S5		EPBMWT5-A014D	90205		
V8 AWD	4414	232	8	01.05-12.10	B8444S		EPBMWT5-A014D	90205		

VW

AMAROK (2HA, 2HB, S1B, S6B, S7A, S7B)

2.0 TDI	1968	90	4	09.10-10.13	CDBA, CNFA		EPBMFN4-V008H	95035		
2.0 TDI 4motion	1968	90	4	09.10-10.13	CDBA, CNFA		EPBMFN4-V008H	95035		
2.0 TDI	1968	103	4	07.12-10.16	CNFB		EPBMFN4-V008H	95035		
2.0 TDI 4motion	1968	103	4	06.12-10.16	CNFB		EPBMFN4-V008H	95035		
2.0 BiTDI	1968	120	4	09.10-10.16	CDCA		EPBMFN4-V008H	95035		
2.0 BiTDI 4motion	1968	120	4	09.10-10.16	CDCA		EPBMFN4-V008H	95035		
2.0 BiTDI	1968	132	4	11.11-	CNEA, CSHA		EPBMFN4-V008H	95035		
2.0 BiTDI 4motion	1968	132	4	11.11-	CNEA, CSHA		EPBMFN4-V008H	95035		
2.0 TDI	1968	132	4	09.11-10.16	CNEA, CSHA		EPBMFN4-V008H	95035		
2.0 TDI 4motion	1968	132	4	09.11-10.16	CNEA, CSHA		EPBMFN4-V008H	95035		
2.0 TSI	1984	118	4	12.10-10.16	CFPA		EPBMFN4-V008H	95035		
2.0 TSI	1984	118	4	12.10-10.16	CFPA		EPBMWT5-A027H	96756		

ARTEON (3H7, 3H8)

2.0 TDI	1968	110	4	04.17-	DFGA, DBGA		EPBMFN4-V008H	95035		
2.0 TDI	1968	140	4	05.17-	DFHA		EPBMFN4-V008H	95035		
2.0 TDI 4motion	1968	140	4	05.17-	DFHA		EPBMFN4-V008H	95035		

BEETLE (5C1, 5C2, 5C7, 5C8)

2.0 TDI	1968	81	4	06.14-09.18	CUUA		EPBMFN4-V008H	95035		
2.0 TDI	1968	103	4	04.11-07.16	CFFB		EPBMFN4-V008H	95035		
2.0 TDI	1968	103	4	04.11-07.16	CJAA		EPBMFN5-D001H	95207		
2.0 TDI	1968	110	4	07.14-09.18	CUUB, CVCA, DELA		EPBMFN4-V008H	95035		
2.0 TSI	1984	147	4	04.11-07.16	CBFA, CCTA, CCZA		EPBMWT5-A027H	96756		

BORA (1J6,1J2)

1.6	1595	74	4	10.98-05.05	AEH, AKL, APF		EPBMWT4-D014H	93236		
1.6	1595	74	4	05.99-05.05	AKL, AEH, APF		EPBMWT4-D014H	93236		
1.6	1595	75	4	08.00-05.05	AVU, BFQ		EPBMWT4-D014H	93236		



MAF



l kW
C
Y
I



Type-N°

Stock-N°

Plug In
Alternative
Type-N°

Plug In
Stock-N°

VW

BORA (1J6,1J2)

1.6 FSI	1598	81	4	01.02-05.05	BAD		EPBMFT5-D005P	90557		
1.8	1781	92	4	10.98-01.01	AGN		EPBMFT5-D005P	90557		
1.8 T	1781	110	4	05.00-05.05	AGU, ARX, AUM, BAE		EPBMW4-D014H	93236	EPBMFN5-D002P	91609
1.8 T	1781	110	4	05.00-05.05	AGU, ARX, AUM		EPBMFN5-D012H	96277		
1.8 T	1781	110	4	05.00-05.05	AUM		EPBMFN5-D012H	96277	EPBMFN5-D002P	91609
1.8 T	1781	132	4	03.02-05.05	AUQ, AWP		EPBMFN5-D012H	96277	EPBMFN5-D002P	91609
1.8 T	1781	132	4	05.02-05.05	AUQ		EPBMFN5-D012H	96277		
1.9 TDI	1896	66	4	10.98-05.05	AGR		EPBMFN5-D005H	92204	EPBMFN5-D002P	91609
1.9 TDI	1896	66	4	10.98-05.05	ALH	Chass.<1J4300000	EPBMFN5-D005H	92204	EPBMFN5-D002P	91609
1.9 TDI	1896	66	4	10.98-05.05	ALH	Chass.>1J5000001	EPBMFN5-D003H	95299	EPBMFN5-D002P	91609
1.9 TDI 4motion	1896	66	4	11.98-04.02	AGR		EPBMFN5-D005H	92204	EPBMFN5-D002P	91609
1.9 TDI	1896	66	4	07.04-05.05	AGR, ALH		EPBMFN5-D003H	95299	EPBMFN5-D002P	91609
1.9 TDI	1896	74	4	09.00-05.05	ATD, AXR		EPBMFN5-D003H	95299	EPBMFN5-D002P	91609
1.9 TDI	1896	74	4	09.00-05.05	ATD	Chass.<1J4300000	EPBMFN5-D005H	92204	EPBMFN5-D002P	91609
1.9 TDI	1896	74	4	09.00-05.05	ATD	Chass.>1J5000001	EPBMFN5-D003H	95299	EPBMFN5-D002P	91609
1.9 TDI	1896	74	4	09.00-05.05	AXR		EPBMFN5-D003H	95299	EPBMFN5-D002P	91609
1.9 TDI 4motion	1896	74	4	09.00-05.05	ATD		EPBMFN5-D003H	95299	EPBMFN5-D002P	91609
1.9 TDI	1896	81	4	05.99-06.01	AHF, ASV		EPBMFN5-D003H	95299	EPBMFN5-D002P	91609
1.9 TDI	1896	85	4	12.98-01.02	AJM, AUJ		EPBMFN5-D005H	92204	EPBMFN5-D002P	91609
1.9 TDI	1896	85	4	05.99-06.01	AJM, AUJ		EPBMFN5-D003H	95299	EPBMFN5-D002P	91609
1.9 TDI 4motion	1896	85	4	02.99-06.01	AJM, AUJ		EPBMFN5-D003H	95299	EPBMFN5-D002P	91609
1.9 TDI	1896	96	4	11.00-04.02	ASZ	Chass.<1J2600000	EPBMFN5-D013H	96315	EPBMFN5-D002P	91609
1.9 TDI 4motion	1896	96	4	11.00-04.02	ASZ	Chass.<1J2600000	EPBMFN5-D013H	96315	EPBMFN5-D002P	91609
1.9 TDI	1896	96	4	05.02-05.05	ASZ	Chass.>1J2600001	EPBMFN5-D002H	91692	EPBMFN5-D002P	91609
1.9 TDI 4motion	1896	96	4	05.02-05.05	ASZ	Chass.>1J2600001	EPBMFN5-D002H	91692	EPBMFN5-D002P	91609
1.9 TDI	1896	110	4	05.00-04.02	ARL	Chass.<1J2600000	EPBMFN5-D013H	96315	EPBMFN5-D002P	91609
1.9 TDI 4motion	1896	110	4	05.00-04.02	ARL	Chass.<1J2600000	EPBMFN5-D013H	96315	EPBMFN5-D002P	91609
1.9 TDI	1896	110	4	05.01-05.05	ARL		EPBMFN5-D002H	91692		
1.9 TDI 4motion	1896	110	4	05.01-05.05	ARL		EPBMFN5-D002H	91692		
1.9 TDI	1896	110	4	05.02-05.05	ARL	Chass.>1J2600001	EPBMFN5-D002H	91692	EPBMFN5-D002P	91609
1.9 TDI 4motion	1896	110	4	05.02-05.05	ARL	Chass.>1J2600001	EPBMFN5-D002H	91692	EPBMFN5-D002P	91609
2.0	1984	85	4	10.98-12.13	AQY, APK, AZJ, AZH		EPBMFT5-D005P	90557		
2.3 V5	2324	110	5	10.98-10.00	AGZ		EPBMFN5-D013H	96315	EPBMFN5-D002P	91609
2.3 V5 4motion	2324	110	5	05.00-10.00	AGZ		EPBMFN5-D013H	96315	EPBMFN5-D002P	91609
2.3 V5	2324	125	5	10.00-05.05	AQN		EPBMFT5-D024H	93373		
2.3 V5	2324	125	5	10.00-05.05	AQN		EPBMFN5-D013H	96315		
2.3 V5 4motion	2324	125	5	10.00-05.05	AQN		EPBMFT5-D024H	93373		
2.3 V5 4motion	2324	125	5	10.00-05.05	AQN		EPBMFN5-D013H	96315		
2.8 V6 4motion	2792	150	6	05.99-05.05	AQP, AUE, BDE		EPBMFT5-D024H	93373		
2.8 V6 4motion	2792	150	6	05.99-05.00	AQP, AUE, BDE		EPBMFN5-D013H	96315		
2.8 V6 4motion	2792	150	6	05.00-04.01	AUE		EPBMFN5-D013H	96315		
2.8 V6 4motion	2792	150	6	05.01-06.04	BDE		EPBMFN5-D013H	96315		

CADDY ALLTRACK (SAB, SAA)

2.0 TDI	1968	55	4	05.15-	CUUF, DFSF		EPBMFN4-V008H	95035		
---------	------	----	---	--------	------------	--	---------------	-------	--	--



MAF



l kW
C
Y
I



Type-Nº

Stock-Nº

Plug In
Alternative
Type-Nº

Plug In
stock-Nº

VW

CADDY ALLTRACK (SAB, SAA)

2.0 TDI	1968	75	4	05.15-	CUUD, DFSD		EPBMFN4-V008H	95035		
2.0 TDI 4motion	1968	90	4	05.15-	CUUE, DFSE		EPBMFN4-V008H	95035		
2.0 TDI	1968	110	4	05.15-	CUUB, DFSB		EPBMFN4-V008H	95035		
2.0 TDI 4motion	1968	110	4	11.15-	DFSB		EPBMFN4-V008H	95035		

CADDY II BOX BODY/MPV (9K9A, 9K9B)

1.9 TDI	1896	66	4	09.96-01.04	ALH		EPBMFN5-D015H	90376	EPBMFN5-D002P	91609
---------	------	----	---	-------------	-----	--	---------------	-------	---------------	-------

CADDY III (2KA, 2KH, 2CA, 2CH, 2KB, 2KJ, 2CB, 2CJ)

1.6 TDI	1598	55	4	08.10-05.15	CAYE		EPBMWT3-D024H	91171		
1.6 TDI	1598	75	4	08.10-05.15	CAYD		EPBMWT3-D024H	91171		
1.9 TDI	1896	55	4	09.05-08.10	BSU		EPBMFN5-D003H	95299		
1.9 TDI	1896	77	4	04.04-08.10	BJB, BLS		EPBMFN5-D003H	95299	EPBMFN5-D002P	91609
1.9 TDI 4motion	1896	77	4	05.08-08.10	BLS		EPBMFN5-D003H	95299		
2.0 SDI	1968	51	4	03.04-08.10	BST		EPBMFN5-D003H	95299	EPBMFN5-D002P	91609
2.0 TDI	1968	62	4	11.10-05.15	CFHE		EPBMFN4-V008H	95035		
2.0 TDI 4motion	1968	62	4	12.10-05.15	CFHE		EPBMFN4-V008H	95035		
2.0 TDI	1968	81	4	08.10-05.15	CLCA		EPBMFN4-V008H	95035		
2.0 TDI 4motion	1968	81	4	08.10-05.15	CFHF		EPBMFN4-V008H	95035		
2.0 TDI	1968	103	4	09.07-08.10	BMM		EPBMFN5-D002H	91692		
2.0 TDI 16V	1968	103	4	11.10-05.15	CFHC, CLCB		EPBMFN4-V008H	95035		
2.0 TDI 16V 4motion	1968	103	4	11.10-05.15	CFHC		EPBMFN4-V008H	95035		
2.0 TDI	1968	125	4	05.12-05.15	CFJA		EPBMFN4-V008H	95035		

CADDY IV (SAB, SAJ, SAA, SAH)

2.0 TDI	1968	55	4	05.15-	CUUF, DFSC, DFSF		EPBMFN4-V008H	95035		
2.0 TDI	1968	55	4	05.15-	CUUF, DFSF		EPBMFN4-V008H	95035		
2.0 TDI 4motion	1968	55	4	11.15-	DFSC		EPBMFN4-V008H	95035		
2.0 TDI	1968	75	4	05.15-	CUUD, DFSD		EPBMFN4-V008H	95035		
2.0 TDI 4motion	1968	81	4	05.15-05.16	CFHF		EPBMFN4-V008H	95035		
2.0 TDI 4motion	1968	90	4	05.15-	CUUE, DFSE		EPBMFN4-V008H	95035		
2.0 TDI	1968	103	4	05.15-	CFHC, CLOB		EPBMFN4-V008H	95035		
2.0 TDI 4motion	1968	103	4	05.15-	CFHC		EPBMFN4-V008H	95035		
2.0 TDI	1968	110	4	05.15-	CUUB, DFSB		EPBMFN4-V008H	95035		
2.0 TDI 4motion	1968	110	4	11.15-	DFSB		EPBMFN4-V008H	95035		

CC B7 (358)

1.8 TSI	1798	118	4	11.11-12.16	CDAА		EPBMWT5-A027H	96756		
2.0 TDI	1968	100	4	11.11-12.16	CFFA		EPBMFN4-V008H	95035		
2.0 TDI	1968	103	4	11.11-12.16	CFFB		EPBMFN4-V008H	95035		
2.0 TDI 4motion	1968	103	4	11.11-12.16	CFFB		EPBMFN4-V008H	95035		
2.0 TDI	1968	110	4	05.15-12.16	CUVC		EPBMFN4-V008H	95035		
2.0 TDI	1968	125	4	11.11-12.16	CFGB, CLLA		EPBMFN4-V008H	95035		
2.0 TDI 4motion	1968	125	4	11.11-01.13	CFGB		EPBMFN4-V008H	95035		
2.0 TDI	1968	130	4	12.12-12.16	CFGC		EPBMFN4-V008H	95035		
2.0 TDI 4motion	1968	130	4	12.12-12.16	CFGC		EPBMFN4-V008H	95035		
2.0 TDI	1968	135	4	05.15-12.16	CUWA		EPBMFN4-V008H	95035		
2.0 TSI	1984	155	4	11.11-12.16	CCZB		EPBMWT5-A027H	96756		
3.6 FSI 4motion	3597	220	6	11.11-12.16	BWS		EPBMFT5-D040H	97032		



MAF



l kW
C
y
I



Type-Nº

Stock-Nº

Plug In
Alternative
Type-Nº

Plug In
Subtype

VW

CRAFTER (SY_, SX_, SYI, SYJ, SZ_)

2.0 TDI	1968	75	4	10.16-	DAUB		EPBMFN4-V008H	95035		
2.0 TDI RWD	1968	80	4	05.17-	DASC		EPBMFN4-V008H	95035		
2.0 TDI RWD	1968	90	4	08.17-	DASA		EPBMFN4-V008H	95035		
2.0 TDI	1968	103	4	09.16-	DAUA		EPBMFN4-V008H	95035		
2.0 TDI 4motion	1968	103	4	04.17-	DAUA		EPBMFN4-V008H	95035		
2.0 TDI RWD	1968	103	4	10.17-	DASB		EPBMFN4-V008H	95035		
2.0 TDI RWD	1968	130	4	05.17-	DAWA		EPBMFN4-V008H	95035		

CRAFTER 30-35 (2E_, 2F)

2.0 TDI	1968	80	4	05.11-12.16	CKTB, CSLA		EPBMFN4-V008H	95035		
2.0 TDI	1968	80	4	05.11-12.16	CKTB		EPBMFN4-V008H	95035		
2.0 TDI	1968	84	4	11.13-12.16	CSLB		EPBMFN4-V008H	95035		
2.0 TDI	1968	100	4	05.11-12.16	CKTC		EPBMFN4-V008H	95035		
2.0 TDI	1968	103	4	11.15-12.16	CSLC		EPBMFN4-V008H	95035		
2.0 TDI	1968	105	4	10.11-12.16	CKUC		EPBMFN4-V008H	95035		
2.0 TDI	1968	120	4	07.11-12.16	CKUB, CSNA		EPBMFN4-V008H	95035		
2.0 TDI 4motion	1968	120	4	11.11-12.16	CKUB, CSNA		EPBMFN4-V008H	95035		

CRAFTER 30-35 (2E_, 2F_)

2.5 TDI	2461	65	5	04.06-07.11	BJJ, CEBA		EPBMFN4-D014H	92888		
2.5 TDI	2461	80	5	04.06-05.13	BJK, CEBB		EPBMFN4-D014H	92888		
2.5 TDI	2461	100	5	04.06-05.13	BJL, CECA		EPBMFN4-D014H	92888		
2.5 TDI	2461	120	5	04.06-07.11	BJM, CECB		EPBMFN4-D014H	92888		

EOS (1F7, 1F8)

2.0 TDI	1968	100	4	11.10-08.15	CFFA		EPBMFN4-V008H	95035		
2.0 TDI	1968	103	4	06.06-05.08	BMM		EPBMFN5-D002H	91692	EPBMFN5-D002P	91609
2.0 TDI 16V	1968	103	4	05.08-08.15	CBAB, CFFB		EPBMFN5-D001H	95207		
2.0 TFSI	1984	147	4	03.06-08.15	BPY, BWA		EPBMWN5-D003D	94436		
2.0 TFSI	1984	147	4	03.06-08.15	CCTA, CAWB		EPBMWN5-D027H	91976		
2.0 TFSI	1984	147	4	03.06-08.15	CCZA		EPBMWT5-A027H	96756		
2.0 TSI	1984	155	4	11.09-08.15	CCZB		EPBMWT5-A027H	96756		
3.2 V6	3189	184	6	06.06-05.09	BUB, CBRA		EPBMFT5-D038H	96961		
3.6 V6	3597	191	6	05.09-11.10	CDVA		EPBMFT5-D040H	97032		

FOX HATCHBACK (5Z1, 5Z3, 5Z4)

1.4 TDI	1422	51	3	04.05-12.09	BNM		EPBMFN5-D019H	95991		
---------	------	----	---	-------------	-----	--	---------------	-------	--	--

GOLF III (1H1, 1H5)

1.9 SDI	1896	47	4	07.95-08.97	AEY		EPBMWN6-D029H	90628		
1.9 TDI	1896	66	4	03.94-04.99	AHU, 1Z		EPBMWN6-D029H	90628		
1.9 TDI	1896	81	4	04.96-04.99	AFN		EPBMWN6-D029H	90628		

GOLF IV (1J1, 1E7, 1J5)

1.6	1595	74	4	08.97-05.04	AKL, APF, AEH		EPBMWT4-D014H	93236		
1.6	1595	74	4	05.99-04.02	AKL, AEH, APF		EPBMWT4-D014H	93236		
1.6	1595	75	4	08.00-06.05	AVU, BFQ		EPBMWT4-D014H	93236		
1.6	1595	75	4	08.00-06.06	AVU		EPBMWT4-D014H	93236		
1.6 FSI	1598	81	4	01.02-06.05	BAD		EPBMFT5-D005P	90557		
1.8	1781	92	4	08.97-06.05	AGN, BAF		EPBMFT5-D005P	90557		



MAF



l kW
C
Y
I



Type-N°

Stock-N°

Plug In
Alternative
Type-N°

Plug In
Stock-N°

VW

GOLF IV (1J1, 1E7, 1J5)

1.8 T	1781	110	4	08.97-06.05	ARZ		EPBMFN5-D016H	96999	EPBMFN5-D002P	91609
1.8 T	1781	110	4	08.97-06.05	AUM		EPBMFN5-D012H	96277	EPBMFN5-D002P	91609
1.8 T GTI	1781	132	4	08.01-06.05	AUQ		EPBMFN5-D012H	96277	EPBMFN5-D002P	91609
1.9 TDI 4motion	1896	66	4	07.98-04.02	AGR	EngineNo.>1JXP073001; EngineNo.>1JXW181001; EngineNo.>1JXB045001; EngineNo.>1JXD092001	EPBMFN5-D003H	95299	EPBMFN5-D002P	91609
1.9 TDI	1896	66	4	05.99-05.06	AGR	Chass.<1JXP073000; Chass.<1JXW181000; Chass.<1JXB045000; Chass.<1JXD092000	EPBMWN6-D029H	90628		
1.9 TDI	1896	66	4	05.99-05.06	AGR	Chass.>1JXP073001; Chass.>1JXW181001; Chass.>1JXB045001; Chass.>1JXD092001	EPBMFN5-D005H	92204	EPBMFN5-D002P	91609
1.9 TDI	1896	66	4	05.99-05.06	ALH	Chass.<1J4300000	EPBMFN5-D005H	92204	EPBMFN5-D002P	91609
1.9 TDI	1896	66	4	05.99-05.06	ALH	Chass.>1J5000001	EPBMFN5-D003H	95299	EPBMFN5-D002P	91609
1.9 TDI 4motion	1896	66	4	05.99-04.02	AGR		EPBMFN5-D003H	95299	EPBMFN5-D002P	91609
1.9 TDI	1896	66	4	05.00-09.02	AGR		EPBMFN5-D005H	92204		
1.9 TDI	1896	74	4	09.00-06.05	ATD, AXR	Chass.<1J2U030000; Chass.<1J2W350000; Chass.<1J2P055000; Chass.<1J2B088000; Chass.<1J2D420000	EPBMFN5-D005H	92204	EPBMFN5-D002P	91609
1.9 TDI	1896	74	4	09.00-06.05	ATD, AXR	Chass.>1J2U030000; Chass.>1J2W350000; Chass.>1J2P055000; Chass.>1J2B088000; Chass.>1J2D420000	EPBMFN5-D003H	95299	EPBMFN5-D002P	91609
1.9 TDI 4motion	1896	74	4	09.00-06.06	ATD	EngineNo.>1J2U030000; EngineNo.>1J2W350000; EngineNo.>1J2P055000; EngineNo.>1J2B088000; EngineNo.>1J2D420000	EPBMFN5-D003H	95299	EPBMFN5-D002P	91609
1.9 TDI	1896	81	4	08.97-10.99	AHF	Chass.<1JXP073000; Chass.<1JXW181000; Chass.<1JXB045000; Chass.<1JXD092000	EPBMWN6-D029H	90628		
1.9 TDI	1896	81	4	05.99-06.01	AHF	Chass.>1J5000001	EPBMFN5-D003H	95299	EPBMFN5-D002P	91609
1.9 TDI	1896	81	4	05.99-10.99	AHF	Chass.>1JXP073001; Chass.>1JXW181001; Chass.>1JXB045001; Chass.>1JXD092001; Chass.<1J4299000	EPBMFN5-D005H	92204	EPBMFN5-D002P	91609
1.9 TDI	1896	81	4	09.00-05.04	ASV	Chass.<1J4300000	EPBMFN5-D005H	92204	EPBMFN5-D002P	91609
1.9 TDI	1896	85	4	08.99-06.01	AJM, AUJ		EPBMFN5-D005H	92204	EPBMFN5-D002P	91609
1.9 TDI 4motion	1896	85	4	09.99-06.01	AJM, AUJ		EPBMFN5-D003H	95299	EPBMFN5-D002P	91609
1.9 TDI 4motion	1896	85	4	05.99-06.01	AJM		EPBMFN5-D003H	95299	EPBMFN5-D002P	91609
1.9 TDI	1896	96	4	11.00-04.02	ASZ	Chass.<1J2600000	EPBMFN5-D013H	96315	EPBMFN5-D002P	91609
1.9 TDI 4motion	1896	96	4	11.00-04.02	ASZ	Chass.<1J2600000	EPBMFN5-D013H	96315	EPBMFN5-D002P	91609
1.9 TDI	1896	96	4	04.01-05.04	ASZ		EPBMFN5-D013H	96315		
1.9 TDI	1896	96	4	05.02-06.05	ASZ	Chass.>1J2600001	EPBMFN5-D002H	91692	EPBMFN5-D002P	91609
1.9 TDI 4motion	1896	96	4	05.02-06.05	ASZ	Chass.>1J2600001	EPBMFN5-D002H	91692	EPBMFN5-D002P	91609
1.9 TDI	1896	110	4	05.00-04.02	ARL	Chass.<1J2600000	EPBMFN5-D013H	96315	EPBMFN5-D002P	91609
1.9 TDI 4motion	1896	110	4	02.00-04.02	ARL	Chass.<1J2600000	EPBMFN5-D013H	96315	EPBMFN5-D002P	91609
1.9 TDI	1896	110	4	06.01-06.06	ARL		EPBMFN5-D002H	91692		
1.9 TDI	1896	110	4	05.02-06.05	ARL	Chass.>1J2600001	EPBMFN5-D002H	91692	EPBMFN5-D002P	91609
1.9 TDI 4motion	1896	110	4	05.02-06.05	ARL	Chass.>1J2600001	EPBMFN5-D002H	91692	EPBMFN5-D002P	91609
2.0	1984	85	4	07.98-05.04	APK, AQY, AZJ, AZG		EPBMFT5-D005P	90557		
2.0	1984	85	4	05.99-06.06	AZJ, APK, AQY		EPBMFT5-D005P	90557		



MAF



l kW
C
Y
I



Type-N°

Stock-N°

Plug In
Alternative
Type-N°

Plug In
Subtype

VW

GOLF IV (1J1, 1E7, 1J5)

2.0	1984	85	4	05.00-06.02	AWG		EPBMFN5-D016H	96999	EPBMFN5-D002P	91609
2.0 4motion	1984	85	4	10.00-06.05	AZH, AZJ		EPBMFT5-D005P	90557		
2.0 Bi-Fuel	1984	85	4	02.02-06.06	BEH		EPBMFT5-D005P	90557		
2.3 V5	2324	110	5	05.99-02.01	AGZ		EPBMFN5-D013H	96315	EPBMFN5-D002P	91609
2.3 V5 4motion	2324	110	5	05.99-02.01	AGZ		EPBMFN5-D013H	96315	EPBMFN5-D002P	91609
2.3 V5	2324	125	5	10.00-06.05	AQN		EPBMFT5-D024H	93373		
2.3 V5	2324	125	5	10.00-06.06	AQN		EPBMFN5-D013H	96315		
2.3 V5 4motion	2324	125	5	10.00-06.05	AQN		EPBMFT5-D024H	93373		
2.3 V5 4motion	2324	125	5	10.00-06.06	AQN		EPBMFN5-D013H	96315		
2.8 V6 4motion	2792	150	6	05.99-06.06	AQP, AUE, BDE		EPBMFT5-D024H	93373		
2.8 V6 4motion	2792	150	6	05.99-06.06	AQP, AUE, BDE		EPBMFN5-D013H	96315		
2.8 VR6 4motion	2792	150	6	05.99-05.00	AQP		EPBMFN5-D013H	96315		
2.8 VR6 4motion	2792	150	6	01.00-04.01	AUE		EPBMFN5-D013H	96315		
2.8 VR6 4motion	2792	150	6	05.01-06.05	BDE		EPBMFN5-D013H	96315		
3.2 R32 4motion	3189	177	6	09.02-06.05	BFH, BML		EPBMFT5-D038H	96961		

GOLF V (1K1,1K5)

1.9 TDI	1896	66	4	05.04-11.08	BXF, BRU		EPBMFN5-D003H	95299	EPBMFN5-D002P	91609
1.9 TDI	1896	77	4	10.03-11.08	BKC, BLS, BXE		EPBMFN5-D003H	95299	EPBMFN5-D002P	91609
1.9 TDI 4motion	1896	77	4	08.04-11.08	BKC, BLS, BXE		EPBMFN5-D003H	95299	EPBMFN5-D002P	91609
1.9 TDI	1896	77	4	06.07-07.09	BXE, BLS		EPBMFN5-D003H	95299		
1.9 TDI 4motion	1896	77	4	01.08-07.09	BLS		EPBMFN5-D003H	95299		
2.0 SDI	1968	55	4	01.04-11.08	BDK		EPBMFN5-D003H	95299	EPBMFN5-D002P	91609
2.0 TDI	1968	100	4	06.07-07.09	AZV		EPBMFN5-D002H	91692	EPBMFN5-D002P	91609
2.0 TDI 16V 4motion	1968	103	4	08.04-11.08	BKD		EPBMFN5-D002H	91692		
2.0 TDI 4motion	1968	103	4	08.04-11.08	BMM		EPBMFN5-D002H	91692		
2.0 TDI	1968	103	4	06.07-07.09	BMM		EPBMFN5-D002H	91692	EPBMFN5-D002P	91609
2.0 TDI 16V	1968	103	4	06.07-07.09	BKD		EPBMFN5-D002H	91692	EPBMFN5-D002P	91609
2.0 TDI	1968	125	4	11.05-11.08	BMN		EPBMFN5-D002H	91692	EPBMFN5-D002P	91609
2.0 GTI	1984	147	4	10.04-02.09	BPY		EPBMWN5-D003D	94436		
2.0 GTI	1984	147	4	10.04-02.09	CCTA, CBFA, CAWB		EPBMWN5-D027H	91976		
2.0	1984	147	4	06.07-07.09	CCTA, CAWB		EPBMWN5-D027H	91976		
2.0 GTI	1984	169	4	09.06-12.08	BYD		EPBMWN5-D003D	94436		
3.2 R32 4motion	3189	184	6	11.05-11.08	BUB, CBRA		EPBMFT5-D038H	96961		

GOLF VI (5K1, AJ5, 517)

1.6 TDI	1598	66	4	12.09-07.13	CAYB		EPBMWT3-D024H	91171		
1.6 TDI	1598	66	4	02.09-11.12	CAYB	Chass.>WWWZZZ1KZ940001	EPBMWT3-D024H	91171		
1.8 TSI	1798	118	4	06.09-01.11	CDA A		EPBMWT5-A027H	96756		
2.0 TDI	1968	81	4	10.08-11.12	CBDC		EPBMFN5-D001H	95207		
2.0 TDI	1968	81	4	01.10-07.13	CLCA		EPBMFN4-V008H	95035		
2.0 TDI	1968	81	4	11.13-05.16	CUUA		EPBMFN4-V008H	95035		
2.0 TDI	1968	100	4	10.08-11.12	CBAA		EPBMFN5-D001H	95207		
2.0 TDI	1968	100	4	10.08-11.12	CFFA		EPBMFN4-V008H	95035		
2.0 TDI	1968	100	4	07.09-07.13	CBDA		EPBMFN5-D001H	95207		
2.0 TDI	1968	100	4	07.09-07.13	CFHB		EPBMFN4-V008H	95035		



MAF



l kW
C
Y
I



Type-N°

Stock-N°

Plug In
Alternative
Type-N°

Plug In
stock-N°

VW

GOLF VI (5K1, AJ5, 517)

2.0 TDI	1968	103	4	10.08-05.13	CBAB, CJAA		EPBMFN5-D001H	95207		
2.0 TDi	1968	103	4	07.09-05.14	CBDB		EPBMFN5-D001H	95207		
2.0 TDi	1968	103	4	09.09-11.12	CFFB		EPBMFN4-V008H	95035		
2.0 TDi	1968	103	4	07.09-05.14	CFHC		EPBMFN4-V008H	95035		
2.0 TDi	1968	103	4	09.09-11.12	CJAA		EPBMFN5-D001H	95207		
2.0 TDI 4motion	1968	103	4	05.09-11.12	CBAB		EPBMFN5-D001H	95207		
2.0 TDI 4motion	1968	103	4	05.09-11.12	CFFB		EPBMFN4-V008H	95035		
2.0 TDI	1968	110	4	11.13-05.16	CUUB		EPBMFN4-V008H	95035		
2.0 TDI	1968	125	4	04.09-11.12	CBBB		EPBMFN5-D001H	95207		
2.0 TDI	1968	125	4	04.09-11.12	CFGB		EPBMFN4-V008H	95035		
2.0 GTi	1984	147	4	06.09-11.13	CCTA, CBFA		EPBMWN5-D027H	91976		
2.0 TSI	1984	147	4	07.09-07.13	CCZA		EPBMWT5-A027H	96756		
2.0 GTi	1984	155	4	04.09-11.12	CCZB		EPBMWT5-A027H	96756		
2.0 R 4motion	1984	188	4	11.09-11.13	CDLC		EPBMWN5-D003D	94436		
2.0 R 4motion	1984	199	4	11.09-11.12	CDLF		EPBMWN5-D003D	94436		

GOLF VII (5G1, BQ1, BE1, BE2, BA5, BV5, AM1, AN1)

2.0 TDI	1968	81	4	05.13-	CRVA, CYKB, CRLD, DEJB		EPBMFN4-V008H	95035		
2.0 TDI	1968	81	4	05.14-	CRVA, CRLD		EPBMFN4-V008H	95035		
2.0 TDI	1968	105	4	08.12-	CRBB, CRVC		EPBMFN4-V008H	95035		
2.0 TDI	1968	110	4	11.12-	CRLB, CRMB, CRBC, CRUA, DFGA, DCYA, DEJA		EPBMFN4-V008H	95035		
2.0 TDI 4motion	1968	110	4	11.12-	CRLB, CKFC, CRMB, CRBC, DCYA		EPBMFN4-V008H	95035		
2.0 TDI	1968	110	4	04.13-	CRLB, CRBC, CRUA, DFGA, DCYA, DEJA		EPBMFN4-V008H	95035		
2.0 TDI 4motion	1968	110	4	04.13-05.18	CRLB, CRBC		EPBMFN4-V008H	95035		
2.0 TDi BlueMotion	1968	110	4	04.13-03.17	CRLB, CRBC		EPBMFN4-V008H	95035		
2.0 TDi BlueMotion 4motion	1968	110	4	05.13-	CRBC		EPBMFN4-V008H	95035		
2.0 TDi BlueMotion 4motion	1968	110	4	04.13-03.17	CRLB, CRBC		EPBMFN4-V008H	95035		
2.0 TDI	1968	110	4	02.14-	CRLB, DFGA, DCYA		EPBMFN4-V008H	95035		
2.0 TDI 4motion	1968	110	4	12.14-05.18	CRLB, CRBC, DCYA		EPBMFN4-V008H	95035		
2.0 GTD	1968	135	4	04.13-	CUNA		EPBMFN4-V008H	95035		
2.0 TDI 4motion	1968	135	4	12.14-	CUNA, DGCA		EPBMFN4-V008H	95035		
2.0 GTD	1968	135	4	01.15-	CUNA, DGCA, DJGA		EPBMFN4-V008H	95035		

GOLF PLUS (5M1, 521)

1.6 TDI	1598	66	4	02.09-12.13	CAYB	Chass.>WWWZZZ1KZ9W900001	EPBMWT3-D024H	91171		
1.9 TDI	1896	66	4	05.05-12.08	BXF, BRU		EPBMFN5-D003H	95299	EPBMFN5-D002P	91609
1.9 TDI	1896	77	4	01.05-01.09	BKC, BLS, BXE		EPBMFN5-D003H	95299	EPBMFN5-D002P	91609
2.0 TDI	1968	81	4	01.09-12.11	CBDC, CLCA		EPBMFN5-D001H	95207		
2.0 TDI	1968	81	4	01.12-12.13	CBDC, CLCA		EPBMFN4-V008H	95035		
2.0 TDI	1968	96	4	05.05-05.07	BEE		EPBMFN5-D002H	91692		
2.0 TDI	1968	100	4	05.05-12.13	AZV		EPBMFN5-D002H	91692	EPBMFN5-D002P	91609
2.0 TDI	1968	100	4	05.05-12.13	CBDA, CFHB		EPBMFN5-D001H	95207	EPBMFN5-D002P	91609
2.0 TDI	1968	103	4	12.05-05.11	BMM		EPBMFN5-D002H	91692	EPBMFN5-D002P	91609
2.0 TDI 16V	1968	103	4	01.05-12.08	BKD		EPBMFN5-D002H	91692	EPBMFN5-D002P	91609
2.0 TDI 16V	1968	103	4	01.05-12.13	CBDB, CFHC		EPBMFN5-D001H	95207		



MAF

 kW
 C
 Y
 I

Type-Nº

Stock-Nº

Plug In
Alternative
Type-NºPlug In
Subtype

VW

GOLF PLUS (5M1, 521)

2.0 TDi	1968	103	4	11.09-08.14	CFHC		EPBMFN4-V008H	95035		
---------	------	-----	---	-------------	------	--	---------------	-------	--	--

GOLF SPORTSVAN (AM1, AN1)

2.0 TDi	1968	81	4	05.14-	CRVA, CRLD		EPBMFN4-V008H	95035		
2.0 TDi	1968	110	4	02.14-	CRLB, DFGA, DCYA		EPBMFN4-V008H	95035		

JETTA III (1K2)

1.6 TDi	1598	66	4	12.09-10.10	CAYB		EPBMWT3-D024H	91171		
1.9 TDi	1896	77	4	08.05-10.10	BKC, BLS, BXE		EPBMFN5-D003H	95299	EPBMFN5-D002P	91609
2.0 TDi	1968	100	4	09.05-10.10	AZV		EPBMFN5-D002H	91692	EPBMFN5-D002P	91609
2.0 TDi	1968	103	4	10.05-10.10	BMM		EPBMFN5-D002H	91692	EPBMFN5-D002P	91609
2.0 TDi 16V	1968	103	4	08.05-10.10	BKD		EPBMFN5-D002H	91692	EPBMFN5-D002P	91609
2.0 TDi 16V	1968	103	4	08.05-10.10	CBEA		EPBMFN5-D001H	95207	EPBMFN5-D002P	91609
2.0 TDi	1968	125	4	10.06-10.10	BMN, CEGA		EPBMFN5-D002H	91692		
2.0 TFSI	1984	147	4	10.05-10.10	BPY, BWA		EPBMWN5-D003D	94436		
2.0 TFSI	1984	147	4	10.05-10.10	CCTA, CAWB		EPBMWN5-D027H	91976		
2.0 TFSI	1984	147	4	10.05-10.10	CCZA		EPBMWT5-A027H	96756		
2.5	2480	110	5	01.06-10.10	BTK, BGP		EPBMFT5-D038H	96961		
2.5	2480	125	5	07.08-10.10	CBTA		EPBMFT5-D038H	96961		

JETTA IV (162, 163, AV3, AV2)

2.0 TDi	1968	81	4	10.10-	CLCA, CUJA		EPBMFN4-V008H	95035		
2.0 TDi	1968	103	4	02.11-	CFFB, CFHC, CLCB		EPBMFN4-V008H	95035		
2.0 TDi	1968	103	4	02.11-	CJAA		EPBMFN5-D001H	95207		
2.0 TDi	1968	110	4	08.14-	CUUB, DELA		EPBMFN4-V008H	95035		
2.0 TSi	1984	147	4	12.10-	CCTA, CBFA		EPBMWN5-D027H	91976		
2.0 TSi	1984	147	4	12.10-	CCZA		EPBMWT5-A027H	96756		

LT II BUS (2DA, 2DB, 2DC, 2DD, 2DE, 2DF, 2DG, 2DH, 2DK, 2DL, 2DM)

2.5 SDI	2461	55	5	07.96-04.01	AGX	Chass.<2DX027193	EPBMWN6-D029H	90628		
2.5 SDI	2461	55	5	07.96-04.01	AGX	Chass.>2DX027194	EPBMFN5-D015H	90376	EPBMFN5-D002P	91609
2.5 TDi	2461	61	5	05.01-07.06	BBE		EPBMFN5-D019H	95991	EPBMFN5-D002P	91609
2.5 TDi	2461	66	5	05.99-04.01	APA	Chass.>2D1013335	EPBMFN5-D019H	95991	EPBMFN5-D002P	91609
2.5 TDi	2461	66	5	05.99-04.01	APA	Chass.<2D1013334	EPBMFN5-D015H	90376	EPBMFN5-D002P	91609
2.5 TDi	2461	70	5	05.01-07.06	BBF		EPBMFN5-D019H	95991	EPBMFN5-D002P	91609
2.5 TDi	2461	75	5	05.96-08.99	AHD	Chass.<2DW040000	EPBMWN6-D029H	90628	EPBMFN5-D002P	91609
2.5 TDi	2461	75	5	05.96-08.99	AHD	Chass.>2DW040001	EPBMFN5-D015H	90376	EPBMFN5-D002P	91609
2.5 TDi	2461	80	5	05.99-05.03	ANJ	Chass.>2D1013335	EPBMFN5-D019H	95991	EPBMFN5-D002P	91609
2.5 TDi	2461	80	5	12.02-07.06	AVR		EPBMFN5-D019H	95991	EPBMFN5-D002P	91609
2.5 TDi	2461	80	5	06.03-07.06	ANJ		EPBMFN5-D019H	95991	EPBMFN5-D002P	91609
2.5 TDi	2461	80	5	-05.03	ANJ	Chass.<2D1013334	EPBMFN5-D015H	90376		
2.8 TDi	2798	92	4	07.97-05.03	AGK		EPBMFN5-D002H	91692	EPBMFN5-D002P	91609
2.8 TDi	2798	96	4	01.99-01.02	ATA		EPBMFN5-D002H	91692	EPBMFN5-D002P	91609
2.8 TDi	2799	92	4	07.97-01.02	AGK		EPBMFN5-D002H	91692	EPBMFN5-D002P	91609
2.8 TDi	2799	96	4	01.99-07.06	ATA		EPBMFN5-D002P	91609		
2.8 TDi	2799	116	4	04.02-07.06	AUH, BCQ		EPBMFN5-D002H	91692	EPBMFN5-D002P	91609

LUPO (6X1, 6E1)

1.4 FSI	1390	77	4	02.01-05.03	ARR		EPBMFT5-D005P	90557		
1.4 TDi	1422	55	3	01.99-07.05	AMF		EPBMFN5-D022H	91168	EPBMFN5-D002P	91609



MAF



l kW
C
Y
I



Type-N°

Stock-N°

Plug In
Alternative
Type-N°

Plug In
stock-N°

VW

MULTIVAN V (7HM, 7HN, 7HF, 7EF, 7EM, 7EN)

1.9 TDI	1896	62	4	01.06-11.09	BRR		EPBMFN5-D003H	95299		
1.9 TDI	1896	63	4	04.03-11.09	AXC		EPBMFN5-D003H	95299		
1.9 TDI	1896	75	4	06.06-11.09	BRS		EPBMFN5-D003H	95299		
1.9 TDI	1896	77	4	04.03-11.09	AXB		EPBMFN5-D003H	95299		
2.0 TDI	1968	62	4	09.09-08.15	CAAA		EPBMFN4-V008H	95035		
2.0 TDI	1968	75	4	09.09-08.15	CAAB		EPBMFN4-V008H	95035		
2.0 TDI	1968	84	4	05.11-08.15	CAAD		EPBMFN4-V008H	95035		
2.0 TDI	1968	100	4	05.10-08.15	CAAE, CCHB		EPBMFN4-V008H	95035		
2.0 TDI 4motion	1968	100	4	05.10-08.15	CAAE, CCHB		EPBMFN4-V008H	95035		
2.0 TDI	1968	103	4	09.09-08.15	CAAC, CCHA		EPBMFN4-V008H	95035		
2.0 TDI 4motion	1968	103	4	09.09-08.15	CAAC, CCHA		EPBMFN4-V008H	95035		
2.0 BiTDI	1968	132	4	09.09-08.15	CFCA		EPBMFN4-V008H	95035		
2.0 BiTDI 4motion	1968	132	4	09.09-08.15	CFCA		EPBMFN4-V008H	95035		
2.0 TSI	1984	110	4	07.12-08.15	CJKB		EPBMWT5-A027H	96756		
2.0 TSI	1984	150	4	05.11-08.15	CJKA		EPBMWT5-A027H	96756		
2.0 TSI 4motion	1984	150	4	07.11-08.15	CJKA		EPBMWT5-A027H	96756		
2.5 TDI	2461	96	5	04.03-11.09	BNZ		EPBMFN5-D001H	95207		
2.5 TDI 4motion	2461	96	5	07.04-11.09	BNZ		EPBMFN5-D001H	95207		
2.5 TDI	2461	120	5	11.03-11.09	BLJ		EPBMFN5-D002H	91692		
2.5 TDI	2461	128	5	04.03-11.09	BPC		EPBMFN5-D001H	95207		
2.5 TDI 4motion	2461	128	5	07.04-11.09	BPC		EPBMFN5-D001H	95207		
3.2 V6	3189	170	6	02.04-06.04	BDL		EPBMFT5-D038H	96961		
3.2 V6	3189	173	6	02.04-11.09	BKK, CFLA		EPBMFT5-D038H	96961		
3.2 V6 4motion	3189	173	6	07.04-11.09	BKK, CFLA		EPBMFT5-D038H	96961		

MULTIVAN VI (SGF, SGM, SGN, SHM, SHN) | CARAVELLE

2.0 TDI	1968	62	4	04.15-	CXGA		EPBMFN4-V008H	95035		
2.0 TDI	1968	75	4	04.15-	CAAB, CXGB		EPBMFN4-V008H	95035		
2.0 TDI	1968	81	4	07.19-	CXHC		EPBMFN4-V008H	95035		
2.0 TDI	1968	84	4	05.16-	CXHB		EPBMFN4-V008H	95035		
2.0 TDI	1968	103	4	04.15-	CAAC		EPBMFN4-V008H	95035		
2.0 TDI 4motion	1968	103	4	06.15-	CAAC		EPBMFN4-V008H	95035		
2.0 TDI	1968	110	4	04.15-	CXFA, CXHA		EPBMFN4-V008H	95035		
2.0 TDI 4motion	1968	110	4	08.15-	CXFA, CXHA		EPBMFN4-V008H	95035		
2.0 TDI	1968	132	4	04.15-	CFCA		EPBMFN4-V008H	95035		
2.0 TDI 4motion	1968	132	4	06.15-	CFCA		EPBMFN4-V008H	95035		
2.0 TDI	1968	150	4	06.15-	CXEB		EPBMFN4-V008H	95035		
2.0 TDI 4motion	1968	150	4	06.15-	CXEB		EPBMFN4-V008H	95035		

NEW BEETLE (9C1, 1C1, 1Y7)

1.6	1595	74	4	10.99-09.00	AWH		EPBMWT4-D014H	93236		
1.6	1595	75	4	06.00-09.10	AYD		EPBMWT4-D014H	93236		
1.6	1595	75	4	01.03-09.10	BFS		EPBMWT4-D014H	93236		
1.8 T	1781	110	4	10.99-10.00	AVC, APH		EPBMFT5-D005P	90557		
1.8 T	1781	110	4	10.99-09.10	AWV, AWU		EPBMFN5-D012H	96277	EPBMFN5-D002P	91609



MAF



l kW
C
Y
I



Type-N°

Stock-N°

Plug In
Alternative
Type-N°

Plug In
Subtype

VW

NEW BEETLE (9C1, 1C1, 1Y7)

1.9 TDI	1896	66	4	01.98-06.04	ALH		EPBMFN5-D003H	95299	EPBMFN5-D002P	91609
1.9 TDI	1896	74	4	02.01-09.10	ATD, BEW		EPBMFN5-D003H	95299	EPBMFN5-D002P	91609
1.9 TDI	1896	74	4	02.01-09.10	ATD	SINGLE GAUZE	EPBMFN5-D005H	92204	EPBMFN5-D002P	91609
1.9 TDI	1896	74	4	06.03-09.10	AXR		EPBMFN5-D003H	95299		
1.9 TDI	1896	77	4	07.05-09.10	BSW		EPBMFN5-D003H	95299	EPBMFN5-D002P	91609
2.0	1984	85	4	01.98-09.10	AQY, AEG, BER, AZJ, AZG		EPBMFT5-D005P	90557		
2.3 V5	2324	125	5	10.00-09.10	AQN		EPBMFT5-D024H	93373		
2.3 V5	2324	125	5	10.00-09.10	AQN		EPBMFN5-D013H	96315		
2.5	2480	110	5	07.05-09.10	BPR, BPS		EPBMFT5-D038H	96961		
RSI 3.2 4motion	3188	165	6	04.00-05.01	AXJ		EPBMFT5-D024H	93373		
RSI 3.2 4motion	3188	165	6	04.00-05.01	AXJ		EPBMFN5-D013H	96315		

PASSAT B3 / B4 (35I, 315, 3A2, 3A5)

1.9 TDI	1896	66	4	10.93-05.97	1Z, AHU		EPBMWN6-D029H	90628		
1.9 TDI	1896	81	4	03.96-05.97	AFN		EPBMWN6-D029H	90628		

PASSAT B5 (3B2, 3B3, 3B5, 3B6)

1.6	1595	74	4	10.96-11.00	ANA, ARM, AHL	 Chass.>3BW300001	EPBMWT4-D014H	93236		
1.6	1595	74	4	06.97-11.00	AHL, ADP	Chass.<3BW300000	EPBMWN3-A016H	93176		
1.6	1595	74	4	06.97-11.00	ARM, AHL, ANA	 Chass.>3BW300001	EPBMWT4-D014H	93236		
1.6	1595	75	4	11.00-05.05	ALZ		EPBMWT4-D014H	93236		
1.8	1781	92	4	06.97-01.99	ADR	Chass.<3BX400000	EPBMWN3-A016H	93176		
1.8	1781	92	4	06.97-04.99	ADR	Chass.>3BX400001	EPBMFN5-D018H	91462	EPBMFN5-D002P	91609
1.8 Syncro/4motion	1781	92	4	06.97-01.99	ADR	Chass.<3BX400000	EPBMWN3-A016H	93176		
1.8 Syncro/4motion	1781	92	4	06.97-11.00	ARG, APT, ADR	Chass.>F3BX400001	EPBMFN5-D018H	91462		
1.8	1781	92	4	02.99-11.00	ARG, APT		EPBMFN5-D018H	91462	EPBMFN5-D002P	91609
1.8 T	1781	110	4	01.99-11.00	APU, ANB		EPBMFN5-D016H	96999	EPBMFN5-D002P	91609
1.8 T 20V	1781	110	4	11.00-05.05	AWT	Chass.<3B2100000	EPBMFN5-D012H	96277	EPBMFN5-D002P	91609
1.8 T 20V	1781	110	4	11.00-05.05	AWT	Chass.>3B2100001	EPBMFN5-D025H	94062	EPBMFN5-D002P	91609
1.8 4motion	1781	125	4	03.01-05.05	AWM		EPBMFN5-D012H	96277		
1.8 T	1781	125	4	02.01-05.05	AWM		EPBMFN5-D012H	96277		
1.8 T 4motion	1781	125	4	03.01-05.05	AWM		EPBMFN5-D012H	96277		
1.9 TDI	1896	66	4	10.96-11.00	AHU	Chass.>3BWD800001; Chass.>3BWP100001; Chass.>3BWE118001	EPBMFN5-D015H	90376	EPBMFN5-D002P	91609
1.9 TDI	1896	66	4	05.98-	AHH		EPBMFN5-D015H	90376	EPBMFN5-D002P	91609
1.9 TDI	1896	74	4	02.00-11.00	AVB	Chass.<3B2E262022; Chass.<3B2P240805; Chass.<3B2P241613	EPBMFN5-D015H	90376	EPBMFN5-D002P	91609
1.9 TDI	1896	74	4	11.00-05.05	AVB	Chass.>3B2E262023; Chass.>3B2P240806; Chass.>3B2P241614	EPBMFN5-D019H	95991	EPBMFN5-D002P	91609
1.9 TDI	1896	81	4	10.96-11.00	AFN	Chass.>3BWD800001; Chass.>3BWP100001; Chass.>3BWE118001	EPBMFN5-D015H	90376	EPBMFN5-D002P	91609
1.9 TDI Syncro/4motion	1896	81	4	10.96-11.00	AFN, AVG		EPBMFN5-D015H	90376		
1.9 TDI	1896	81	4	08.99-	AVG		EPBMFN5-D015H	90376	EPBMFN5-D002P	91609
1.9 TDI	1896	85	4	08.98-11.00	AJM		EPBMFN5-D015H	90376	EPBMFN5-D002P	91609
1.9 TDI	1896	85	4	01.00-	ATJ		EPBMFN5-D015H	90376	EPBMFN5-D002P	91609



MAF



l kW
C
Y
I



Type-N°

Stock-N°

Plug In
Alternative
Type-N°

Plug In
Subtype

VW

PASSAT B5 (3B2, 3B3, 3B5, 3B6)

1.9 TDI	1896	96	4	11.00-04.01	AVF, AWX	Chass.<3B1400000	EPBMFN5-D013H	96315	EPBMFN5-D002P	91609
1.9 TDI 4motion	1896	96	4	11.00-04.01	AVF	Chass.<3B1400000	EPBMFN5-D013H	96315	EPBMFN5-D002P	91609
1.9 TDI	1896	96	4	05.01-05.05	AVF, AWX	Chass.>3B2000001	EPBMFN5-D002H	91692	EPBMFN5-D002P	91609
1.9 TDI 4motion	1896	96	4	05.01-05.05	AVF	Chass.>3B1400001	EPBMFN5-D002H	91692	EPBMFN5-D002P	91609
2.0 TDI	1968	100	4	12.03-05.05	BGW		EPBMFN5-D002H	91692	EPBMFN5-D002P	91609
2.0	1984	85	4	11.00-05.05	AZM		EPBMWT4-D014H	93236		
2.0 4motion	1984	85	4	11.00-05.05	AZM		EPBMWT4-D014H	93236		
2.0	1984	96	4	11.01-05.05	ALT		EPBMFT5-D028H	93297	EPBMFT5-D005P	90557
2.3 VR5	2324	110	5	06.97-11.00	AGZ		EPBMFN5-D013H	96315	EPBMFN5-D002P	91609
2.3 VR5 Syncro/4motion	2324	110	5	10.97-11.00	AGZ		EPBMFN5-D013H	96315	EPBMFN5-D002P	91609
2.3 V5	2324	125	5	11.00-05.05	AZX		EPBMFT5-D024H	93373		
2.3 V5 4motion	2324	125	5	11.00-05.05	AZX		EPBMFT5-D024H	93373		
2.3 VR5	2324	125	5	11.00-05.05	AZX		EPBMFT5-D024H	93373		
2.3 VR5 4motion	2324	125	5	11.00-05.05	AZX		EPBMFT5-D024H	93373		
2.3 V5	2324	125	5	01.01-05.05	AZX		EPBMFN5-D013H	96315		
2.3 V5 4motion	2324	125	5	01.01-05.05	AZX		EPBMFN5-D013H	96315		
2.3 VR5	2324	125	5	01.01-05.05	AZX		EPBMFN5-D013H	96315		
2.3 VR5 4motion	2324	125	5	01.01-05.05	AZX		EPBMFN5-D013H	96315		
2.5 TDI Syncro/4motion	2496	110	6	12.98-11.00	AFB, AKN		EPBMFT5-D032H	91598		
2.5 TDI Syncro/4motion	2496	110	6	12.98-11.00	AKN		EPBMWN5-D014H	96884		
2.5 TDI	2496	110	6	11.00-05.05	AFB		EPBMFT5-D045H	95253	EPBMFT5-D005P	90557
2.5 TDI	2496	110	6	11.00-05.05	AKN		EPBMWN5-D014H	96884	EPBMFT5-D005P	90557
2.5 TDI	2496	110	6	11.00-05.05	AKN	; Chass.>3BY200001	EPBMFT5-D005P	90557		
2.5 TDI 4motion	2496	110	6	11.00-05.05	AKN		EPBMWN5-D014H	96884		
2.5 TDI	2496	120	6	05.03-05.05	BDG		EPBMWN5-D014H	96884		
2.5 TDI 4motion	2496	132	6	01.03-05.05	BAU, BDH		EPBMWN5-D014H	96884		
2.8 V6	2771	132	6	05.97-09.99	AGE		EPBMWN3-A021H	93365		
2.8 V6	2771	142	6	06.97-11.00	ACK		EPBMWN3-A021H	93365		
2.8 V6 Syncro/4motion	2771	142	6	06.97-11.00	ACK, ALG		EPBMWN3-A021H	93365		
2.8 V6 Syncro/4motion	2771	142	6	09.98-11.00	APR		EPBMWN4-D018H	96313		
2.8 4motion	2771	142	6	11.00-05.05	AMX, ATQ		EPBMWN4-D018H	96313		
2.8 4motion	2771	142	6	11.00-05.05	ATQ, AMX		EPBMWN4-D018H	96313		
4.0 W8 4motion	3999	202	8	09.01-09.04	BDN, BDP		EPBMFT5-D038H	96961		

PASSAT B6 (3C2,3C5)

1.8 TSI	1798	112	4	11.09-07.10	CDAB		EPBMWT5-A027H	96756		
1.8 TSI	1798	112	4	11.09-07.10	CGYA		EPBMWN5-D027H	91976		
1.8 TSI	1798	118	4	05.07-07.10	BZB		EPBMWN5-D027H	91976		
1.8 TSI	1798	118	4	05.07-07.10	CDAA		EPBMWT5-A027H	96756		
1.9 TDI	1896	77	4	03.05-07.10	BKC, BLS, BXE		EPBMFN5-D003H	95299	EPBMFN5-D002P	91609
2.0 TDI	1968	81	4	11.08-07.10	CBDC		EPBMFN5-D001H	95207		
2.0 TDI	1968	88	4	11.05-05.07	BWV		EPBMFN5-D002H	91692		



MAF



l kW
C
Y
I



Type-N°

Stock-N°

Plug In
Alternative
Type-N°

Plug In
Stock-N°

VW

PASSAT B6 (3C2,3C5)

2.0 TDI	1968	88	4	11.05-05.07	BWV	Chass.<8DW104600	EPBMFN5-D002H	91692		
2.0 TDI	1968	90	4	08.05-02.06	BVE		EPBMFN5-D002H	91692		
2.0 TDI	1968	100	4	03.05-11.10	BMA		EPBMFN5-D002H	91692	EPBMFN5-D002P	91609
2.0 TDI	1968	100	4	03.05-11.10	CBAA		EPBMFN5-D001H	95207	EPBMFN5-D002P	91609
2.0 TDI	1968	103	4	03.05-05.09	BMP		EPBMFN5-D002H	91692		
2.0 TDI 16V	1968	103	4	03.05-07.10	BKP		EPBMFN5-D002H	91692	EPBMFN5-D002P	91609
2.0 TDI 16V	1968	103	4	03.05-07.10	CBAB		EPBMFN5-D001H	95207	EPBMFN5-D002P	91609
2.0 TDI 16V 4motion	1968	103	4	08.05-11.10	CBAB		EPBMFN5-D001H	95207		
2.0 TDI 4motion	1968	103	4	03.05-05.09	BMP		EPBMFN5-D002H	91692		
2.0 BlueTDI	1968	105	4	01.09-11.10	CBAC		EPBMFN5-D001H	95207		
2.0 TDI	1968	120	4	08.05-05.09	BUZ		EPBMFN5-D002H	91692	EPBMFN5-D002P	91609
2.0 TDI	1968	125	4	08.05-07.10	BMR		EPBMFN5-D002H	91692	EPBMFN5-D002P	91609
2.0 TDI 4motion	1968	125	4	05.09-07.10	CBBB		EPBMFN5-D001H	95207		
2.0 FSI	1984	147	4	07.05-07.10	BPY, AXX, BWA		EPBMWN5-D003D	94436		
2.0 FSI	1984	147	4	07.05-07.10	CCTA, CAWB, CCTB, CGYA		EPBMWN5-D027H	91976		
2.0 FSI	1984	147	4	07.05-07.10	CCZA		EPBMWT5-A027H	96756		
3.2 FSI 4motion	3168	184	6	11.05-07.10	AXZ		EPBMFT5-D040H	97032		
3.6 R36 4motion	3597	220	6	04.07-07.10	BWS		EPBMFT5-D040H	97032		

PASSAT B7 (362, 365)

1.8 TSI	1798	112	4	01.12-12.14	CDAB		EPBMWT5-A027H	96756		
1.8 TSI	1798	118	4	01.12-12.14	CDAA		EPBMWT5-A027H	96756		
2.0 TDI	1968	100	4	08.10-12.14	CFFA		EPBMFN4-V008H	95035		
2.0 TDi BlueMotion	1968	103	4	08.10-12.14	CFFB		EPBMFN4-V008H	95035		
2.0 TDI	1968	103	4	01.12-12.14	CFFB		EPBMFN4-V008H	95035		
2.0 TDI 4motion	1968	103	4	01.12-12.14	CFFB		EPBMFN4-V008H	95035		
2.0 TDI	1968	125	4	08.10-12.14	CFGB, CLLA		EPBMFN4-V008H	95035		
2.0 TDi BlueMotion	1968	125	4	08.10-12.14	CFGB, CLLA		EPBMFN4-V008H	95035		
2.0 TDI 4motion	1968	125	4	01.12-12.14	CFGB		EPBMFN4-V008H	95035		
2.0 TDI	1968	130	4	12.12-12.14	CFGC		EPBMFN4-V008H	95035		
2.0 TDI 4motion	1968	130	4	01.13-12.14	CFGC		EPBMFN4-V008H	95035		
2.0 TSI	1984	155	4	11.10-12.14	CCZB		EPBMWT5-A027H	96756		

PASSAT B8 (3G2, CB2, 3G5, CB5)

2.0 TDI	1968	110	4	11.14-	CRLB, DFGA, DBGA		EPBMFN4-V008H	95035		
2.0 TDI 4motion	1968	110	4	02.15-	CRLB, DFEA		EPBMFN4-V008H	95035		
2.0 TDI 4motion	1968	110	4	05.15-	CRLB		EPBMFN4-V008H	95035		
2.0 TDI 4motion	1968	110	4	05.15-	DFEA	Number of Poles:4	EPBMFN4-V008H	95035		
2.0 TDI	1968	135	4	07.15-	CUPA		EPBMFN4-V008H	95035		
2.0 TDI 4motion	1968	135	4	07.15-	CUPA		EPBMFN4-V008H	95035		
2.0 TDI	1968	140	4	11.14-	DDAA, DFCA, DFHA		EPBMFN4-V008H	95035		
2.0 TDI 4motion	1968	140	4	11.14-	DDAA, DFCA, DFHA		EPBMFN4-V008H	95035		
2.0 TDI 4motion	1968	140	4	05.15-	DDAA, DFHA		EPBMFN4-V008H	95035		
2.0 TDI 4motion	1968	140	4	05.15-	DFCA	Number of Poles:4	EPBMFN4-V008H	95035		

PASSAT CC B6 (357)

1.8 TSI	1798	112	4	11.08-05.10	CDAB		EPBMWT5-A027H	96756		
---------	------	-----	---	-------------	------	--	---------------	-------	--	--



MAF



l kW
C
Y
I



Type-N°

Stock-N°

Plug In
Alternative
Type-N°

Plug In
stock-N°

VW

PASSAT CC B6 (357)

1.8 TSI	1798	112	4	11.08-05.10	CGYA		EPBMWN5-D027H	91976		
1.8 TSI	1798	118	4	06.08-01.12	BZB, CDA		EPBMWT5-A027H	96756		
1.8 TSI	1798	118	4	06.08-01.12	BZB		EPBMWN5-D027H	91976		
2.0 TDI	1968	100	4	06.08-05.11	CBAA		EPBMFN5-D001H	95207		
2.0 TDI	1968	100	4	06.08-05.11	CFFA		EPBMFN4-V008H	95035		
2.0 TDI	1968	103	4	06.08-01.12	CBAB		EPBMFN5-D001H	95207		
2.0 TDI	1968	103	4	06.08-01.12	CFFB		EPBMFN4-V008H	95035		
2.0 TDI 4motion	1968	103	4	08.09-01.12	CBAB		EPBMFN5-D001H	95207		
2.0 TDI 4motion	1968	103	4	08.09-01.12	CFFB		EPBMFN4-V008H	95035		
2.0 BlueTDI	1968	105	4	05.09-11.10	CBAC		EPBMFN5-D001H	95207		
2.0 TDI	1968	125	4	06.08-01.12	CBBB		EPBMFN5-D001H	95207		
2.0 TDI	1968	125	4	06.08-01.12	CFGB		EPBMFN4-V008H	95035		
2.0 TDI 4motion	1968	125	4	11.09-01.12	CBBB		EPBMFN5-D001H	95207		
2.0 TDI 4motion	1968	125	4	11.09-01.12	CFGB		EPBMFN4-V008H	95035		
2.0 TSI	1984	147	4	06.08-01.12	CCTA, CBFA, CAWB		EPBMWN5-D027H	91976		
2.0 TSI	1984	147	4	06.08-01.12	CCZA		EPBMWT5-A027H	96756		
2.0 TSI	1984	155	4	11.10-01.12	CCZB		EPBMWT5-A027H	96756		
3.6 FSI 4motion	3580	206	6	06.08-01.12	BLV		EPBMFT5-D040H	97032		
3.6 FSI 4motion	3597	220	6	02.08-12.11	BWS		EPBMFT5-D040H	97032		

PHAETON (3D1, 3D2, 3D3, 3D4, 3D6, 3D7, 3D8, 3D9)

3.0 V6 TDI 4motion	2967	165	6	09.04-05.07	BMK		EPBMFN5-D033H	93804		
3.0 V6 TDI 4motion	2967	171	6	06.07-11.08	CARA		EPBMFN5-D033H	93804		
3.0 V6 TDI 4motion	2967	176	6	11.08-03.16	CARB, CEXA		EPBMFN5-D033H	93804		
3.2 V6	3189	177	6	04.02-05.05	AYT, BKL		EPBMFT5-D038H	96961		
3.2 V6 4motion	3189	177	6	02.04-11.08	BKL, BRK		EPBMFT5-D038H	96961		
3.6 V6 4motion	3597	206	6	11.08-03.16	CHNA, CMVA		EPBMFT5-D040H	97032		
4.2 V8 4motion	4172	246	8	05.03-03.16	BGH, BGJ		EPBMFT5-D005P	90557		
5.0 V10 TDI 4motion	4921	230	10	11.02-10.06	AJS		EPBMFN5-D002H	91692	EPBMFN5-D002P	91609
6.0 W12 4motion	5998	309	12	04.02-12.05	BAN		EPBMFT5-D038H	96961		
6.0 W12 4motion	5998	331	12	05.05-03.16	BRN, BTT		EPBMFT5-D038H	96961		

POLO (9N_)

1.4 TDI	1422	51	3	04.05-11.09	BNM, BWB		EPBMFN5-D003H	95299	EPBMFN5-D002P	91609
1.4 TDI	1422	55	3	10.01-06.05	AMF, BAY	Chass.>9N2000000; Chass.<9N2120000	EPBMFN5-D005H	92204	EPBMFN5-D002P	91609
1.4 TDI	1422	55	3	10.01-06.05	AMF, BAY	Chass.>9N3000001	EPBMFN5-D003H	95299	EPBMFN5-D002P	91609
1.4 TDI	1422	59	3	04.05-11.09	BMS, BNV		EPBMFN5-D003H	95299	EPBMFN5-D002P	91609
1.8 GTI	1781	110	4	09.05-11.09	BJX		EPBMFN5-D012H	96277	EPBMFN5-D002P	91609
1.8 GTi Cup Edition	1781	132	4	05.06-11.09	BBU		EPBMFN5-D012H	96277		
1.9 TDI	1896	74	4	10.01-04.02	AXR, ATD	Chass.<9N2120000	EPBMFN5-D005H	92204	EPBMFN5-D002P	91609
1.9 TDI	1896	74	4	10.01-11.09	BMT		EPBMFN5-D003H	95299	EPBMFN5-D002P	91609
1.9 TDI	1896	74	4	05.02-05.05	AXR, ATD	Chass.>9N3000001	EPBMFN5-D003H	95299	EPBMFN5-D002P	91609
1.9 TDI	1896	96	4	11.03-11.09	ASZ, BLT		EPBMFN5-D002H	91692	EPBMFN5-D002P	91609

POLO III (6N1, 6N2)

1.4 TDI	1422	55	3	10.99-09.01	AMF	Chass.<6N2010000	EPBMFN5-D022H	91168	EPBMFN5-D002P	91609
---------	------	----	---	-------------	-----	------------------	---------------	-------	---------------	-------



MAF

 kW
C
Y
I

Type-Nº

Stock-Nº

Plug In
Alternative
Type-NºPlug In
Stock-Nº

VW

POLO III CLASSIC / VARIANT (6V2, 6V5)

1.6	1595	74	4	10.99-09.01	AKL, APF, AUR		EPBMWT4-D014H	93236		
100 1.6	1595	74	4	10.99-09.01	AKL, APF		EPBMWT4-D014H	93236		
90 1.9 TDI	1896	66	4	09.96-09.01	ALE, AHU		EPBMWN6-D029H	90628		
1.9 TDI	1896	66	4	05.97-09.01	ALE, AHU		EPBMWN6-D029H	90628		
1.9 TDI	1896	66	4	10.99-	ALH, AGR		EPBMFN5-D015H	90376	EPBMFN5-D002P	91609
90 1.9 TDI	1896	66	4	10.99-	ALH, AGR		EPBMFN5-D015H	90376	EPBMFN5-D002P	91609
1.9 TDI	1896	81	4	06.98-08.99	AFN		EPBMWN6-D029H	90628		
110 1.9 TDI	1896	81	4	06.98-08.99	AFN		EPBMWN6-D029H	90628		

POLO V (6R, 6R1, 6C1)

1.6 TDI	1598	55	4	06.09-	CAYA	Chass.>WWZZZ6RZA000001	EPBMWT3-D024H	91171		
1.6 TDI	1598	66	4	06.09-	CAYB	Chass.>WWZZZ6RZA000001	EPBMWT3-D024H	91171		

SCIROCCO III (137, 138)

2.0 TDI	1968	100	4	11.10-11.17	CFHB		EPBMFN4-V008H	95035		
2.0 TDi	1968	103	4	08.08-05.14	CBDB		EPBMFN5-D001H	95207		
2.0 TDi	1968	103	4	08.08-05.14	CFHC		EPBMFN4-V008H	95035		
2.0 TDI	1968	110	4	01.15-11.17	CUUB		EPBMFN4-V008H	95035		
2.0 TDi	1968	125	4	05.09-05.14	CBBB		EPBMFN5-D001H	95207		
2.0 TDi	1968	125	4	05.09-05.14	CFGB		EPBMFN4-V008H	95035		
2.0 TDI	1968	130	4	01.13-11.17	CFGC		EPBMFN4-V008H	95035		
2.0 TDI	1968	135	4	05.14-11.17	CUWA, CUXA		EPBMFN4-V008H	95035		
2.0 TSI	1984	147	4	05.08-11.09	CAWB		EPBMWN5-D027H	91976		
2.0 TSI	1984	155	4	11.09-11.17	CCZB		EPBMWT5-A027H	96756		
2.0 R	1984	188	4	11.09-11.17	CDLC		EPBMWN5-D003D	94436		

SHARAN (7M8, 7M9, 7M6)

1.8 T 20V	1781	110	4	04.00-03.10	AWC		EPBMFT5-D005P	90557		
1.9 TDI	1896	66	4	09.95-02.00	AHU, 1Z	Chass.<7MW020000	EPBMWN6-D029H	90628		
1.9 TDI	1896	66	4	09.95-02.00	AHU	Chass.>7MW020001	EPBMFN5-D005H	92204	EPBMFN5-D002P	91609
1.9 TDI	1896	66	4	03.99-03.10	ANU		EPBMFN5-D003H	95299	EPBMFN5-D002P	91609
1.9 TDI	1896	81	4	09.96-04.00	AFN	Chass.<7MW020000	EPBMWN6-D029H	90628		
1.9 TDI	1896	81	4	09.96-04.00	AFN	Chass.>7MW020001	EPBMFN5-D005H	92204	EPBMFN5-D002P	91609
1.9 TDI	1896	81	4	09.96-04.00	AVG		EPBMFN5-D005H	92204	EPBMFN5-D002P	91609
1.9 TDI	1896	85	4	04.00-03.10	BVK, AUJ		EPBMFN5-D005H	92204	EPBMFN5-D002P	91609
1.9 TDI 4motion	1896	85	4	04.00-03.10	AUJ		EPBMFN5-D003H	95299	EPBMFN5-D002P	91609
1.9 TDI	1896	96	4	11.02-03.10	ASZ		EPBMFN5-D002H	91692	EPBMFN5-D002P	91609
1.9 TDI	1896	110	4	06.05-03.10	BTB		EPBMFN5-D002H	91692		
2.0 TDI	1968	100	4	11.05-03.10	BVH		EPBMFN5-D002H	91692	EPBMFN5-D002P	91609
2.0 TDI	1968	103	4	11.05-03.10	BRT		EPBMFN5-D002H	91692	EPBMFN5-D002P	91609
2.0	1984	85	4	04.00-03.10	ATM		EPBMFT5-D005P	90557		
2.8 V6 24V	2792	150	6	04.00-03.10	AYL		EPBMFT5-D024H	93373		
2.8 V6 24V	2792	150	6	04.00-06.06	AYL		EPBMFN5-D013H	96315		
2.8 V6 24V 4motion	2792	150	6	04.00-03.10	AYL		EPBMFT5-D024H	93373		
2.8 V6 24V 4motion	2792	150	6	04.00-06.06	AYL		EPBMFN5-D013H	96315		

SHARAN (7N1, 7N2)

2.0 TDI	1968	85	4	05.11-	CFFE, CUVA, DFLD		EPBMFN4-V008H	95035		
---------	------	----	---	--------	------------------	--	---------------	-------	--	--



MAF

 l kW
C
Y
I

Type-N°

Stock-N°

Plug In
Alternative
Type-N°Plug In
stock-N°

VW

SHARAN (7N1, 7N2)

2.0 TDI	1968	100	4	05.10-	CFFA		EPBMFN4-V008H	95035		
2.0 TDI	1968	103	4	05.10-	CFFB		EPBMFN4-V008H	95035		
2.0 TDI 4motion	1968	103	4	05.11-	CFFB		EPBMFN4-V008H	95035		
2.0 TDI	1968	110	4	05.15-	CUVC, DFLA		EPBMFN4-V008H	95035		
2.0 TDI 4motion	1968	110	4	05.15-	CUVC, DFLA, DLTA		EPBMFN4-V008H	95035		
2.0 TDI	1968	125	4	08.10-	CFGB		EPBMFN4-V008H	95035		
2.0 TDI	1968	130	4	01.13-	CFGC, DLUB		EPBMFN4-V008H	95035		
2.0 TDI 4motion	1968	130	4	11.18-	DLUB		EPBMFN4-V008H	95035		
2.0 TDI	1968	135	4	05.15-	CUWA, DFMA		EPBMFN4-V008H	95035		
2.0 TDI 4motion	1968	135	4	05.16-	DFMA		EPBMFN4-V008H	95035		
2.0 TSI	1984	147	4	12.10-	CCZA		EPBMWT5-A027H	96756		

TIGUAN (5N_)

2.0 TDI	1968	81	4	05.10-07.18	CFFD, CUVE		EPBMFN4-V008H	95035		
2.0 TDI 4motion	1968	100	4	11.07-07.18	CBAA		EPBMFN5-D001H	95207		
2.0 TDI 4motion	1968	100	4	11.07-07.18	CFFA		EPBMFN4-V008H	95035		
2.0 TDI 4motion	1968	103	4	09.07-07.18	CBAB		EPBMFN5-D001H	95207		
2.0 TDI 4motion	1968	103	4	09.07-07.18	CFFB, CLJA		EPBMFN4-V008H	95035		
2.0 TDI	1968	103	4	03.08-07.18	CBAB		EPBMFN5-D001H	95207		
2.0 TDI	1968	103	4	03.08-07.18	CFFB		EPBMFN4-V008H	95035		
2.0 TDI	1968	110	4	05.15-07.18	CUVC		EPBMFN4-V008H	95035		
2.0 TDI 4motion	1968	110	4	05.15-07.18	CUVC		EPBMFN4-V008H	95035		
2.0 TDI 4motion	1968	120	4	02.08-08.09	CBBA		EPBMFN5-D001H	95207		
2.0 TDI 4motion	1968	125	4	09.07-07.18	CBBB		EPBMFN5-D001H	95207		
2.0 TDI 4motion	1968	125	4	09.07-07.18	CFGB		EPBMFN4-V008H	95035		
2.0 TDI 4motion	1968	130	4	11.12-07.18	CFGC		EPBMFN4-V008H	95035		
2.0 TDI 4motion	1968	135	4	05.15-07.18	CUWA		EPBMFN4-V008H	95035		
2.0 TFSI 4motion	1984	125	4	09.07-07.18	CAWA, CCZC		EPBMWT5-A027H	96756		
2.0 TSI 4motion	1984	132	4	05.11-07.18	CCZD		EPBMWT5-A027H	96756		
2.0 TFSI 4motion	1984	147	4	09.07-07.18	CCTA, CAWB		EPBMWN5-D027H	91976		
2.0 TFSI 4motion	1984	147	4	09.07-07.18	CCZA		EPBMWT5-A027H	96756		
2.0 TSI 4motion	1984	155	4	05.11-07.18	CCZB		EPBMWT5-A027H	96756		

TIGUAN (AD1, AX1, BW2)

2.0 TDI	1968	81	4	08.16-	CYKC		EPBMFN4-V008H	95035		
2.0 TDI	1968	85	4	05.16-	DFGC		EPBMFN4-V008H	95035		
2.0 TDI	1968	110	4	01.16-	DFGA		EPBMFN4-V008H	95035		
2.0 TDI 4motion	1968	110	4	01.16-	DFGA, DBGK		EPBMFN4-V008H	95035		
2.0 TDI 4motion	1968	140	4	04.16-	DFHA		EPBMFN4-V008H	95035		

TOUAREG (7LA, 7L6, 7L7)

2.5 R5 TDI	2461	120	5	08.03-05.10	BLK		EPBMFN5-D002H	91692	EPBMFN5-D002P	91609
2.5 R5 TDI	2461	120	5	08.03-05.10	BPD		EPBMFN5-D001H	95207	EPBMFN5-D002P	91609
2.5 R5 TDI	2461	128	5	01.03-05.10	BAC		EPBMFN5-D002H	91692	EPBMFN5-D002P	91609
2.5 R5 TDI	2461	128	5	01.03-05.10	BPE		EPBMFN5-D001H	95207	EPBMFN5-D002P	91609
3.0 TDI	2967	155	6	04.06-05.10	BUN, CASB	OE 420133471	EPBMWT5-V013D	92480		



MAF

 C
Y
I
kW

Type-N°

Stock-N°

Plug In
Alternative
Type-N°Plug In
Subtype

VW

TOUAREG (7LA, 7L6, 7L7)

3.0 TDI	2967	155	6	11.08-05.10	BUN, CASB	OE 059906461N; Chass.>7L9028701	EPBMWT5-A025H	93777		
3.0 V6 TDI	2967	165	6	11.04-05.10	BKS, CATA		EPBMFN5-D033H	93804		
3.0 V6 TDI	2967	165	6	11.04-05.10	BKS, CATA	OE 420133471	EPBMWT5-V013D	92480		
3.0 V6 TDI	2967	165	6	11.08-05.10	BKS, CATA	OE 059906461N; Chass.>7L9028701	EPBMWT5-A025H	93777		
3.0 V6 TDI	2967	176	6	11.07-05.10	CASA, CASC	OE 420133471	EPBMWT5-V013D	92480		
3.0 V6 TDI	2967	176	6	11.08-05.10	CASC, CASA	OE 059906461N; Chass.>7L9028701	EPBMWT5-A025H	93777		
3.2 V6	3189	162	6	10.02-11.06	AZZ, BKJ, BMX, BMW, BRJ, BAA		EPBMFT5-D038H	96961		
3.2 V6	3189	177	6	11.04-11.06	BMW		EPBMFT5-D038H	96961		
3.6 V6 FSI	3597	206	6	10.05-05.10	BHK, BHL		EPBMFT5-D040H	97032		
4.2 V8	4172	228	8	12.02-11.06	AXQ, BHX		EPBMFT5-D005P	90557		
5.0 V10 TDI	4921	230	10	10.02-05.10	BLE, AYH		EPBMFN5-D002H	91692	EPBMFN5-D002P	91609
5.0 R50 TDI	4921	257	10	08.07-05.10	CBWA		EPBMFN5-D002H	91692		
6.0 W12	5998	331	12	08.04-05.10	BJN, CFRA		EPBMFT5-D038H	96961		

TOUAREG (7P5, 7P6)

3.0 V6 TDI	2967	150	6	01.10-03.18	CASD, CJMA, CRCD, CVWA	OE 420133471	EPBMWT5-V013D	92480		
3.0 V6 TDI	2967	150	6	01.10-03.18	CJMA, CASD	OE 059906461N	EPBMWT5-A025H	93777		
3.0 V6 TDI	2967	176	6	01.10-03.18	CNRB, CASA	OE 059906461N	EPBMWT5-A025H	93777		
3.0 V6 TDI	2967	180	6	05.11-03.18	CJGD, CRCA	OE 059906461N	EPBMWT5-A025H	93777		
4.2 V8 TDI	4134	250	8	01.10-03.18	CKDA		EPBMWT5-A027H	96756		

TOURAN (1T1, 1T2)

1.9 TDI	1896	66	4	11.04-05.10	BXF, BRU		EPBMFN5-D003H	95299	EPBMFN5-D002P	91609
1.9 TDI	1896	74	4	02.03-05.04	AVQ		EPBMFN5-D003H	95299	EPBMFN5-D002P	91609
1.9 TDI	1896	77	4	08.03-05.10	BKC, BLS, BXE		EPBMFN5-D003H	95299	EPBMFN5-D002P	91609
2.0 TDI	1968	100	4	02.03-11.06	AZV		EPBMFN5-D002H	91692	EPBMFN5-D002P	91609
2.0 TDI 16V	1968	103	4	08.03-11.06	BKD		EPBMFN5-D002H	91692	EPBMFN5-D002P	91609
2.0 TDI	1968	103	4	12.05-11.06	BMM		EPBMFN5-D002H	91692	EPBMFN5-D002P	91609
2.0 TDI	1968	125	4	12.05-11.06	BMN		EPBMFN5-D002H	91692	EPBMFN5-D002P	91609

TOURAN (1T3)

1.6 TDI	1598	66	4	05.10-05.15	CAYB		EPBMWT3-D024H	91171		
2.0 TDI	1968	81	4	11.10-05.15	CFHF, CLCA		EPBMFN4-V008H	95035		
2.0 TDI	1968	103	4	05.10-05.15	CFHC		EPBMFN5-D001H	95207		
2.0 TDI	1968	125	4	05.10-01.13	CFJA		EPBMFN5-D001H	95207		
2.0 TDI	1968	130	4	01.13-05.15	CFJB		EPBMFN4-V008H	95035		

TOURAN (5T1)

2.0 TDI	1968	81	4	11.15-	CRVA, CYKB, DFEB, DFGB		EPBMFN4-V008H	95035		
2.0 TDI	1968	110	4	05.15-	DFEA, DFGA		EPBMFN4-V008H	95035		
2.0 TDI	1968	140	4	11.15-07.19	DFHA		EPBMFN4-V008H	95035		

TRANSPORTER IV (70_, 7D, 7D_)

1.9 TD	1896	50	4	10.92-04.03	ABL		EPBMFN5-D019H	95991		
2.5 TDI	2461	65	5	05.98-04.03	AJT	Chass.<701X047893; Chass.<701H048284	EPBMFN5-D015H	90376	EPBMFN5-D002P	91609



MAF



l kW
C
Y
I



Type-N°

Stock-N°

Plug In
Alternative
Type-N°

Plug In
stock-N°

VW

TRANSPORTER IV (70_, 7D, 7D_)

2.5 TDI	2461	65	5	05.98-04.03	AJT	Chass.>701X047894; Chass.>701H048285	EPBMFN5-D019H	95991	EPBMFN5-D002P	91609
2.5 TDI	2461	75	5	09.95-04.98	ACV		EPBMWN6-D029H	90628		
2.5 TDI	2461	75	5	05.98-	ACV	Chass.<701X047893; Chass.<701H048284	EPBMFN5-D015H	90376	EPBMFN5-D002P	91609
2.5 TDI	2461	75	5	05.98-04.03	ACV	Chass.>701X047894; Chass.>701H048285	EPBMFN5-D019H	95991	EPBMFN5-D002P	91609
2.5 TDI Syncro	2461	75	5	05.98-	ACV	Chass.<701X047893; Chass.<701H048284	EPBMFN5-D015H	90376	EPBMFN5-D002P	91609
2.5 TDI Syncro	2461	75	5	05.98-04.03	ACV	Chass.>701X047894; Chass.>701H048285	EPBMFN5-D019H	95991	EPBMFN5-D002P	91609
2.5 TDI	2461	75	5	11.99-	AUF	Chass.<701X047893; Chass.<701H048284	EPBMFN5-D015H	90376	EPBMFN5-D002P	91609
2.5 TDI	2461	75	5	11.99-04.03	AUF	Chass.>701X047894; Chass.>701H048285	EPBMFN5-D019H	95991	EPBMFN5-D002P	91609
2.5	2461	85	5	05.99-04.03	APL, AVT		EPBMWT4-D014H	93236		
2.5	2461	85	5	05.99-04.03	AVT, APL		EPBMWT4-D014H	93236		
2.5 Syncro	2461	85	5	05.99-04.03	APL, AVT		EPBMWT4-D014H	93236		
2.5 Syncro	2461	85	5	05.99-04.03	AVT, APL		EPBMWT4-D014H	93236		
2.5 TDI	2461	111	5	05.98-05.00	AHY	Chass.<701001319	EPBMFN5-D013H	96315	EPBMFN5-D002P	91609
2.5 TDI	2461	111	5	05.98-09.00	AHY	Chass.>701001320	EPBMFN5-D002H	91692	EPBMFN5-D002P	91609
2.5 TDI	2461	111	5	05.98-09.00	AXG		EPBMFN5-D002H	91692	EPBMFN5-D002P	91609
2.8 VR6	2792	150	6	06.00-04.03	AMV, AXK		EPBMFN5-D013H	96315		
2.8 VR6	2792	150	6	04.00-04.03	AMV		EPBMFT5-D024H	93373		
2.8 VR6	2792	150	6	04.00-04.03	AMV		EPBMFN5-D013H	96315		

TRANSPORTER V (7H_, 7E_, 7J_, 7F_)

1.9 TDI	1896	62	4	01.06-11.09	BRR		EPBMFN5-D003H	95299		
1.9 TDI	1896	63	4	04.03-11.09	AXC		EPBMFN5-D003H	95299	EPBMFN5-D002P	91609
1.9 TDI	1896	75	4	06.06-11.09	BRS		EPBMFN5-D003H	95299	EPBMFN5-D002P	91609
1.9 TDI	1896	77	4	04.03-11.09	AXB		EPBMFN5-D003H	95299	EPBMFN5-D002P	91609
2.0 TDI	1968	62	4	09.09-08.15	CAAA		EPBMFN4-V008H	95035		
2.0 TDI	1968	75	4	09.09-08.15	CAAB		EPBMFN4-V008H	95035		
2.0 TDI	1968	84	4	05.11-08.15	CAAD		EPBMFN4-V008H	95035		
2.0 TDI	1968	100	4	05.10-08.15	CAAE, CCHB		EPBMFN4-V008H	95035		
2.0 TDI	1968	100	4	05.10-08.15	CAAE		EPBMFN4-V008H	95035		
2.0 TDI 4motion	1968	100	4	05.10-08.15	CAAE, CCHB		EPBMFN4-V008H	95035		
2.0 TDI	1968	103	4	09.09-08.15	CAAC, CCHA		EPBMFN4-V008H	95035		
2.0 TDI	1968	103	4	09.09-08.15	CAAC		EPBMFN4-V008H	95035		
2.0 TDI 4motion	1968	103	4	09.09-08.15	CAAC, CCHA		EPBMFN4-V008H	95035		
2.0 TDI 4motion	1968	103	4	09.09-08.15	CAAC		EPBMFN4-V008H	95035		
2.0 BiTDI	1968	132	4	09.09-08.15	CFCA		EPBMFN4-V008H	95035		
2.0 BiTDI 4motion	1968	132	4	09.09-08.15	CFCA		EPBMFN4-V008H	95035		
2.0 TSI	1984	110	4	07.12-08.15	CJKB		EPBMWT5-A027H	96756		
2.0 TSI	1984	150	4	05.11-08.15	CJKA		EPBMWT5-A027H	96756		
2.0 TSI 4motion	1984	150	4	07.11-08.15	CJKA		EPBMWT5-A027H	96756		
2.5 TDI	2461	96	5	04.03-11.09	AXD		EPBMFN5-D003H	95299	EPBMFN5-D002P	91609
2.5 TDI	2461	96	5	04.03-11.09	BNZ		EPBMFN5-D001H	95207	EPBMFN5-D002P	91609
2.5 TDI 4motion	2461	96	5	07.04-11.09	BNZ		EPBMFN5-D001H	95207		
2.5 TDi	2461	120	5	11.03-11.09	BLJ		EPBMFN5-D002H	91692		



MAF



l kW
C
Y
I



Type-N°

Stock-N°

Plug In
Alternative
Type-N°

Plug In
Stock-N°

VW

TRANSPORTER V (7H_, 7E_, 7J_, 7F_)

2.5 TDI	2461	128	5	04.03-11.09	AXE		EPBMFN5-D003H	95299	EPBMFN5-D002P	91609
2.5 TDI	2461	128	5	04.03-11.09	BPC		EPBMFN5-D001H	95207	EPBMFN5-D002P	91609
2.5 TDI 4motion	2461	128	5	07.04-11.09	AXE, BPC		EPBMFN5-D002H	91692		
2.5 TDI 4motion	2461	128	5	04.04-11.09	BPC		EPBMFN5-D001H	95207		
3.2 4motion	3189	170	6	11.03-11.09	BDL		EPBMFT5-D038H	96961		
3.2 V6 4motion	3189	170	6	11.03-11.09	BDL		EPBMFT5-D038H	96961		
3.2 V6	3189	170	6	02.04-06.04	BDL		EPBMFT5-D038H	96961		
3.2 4motion	3189	173	6	11.03-11.09	BKK, CFLA		EPBMFT5-D038H	96961		
3.2 V6	3189	173	6	08.03-05.06	BKK		EPBMFT5-D038H	96961		
3.2 V6 4motion	3189	173	6	11.03-11.09	BKK, CFLA		EPBMFT5-D038H	96961		
3.2 V6	3189	173	6	02.04-11.09	BKK, CFLA		EPBMFT5-D038H	96961		

TRANSPORTER VI (SGA, SGH, SHA, SHH, SGB, SGG, SGJ, SGC, SHB, SHJ, SFD, SFE, SFL, SFZ, SJD, SJ)

2.0 TDI	1968	62	4	04.15-	CAAA, CXGA		EPBMFN4-V008H	95035		
2.0 TDI	1968	66	4	10.19-	CXGD		EPBMFN4-V008H	95035		
2.0 TDI	1968	75	4	04.15-	CAAB, CXGB		EPBMFN4-V008H	95035		
2.0 TDI	1968	81	4	07.19-	CXHC		EPBMFN4-V008H	95035		
2.0 TDI	1968	84	4	05.16-	CXHB		EPBMFN4-V008H	95035		
2.0 TDI	1968	103	4	04.15-	CAAC		EPBMFN4-V008H	95035		
2.0 TDI 4motion	1968	103	4	06.15-	CAAC		EPBMFN4-V008H	95035		
2.0 TDI	1968	110	4	04.15-	CXFA, CXHA		EPBMFN4-V008H	95035		
2.0 TDI 4motion	1968	110	4	08.15-	CXFA, CXHA		EPBMFN4-V008H	95035		
2.0 TDI	1968	132	4	04.15-	CFCA		EPBMFN4-V008H	95035		
2.0 TDI 4motion	1968	132	4	06.15-	CFCA		EPBMFN4-V008H	95035		
2.0 TDI	1968	150	4	06.15-	CXEB		EPBMFN4-V008H	95035		
2.0 TDI 4motion	1968	150	4	06.15-	CXEB		EPBMFN4-V008H	95035		

TRANSPORTER VI PLATFORM/CHASSIS (SFD, SFE, SFL, SFZ, SJD, SJ)

2.0 TDI	1968	62	4	04.15-06.16	CAAA, CXGA		EPBMFN4-V008H	95035		
2.0 TDI	1968	66	4	10.19-	CXGD		EPBMFN4-V008H	95035		
2.0 TDI	1968	75	4	04.15-	CAAB, CXGB		EPBMFN4-V008H	95035		
2.0 TDI	1968	81	4	07.19-	CXHC		EPBMFN4-V008H	95035		
2.0 TDI	1968	84	4	05.16-	CXHB		EPBMFN4-V008H	95035		
2.0 TDI	1968	103	4	04.15-	CAAC		EPBMFN4-V008H	95035		
2.0 TDI 4motion	1968	103	4	06.15-	CAAC		EPBMFN4-V008H	95035		
2.0 TDI	1968	110	4	08.15-	CXHA		EPBMFN4-V008H	95035		
2.0 TDI 4motion	1968	110	4	05.16-	CXHA		EPBMFN4-V008H	95035		
2.0 TDI	1968	132	4	04.15-	CFCA		EPBMFN4-V008H	95035		
2.0 TDI 4motion	1968	132	4	06.15-	CFCA		EPBMFN4-V008H	95035		

T-ROC (A11)

2.0 TDI 4motion	1968	110	4	09.17-	DFFA		EPBMFN4-V008H	95035		
2.0 TDI	1968	110	4	03.18-	DFFA		EPBMFN4-V008H	95035		
2.0 TDI 4motion	1968	140	4	07.19-	DFHA		EPBMFN4-V008H	95035		



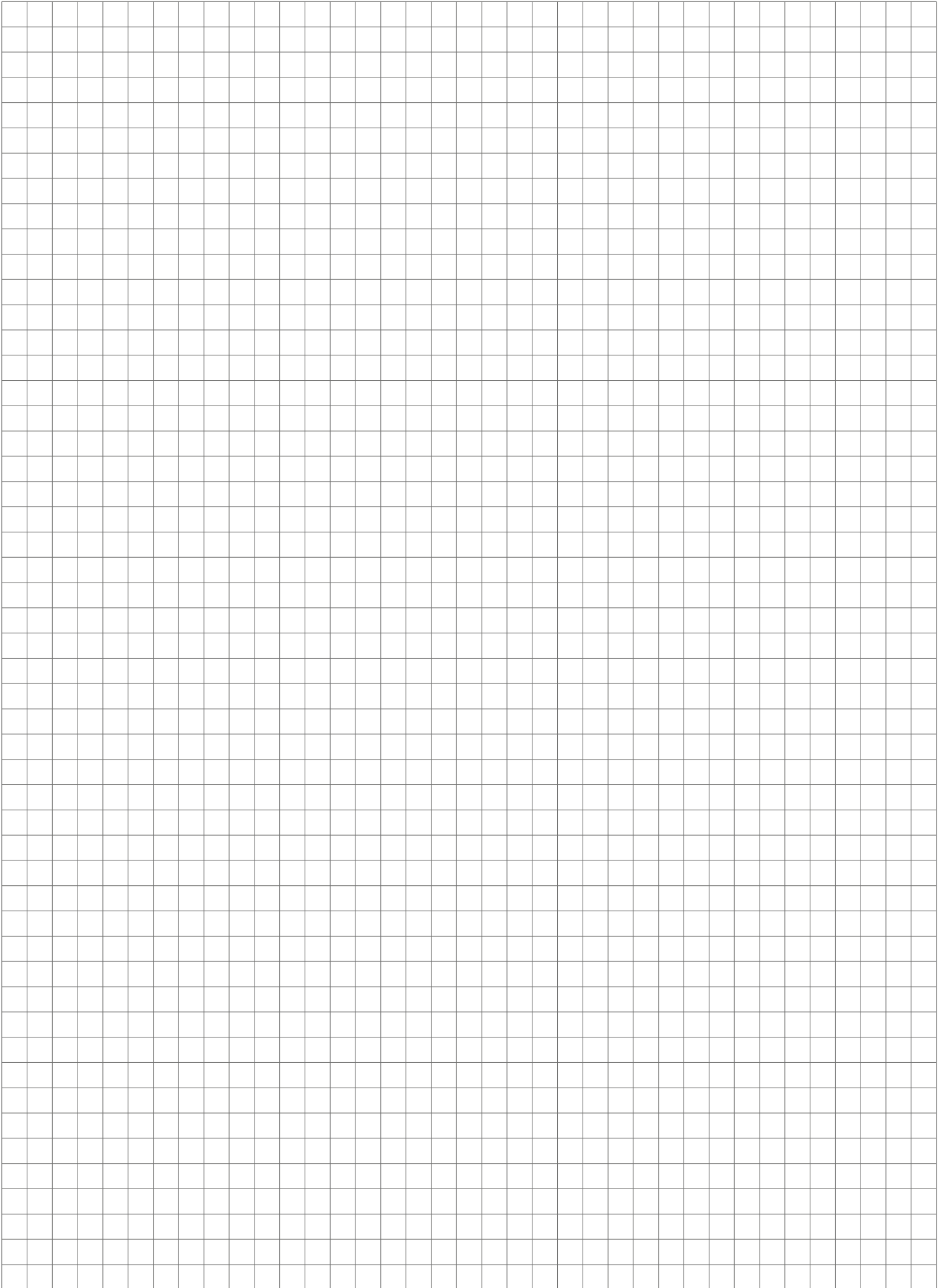

EPBMFN3-A028H **Stock No. 94128**





Info	Diameter IN	Diameter OUT	Length
	70	70	80

EPBMFN4-D011H **Stock No. 94586**

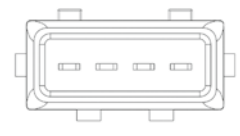

Info	Diameter IN	Diameter OUT	Length
	-	-	86

EPBMFN4-A035H **Stock No. 97899**

Info	Diameter IN	Diameter OUT	Length
	70	70	130

EPBMFN4-D014H **Stock No. 92888**



Info	Diameter IN	Diameter OUT	Length
	82	83	96

EPBMFN4-D004H **Stock No. 91534**



Info	Diameter IN	Diameter OUT	Length
	80	80	105

EPBMFN4-D040H **Stock No. 96545**



Info	Diameter IN	Diameter OUT	Length
	70	70	130

EPBMFN4-D009H **Stock No. 96113**



Info	Diameter IN	Diameter OUT	Length
	-	-	85

EPBMFN4-V007H **Stock No. 93735**



Info	Diameter IN	Diameter OUT	Length
	80	80	100

EPBMFN4-V008H **Stock No. 95035**



Info	Diameter IN	Diameter OUT	Length
	80	80	110

EPBMFN4-V026H **Stock No. 94497**



Info	Diameter IN	Diameter OUT	Length
	70	70	96

EPBMFN4-V010H **Stock No. 97588**

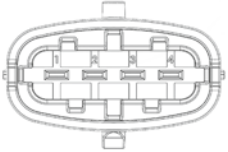
Info	Diameter IN	Diameter OUT	Length
	70	70	96,1

EPBMFN4-V031H **Stock No. 96741**

Info	Diameter IN	Diameter OUT	Length
	60	60	96

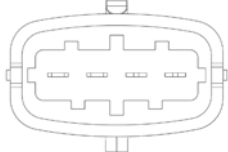
EPBMFN4-V017H **Stock No. 96226**



Info	Diameter IN	Diameter OUT	Length
	70	70	96

EPBMFN5-A029H **Stock No. 90647**



Info	Diameter IN	Diameter OUT	Length
	70	70	110

EPBMFN4-V020H **Stock No. 90971**



Info	Diameter IN	Diameter OUT	Length
	80,2	80	90

EPBMFN5-A038H **Stock No. 93095**



Info	Diameter IN	Diameter OUT	Length
	70	70	96

EPBMFN5-D001H **Stock No. 95207**



Info	Diameter IN	Diameter OUT	Length
	80	80	110

EPBMFN5-D004P **Stock No. 93343**



Info	Diameter IN	Diameter OUT	Length
	-	-	-

EPBMFN5-D002H **Stock No. 91692**



Info	Diameter IN	Diameter OUT	Length
	81	80	110

EPBMFN5-D005H **Stock No. 92204**



Info	Diameter IN	Diameter OUT	Length
	70	70	97

EPBMFN5-D002P **Stock No. 91609**

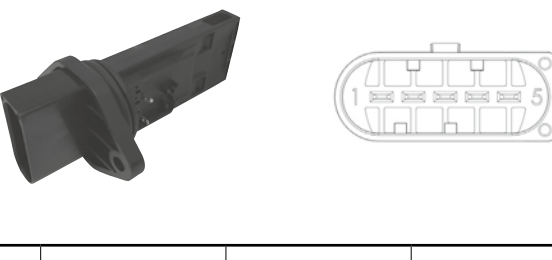

Info	Diameter IN	Diameter OUT	Length
	-	-	-

EPBMFN5-D012H **Stock No. 96277**



Info	Diameter IN	Diameter OUT	Length
	70	70	97

EPBMFN5-D003H **Stock No. 95299**



Info	Diameter IN	Diameter OUT	Length
	70	70	95

EPBMFN5-D013H **Stock No. 96315**



Info	Diameter IN	Diameter OUT	Length
	78	78	108

EPBMFN5-D015H **Stock No. 90376**



Info	Diameter IN	Diameter OUT	Length
	70	69	118,5

EPBMFN5-D021H **Stock No. 90140**



Info	Diameter IN	Diameter OUT	Length
	80	80	110

EPBMFN5-D016H **Stock No. 96999**



Info	Diameter IN	Diameter OUT	Length
	70	70	97

EPBMFN5-D022H **Stock No. 91168**



Info	Diameter IN	Diameter OUT	Length
	70	70	96

EPBMFN5-D018H **Stock No. 91462**



Info	Diameter IN	Diameter OUT	Length
	81	74	105

EPBMFN5-D023H **Stock No. 97946**



Info	Diameter IN	Diameter OUT	Length
	78	78	108

EPBMFN5-D019H **Stock No. 95991**



Info	Diameter IN	Diameter OUT	Length
	69,5	70	117

EPBMFN5-D025H **Stock No. 94062**



Info	Diameter IN	Diameter OUT	Length
	70	70	95

EPBMFN5-D027H **Stock No. 94938**



Info	Diameter IN	Diameter OUT	Length
	79	79	130

EPBMFN5-V005D **Stock No. 90496**



Info	Diameter IN	Diameter OUT	Length
	-	-	-

EPBMFN5-D033H **Stock No. 93804**



Info	Diameter IN	Diameter OUT	Length
	92	77,5	137,5

EPBMFN5-V032H **Stock No. 95044**



Info	Diameter IN	Diameter OUT	Length
	86	84	100

EPBMFN5-D047H **Stock No. 91140**



Info	Diameter IN	Diameter OUT	Length
	81	80	110

EPBMFN5-V043H **Stock No. 93581**

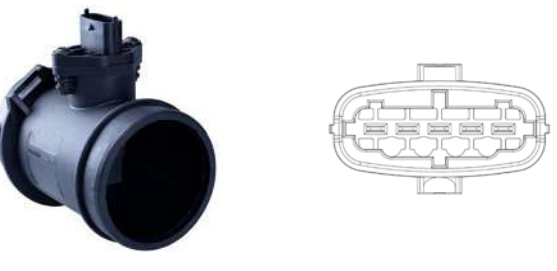

Info	Diameter IN	Diameter OUT	Length
	80	80	130

EPBMFN5-V001D **Stock No. 95368**



Info	Diameter IN	Diameter OUT	Length
	70	70	96

EPBMFN6-R030H **Stock No. 90274**



Info	Diameter IN	Diameter OUT	Length
	70	70,3	119

EPBMFT4-D050H **Stock No. 94911**



Info	Diameter IN	Diameter OUT	Length
	70	70	96

EPBMFT5-A001H **Stock No. 93740**



Info	Diameter IN	Diameter OUT	Length
	83	83	90

EPBMFT4-V004H **Stock No. 90957**



Info	Diameter IN	Diameter OUT	Length
	70	70	96

EPBMFT5-A051H **Stock No. 90866**



Info	Diameter IN	Diameter OUT	Length
	80	80	106

EPBMFT4-V048H **Stock No. 95493**



Info	Diameter IN	Diameter OUT	Length
	70	70	80

EPBMFT5-A052H **Stock No. 95671**



Info	Diameter IN	Diameter OUT	Length
	70	70	110

EPBMFT4-V061H **Stock No. 94528**

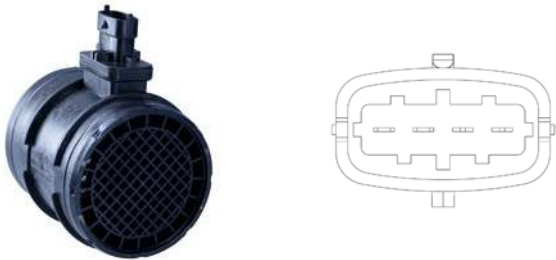

Info	Diameter IN	Diameter OUT	Length
	80	80	90

EPBMFT5-A063H **Stock No. 91029**



Info	Diameter IN	Diameter OUT	Length
	70	84	110

EPBMFT5-D003P **Stock No. 96835**



Info	Diameter IN	Diameter OUT	Length
	-	-	-

EPBMFT5-D014H **Stock No. 95484**



Info	Diameter IN	Diameter OUT	Length
	70	70	96

EPBMFT5-D005P **Stock No. 90557**



Info	Diameter IN	Diameter OUT	Length
	-	-	-

EPBMFT5-D015H **Stock No. 92304**



Info	Diameter IN	Diameter OUT	Length
	110	110	83,5

EPBMFT5-D009H **Stock No. 95803**



Info	Diameter IN	Diameter OUT	Length
	69,9	70	129

EPBMFT5-D016H **Stock No. 95579**



Info	Diameter IN	Diameter OUT	Length
	70	70	97

EPBMFT5-D012H **Stock No. 93496**



Info	Diameter IN	Diameter OUT	Length
	70	69,5	131,5

EPBMFT5-D018H **Stock No. 96224**



Info	Diameter IN	Diameter OUT	Length
	83	82	96

EPBMFT5-D023H **Stock No. 93770**



Info	Diameter IN	Diameter OUT	Length
	112	112	83,5

EPBMFT5-D032H **Stock No. 91598**



Info	Diameter IN	Diameter OUT	Length
	80	80	130

EPBMFT5-D024H **Stock No. 93373**



Info	Diameter IN	Diameter OUT	Length
	80	80	110

EPBMFT5-D034H **Stock No. 96295**



Info	Diameter IN	Diameter OUT	Length
	80	80	96

EPBMFT5-D025H **Stock No. 90977**

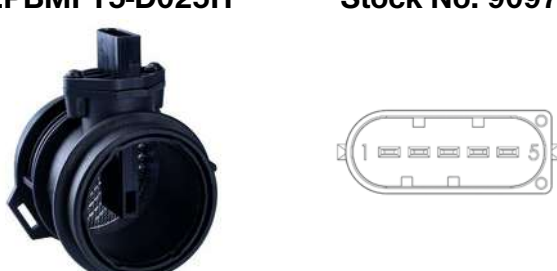

Info	Diameter IN	Diameter OUT	Length
	85	83	99

EPBMFT5-D036H **Stock No. 90481**



Info	Diameter IN	Diameter OUT	Length
	70	70	96

EPBMFT5-D028H **Stock No. 93297**



Info	Diameter IN	Diameter OUT	Length
	80	75	106

EPBMFT5-D038H **Stock No. 96961**



Info	Diameter IN	Diameter OUT	Length
	84	86	100

EPBMFT5-D040H **Stock No. 97032**



Info	Diameter IN	Diameter OUT	Length
	84	86	100

EPBMFT5-D047H **Stock No. 97067**





Info	Diameter IN	Diameter OUT	Length
	84	86	100

EPBMFT5-D041H **Stock No. 97661**





Info	Diameter IN	Diameter OUT	Length
	80	79	130

EPBMFT5-D054H **Stock No. 94591**

Info	Diameter IN	Diameter OUT	Length
	70	70	97

EPBMFT5-D043H **Stock No. 90272**

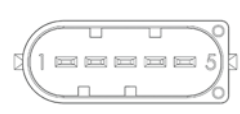
Info	Diameter IN	Diameter OUT	Length
	85	84	100,5

EPBMFT5-D056H **Stock No. 90827**



Info	Diameter IN	Diameter OUT	Length
	92	92	137

EPBMFT5-D045H **Stock No. 95253**

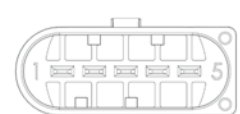
Info	Diameter IN	Diameter OUT	Length
	80	79	130,5

EPBMFT5-D060H **Stock No. 95878**





Info	Diameter IN	Diameter OUT	Length
	92	92	130

EPBMFT5-T001D **Stock No. 94095**

Info	Diameter IN	Diameter OUT	Length
	-	-	-

EPBMFT5-V002D **Stock No. 97692**

Info	Diameter IN	Diameter OUT	Length
	-	-	-

EPBMFT5-T003H **Stock No. 91493**



Info	Diameter IN	Diameter OUT	Length
	80	80	92

EPBMFT5-V002H **Stock No. 97685**



Info	Diameter IN	Diameter OUT	Length
	80	80	96

EPBMFT5-T011H **Stock No. 92630**



Info	Diameter IN	Diameter OUT	Length
	70	70	92

EPBMFT5-V005H **Stock No. 93645**



Info	Diameter IN	Diameter OUT	Length
	70	70	96

EPBMFT5-V001P **Stock No. 93006**





Info	Diameter IN	Diameter OUT	Length
	-	-	-

EPBMFT5-V006H **Stock No. 94366**



Info	Diameter IN	Diameter OUT	Length
	70	70	96

EPBMFT5-V007H **Stock No. 97257**



Info	Diameter IN	Diameter OUT	Length
	58	58	96,5

EPBMFT5-V017H **Stock No. 90311**



Info	Diameter IN	Diameter OUT	Length
	70	70	97

EPBMFT5-V008H **Stock No. 93715**



Info	Diameter IN	Diameter OUT	Length
	80	80	130

EPBMFT5-V019H **Stock No. 96039**



Info	Diameter IN	Diameter OUT	Length
	80	79	130,5

EPBMFT5-V010H **Stock No. 96310**

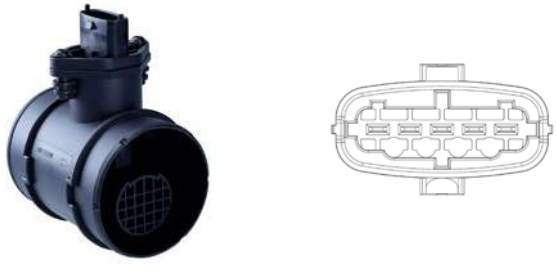

Info	Diameter IN	Diameter OUT	Length
	70	70	97

EPBMFT5-V020H **Stock No. 90244**



Info	Diameter IN	Diameter OUT	Length
	80	80	90

EPBMFT5-V013H **Stock No. 96559**



Info	Diameter IN	Diameter OUT	Length
	60	60	96

EPBMFT5-V021H **Stock No. 95278**



Info	Diameter IN	Diameter OUT	Length
	80	79	102

EPBMFT5-V022H **Stock No. 93863**



Info	Diameter IN	Diameter OUT	Length
	70	70	96

EPBMFT5-V031H **Stock No. 97525**

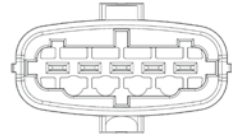
Info	Diameter IN	Diameter OUT	Length
	79	79	130

EPBMFT5-V027H **Stock No. 94616**



Info	Diameter IN	Diameter OUT	Length
	-	-	85

EPBMFT5-V033H **Stock No. 95261**



Info	Diameter IN	Diameter OUT	Length
	80	80	110

EPBMFT5-V029H **Stock No. 90502**

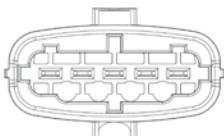
Info	Diameter IN	Diameter OUT	Length
	60	58	95

EPBMFT5-V035H **Stock No. 94119**



Info	Diameter IN	Diameter OUT	Length
	80	80	130

EPBMFT5-V030H **Stock No. 96975**

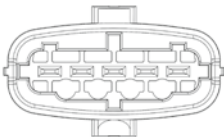
Info	Diameter IN	Diameter OUT	Length
	81	80	110

EPBMFT5-V037H **Stock No. 95360**

Info	Diameter IN	Diameter OUT	Length
	85	83	99

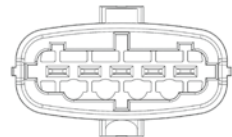
EPBMFT5-V039H **Stock No. 90466**



Info	Diameter IN	Diameter OUT	Length
	70	70	97

EPBMFT6-A026H **Stock No. 93281**



Info	Diameter IN	Diameter OUT	Length
	84	75	105

EPBMFT5-V042H **Stock No. 94057**



Info	Diameter IN	Diameter OUT	Length
	85	78	105

EPBMFT6-A044H **Stock No. 92490**

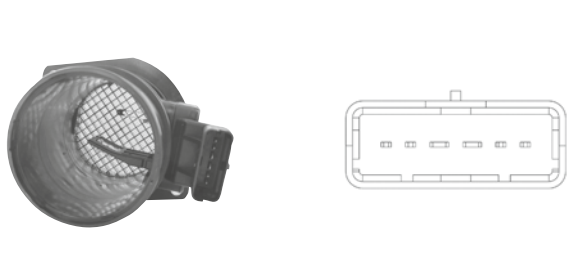

Info	Diameter IN	Diameter OUT	Length
	70	70	125

EPBMFT5-V053H **Stock No. 95935**



Info	Diameter IN	Diameter OUT	Length
	70	72	96

EPBMFT6-A049H **Stock No. 93243**



Info	Diameter IN	Diameter OUT	Length
	70	70	110

EPBMFT5-V055H **Stock No. 91808**



Info	Diameter IN	Diameter OUT	Length
	80	80	110

EPBMFT6-V046H **Stock No. 95763**



Info	Diameter IN	Diameter OUT	Length
	80	80	106

EPBMWN3-A001H **Stock No. 97106**

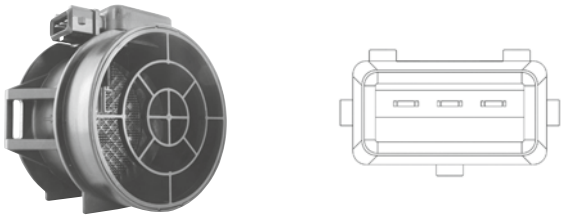

Info	Diameter IN	Diameter OUT	Length
	80,7	80	78

EPBMWN3-A017H **Stock No. 95114**



Info	Diameter IN	Diameter OUT	Length
	80	80	79

EPBMWN3-A007H **Stock No. 93658**



Info	Diameter IN	Diameter OUT	Length
	82	82	105

EPBMWN3-A021H **Stock No. 93365**



Info	Diameter IN	Diameter OUT	Length
	82	82	105

EPBMWN3-A015H **Stock No. 97380**



Info	Diameter IN	Diameter OUT	Length
	92,5	90	79,5

EPBMWN3-A023H **Stock No. 91067**



Info	Diameter IN	Diameter OUT	Length
	80	80	80

EPBMWN3-A016H **Stock No. 93176**



Info	Diameter IN	Diameter OUT	Length
	85,5	75	106

EPBMWN3-V009H **Stock No. 96875**





Info	Diameter IN	Diameter OUT	Length
	70	70	96

EPBMWN3-V031H **Stock No. 90825**



Info	Diameter IN	Diameter OUT	Length
	95	80	105,5

EPBMWN4-A019H **Stock No. 92343**

Info	Diameter IN	Diameter OUT	Length
	70	70	130

EPBMWN4-A002D **Stock No. 91111**





Info	Diameter IN	Diameter OUT	Length
	-	-	-

EPBMWN4-A024H **Stock No. 90997**



Info	Diameter IN	Diameter OUT	Length
	80	80,5	96

EPBMWN4-A011H **Stock No. 96418**

Info	Diameter IN	Diameter OUT	Length
	84	75	105

EPBMWN4-D018H **Stock No. 96313**



Info	Diameter IN	Diameter OUT	Length
	82	82	105

EPBMWN4-A012H **Stock No. 96882**

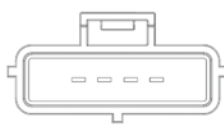
Info	Diameter IN	Diameter OUT	Length
	72	66	105

EPBMWN4-V002H **Stock No. 92462**



Info	Diameter IN	Diameter OUT	Length
	80	80	105

EPBMWN5-D003D **Stock No. 94436**



Info	Diameter IN	Diameter OUT	Length
	-	-	-

EPBMWN5-D027H **Stock No. 91976**



Info	Diameter IN	Diameter OUT	Length
	80	80	110

EPBMWN5-D003H **Stock No. 92791**



Info	Diameter IN	Diameter OUT	Length
	80	80	74

EPBMWN5-V004D **Stock No. 94183**



Info	Diameter IN	Diameter OUT	Length
	-	-	-

EPBMWN5-D006H **Stock No. 92698**



Info	Diameter IN	Diameter OUT	Length
	80	74	110

EPBMWN5-V005H **Stock No. 93291**



Info	Diameter IN	Diameter OUT	Length
	70	70	110

EPBMWN5-D014H **Stock No. 96884**



Info	Diameter IN	Diameter OUT	Length
	80	80	130

EPBMWN6-A001D **Stock No. 91743**



Info	Diameter IN	Diameter OUT	Length
	-	-	-

EPBMWN6-D029H **Stock No. 90628**



Info	Diameter IN	Diameter OUT	Length
	70	70	119,4

EPBMWT4-A001D **Stock No. 95860**



Info	Diameter IN	Diameter OUT	Length
	-	-	-

EPBMWN6-D030H **Stock No. 96504**



Info	Diameter IN	Diameter OUT	Length
	92	90	79

EPBMWT4-A008H **Stock No. 90627**

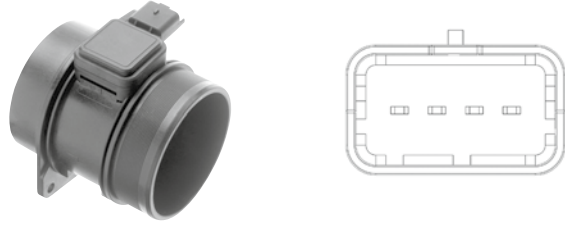

Info	Diameter IN	Diameter OUT	Length
	80	80	96

EPBMWN6-V004H **Stock No. 96070**



Info	Diameter IN	Diameter OUT	Length
	80	80	80

EPBMWT4-A009H **Stock No. 92423**

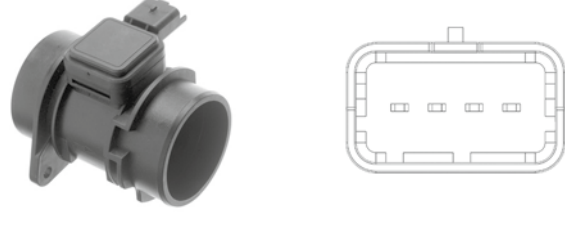

Info	Diameter IN	Diameter OUT	Length
	60	60	96

EPBMWT3-D024H **Stock No. 91171**



Info	Diameter IN	Diameter OUT	Length
	68,5	68,3	96

EPBMWT4-A011H **Stock No. 90069**



Info	Diameter IN	Diameter OUT	Length
	70	70	96

EPBMWT4-A019H Stock No. 94808



Info	Diameter IN	Diameter OUT	Length
	70	70	110,5

EPBMWT4-D014H Stock No. 93236



Info	Diameter IN	Diameter OUT	Length
	84	75	105

EPBMWT4-A022H Stock No. 93854

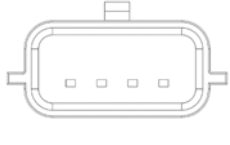
Info	Diameter IN	Diameter OUT	Length
	70	70	110

EPBMWT4-D018H Stock No. 96715



Info	Diameter IN	Diameter OUT	Length
	90	90	132

EPBMWT4-A026H Stock No. 95537



Info	Diameter IN	Diameter OUT	Length
	65,4	62,5	96,5

EPBMWT4-V002D Stock No. 95695





Info	Diameter IN	Diameter OUT	Length
	-	-	-

EPBMWT4-A028H Stock No. 91236

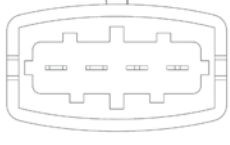

Info	Diameter IN	Diameter OUT	Length
	70	70	96

EPBMWT4-V002H Stock No. 92668

Info	Diameter IN	Diameter OUT	Length
	70	70	80

EPBMWT4-V003D **Stock No. 94395**



Info	Diameter IN	Diameter OUT	Length
	-	-	-

EPBMWT5-A005D **Stock No. 93145**

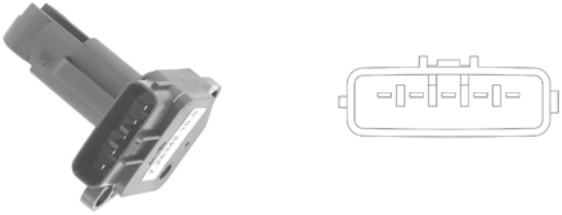

Info	Diameter IN	Diameter OUT	Length
	-	-	-

EPBMWT5-A003H **Stock No. 93842**



Info	Diameter IN	Diameter OUT	Length
	70	70,3	94,3

EPBMWT5-A005H **Stock No. 93383**



Info	Diameter IN	Diameter OUT	Length
	80	78	95,2

EPBMWT5-A004D **Stock No. 91831**



Info	Diameter IN	Diameter OUT	Length
	-	-	-

EPBMWT5-A006D **Stock No. 91258**

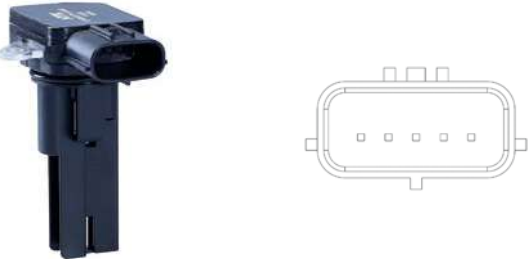

Info	Diameter IN	Diameter OUT	Length
	-	-	-

EPBMWT5-A004H **Stock No. 91200**



Info	Diameter IN	Diameter OUT	Length
	70	70	95,5

EPBMWT5-A014D **Stock No. 90205**



Info	Diameter IN	Diameter OUT	Length
	-	-	-

EPBMWT5-A025H Stock No. 93777



Info	Diameter IN	Diameter OUT	Length
	92	78	105

EPBMWT5-D020H Stock No. 97934





Info	Diameter IN	Diameter OUT	Length
	70,5	70	76

EPBMWT5-A027H Stock No. 96756

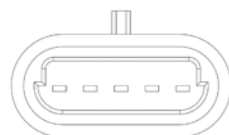

Info	Diameter IN	Diameter OUT	Length
	80	80	110,5

EPBMWT5-V010H Stock No. 93933

Info	Diameter IN	Diameter OUT	Length
	60	60	106,5

EPBMWT5-D012H Stock No. 91007

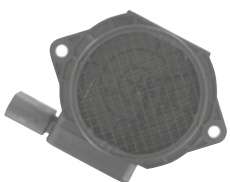
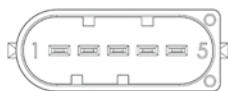

Info	Diameter IN	Diameter OUT	Length
	70	70	76

EPBMWT5-V012D Stock No. 95034

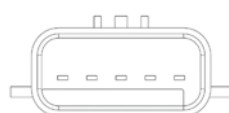
Info	Diameter IN	Diameter OUT	Length
	-	-	-

EPBMWT5-D017H Stock No. 94348

Info	Diameter IN	Diameter OUT	Length
	70	70	85

EPBMWT5-V013D Stock No. 92480



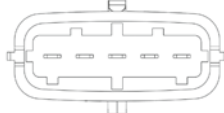

Info	Diameter IN	Diameter OUT	Length
	-	-	-

EPBMWT5-V021H **Stock No. 97091**

Info	Diameter IN	Diameter OUT	Length
	70	70	80

EPBMWT6-A007H **Stock No. 93605**

Info	Diameter IN	Diameter OUT	Length
	70	70	110,5

EPBMWT5-V023H **Stock No. 95103**





Info	Diameter IN	Diameter OUT	Length
	70	70	90

EPBMWT6-V013H **Stock No. 92412**



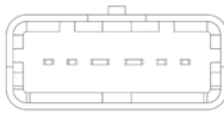

Info	Diameter IN	Diameter OUT	Length
	60	60	110,5

EPBMWT6-A001H **Stock No. 90144**

Info	Diameter IN	Diameter OUT	Length
	69,8	69,8	109

EPBMWT6-A006H **Stock No. 94034**

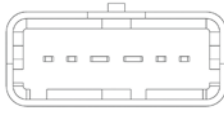
Info	Diameter IN	Diameter OUT	Length
	60	60	96



CROSS REFERENCE GUIDE

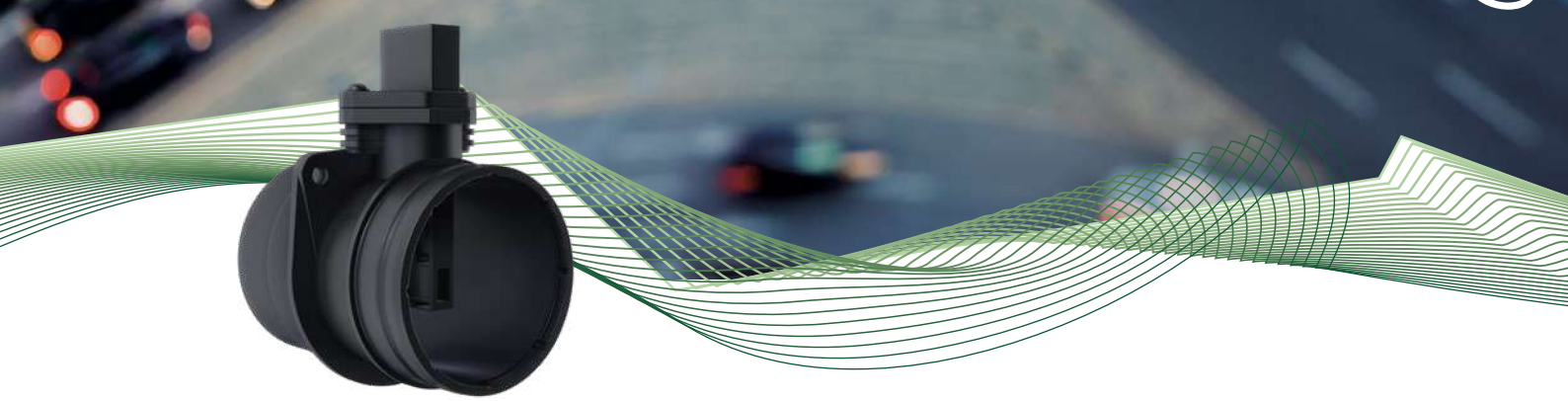

VEHICLE
ELECTRONICS

ALFA ROMEO	→ NTK	Stock
11140004	EPBMFN4-V010H	97588
46444287	EPBMFT5-V008H	93715
46824377	EPBMFT5-V035H	94119
46824377	EPBMFT5-V001P	93006
51782033	EPBMFN4-V026H	94497
51782034	EPBMFN4-V017H	96226
51782035	EPBMFT4-V004H	90957
51792729	EPBMFT4-V061H	94528
51827033	EPBMFN4-V020H	90971
51831050	EPBMFT4-V004H	90957
55183650	EPBMFN4-V017H	96226
55183651	EPBMFN4-V010H	97588
55187722	EPBMFT5-V020H	90244
55190587	EPBMFN4-V020H	90971
55243210	EPBMFT4-V061H	94528
55350048	EPBMFN4-V026H	94497
55350048	EPBMFN4-V010H	97588
60663029	EPBMFT5-V008H	93715
60802037	EPBMFT5-V035H	94119
60815616	EPBMFT5-V008H	93715
71787992	EPBMFN4-V026H	94497
71787995	EPBMFT5-V035H	94119
71787998	EPBMFT5-V035H	94119
71787999	EPBMFT5-V008H	93715
71788002	EPBMFT5-V008H	93715
71788742	EPBMFT5-V020H	90244
71789478	EPBMFN4-V020H	90971
71789479	EPBMFN4-V020H	90971
71789484	EPBMFN4-V017H	96226
71789485	EPBMFN4-V017H	96226
71793250	EPBMFN4-V017H	96226
71794087	EPBMFN4-V020H	90971
71794484	EPBMFN4-V026H	94497
71794487	EPBMFT4-V004H	90957
71795057	EPBMFT4-V004H	90957
9658127480	EPBMWT4-A001D	95860
AUDI	→ NTK	Stock
058133471	EPBMWN3-A016H	93176
78133471	EPBMWN3-A007H	93658
420133471	EPBMWT5-V013D	92480
03G906461C	EPBMFN5-D001H	95207
03H906461	EPBMFT5-D040H	97032
03L906461A	EPBMFN4-V008H	95035
057906461A	EPBMFT5-D014H	95484
057906461AX	EPBMFT5-D014H	95484
058133471X	EPBMWN3-A016H	93176
059906461D	EPBMWN5-D014H	96884
059906461DV	EPBMWN5-D014H	96884
059906461DX	EPBMWN5-D014H	96884
059906461G	EPBMWN5-D014H	96884
059906461GV	EPBMWN5-D014H	96884
059906461GX	EPBMWN5-D014H	96884

AUDI	→ NTK	Stock
059906461K	EPBMFN5-D033H	93804
059906461M	EPBMWN5-D014H	96884
059906461MV	EPBMWN5-D014H	96884
059906461MX	EPBMWN5-D014H	96884
059906461N	EPBMWT5-A025H	93777
06A906461B	EPBMWT4-D014H	93236
06A906461BV	EPBMWT4-D014H	93236
06A906461BX	EPBMWT4-D014H	93236
06A906461M	EPBMFN5-D021H	90140
06A906461MX	EPBMFN5-D021H	90140
06D906461	EPBMWN5-D006H	92698
06F906461A	EPBMWN5-D003D	94436
06J906461B	EPBMWN5-D027H	91976
06J906461D	EPBMWT5-A027H	96756
071906461B	EPBMFT5-D024H	93373
071906461BX	EPBMFT5-D024H	93373
078133471A	EPBMWN3-A007H	93658
078133471AV	EPBMWN3-A007H	93658
078133471AX	EPBMWN3-A007H	93658
07D906461	EPBMFT5-D038H	96961
07D906461X	EPBMFT5-D038H	96961
3L7Z12B579AA	EPBMWN3-A016H	93176
581334710V	EPBMWN3-A016H	93176
59906461F	EPBMWN5-D014H	96884
BENTLEY	→ NTK	Stock
07D906461	EPBMFT5-D038H	96961
07V906461	EPBMFT5-D040H	97032
BMW	→ NTK	Stock
1432356	EPBMWN3-A001H	97106
2246084	EPBMFN6-R030H	90274
7566989	EPBMFT5-D034H	96295
7788743	EPBMFN4-D004H	91534
7788744	EPBMFN4-D011H	94586
7793633	EPBMFN4-D009H	96113
7801951	EPBMFN4-D009H	96113
7805415	EPBMFN4-D009H	96113
8509724	EPBMFN4-D004H	91534
8509725	EPBMFN4-D009H	96113
13621432356	EPBMWN3-A001H	97106
13621433565	EPBMFT5-D012H	93496
13621433567	EPBMFT5-D060H	95878
13621438687	EPBMFT5-D016H	95579
13621438871	EPBMWN3-A015H	97380
13622246084	EPBMFN6-R030H	90274
13622247074	EPBMFT5-D023H	93770
13627513956	EPBMWN6-D030H	96504
13627513957	EPBMWN6-V004H	96070
13627524136	EPBMFT5-D056H	90827
13627531702	EPBMFT5-D034H	96295
13627542418	EPBMFN5-A038H	93095
13627566983	EPBMWN6-D030H	96504
13627566984	EPBMWN6-V004H	96070

BMW	→ NTK	Stock
13627566986	EPBMFT5-D003P	96835
13627566986	EPBMFT5-D016H	95579
13627566988	EPBMFT5-D056H	90827
13627566989	EPBMFT5-D034H	96295
13627567451	EPBMWN3-A015H	97380
13627787076	EPBMFT5-D023H	93770
13627788743	EPBMFN4-D004H	91534
13627788744	EPBMFN4-D011H	94586
13627793633	EPBMFN4-D009H	96113
13627801951	EPBMFN4-D009H	96113
13627805415	EPBMFN4-D009H	96113
13628506409	EPBMFT5-A051H	90866
13628509724	EPBMFN4-D004H	91534
13628509725	EPBMFN4-D009H	96113
13712247002	EPBMFT5-D003P	96835
13712247002	EPBMFT5-D023H	93770
13712247592	EPBMFT5-V001P	93006
13712247592	EPBMFT5-D015H	92304
CADILLAC	→ NTK	Stock
55190587	EPBMFN4-V020H	90971
93178243	EPBMFN4-V026H	94497
CHEVROLET	→ NTK	Stock
55350048	EPBMFN4-V026H	94497
55561912	EPBMFT5-T011H	92630
55562426	EPBMFT5-T003H	91493
96806111	EPBMFN4-V017H	96226
CHRYSLER	→ NTK	Stock
51792729	EPBMFT4-V061H	94528
51831050	EPBMFT4-V004H	90957
05033320AA	EPBMFN5-D002P	91609
05033320AA	EPBMFN5-D047H	91140
5033109AB	EPBMFT5-V053H	95935
5033320AA	EPBMFN5-D047H	91140
53013673AA	EPBMFN4-D014H	92888
K05033109AB	EPBMFT5-V053H	95935
K53013673AA	EPBMFN4-D014H	92888
CITROËN	→ NTK	Stock
163675	EPBMFT4-V004H	90957
9645948780	EPBMWT4-A011H	90069
9647144080	EPBMWT4-A009H	92423
9674958880	EPBMWT4-V003D	94395
1192CE	EPBMFN4-V020H	90971
1192CK	EPBMFT4-V061H	94528
1192W5	EPBMFT5-V008H	93715
1192Y9	EPBMFN4-V020H	90971
1920GG	EPBMWT4-A009H	92423
1920GN	EPBMWT4-A011H	90069
CITROËN/PEUGEOT	→ NTK	Stock
9628336380	EPBMWT5-A004H	91200
9629471080	EPBMWT5-A003H	93842
9632215280	EPBMWT5-A005H	93383
9642212180	EPBMWT6-A006H	94034

CITROËN/PEUGEOT	→ NTK	Stock
9645945780	EPBMWT4-A008H	90627
9645948980	EPBMWT4-A008H	90627
9650010780	EPBMFT5-A001H	93740
9657127480	EPBMWT4-A001D	95860
9657533680	EPBMWT6-A006H	94034
9662635680	EPBMWT4-A028H	91236
9681917980	EPBMWN4-A024H	90997
9683282980	EPBMWT4-A026H	95537
00001920AG	EPBMWT5-A005H	93383
19207S	EPBMWT5-A003H	93842
19207S	EPBMWT5-A003H	93842
19208Q	EPBMWT5-A004H	91200
1920AG	EPBMWT5-A005H	93383
1920EK	EPBMWT6-A006H	94034
1920GV	EPBMFT5-A001H	93740
1920HH	EPBMWT4-A008H	90627
1920KQ	EPBMWT4-A001D	95860
1920QV	EPBMWT4-A028H	91236
1920RA	EPBMWT4-A026H	95537
DACIA	→ NTK	Stock
8200280056	EPBMWT6-V013H	92412
8200651315	EPBMWT4-A019H	94808
DAEWOO	→ NTK	Stock
96806111	EPBMFN4-V017H	96226
FERRARI	→ NTK	Stock
171707	EPBMFT5-V031H	97525
FIAT	→ NTK	Stock
11140004	EPBMFN4-V010H	97588
46444287	EPBMFT5-V008H	93715
46447503	EPBMFT5-V001P	93006
46447503	EPBMFT5-V017H	90311
46447508	EPBMFT5-V001P	93006
46447508	EPBMFT5-V017H	90311
46469917	EPBMFT5-V001P	93006
46469917	EPBMFT5-V007H	97257
46472182	EPBMFT5-V001P	93006
46472182	EPBMFT5-V017H	90311
46533308	EPBMFT5-V001P	93006
46533308	EPBMFT5-V039H	90466
46541253	EPBMFT5-V001P	93006
46541253	EPBMFT5-V017H	90311
46559804	EPBMFT5-V001P	93006
46784582	EPBMFT5-V001P	93006
46784582	EPBMFT5-V029H	90502
46811122	EPBMFT5-V001P	93006
46811122	EPBMFT5-V039H	90466
46811312	EPBMFT5-V001P	93006
46824377	EPBMFT5-V035H	94119
46824377	EPBMFT5-V001P	93006
51774531	EPBMFT5-V001P	93006
51774531	EPBMFT5-V029H	90502
51782033	EPBMFN4-V026H	94497

FIAT	→ NTK	Stock
51782033	EPBMFN4-V010H	97588
51782034	EPBMFN4-V017H	96226
51782035	EPBMFT4-V004H	90957
51792729	EPBMFT4-V061H	94528
51827033	EPBMFN4-V020H	90971
51830257	EPBMFT4-V061H	94528
51831050	EPBMFT4-V004H	90957
55183650	EPBMFN4-V017H	96226
55183651	EPBMFN4-V010H	97588
55187718	EPBMFT5-V001P	93006
55187718	EPBMFT5-V010H	96310
55190587	EPBMFN4-V020H	90971
55193048	EPBMFT5-V001P	93006
55206756	EPBMFN4-V010H	97588
55350048	EPBMFN4-V026H	94497
55350048	EPBMFN4-V010H	97588
55353813	EPBMFT4-V048H	95493
60663029	EPBMFT5-V019H	96039
60802028	EPBMFT5-V001P	93006
60802037	EPBMFT5-V035H	94119
60814852	EPBMFT5-V001P	93006
60814852	EPBMFT5-V017H	90311
60815616	EPBMFT5-V008H	93715
60816137	EPBMFT5-V001P	93006
71742070	EPBMWT5-A014D	90205
71742070	EPBMWT5-A014D	90205
71743972	EPBMFN4-V026H	94497
71750589	EPBMFT4-V004H	90957
71789478	EPBMFN4-V020H	90971
71789484	EPBMFN4-V017H	96226
71789485	EPBMFN4-V017H	96226
71792016	EPBMWT5-A014D	90205
71792016	EPBMWT5-A014D	90205
71792019	EPBMFN4-V026H	94497
71792021	EPBMFN4-V026H	94497
71793250	EPBMFN4-V017H	96226
71794087	EPBMFN4-V020H	90971
71794484	EPBMFN4-V026H	94497
71794487	EPBMFT4-V004H	90957
71794496	EPBMFT4-V061H	94528
71795057	EPBMFT4-V004H	90957
71795145	EPBMFT4-V061H	94528
71795146	EPBMFT4-V061H	94528
1324369080	EPBMFT5-V008H	93715
9632215280	EPBMWT5-A005H	93383
9657127480	EPBMWT4-A001D	95860
K68083242AA	EPBMFT4-V004H	90957
FORD	→ NTK	Stock
1003751	EPBMWN6-D029H	90628
1004581	EPBMWN4-A012H	96882
1051277	EPBMFT6-A026H	93281
1051396	EPBMFN5-D002P	91609

FORD	→ NTK	Stock
1051396	EPBMFN5-D005H	92204
1054419	EPBMFT6-A026H	93281
1054420	EPBMFT6-A026H	93281
1112131	EPBMFT5-D024H	93373
1112131	EPBMFT5-D005P	90557
1129009	EPBMWN4-A002D	91111
1148059	EPBMWT6-A006H	94034
1209109	EPBMFN5-D002P	91609
1209109	EPBMFN5-D002H	91692
1223521	EPBMFT5-V033H	95261
1232096	EPBMFT5-A001H	93740
1232944	EPBMWT4-A008H	90627
1255117	EPBMFT5-A001H	93740
1303898	EPBMWT4-A008H	90627
1333637	EPBMWT4-A009H	92423
1344951	EPBMFN5-D005H	92204
1348614	EPBMWT6-A006H	94034
1348615	EPBMWT4-A009H	92423
1352840	EPBMWN4-V002H	92462
1365122	EPBMWN4-V002H	92462
1367827	EPBMFT5-V021H	95278
1376235	EPBMWT4-A001D	95860
1384275	EPBMFN5-D002P	91609
1384275	EPBMFN5-D005H	92204
1419677	EPBMWT4-A011H	90069
1428448	EPBMFN5-D002P	91609
1428448	EPBMFN5-D005H	92204
1444420	EPBMWT4-V002D	95695
1448816	EPBMWT5-A014D	90205
1448816	EPBMWT5-A014D	90205
1480570	EPBMWT4-V002D	95695
1516668	EPBMWT4-V003D	94395
1542478	EPBMFN4-V017H	96226
1729032	EPBMFT4-V004H	90957
1845928	EPBMFT5-D005P	90557
4399275	EPBMWT5-A014D	90205
4399275	EPBMWT5-A014D	90205
4505196	EPBMWT5-A014D	90205
4505196	EPBMWT5-A014D	90205
4515688	EPBMWN6-A001D	91743
6848047	EPBMWN4-A011H	96418
1X4312B579AB	EPBMWT5-A014D	90205
1X4312B579AB	EPBMWT5-A014D	90205
2S6Q12B579AA	EPBMWT6-A006H	94034
2S6Q12B579AB	EPBMWT6-A006H	94034
2S6Q12B579BA	EPBMWT4-A009H	92423
2S6Q12B579BB	EPBMWT4-A009H	92423
2S7A12B579CA	EPBMFT5-V033H	95261
3L3A12B579BA	EPBMWN6-A001D	91743
3M2112B529AA	EPBMFN5-D002P	91609
3M2112B529AA	EPBMFN5-D002H	91692
3M5A12B579AA	EPBMWT4-A008H	90627

FORD	→ NTK	Stock
3M5A12B579AB	EPBMWT4-A008H	90627
3M5A12B579BA	EPBMFT5-A001H	93740
3M5A12B579BB	EPBMFT5-A001H	93740
4H229G820AA	EPBMWT4-D018H	96715
4H2Q12B579AC	EPBMWT4-D018H	96715
4M5112B579CC	EPBMWN4-V002H	92462
4R8Q12B579AC	EPBMWT4-A011H	90069
6C1112B579AA	EPBMWT4-A001D	95860
6G9N9G760AA	EPBMFT5-V001P	93006
6G9N9G760AA	EPBMFT5-V021H	95278
7M5112B579BB	EPBMWT4-V002D	95695
8V2112B579AA	EPBMWT4-V003D	94395
93BB12B579BA	EPBMWN4-A011H	96418
95VW12B529BA	EPBMWN6-D029H	90628
95VW12B529BB	EPBMFN5-D005H	92204
95VW12B529BC	EPBMFN5-D002P	91609
95VW12B529BC	EPBMFN5-D005H	92204
96FB12B579EB	EPBMWN4-A012H	96882
98AB12B579B1B	EPBMFT6-A026H	93281
98AB12B579B2B	EPBMFT6-A026H	93281
98AB12B579B3B	EPBMFT6-A026H	93281
9S5112B579AA	EPBMFN4-V017H	96226
BS5112B579AA	EPBMFT4-V004H	90957
RM95VW12B529BB	EPBMFN5-D005H	92204
RM95VW12B529BC	EPBMFN5-D005H	92204
XM3412B579DA	EPBMWT5-A014D	90205
XM3412B579DA	EPBMWT5-A014D	90205
XS7F12B579AA	EPBMWN4-A002D	91111
YM2112B529BA	EPBMFT5-D024H	93373
YM2112B529BA	EPBMFT5-D005P	90557
FORD USA	→ NTK	Stock
4505196	EPBMWT5-A014D	90205
4505196	EPBMWT5-A014D	90205
XM3412B579DA	EPBMWT5-A014D	90205
XM3412B579DA	EPBMWT5-A014D	90205
FPT	→ NTK	Stock
55206758	EPBMFT4-V004H	90957
55219169	EPBMFN4-V020H	90971
55220331	EPBMFT4-V061H	94528
55220715	EPBMFT4-V004H	90957
FUSO (MITSUBISHI)	→ NTK	Stock
ME422096	EPBMFT4-V061H	94528
ME422856	EPBMFT4-V061H	94528
GENERAL MOTORS	→ NTK	Stock
836569	EPBMWN4-A019H	92343
836583	EPBMWT4-V002H	92668
836584	EPBMFT5-V007H	97257
836588	EPBMFT5-V017H	90311
836592	EPBMFT5-V017H	90311
836629	EPBMFT5-V017H	90311
836630	EPBMFT5-V019H	96039
836645	EPBMFT5-V017H	90311

GENERAL MOTORS	→ NTK	Stock
1882019	EPBMFT5-V001P	93006
9110733	EPBMWT6-A001H	90144
9128919	EPBMFN4-A035H	97899
9193149	EPBMFT5-V001P	93006
9193149	EPBMFT5-V007H	97257
9195729	EPBMFT5-V001P	93006
9195729	EPBMFT5-V017H	90311
9201425	EPBMFT5-V001P	93006
9201425	EPBMFT5-V017H	90311
9201701	EPBMFT6-A044H	92490
9227760	EPBMFT5-V001P	93006
9227760	EPBMFT5-V007H	97257
9470640	EPBMFT5-V021H	95278
12671610	EPBMFT5-T011H	92630
12671611	EPBMFT5-T003H	91493
12671616	EPBMFT5-T001D	94095
13262124	EPBMFT5-T011H	92630
13301682	EPBMFT5-T001D	94095
24404016	EPBMWT5-V021H	97091
24414665	EPBMFT5-V001P	93006
24414665	EPBMFT5-V017H	90311
24420614	EPBMFT5-V001P	93006
24420614	EPBMFT5-V007H	97257
24437502	EPBMFT5-V010H	96310
24437503	EPBMFT5-V001P	93006
24437503	EPBMFT5-V019H	96039
24439252	EPBMFT5-V001P	93006
24439252	EPBMFT5-V010H	96310
25358054	EPBMWT5-V010H	93933
55190587	EPBMFN4-V020H	90971
55350045	EPBMFT5-V001P	93006
55350045	EPBMFT5-V029H	90502
55350046	EPBMWN3-V009H	96875
55350047	EPBMFT5-V022H	93863
55350048	EPBMFN4-V026H	94497
55350048	EPBMFN4-V010H	97588
55351974	EPBMFT5-V001P	93006
55351974	EPBMFT5-V017H	90311
55353813	EPBMFT4-V048H	95493
55559313	EPBMFT5-V001P	93006
55559313	EPBMFT5-V017H	90311
55561301	EPBMFT5-V006H	94366
55561304	EPBMFN5-V001D	95368
55561912	EPBMFT5-T011H	92630
55562426	EPBMFT5-T003H	91493
90411957	EPBMWN4-A019H	92343
90411957	EPBMWN4-A019H	92343
90423761	EPBMFT5-V001P	93006
90423761	EPBMFT5-V017H	90311
90528813	EPBMFN6-R030H	90274
90529673	EPBMFT5-V001P	93006
90529673	EPBMFT5-V007H	97257

GENERAL MOTORS →	NTK	Stock
90530463	EPBMWT4-V002H	92668
90530767	EPBMFT5-V001P	93006
90530767	EPBMFT5-V017H	90311
90543282	EPBMFT5-V001P	93006
90543282	EPBMFT5-V007H	97257
90543463	EPBMFT5-V001P	93006
90543463	EPBMFT5-V017H	90311
93171355	EPBMFT5-V001P	93006
93171355	EPBMFT5-V017H	90311
93171356	EPBMFT5-V001P	93006
93171356	EPBMFT5-V017H	90311
93171527	EPBMFT5-V010H	96310
93171627	EPBMFT5-V010H	96310
93171760	EPBMFT5-V008H	93715
93171760	EPBMFT5-V001P	93006
93172747	EPBMFT5-V035H	94119
93173727	EPBMFT5-V001P	93006
93173727	EPBMFT5-V019H	96039
93174129	EPBMFT5-V001P	93006
93177718	EPBMFT5-V001P	93006
93177718	EPBMFT5-V010H	96310
93178050	EPBMFT5-V022H	93863
93178243	EPBMFN4-V026H	94497
93178243	EPBMFN4-V010H	97588
93178244	EPBMFT5-V001P	93006
93178244	EPBMFT5-V029H	90502
93179927	EPBMFT5-V001P	93006
93179927	EPBMFT5-V007H	97257
93180922	EPBMFT5-V001P	93006
93180922	EPBMFT5-V017H	90311
93180992	EPBMFT5-V001P	93006
93180992	EPBMFT5-V017H	90311
93181894	EPBMFT5-V020H	90244
93185443	EPBMFT4-V048H	95493
93188724	EPBMFT5-V006H	94366
93189955	EPBMFN5-V001D	95368
93193470	EPBMFN4-V031H	96741
93328218	EPBMFT5-V001P	93006
93856812	EPBMWT6-A007H	93605
93861383	EPBMWT6-A007H	93605
93863896	EPBMWT4-A019H	94808
95510006	EPBMFT4-V004H	90957
95510015	EPBMFT4-V004H	90957
95513367	EPBMFN4-V017H	96226
96184230	EPBMWN4-A019H	92343
96806111	EPBMFN4-V017H	96226
97253456	EPBMFT5-V035H	94119
634915771	EPBMWN3-V009H	96875
A116E6059F	EPBMFT5-V017H	90311
HITACHI →	NTK	Stock
135038	EPBMWT5-A014D	90205
135038	EPBMWT5-A014D	90205

HITACHI	→ NTK	Stock
135039	EPBMWT5-A014D	90205
135039	EPBMWT5-A014D	90205
135041	EPBMWT5-A014D	90205
135041	EPBMWT5-A014D	90205
135067	EPBMWT5-A014D	90205
135067	EPBMWT5-A014D	90205
135097	EPBMFN4-D011H	94586
135098	EPBMFT5-V008H	93715
138348	EPBMFT4-V004H	90957
138349	EPBMFN5-D001H	95207
138366	EPBMFT5-D024H	93373
138993	EPBMFT5-D034H	96295
138995	EPBMFT5-D018H	96224
138998	EPBMFT5-V020H	90244
138999	EPBMFT5-V020H	90244
2505038	EPBMWT5-A014D	90205
2505038	EPBMWT5-A014D	90205
2505039	EPBMWT5-A014D	90205
2505039	EPBMWT5-A014D	90205
2505041	EPBMWT5-A014D	90205
2505041	EPBMWT5-A014D	90205
2505067	EPBMWT5-A014D	90205
2505067	EPBMWT5-A014D	90205
2505086	EPBMFN5-V005D	90496
2505097	EPBMFN4-D011H	94586
2505098	EPBMFT5-V008H	93715
AFH5020	EPBMWN4-A012H	96882
AFH6002A	EPBMWN4-A011H	96418
AFH6010B	EPBMWN3-A016H	93176
AFH6010C	EPBMWT4-D014H	93236
AFH6013	EPBMFT6-A026H	93281
AFH6022	EPBMWT5-V023H	95103
AFH6024	EPBMWN5-V005H	93291
AFH6028	EPBMWN5-D006H	92698
AFH6029	EPBMWN3-V009H	96875
AFH6034	EPBMWN5-D027H	91976
AFH60M16	EPBMWN4-A002D	91111
AFH60M19	EPBMWN6-A001D	91743
AFH60M21	EPBMWN6-A001D	91743
AFH60M27	EPBMWN5-D003D	94436
AFH7008B	EPBMWN3-A007H	93658
AFH7008C	EPBMWN3-A021H	93365
AFH7008D	EPBMWN4-D018H	96313
AFH7014	EPBMWN3-V031H	90825
AFH7025C	EPBMWN5-D014H	96884
AFH7025G	EPBMWN5-D014H	96884
AFH7046	EPBMFN5-D033H	93804
AFH7051	EPBMFN5-V005D	90496
AFH7055	EPBMWN4-V002H	92462
AFH7088	EPBMWN4-A024H	90997
AFH70M23	EPBMWT5-A004D	91831
AFH70M38	EPBMFN5-V005D	90496

HITACHI	→ NTK	Stock
AFH70M38B	EPBMFN5-V005D	90496
AFH70M38S	EPBMFN5-V005D	90496
AFH70M54	EPBMWT4-A001D	95860
AFH70M62A	EPBMWN5-V004D	94183
AFH70M77	EPBMWT5-V012D	95034
AFH70M79	EPBMWT4-V002D	95695
AFH70M83	EPBMWT4-V003D	94395
MAF0010	EPBMWN5-D006H	92698
MAF0020	EPBMWN3-A007H	93658
MAF0021	EPBMWN3-A021H	93365
MAF0044	EPBMWN3-A016H	93176
MAF0051	EPBMWN5-D027H	91976
MAF0052	EPBMWN5-D003D	94436
MAF0115	EPBMWT4-V003D	94395
U08001AFS	EPBMFN5-V005D	90496
U09006AFS	EPBMWN5-V005H	93291
U09007AFS	EPBMWN3-A007H	93658
U09008AFS	EPBMWN3-A021H	93365
U09012AFS	EPBMWT4-D014H	93236
U09013AFS	EPBMWN5-D014H	96884
U09015AFS	EPBMWN4-A011H	96418
U09019AFS	EPBMWN3-A016H	93176
U09021AFS	EPBMFN5-D033H	93804
U09022AFS	EPBMWN4-A012H	96882
U11H01AFS	EPBMWN5-V004D	94183
U11OP01AFS	EPBMWN3-V009H	96875
HONDA	→ NTK	Stock
16400PDDX00	EPBMFT5-V031H	97525
16400PDDX00	EPBMFT5-V001P	93006
16400PLZE01	EPBMFT5-V001P	93006
16400PLZE01	EPBMFT5-V039H	90466
16400PLZE011	EPBMFT5-V001P	93006
16400PLZE011	EPBMFT5-V039H	90466
37980RMAE01	EPBMWN5-V004D	94183
HYUNDAI	→ NTK	Stock
2816422601	EPBMFT5-V013H	96559
2816422610	EPBMFT5-V013H	96559
2816423700	EPBMWT5-D012H	91007
2816423720	EPBMWT5-D012H	91007
2816427000	EPBMFT5-V017H	90311
2816427050	EPBMFT5-V053H	95935
2816427500	EPBMFT5-V029H	90502
2816427800	EPBMFT5-V002H	97685
2816427900	EPBMFT5-V010H	96310
2816437100	EPBMWN3-A001H	97106
2816437200	EPBMWN3-A017H	95114
2816438080	EPBMFT5-V017H	90311
2816438200	EPBMFT5-V017H	90311
2816438210	EPBMFT5-V017H	90311
3932052000	EPBMFT5-V002D	97692
281642A401	EPBMFT5-V005H	93645
281642A500	EPBMFT5-V005H	93645

HYUNDAI	→ NTK	Stock
281644A000	EPBMFT5-V001P	93006
281644A000	EPBMFT5-V001P	93006
281644A900	EPBMFT5-V002H	97685
ISUZU	→ NTK	Stock
97253456	EPBMFT5-V035H	94119
8972534560	EPBMFT5-V035H	94119
8972534561	EPBMFT5-V035H	94119
IVECO	→ NTK	Stock
55220331	EPBMFT4-V061H	94528
69503670	EPBMFN4-V020H	90971
0000069503670	EPBMFN4-V020H	90971
500026735	EPBMFN4-V020H	90971
500332364	EPBMFT5-V008H	93715
0000500332364	EPBMFT5-V008H	93715
504051082	EPBMFT5-V008H	93715
0000504051082	EPBMFT5-V008H	93715
504136035	EPBMFN4-V020H	90971
0000504136035	EPBMFN4-V020H	90971
504301164	EPBMFT4-V061H	94528
JAGUAR	→ NTK	Stock
1X4312B579AA	EPBMWT5-A005D	93145
1X4312B579AB	EPBMWT5-A005D	93145
C2C12919	EPBMWT4-A011H	90069
C2S2670	EPBMWT5-A005D	93145
C2S2670	EPBMWT5-A014D	90205
C2S2670	EPBMWT5-A014D	90205
C2S26978	EPBMWN4-A002D	91111
JEEP	→ NTK	Stock
51831050	EPBMFT4-V004H	90957
71795057	EPBMFT4-V004H	90957
53013009AA	EPBMFT5-V033H	95261
53013673AA	EPBMFN4-D014H	92888
68167871AA	EPBMFT4-V004H	90957
K53013009AA	EPBMFT5-V033H	95261
K68167871AA	EPBMFT4-V004H	90957
KIA	→ NTK	Stock
2816423720	EPBMWT5-D012H	91007
2816427050	EPBMFT5-V053H	95935
2816427800	EPBMFT5-V002H	97685
0K01113210B	EPBMFN4-A035H	97899
0K08013210	EPBMFN4-A035H	97899
0K0AA13210	EPBMFT5-V033H	95261
0K32A13210	EPBMFN3-A028H	94128
281642A401	EPBMFT5-V005H	93645
281642A500	EPBMFT5-V005H	93645
281644A000	EPBMFT5-V001P	93006
281644A000	EPBMFT5-V001P	93006
281644A000	EPBMFT5-V030H	96975
281644A900	EPBMFT5-V002H	97685
LADA	→ NTK	Stock
210831130010	EPBMFT5-V039H	90466
21083113001010	EPBMFT5-V039H	90466

LADA	→ NTK	Stock
21083113001020	EPBMFT5-V039H	90466
LANCIA	→ NTK	Stock
11140004	EPBMFN4-V010H	97588
46533308	EPBMFT5-V001P	93006
46824377	EPBMFT5-V035H	94119
46824377	EPBMFT5-V001P	93006
51782034	EPBMFN4-V017H	96226
51782035	EPBMFT4-V004H	90957
51792729	EPBMFT4-V061H	94528
51827033	EPBMFN4-V020H	90971
51831050	EPBMFT4-V004H	90957
55183650	EPBMFN4-V017H	96226
55183651	EPBMFN4-V010H	97588
55350048	EPBMFN4-V026H	94497
55350048	EPBMFN4-V010H	97588
60802037	EPBMFT5-V035H	94119
60815616	EPBMFT5-V008H	93715
71789484	EPBMFN4-V017H	96226
71789485	EPBMFN4-V017H	96226
71793250	EPBMFN4-V017H	96226
71794487	EPBMFT4-V004H	90957
71795057	EPBMFT4-V004H	90957
LAND ROVER	→ NTK	Stock
1X4312B579AA	EPBMWT5-A005D	93145
AMR5707	EPBMFN5-V043H	93581
LR002141	EPBMWT5-A014D	90205
LR002141	EPBMWT5-A014D	90205
LR019830	EPBMWT4-V003D	94395
MHK000230	EPBMFT5-D060H	95878
MHK000280	EPBMFT5-D023H	93770
MHK100620	EPBMWN3-A001H	97106
MHK100850	EPBMFN5-V043H	93581
MHK101130L	EPBMFT5-V001P	93006
MHK101130L	EPBMFT5-D015H	92304
MHK501040	EPBMWT4-A001D	95860
PHF000140	EPBMWT5-A014D	90205
PHF000140	EPBMWT5-A014D	90205
PHF000140	EPBMWT5-A005D	93145
PHF500090	EPBMWT4-A011H	90069
PHF500100	EPBMWT4-D018H	96715
PHF500101	EPBMWT4-D018H	96715
LEXUS	→ NTK	Stock
2220422010	EPBMWT5-A014D	90205
2220422010	EPBMWT5-A014D	90205
2220428010	EPBMFT5-V002D	97692
2220430010	EPBMWT5-A014D	90205
2220430010	EPBMWT5-A014D	90205
2220437010	EPBMFT5-V002D	97692
222040D030	EPBMWT5-A014D	90205
222040D030	EPBMWT5-A014D	90205
222040P020	EPBMFT5-V002D	97692
222040T020	EPBMFT5-V002D	97692

LEXUS	→ NTK	Stock
222040T030	EPBMFT5-V002D	97692
222040T040	EPBMFT5-V002D	97692
222040V010	EPBMFT5-V002D	97692
222040V020	EPBMFT5-V002D	97692
MAN	→ NTK	Stock
65274210006	EPBMFN4-V008H	95035
03L906461A	EPBMFN4-V008H	95035
MAZDA	→ NTK	Stock
1974002010	EPBMWT5-A005D	93145
L32113215	EPBMWT5-A005D	93145
WLS113215	EPBMWT5-A005D	93145
WLS113215	EPBMWT5-A014D	90205
WLS113215	EPBMWT5-A014D	90205
WLS113215A	EPBMWT5-A014D	90205
WLS113215A	EPBMWT5-A014D	90205
Y40413215	EPBMWT4-A009H	92423
Y60113215	EPBMFT5-A001H	93740
ZL0113215	EPBMWT5-A005D	93145
ZL0113215	EPBMWT5-A014D	90205
ZL0113215	EPBMWT5-A014D	90205
ZL1Y13215	EPBMWT5-A005D	93145
ZLY113215	EPBMWT5-A005D	93145
ZLY113215	EPBMWT5-A014D	90205
ZLY113215	EPBMWT5-A014D	90205
MERCEDES-BENZ	→ NTK	Stock
940048	EPBMFN4-D040H	96545
940948	EPBMFT5-D003P	96835
940948	EPBMFT5-D009H	95803
941048	EPBMFT5-D003P	96835
941048	EPBMFT5-D041H	97661
941248	EPBMFN5-D004P	93343
941348	EPBMFN5-D027H	94938
941448	EPBMFT5-D003P	96835
941448	EPBMFT5-D009H	95803
941448	EPBMFT5-D009H	95803
941948	EPBMFT5-D003P	96835
941948	EPBMFT5-D009H	95803
0000942048	EPBMFN4-D004H	91534
0000942248	EPBMFN4-D014H	92888
0000943248	EPBMFN4-D014H	92888
0000943448	EPBMFN4-D014H	92888
0040943448	EPBMFN4-D014H	92888
41530628	EPBMFN5-D004P	93343
41537328	EPBMFN5-D004P	93343
71906461	EPBMFN5-D027H	94938
1110940148	EPBMWT5-D017H	94348
1120940048	EPBMFT5-D003P	96835
1120940048	EPBMFT5-D025H	90977
1130940048	EPBMFT5-D003P	96835
1130940048	EPBMFT5-D043H	90272
1130940148	EPBMFT5-D047H	97067
2710940248	EPBMWN5-D003H	92791

MERCEDES-BENZ	→ NTK	Stock
2710940248	EPBMWN5-D003H	92791
2730940548	EPBMFT5-V027H	94616
2730940648	EPBMFT5-V027H	94616
2730940948	EPBMFT5-V027H	94616
6110940048	EPBMFN5-D004P	93343
6460940048	EPBMFT5-D018H	96224
6460940048	EPBMFT5-D003P	96835
53013009AA	EPBMFT5-V033H	95261
A0000940048	EPBMFN4-D040H	96545
A0000940948	EPBMFT5-D003P	96835
A0000940948	EPBMFT5-D009H	95803
A0000941048	EPBMFT5-D003P	96835
A0000941048	EPBMFT5-D041H	97661
A0000941248	EPBMFN5-D004P	93343
A0000941348	EPBMFN5-D027H	94938
A0000941348	EPBMFN5-D002P	91609
A0000941448	EPBMFT5-D003P	96835
A0000941448	EPBMFT5-D009H	95803
A0000941948	EPBMFT5-D003P	96835
A0000941948	EPBMFT5-D009H	95803
A0000942048	EPBMFN4-D004H	91534
A0000942248	EPBMFN4-D014H	92888
A0000942848	EPBMFT4-D050H	94911
A0000942948	EPBMFT4-D050H	94911
A0000943248	EPBMFN4-D014H	92888
A0000943348	EPBMFT4-D050H	94911
A0000943448	EPBMFN4-D014H	92888
A0040943448	EPBMFN4-D014H	92888
A0041530628	EPBMFN5-D004P	93343
A0041537328	EPBMFN5-D004P	93343
A0071906461	EPBMFN5-D027H	94938
A1110940148	EPBMWT5-D017H	94348
A1120940048	EPBMFT5-D003P	96835
A1120940048	EPBMFT5-D025H	90977
A1130940048	EPBMFT5-D003P	96835
A1130940048	EPBMFT5-D043H	90272
A1130940148	EPBMFT5-D047H	97067
A2710940248	EPBMWN5-D003H	92791
A2730940648	EPBMFT5-V027H	94616
A2730940748	EPBMFT5-V027H	94616
A2730940848	EPBMFT5-V027H	94616
A2730940948	EPBMFT5-V027H	94616
A6070940048	EPBMWT4-A019H	94808
A6110940048	EPBMFN5-D004P	93343
A6460940048	EPBMFT5-D018H	96224
A6460940048	EPBMFT5-D003P	96835
ME422856	EPBMFT4-V061H	94528
MG	→ NTK	Stock
10004083	EPBMFT5-V001P	93006
MHK101130	EPBMFT5-V001P	93006
MINI	→ NTK	Stock
13627542418	EPBMFN5-A038H	93095

MINI	→ NTK	Stock
13627794972	EPBMFT5-A001H	93740
MITSUBISHI	→ NTK	Stock
1525A001	EPBMFT4-D050H	94911
1525A021	EPBMFT5-V002D	97692
1525A028	EPBMWT4-A026H	95537
1525A033	EPBMFT5-V002D	97692
M887504	EPBMWT6-A001H	90144
MN191135	EPBMFN5-D002H	91692
MN980445	EPBMFN5-D002H	91692
MR547077	EPBMWT5-A005D	93145
MR547077	EPBMWT5-A014D	90205
MR547077	EPBMWT5-A014D	90205
NISSAN	→ NTK	Stock
2268036550	EPBMFN5-A029H	90647
8200280056	EPBMWT6-V013H	92412
1658000Q0A	EPBMWT6-A007H	93605
1658000QAB	EPBMWT6-A001H	90144
1658000QAD	EPBMWT6-V013H	92412
222040D020	EPBMWT5-A005D	93145
2268000QAA	EPBMFT6-A049H	93243
2268000QAB	EPBMWT4-A022H	93854
2268000QAD	EPBMWT4-A019H	94808
226802J200	EPBMWN3-V031H	90825
226805U400	EPBMFT5-A052H	95671
226806N100	EPBMFT5-A063H	91029
226806N101	EPBMFT5-A063H	91029
226806N10A	EPBMFT5-A063H	91029
226807F400	EPBMFT5-V001P	93006
226807F400	EPBMFT5-V042H	94057
226807F400	EPBMFT5-V042H	94057
226807F425	EPBMFT5-V001P	93006
226807F425	EPBMFT5-V042H	94057
226807F425	EPBMFT5-V042H	94057
226807J600	EPBMFN5-A029H	90647
226807S000	EPBMFN5-V005D	90496
226807S00A	EPBMFN5-V005D	90496
226807S00B	EPBMFN5-V005D	90496
22680AW400	EPBMWN5-V005H	93291
22680AW400	EPBMFN5-V005D	90496
22680CA000	EPBMFN5-V005D	90496
22680JD50A	EPBMWT6-A007H	93605
OPEL	→ NTK	Stock
836005	EPBMFT5-T001D	94095
836006	EPBMFT5-T001D	94095
836013	EPBMFT4-V004H	90957
836014	EPBMFT4-V004H	90957
836016	EPBMFN4-V017H	96226
836105	EPBMFT5-V020H	90244
836136	EPBMFT5-V020H	90244
836456	EPBMFT5-T011H	92630
836457	EPBMFT5-T003H	91493
836569	EPBMWN4-A019H	92343



OPEL	→ NTK	Stock
836583	EPBMWT4-V002H	92668
836584	EPBMFT5-V001P	93006
836584	EPBMFT5-V007H	97257
836585	EPBMFT5-V008H	93715
836588	EPBMFT5-V001P	93006
836591	EPBMFT5-V017H	90311
836592	EPBMFT5-V001P	93006
836593	EPBMFT5-V008H	93715
836595	EPBMWT5-V021H	97091
836598	EPBMFT5-V035H	94119
836599	EPBMFT5-V035H	94119
836600	EPBMWT5-V023H	95103
836625	EPBMFN6-R030H	90274
836630	EPBMFT5-V001P	93006
836630	EPBMFT5-V019H	96039
836635	EPBMFT5-V010H	96310
836636	EPBMWT5-V023H	95103
836638	EPBMFT5-V022H	93863
836639	EPBMFN4-V026H	94497
836639	EPBMFN4-V010H	97588
836640	EPBMFT5-V029H	90502
836644	EPBMFT5-V007H	97257
836646	EPBMWN3-V009H	96875
0836646	EPBMWN3-V009H	96875
836647	EPBMFT4-V048H	95493
836651	EPBMFT5-V006H	94366
836654	EPBMFN5-V001D	95368
836655	EPBMFT5-T011H	92630
838628	EPBMFT5-V007H	97257
1882019	EPBMFT5-V001P	93006
4402733	EPBMWT6-A001H	90144
4406095	EPBMWT4-A019H	94808
4506158	EPBMFT6-A044H	92490
6235612	EPBMWT5-V010H	93933
9193149	EPBMFT5-V007H	97257
9193533	EPBMFT5-V008H	93715
9227760	EPBMFT5-V007H	97257
12564298	EPBMWT5-V023H	95103
12576059	EPBMWT5-V023H	95103
12579352	EPBMWT5-V023H	95103
12671610	EPBMFT5-T011H	92630
12671611	EPBMFT5-T003H	91493
13262124	EPBMFT5-T011H	92630
24420614	EPBMFT5-V001P	93006
24437503	EPBMFT5-V019H	96039
55350045	EPBMFT5-V001P	93006
55350046	EPBMWN3-V009H	96875
55350048	EPBMFN4-V010H	97588
55353467	EPBMWT5-V023H	95103
55561304	EPBMFN5-V001D	95368
55561912	EPBMFT5-T011H	92630
55562426	EPBMFT5-T003H	91493

OPEL	→ NTK	Stock
90411957	EPBMWN4-A019H	92343
90529673	EPBMFT5-V007H	97257
90530463	EPBMWT4-V002H	92668
90543282	EPBMFT5-V007H	97257
93171760	EPBMFT5-V008H	93715
93172747	EPBMFT5-V035H	94119
93173727	EPBMFT5-V019H	96039
93174129	EPBMFT5-V001P	93006
93178050	EPBMFT5-V022H	93863
93178243	EPBMFN4-V026H	94497
93178243	EPBMFN4-V010H	97588
93178244	EPBMFT5-V001P	93006
93181894	EPBMFT5-V020H	90244
93184406	EPBMWN3-V009H	96875
93186084	EPBMFT5-V020H	90244
93188724	EPBMFT5-V006H	94366
93189955	EPBMFN5-V001D	95368
93193470	EPBMFN4-V031H	96741
93328218	EPBMFT5-V001P	93006
93863896	EPBMWT4-A019H	94808
95510006	EPBMFT4-V004H	90957
95510015	EPBMFT4-V004H	90957
95513367	EPBMFN4-V017H	96226
634915771	EPBMWN3-V009H	96875
105020A0	EPBMFT5-T001D	94095
PEUGEOT	→ NTK	Stock
163675	EPBMFT4-V004H	90957
9645948780	EPBMWT4-A011H	90069
9647144080	EPBMWT4-A009H	92423
9658127480	EPBMWT4-A001D	95860
9674958880	EPBMWT4-V003D	94395
1192CE	EPBMFN4-V020H	90971
1192CK	EPBMFT4-V061H	94528
1192W5	EPBMFT5-V008H	93715
1192Y9	EPBMFN4-V020H	90971
1920GG	EPBMWT4-A009H	92423
1920GN	EPBMWT4-A011H	90069
PORSCHE	→ NTK	Stock
95860612510	EPBMWT5-A027H	96756
98660612500	EPBMFT5-V001P	93006
98660612500	EPBMFT5-V001P	93006
98660612501	EPBMFT5-V001P	93006
98660612501	EPBMFT5-V001P	93006
99660612300	EPBMFT5-D003P	96835
99660612400	EPBMFT5-V001P	93006
99660612400	EPBMFT5-V001P	93006
RENAULT	→ NTK	Stock
8670113	EPBMFN5-V032H	95044
74207745	EPBMFN5-V032H	95044
7420774533	EPBMFN5-V032H	95044
7700104426	EPBMWT6-A001H	90144
7700109812	EPBMWT6-A001H	90144

RENAULT	→ NTK	Stock
7700114778	EPBMWT6-A001H	90144
7700314057	EPBMFT6-A044H	92490
7700314669	EPBMFT6-A044H	92490
8200230029	EPBMWT6-A001H	90144
8200280056	EPBMWT6-V013H	92412
8200280060	EPBMWT6-A007H	93605
8200280065	EPBMFT6-V046H	95763
8200299956	EPBMFT6-A049H	93243
8200358901	EPBMFT6-A049H	93243
8200651315	EPBMWT4-A019H	94808
8200682558	EPBMWT4-A022H	93854
H8200357204	EPBMWT6-V013H	92412
H8200655623	EPBMWT4-A019H	94808
H8200702517	EPBMWT4-A022H	93854
ROVER	→ NTK	Stock
MHK100850	EPBMFT5-V001P	93006
MHK101070	EPBMFT5-V031H	97525
MHK101130	EPBMFT5-V001P	93006
MHK101130	EPBMFT5-D015H	92304
SAAB	→ NTK	Stock
4662888	EPBMFT5-V001P	93006
4662888	EPBMFT5-V037H	95360
55190587	EPBMFN4-V020H	90971
55562426	EPBMFT5-T003H	91493
90543282	EPBMFT5-V007H	97257
93178243	EPBMFN4-V026H	94497
SCANIA	→ NTK	Stock
55190587	EPBMFN4-V020H	90971
SEAT	→ NTK	Stock
28906461	EPBMFN5-D002P	91609
28906461	EPBMFN5-D015H	90376
38906461	EPBMFN5-D002P	91609
38906461	EPBMFN5-D019H	95991
45906461	EPBMFN5-D002P	91609
45906461	EPBMFN5-D022H	91168
058133471	EPBMWN3-A016H	93176
71906461	EPBMFN5-D027H	94938
74906461	EPBMWN6-D029H	90628
377906461	EPBMFN5-D002P	91609
000VT5077	EPBMFN5-D002P	91609
000VT5077	EPBMFN5-D002H	91692
038906461B	EPBMFN5-D002P	91609
038906461B	EPBMFN5-D003H	95299
038906461C	EPBMFN5-D002P	91609
038906461C	EPBMFN5-D005H	92204
03G906461C	EPBMFN5-D001H	95207
03L906461	EPBMWT3-D024H	91171
03L906461A	EPBMFN4-V008H	95035
058133471X	EPBMWN3-A016H	93176
059906461B	EPBMFT5-D005P	90557
059906461B	EPBMFT5-D032H	91598
059906461BX	EPBMFT5-D005P	90557

SEAT	→ NTK	Stock
059906461BX	EPBMFT5-D032H	91598
059906461D	EPBMWN5-D014H	96884
059906461DX	EPBMWN5-D014H	96884
059906461E	EPBMFT5-D005P	90557
059906461E	EPBMFT5-D045H	95253
059906461EX	EPBMFT5-D005P	90557
059906461EX	EPBMFT5-D045H	95253
059906461G	EPBMWN5-D014H	96884
059906461GX	EPBMWN5-D014H	96884
059906461K	EPBMFN5-D033H	93804
059906461M	EPBMWN5-D014H	96884
059906461MX	EPBMWN5-D014H	96884
059906461N	EPBMWT5-A025H	93777
06A906461	EPBMFN5-D002P	91609
06A906461	EPBMFN5-D005H	92204
06A906461A	EPBMFT5-D005P	90557
06A906461B	EPBMWT4-D014H	93236
06A906461BV	EPBMWT4-D014H	93236
06A906461BX	EPBMWT4-D014H	93236
06A906461C	EPBMFN5-D002P	91609
06A906461C	EPBMFN5-D016H	96999
06A906461D	EPBMFN5-D002P	91609
06A906461D	EPBMFN5-D016H	96999
06A906461E	EPBMFN5-D002P	91609
06A906461E	EPBMFN5-D023H	97946
06A906461G	EPBMFT5-D005P	90557
06A906461GX	EPBMFT5-D005P	90557
06A906461L	EPBMFN5-D002P	91609
06A906461L	EPBMFN5-D012H	96277
06A906461LX	EPBMFN5-D002P	91609
06A906461LX	EPBMFN5-D012H	96277
06A906461M	EPBMFN5-D021H	90140
06A906461MX	EPBMFN5-D021H	90140
06A906461N	EPBMFN5-D002P	91609
06A906461N	EPBMFN5-D025H	94062
06A906461T	EPBMFT5-D005P	90557
06B133471	EPBMFN5-D002P	91609
06B133471	EPBMFN5-D018H	91462
06B133471A	EPBMFT5-D005P	90557
06B133471A	EPBMFT5-D028H	93297
071906461A	EPBMFN5-D002P	91609
071906461A	EPBMFN5-D013H	96315
071906461AX	EPBMFN5-D002P	91609
071906461AX	EPBMFN5-D013H	96315
071906461B	EPBMFT5-D024H	93373
071906461B	EPBMFT5-D005P	90557
071906461B	EPBMFN5-D013H	96315
071906461BX	EPBMFT5-D024H	93373
071906461BX	EPBMFN5-D013H	96315
074906461B	EPBMFN5-D002P	91609
074906461B	EPBMFN5-D002H	91692
074906461BX	EPBMFN5-D002H	91692

SEAT	→ NTK	Stock
074906461X	EPBMWN6-D029H	90628
078133471A	EPBMWN3-A007H	93658
078133471AV	EPBMWN3-A007H	93658
078133471AX	EPBMWN3-A007H	93658
078133471E	EPBMWN4-D018H	96313
1JD906461	EPBMFT5-D005P	90557
581334710V	EPBMWN3-A016H	93176
8Z0906461	EPBMFT5-D054H	94591
8Z0906461	EPBMFT5-D005P	90557
SKODA	→ NTK	Stock
28906461	EPBMFN5-D002P	91609
28906461	EPBMFN5-D015H	90376
38906461	EPBMFN5-D002P	91609
38906461	EPBMFN5-D019H	95991
45906461	EPBMFN5-D002P	91609
45906461	EPBMFN5-D022H	91168
058133471	EPBMWN3-A016H	93176
71906461	EPBMFN5-D027H	94938
74906461	EPBMWN6-D029H	90628
377906461	EPBMFN5-D002P	91609
000VT5077	EPBMFN5-D002P	91609
000VT5077	EPBMFN5-D002H	91692
038906461B	EPBMFN5-D002P	91609
038906461B	EPBMFN5-D003H	95299
038906461C	EPBMFN5-D002P	91609
038906461C	EPBMFN5-D005H	92204
03G906461C	EPBMFN5-D001H	95207
03H906461	EPBMFT5-D040H	97032
03L906461	EPBMWT3-D024H	91171
03L906461A	EPBMFN4-V008H	95035
058133471X	EPBMWN3-A016H	93176
059906461B	EPBMFT5-D005P	90557
059906461B	EPBMFT5-D032H	91598
059906461BX	EPBMFT5-D005P	90557
059906461BX	EPBMFT5-D032H	91598
059906461D	EPBMWN5-D014H	96884
059906461DX	EPBMWN5-D014H	96884
059906461E	EPBMFT5-D005P	90557
059906461E	EPBMFT5-D045H	95253
059906461EX	EPBMFT5-D005P	90557
059906461EX	EPBMFT5-D045H	95253
059906461G	EPBMWN5-D014H	96884
059906461GX	EPBMWN5-D014H	96884
059906461K	EPBMFN5-D033H	93804
059906461M	EPBMWN5-D014H	96884
059906461MX	EPBMWN5-D014H	96884
06A906461	EPBMFN5-D002P	91609
06A906461	EPBMFN5-D005H	92204
06A906461A	EPBMFT5-D005P	90557
06A906461B	EPBMWT4-D014H	93236
06A906461BV	EPBMWT4-D014H	93236
06A906461BX	EPBMWT4-D014H	93236

SKODA	→ NTK	Stock
06A906461C	EPBMFN5-D002P	91609
06A906461C	EPBMFN5-D016H	96999
06A906461D	EPBMFN5-D002P	91609
06A906461D	EPBMFN5-D016H	96999
06A906461E	EPBMFN5-D002P	91609
06A906461E	EPBMFN5-D023H	97946
06A906461G	EPBMFT5-D005P	90557
06A906461GX	EPBMFT5-D005P	90557
06A906461L	EPBMFN5-D002P	91609
06A906461L	EPBMFN5-D012H	96277
06A906461LX	EPBMFN5-D002P	91609
06A906461LX	EPBMFN5-D012H	96277
06A906461N	EPBMFN5-D002P	91609
06A906461N	EPBMFN5-D025H	94062
06A906461T	EPBMFT5-D005P	90557
06B133471	EPBMFN5-D002P	91609
06B133471	EPBMFN5-D018H	91462
06B133471A	EPBMFT5-D005P	90557
06B133471A	EPBMFT5-D028H	93297
071906461A	EPBMFN5-D002P	91609
071906461A	EPBMFN5-D013H	96315
071906461AX	EPBMFN5-D002P	91609
071906461AX	EPBMFN5-D013H	96315
071906461B	EPBMFT5-D005P	90557
071906461B	EPBMFN5-D013H	96315
071906461BX	EPBMFN5-D013H	96315
074906461B	EPBMFN5-D002P	91609
074906461B	EPBMFN5-D002H	91692
074906461BX	EPBMFN5-D002H	91692
074906461X	EPBMWN6-D029H	90628
078133471A	EPBMWN3-A007H	93658
078133471AV	EPBMWN3-A007H	93658
078133471AX	EPBMWN3-A007H	93658
078133471E	EPBMWN4-D018H	96313
1JD906461	EPBMFT5-D005P	90557
581334710V	EPBMWN3-A016H	93176
8Z0906461	EPBMFT5-D054H	94591
8Z0906461	EPBMFT5-D005P	90557
SMART	→ NTK	Stock
A0000942948	EPBMFT4-D050H	94911
A0000943348	EPBMFT4-D050H	94911
SSANGYONG	→ NTK	Stock
6650943148	EPBMFT5-V002H	97685
A6650943148	EPBMFT5-V002H	97685
STEYR	→ NTK	Stock
55350048	EPBMFN4-V010H	97588
1130940048	EPBMFT5-D043H	90272
SUZUKI	→ NTK	Stock
127603	EPBMFT5-V001P	93006
127603	EPBMFT5-V029H	90502
1380084	EPBMWT5-A005D	93145
1380084E00	EPBMWT5-A014D	90205

SUZUKI	→ NTK	Stock
1380084E00000	EPBMWT5-A014D	90205
1380084E00	EPBMWT5-A014D	90205
1380084E00000	EPBMWT5-A014D	90205
1,380084E+56	EPBMFT5-V001P	93006
1,380084E+56	EPBMFT5-V029H	90502
1380054L00	EPBMFT5-V002D	97692
1380055L00	EPBMFT5-V002D	97692
1380063J00	EPBMWT5-A005D	93145
1380067G00	EPBMWT5-A003H	93842
1380067G00000	EPBMWT5-A003H	93842
1380068K00	EPBMFT5-V002D	97692
1380068L50	EPBMFT4-V004H	90957
1380068L50000	EPBMFT4-V004H	90957
1380079J50	EPBMFN4-V026H	94497
1380079J50	EPBMFN4-V010H	97588
1380079J50000	EPBMFN4-V026H	94497
1380079J50000	EPBMFN4-V010H	97588
1380079J50000	EPBMFN4-V010H	97588
1380079J80	EPBMFT4-V004H	90957
1380079J80000	EPBMFT4-V004H	90957
1380080JA0	EPBMFT5-V002D	97692
1380084E50000	EPBMFT5-V001P	93006
1380084E50000	EPBMFT5-V001P	93006
1380084E50000	EPBMFT5-V029H	90502
1380086J00	EPBMFN4-V031H	96741
13800T7950001	EPBMFN4-V010H	97588
13800T7950001	EPBMFN4-V010H	97588
13800T84E50	EPBMFT5-V001P	93006
13800T84E50	EPBMFT5-V001P	93006
13800T84E50	EPBMFT5-V029H	90502
TALBOT	→ NTK	Stock
279715209903	EPBMFT5-V010H	96310
TOYOTA	→ NTK	Stock
2220407010	EPBMWT5-A005D	93145
2220421010	EPBMWT5-A005D	93145
2220422010	EPBMWT5-A014D	90205
2220422010	EPBMWT5-A014D	90205
2220426010	EPBMWT5-V012D	95034
2220427010	EPBMWT5-A004D	91831
2220428010	EPBMFT5-V002D	97692
2220430010	EPBMWT5-A014D	90205
2220430010	EPBMWT5-A014D	90205
2220431010	EPBMWT5-A006D	91258
2220431020	EPBMWT5-A006D	91258
2220433010	EPBMWT5-A014D	90205
2220433010	EPBMWT5-A014D	90205
2220437010	EPBMFT5-V002D	97692
222040C020	EPBMWT5-A014D	90205
222040C020	EPBMWT5-A014D	90205
222040D020	EPBMWT5-A005D	93145
222040D020	EPBMWT5-A014D	90205
222040D020	EPBMWT5-A014D	90205

TOYOTA	→ NTK	Stock
222040D030	EPBMWT5-A014D	90205
222040D030	EPBMWT5-A014D	90205
222040H010	EPBMWT5-A006D	91258
222040J010	EPBMWT5-A014D	90205
222040J010	EPBMWT5-A014D	90205
222040L010	EPBMWT5-A014D	90205
222040L010	EPBMWT5-A014D	90205
222040N010	EPBMWT5-A014D	90205
222040N010	EPBMWT5-A014D	90205
222040P010	EPBMWT5-A006D	91258
222040P020	EPBMFT5-V002D	97692
222040T010	EPBMWT5-A006D	91258
222040T020	EPBMFT5-V002D	97692
222040T030	EPBMFT5-V002D	97692
222040T040	EPBMFT5-V002D	97692
222040V010	EPBMFT5-V002D	97692
222040V020	EPBMFT5-V002D	97692
SU00100643	EPBMWT4-A009H	92423
UAZ	→ NTK	Stock
203855	EPBMFT5-V039H	90466
293376300004	EPBMFT5-V039H	90466
316023877012	EPBMFT5-V039H	90466
316023877014	EPBMFT5-V039H	90466
VAG	→ NTK	Stock
28906461	EPBMFN5-D002P	91609
28906461	EPBMFN5-D015H	90376
38906461	EPBMFN5-D002P	91609
38906461	EPBMFN5-D019H	95991
45906461	EPBMFN5-D002P	91609
45906461	EPBMFN5-D022H	91168
71906461	EPBMFN5-D027H	94938
74906461	EPBMWN6-D029H	90628
377906461	EPBMFN5-D002P	91609
000VT5077	EPBMFN5-D002P	91609
000VT5077	EPBMFN5-D002H	91692
038906461B	EPBMFN5-D002P	91609
038906461B	EPBMFN5-D003H	95299
038906461BX	EPBMFN5-D003H	95299
038906461C	EPBMFN5-D002P	91609
038906461C	EPBMFN5-D005H	92204
03L906461	EPBMWT3-D024H	91171
059906461B	EPBMFT5-D005P	90557
059906461B	EPBMFT5-D032H	91598
059906461BX	EPBMFT5-D005P	90557
059906461BX	EPBMFT5-D032H	91598
059906461E	EPBMFT5-D005P	90557
059906461E	EPBMFT5-D045H	95253
059906461E	EPBMFT5-D032H	91598
059906461EX	EPBMFT5-D005P	90557
059906461EX	EPBMFT5-D045H	95253
059906461N	EPBMWT5-A025H	93777
06A906461	EPBMFN5-D002P	91609

VAG	→ NTK	Stock
06A906461	EPBMFN5-D005H	92204
06A906461A	EPBMFT5-D005P	90557
06A906461C	EPBMFN5-D002P	91609
06A906461C	EPBMFN5-D016H	96999
06A906461D	EPBMFN5-D002P	91609
06A906461D	EPBMFN5-D016H	96999
06A906461E	EPBMFN5-D002P	91609
06A906461E	EPBMFN5-D023H	97946
06A906461G	EPBMFT5-D005P	90557
06A906461GX	EPBMFT5-D005P	90557
06A906461L	EPBMFN5-D002P	91609
06A906461L	EPBMFN5-D012H	96277
06A906461LX	EPBMFN5-D002P	91609
06A906461LX	EPBMFN5-D012H	96277
06A906461N	EPBMFN5-D002P	91609
06A906461N	EPBMFN5-D025H	94062
06A906461T	EPBMFT5-D005P	90557
06B133471	EPBMFN5-D002P	91609
06B133471	EPBMFN5-D018H	91462
06B133471A	EPBMFT5-D005P	90557
06B133471A	EPBMFT5-D028H	93297
071906461A	EPBMFN5-D002P	91609
071906461A	EPBMFN5-D013H	96315
071906461AX	EPBMFN5-D002P	91609
071906461AX	EPBMFN5-D013H	96315
071906461B	EPBMFT5-D005P	90557
071906461B	EPBMFN5-D013H	96315
071906461BX	EPBMFN5-D013H	96315
074906461B	EPBMFN5-D002P	91609
074906461B	EPBMFN5-D002H	91692
074906461BX	EPBMFN5-D002H	91692
074906461X	EPBMWN6-D029H	90628
078133471E	EPBMWN4-D018H	96313
1JD906461	EPBMFT5-D005P	90557
8Z0906461	EPBMFT5-D054H	94591
8Z0906461	EPBMFT5-D005P	90557
VAUXHALL	→ NTK	Stock
9193533	EPBMFT5-V008H	93715
12671610	EPBMFT5-T011H	92630
12671611	EPBMFT5-T003H	91493
13262124	EPBMFT5-T011H	92630
55561912	EPBMFT5-T011H	92630
55562426	EPBMFT5-T003H	91493
93171760	EPBMFT5-V008H	93715
93172747	EPBMFT5-V035H	94119
93178050	EPBMFT5-V022H	93863
93178243	EPBMFN4-V026H	94497
93181894	EPBMFT5-V020H	90244
93186084	EPBMFT5-V020H	90244
93188724	EPBMFT5-V006H	94366
93863896	EPBMWT4-A019H	94808
95510006	EPBMFT4-V004H	90957

VAUXHALL	→ NTK	Stock
95510015	EPBMFT4-V004H	90957
95513367	EPBMFN4-V017H	96226
VOLVO	→ NTK	Stock
8627296	EPBMFT5-V001P	93006
8627296	EPBMFT5-V021H	95278
8627297	EPBMFN5-V032H	95044
8658471	EPBMWT5-A005D	93145
8658471	EPBMWT5-A014D	90205
8658471	EPBMWT5-A014D	90205
8670093	EPBMWT4-A008H	90627
8670112	EPBMFT5-V001P	93006
8670112	EPBMFT5-V021H	95278
8670113	EPBMFN5-V032H	95044
8670114	EPBMFN5-V032H	95044
8670115	EPBMFT5-V001P	93006
8670115	EPBMFN5-V032H	95044
8670115	EPBMFT5-V021H	95278
8670263	EPBMFT5-V001P	93006
8670263	EPBMFT5-V021H	95278
8670398	EPBMFT5-V001P	93006
8670398	EPBMFT5-V021H	95278
8692624	EPBMFT5-V021H	95278
9202199	EPBMWT5-A005D	93145
9202199	EPBMWT5-A014D	90205
9202199	EPBMWT5-A014D	90205
9202199	EPBMWT5-A014D	90205
9202199	EPBMWT5-A014D	90205
9445148	EPBMFT5-V021H	95278
9470640	EPBMFT5-V021H	95278
9470776	EPBMFN5-V032H	95044
9545148	EPBMFT5-V021H	95278
30611532	EPBMWN3-A023H	91067
30611533	EPBMWT5-D020H	97934
30622124	EPBMFT5-A001H	93740
30677999	EPBMFN4-V007H	93735
30713512	EPBMWT5-A005D	93145
30713512	EPBMWT5-A014D	90205
30713512	EPBMWT5-A014D	90205
30713512	EPBMWT5-A014D	90205
30713512	EPBMWT5-A014D	90205
30757655	EPBMWT4-V003D	94395
30774680	EPBMWT4-V002D	95695
30774680	EPBMFT5-A001H	93740
30777415	EPBMWT4-A001D	95860
30887504	EPBMWT6-A001H	90144
31251735	EPBMWT4-V002D	95695
31312734	EPBMFN4-V007H	93735
31321906	EPBMFT5-V002D	97692
31331525	EPBMFN4-V007H	93735
31342362	EPBMFT5-V001P	93006
31342362	EPBMFT5-V021H	95278
31342363	EPBMFN5-V032H	95044

VOLVO	→ NTK	Stock
31342364	EPBMFT5-V021H	95278
31342414	EPBMFT5-V021H	95278
31380619	EPBMFT5-V002D	97692
31459402	EPBMFN4-V007H	93735
31459405	EPBMFN4-V007H	93735
86701130	EPBMFN5-V032H	95044
86701140	EPBMFN5-V032H	95044
86702630	EPBMFT5-V021H	95278
86703980	EPBMFT5-V001P	93006
86703980	EPBMFN5-V032H	95044
86703980	EPBMFT5-V021H	95278
86926240	EPBMFT5-V021H	95278
94706400	EPBMFT5-V001P	93006
94706400	EPBMFT5-V021H	95278
VW	→ NTK	Stock
058133471	EPBMWN3-A016H	93176
78133471	EPBMWN3-A007H	93658
420133471	EPBMWT5-V013D	92480
03G906461C	EPBMFN5-D001H	95207
03H906461	EPBMFT5-D040H	97032
03L906461A	EPBMFN4-V008H	95035
057906461A	EPBMFT5-D014H	95484
057906461AX	EPBMFT5-D014H	95484
058133471X	EPBMWN3-A016H	93176
059906461D	EPBMWN5-D014H	96884
059906461DV	EPBMWN5-D014H	96884
059906461DX	EPBMWN5-D014H	96884
059906461G	EPBMWN5-D014H	96884
059906461GV	EPBMWN5-D014H	96884
059906461GX	EPBMWN5-D014H	96884
059906461K	EPBMFN5-D033H	93804
059906461M	EPBMWN5-D014H	96884
059906461MV	EPBMWN5-D014H	96884
059906461MX	EPBMWN5-D014H	96884
059906461N	EPBMWT5-A025H	93777
06A906461B	EPBMWT4-D014H	93236
06A906461BV	EPBMWT4-D014H	93236
06A906461BX	EPBMWT4-D014H	93236
06A906461M	EPBMFN5-D021H	90140
06A906461MX	EPBMFN5-D021H	90140
071906461B	EPBMFT5-D024H	93373
071906461BX	EPBMFT5-D024H	93373
078133471A	EPBMWN3-A007H	93658
078133471AV	EPBMWN3-A007H	93658
078133471AX	EPBMWN3-A007H	93658
078133471C	EPBMWN3-A021H	93365
078133471CV	EPBMWN3-A021H	93365
078133471CX	EPBMWN3-A021H	93365
07D906461	EPBMFT5-D038H	96961
07D906461X	EPBMFT5-D038H	96961
2E0906461	EPBMFN4-D014H	92888
2E0906461C	EPBMFN4-D014H	92888

VW	→ NTK	Stock
3L7Z12B579AA	EPBMWN3-A016H	93176
581334710V	EPBMWN3-A016H	93176
59906461F	EPBMWN5-D014H	96884



Industry

BLUEPRINT	→ NTK	Stock
ADB117401	EPBMFT5-A001H	93740
ADC47435	EPBMWT4-A008H	90627
ADG07415	EPBMFT5-V017H	90311
ADG07416	EPBMFT5-V010H	96310
ADG07417	EPBMFN3-A028H	94128
ADG07420	EPBMFN4-V026H	94497
ADG07420	EPBMFN4-V010H	97588
ADG074203	EPBMFT5-V013H	96559
ADG074204	EPBMFT5-V055H	91808
ADG074204	EPBMFT5-V001P	93006
ADG074204	EPBMFT5-V030H	96975
ADG074213	EPBMFN4-A035H	97899
ADG074214C	EPBMFT5-V029H	90502
ADG074214C	EPBMFT5-V001P	93006
ADG074216	EPBMFT5-V017H	90311
ADG074217C	EPBMFT5-V005H	93645
ADG074218C	EPBMFT5-V002H	97685
ADG074220	EPBMWT5-D012H	91007
ADG074221	EPBMWN3-A017H	95114
ADG074232	EPBMWT5-D012H	91007
ADG074237	EPBMFT5-T011H	92630
ADG074239	EPBMFT5-T001D	94095
ADH274207	EPBMWN5-V004D	94183
ADJ137401	EPBMFT5-D015H	92304
ADJ137401	EPBMFT5-V001P	93006
ADJ137402	EPBMWT4-A001D	95860
ADK87401	EPBMWT5-A003H	93842
ADK87402	EPBMFT5-V002D	97692
ADM574210	EPBMWT5-A014D	90205
ADM574210	EPBMWT5-A005D	93145
ADN17409	EPBMWT6-A001H	90144
ADN174201	EPBMWN3-V031H	90825
ADN174202	EPBMWN5-V005H	93291
ADN174203C	EPBMFN5-V005D	90496
ADN174206	EPBMFT5-A052H	95671
ADN174207C	EPBMFN5-V005D	90496
ADN174211	EPBMFT5-V001P	93006
ADN174211	EPBMFT5-V042H	94057
ADN174213	EPBMFT6-A049H	93243
ADN174214	EPBMWT6-A007H	93605
ADN174215	EPBMWT6-A007H	93605
ADT374202C	EPBMWT5-A014D	90205
ADT374204	EPBMWT5-A014D	90205
ADT374204	EPBMWT5-A009D	97997
ADT374205	EPBMWT5-A004D	91831
ADT374207	EPBMWT5-A014D	90205
ADT374207	EPBMWT5-A011D	92781
ADT374210	EPBMWT5-A014D	90205
ADT374210	EPBMWT5-A009D	97997
ADT374213	EPBMWT5-A006D	91258
ADT374214	EPBMWT5-V012D	95034
ADZ97402C	EPBMFT5-V035H	94119

BOSCH	→ NTK	Stock
0 280 217 007	EPBMFT5-D003P	96835
0 280 217 100	EPBMFN4-D040H	96545
0 280 217 105	EPBMFN4-A035H	97899
0 280 217 107	EPBMFT5-V017H	90311
0 280 217 107	EPBMFN4-A039H	95306
0 280 217 112	EPBMFN4-A046H	90609
0 280 217 114	EPBMFT5-D009H	95803
0 280 217 114	EPBMFT5-D003P	96835
0 280 217 117	EPBMFN4-A037H	94866
0 280 217 121	EPBMFN5-D002P	91609
0 280 217 121	EPBMFN5-D005H	92204
0 280 217 123	EPBMFT5-V001P	93006
0 280 217 123	EPBMFT5-V007H	97257
0 280 217 124	EPBMFT5-D012H	93496
0 280 217 503	EPBMFN4-A041H	97353
0 280 217 515	EPBMFT5-D025H	90977
0 280 217 515	EPBMFT5-D003P	96835
0 280 217 517	EPBMFT5-D003P	96835
0 280 217 517	EPBMFT5-D041H	97661
0 280 217 519	EPBMFN4-V036H	95777
0 280 217 523	EPBMFN5-D002P	91609
0 280 217 523	EPBMFN5-D027H	94938
0 280 217 529	EPBMFN5-D002P	91609
0 280 217 529	EPBMFN5-D013H	96315
0 280 217 529	EPBMFN5-D016H	96999
0 280 217 531	EPBMFT5-V008H	93715
0 280 217 810	EPBMFT5-D043H	90272
0 280 217 810	EPBMFT5-D003P	96835
0 280 217 814	EPBMFT5-D060H	95878
0 280 218 001	EPBMFT5-V001P	93006
0 280 218 001	EPBMFT5-V007H	97257
0 280 218 002	EPBMFT5-D005P	90557
0 280 218 004	EPBMFT5-V001P	93006
0 280 218 004	EPBMFT5-V007H	97257
0 280 218 005	EPBMFN5-A029H	90647
0 280 218 009	EPBMFT5-V001P	93006
0 280 218 012	EPBMFT5-V001P	93006
0 280 218 012	EPBMFT5-V031H	97525
0 280 218 013	EPBMFN5-D018H	91462
0 280 218 013	EPBMFN5-D002P	91609
0 280 218 017	EPBMFT5-D005P	90557
0 280 218 017	EPBMFT5-D024H	93373
0 280 218 019	EPBMFT5-V017H	90311
0 280 218 019	EPBMFT5-V001P	93006
0 280 218 020	EPBMFT5-V017H	90311
0 280 218 023	EPBMFN5-D002P	91609
0 280 218 023	EPBMFN5-D016H	96999
0 280 218 031	EPBMFT5-V001P	93006
0 280 218 031	EPBMFT5-V007H	97257
0 280 218 032	EPBMFN5-D002P	91609
0 280 218 032	EPBMFN5-D016H	96999
0 280 218 034	EPBMFN5-D002P	91609





BOSCH	→ NTK	Stock
0 280 218 034	EPBMFN5-D023H	97946
0 280 218 037	EPBMFT5-V039H	90466
0 280 218 051	EPBMFT5-V017H	90311
0 280 218 051	EPBMFT5-V001P	93006
0 280 218 053	EPBMFN5-D002P	91609
0 280 218 055	EPBMFT5-V001P	93006
0 280 218 058	EPBMFT5-D005P	90557
0 280 218 058	EPBMFT5-D028H	93297
0 280 218 060	EPBMFT5-D005P	90557
0 280 218 063	EPBMFN5-D002P	91609
0 280 218 063	EPBMFN5-D012H	96277
0 280 218 065	EPBMFN5-D021H	90140
0 280 218 073	EPBMFT5-D038H	96961
0 280 218 075	EPBMFT5-D036H	90481
0 280 218 075	EPBMFT5-D016H	95579
0 280 218 075	EPBMFT5-D003P	96835
0 280 218 081	EPBMFT5-D009H	95803
0 280 218 081	EPBMFT5-D003P	96835
0 280 218 087	EPBMFT5-V035H	94119
0 280 218 089	EPBMFN5-V032H	95044
0 280 218 092	EPBMFT5-V033H	95261
0 280 218 094	EPBMFT5-A052H	95671
0 280 218 100	EPBMFN5-D002P	91609
0 280 218 100	EPBMFN5-D025H	94062
0 280 218 104	EPBMFT5-V033H	95261
0 280 218 109	EPBMFN5-V032H	95044
0 280 218 113	EPBMFT5-V001P	93006
0 280 218 119	EPBMFT5-V001P	93006
0 280 218 119	EPBMFT5-V007H	97257
0 280 218 120	EPBMFT5-V039H	90466
0 280 218 120	EPBMFT5-V001P	93006
0 280 218 124	EPBMFT5-D005P	90557
0 280 218 130	EPBMFT5-V055H	91808
0 280 218 130	EPBMFT5-V030H	96975
0 280 218 134	EPBMFT5-V001P	93006
0 280 218 134	EPBMFT5-V021H	95278
0 280 218 135	EPBMFT5-D056H	90827
0 280 218 142	EPBMFT5-V017H	90311
0 280 218 142	EPBMFT5-V001P	93006
0 280 218 159	EPBMFT5-D034H	96295
0 280 218 175	EPBMFT5-D040H	97032
0 280 218 183	EPBMFT5-V010H	96310
0 280 218 190	EPBMFT5-V027H	94616
0 280 218 199	EPBMFT5-V002H	97685
0 280 218 205	EPBMFN5-A038H	93095
0 280 218 207	EPBMFT5-T011H	92630
0 280 218 209	EPBMFT5-T062H	91666
0 280 218 211	EPBMFT5-V020H	90244
0 280 218 237	EPBMFT4-V061H	94528
0 280 218 254	EPBMFT5-T001D	94095
0 280 218 268	EPBMFT5-T001D	94095
0 280 218 299	EPBMFT4-V061H	94528

BOSCH	→ NTK	Stock
0 280 218 382	EPBMFT5-V001P	93006
0 280 218 382	EPBMFT5-V007H	97257
0 280 218 401	EPBMFT5-V001P	93006
0 280 218 412	EPBMFT5-V010H	96310
0 280 218 421	EPBMFT5-T011H	92630
0 280 218 423	EPBMFT5-T062H	91666
0 280 218 427	EPBMFT5-T003H	91493
0 280 218 429	EPBMFT5-T001D	94095
0 281 002 139	EPBMFN4-A045H	92062
0 281 002 152	EPBMFN5-D004P	93343
0 281 002 180	EPBMFT5-V017H	90311
0 281 002 180	EPBMFT5-V001P	93006
0 281 002 182	EPBMFT5-V001P	93006
0 281 002 182	EPBMFN5-V043H	93581
0 281 002 184	EPBMFT5-V001P	93006
0 281 002 184	EPBMFT5-V008H	93715
0 281 002 195	EPBMFN4-A039H	95306
0 281 002 199	EPBMFT5-V017H	90311
0 281 002 199	EPBMFT5-V001P	93006
0 281 002 207	EPBMFT5-V001P	93006
0 281 002 207	EPBMFT5-V042H	94057
0 281 002 212	EPBMFT5-V001P	93006
0 281 002 212	EPBMFT5-V037H	95360
0 281 002 216	EPBMFN5-D015H	90376
0 281 002 216	EPBMFN5-D002P	91609
0 281 002 281	EPBMFN5-D004P	93343
0 281 002 309	EPBMFT5-V001P	93006
0 281 002 318	EPBMFN5-D022H	91168
0 281 002 318	EPBMFN5-D002P	91609
0 281 002 384	EPBMFT5-D009H	95803
0 281 002 384	EPBMFT5-D003P	96835
0 281 002 403	EPBMFT5-D005P	90557
0 281 002 403	EPBMFT5-D032H	91598
0 281 002 428	EPBMFT5-V017H	90311
0 281 002 428	EPBMFT5-V001P	93006
0 281 002 429	EPBMFT5-D005P	90557
0 281 002 429	EPBMFT5-D032H	91598
0 281 002 429	EPBMFT5-D045H	95253
0 281 002 443	EPBMFT5-V058H	93155
0 281 002 447	EPBMFT5-V017H	90311
0 281 002 461	EPBMFN5-D002P	91609
0 281 002 461	EPBMFN5-D002H	91692
0 281 002 463	EPBMFN5-D002P	91609
0 281 002 463	EPBMFN5-D019H	95991
0 281 002 478	EPBMFT5-V010H	96310
0 281 002 479	EPBMFT5-V001P	93006
0 281 002 479	EPBMFT5-V019H	96039
0 281 002 482	EPBMFT5-V039H	90466
0 281 002 482	EPBMFT5-V001P	93006
0 281 002 489	EPBMFN5-D004P	93343
0 281 002 501	EPBMFT5-V033H	95261
0 281 002 531	EPBMFN5-D002P	91609





Industry

BOSCH	→ NTK	Stock
0 281 002 531	EPBMFN5-D003H	95299
0 281 002 535	EPBMFT5-D018H	96224
0 281 002 535	EPBMFT5-D003P	96835
0 281 002 536	EPBMFT5-D018H	96224
0 281 002 536	EPBMFT5-D003P	96835
0 281 002 537	EPBMFT5-V035H	94119
0 281 002 549	EPBMFT5-V001P	93006
0 281 002 549	EPBMFT5-V010H	96310
0 281 002 554	EPBMFT5-V055H	91808
0 281 002 554	EPBMFT5-V001P	93006
0 281 002 554	EPBMFT5-V030H	96975
0 281 002 564	EPBMFT5-V055H	91808
0 281 002 564	EPBMFT5-V030H	96975
0 281 002 567	EPBMFN4-D004H	91534
0 281 002 571	EPBMFT5-V053H	95935
0 281 002 585	EPBMFN4-D004H	91534
0 281 002 585	EPBMFN4-D014H	92888
0 281 002 586	EPBMFN4-D014H	92888
0 281 002 598	EPBMFT5-V001P	93006
0 281 002 598	EPBMFT5-V035H	94119
0 281 002 600	EPBMFT5-V010H	96310
0 281 002 605	EPBMFT5-V057H	91176
0 281 002 613	EPBMFT5-V029H	90502
0 281 002 613	EPBMFT5-V001P	93006
0 281 002 619	EPBMFT5-V029H	90502
0 281 002 619	EPBMFT5-V001P	93006
0 281 002 620	EPBMFT5-V022H	93863
0 281 002 621	EPBMFT5-D059H	94271
0 281 002 656	EPBMFN4-D014H	92888
0 281 002 669	EPBMFT5-V053H	95935
0 281 002 683	EPBMFN4-V026H	94497
0 281 002 683	EPBMFN4-V010H	97588
0 281 002 713	EPBMFN4-D009H	96113
0 281 002 721	EPBMFT5-V002H	97685
0 281 002 723	EPBMFT5-V005H	93645
0 281 002 735	EPBMFN5-D001H	95207
0 281 002 757	EPBMFN5-D002P	91609
0 281 002 757	EPBMFN5-D005H	92204
0 281 002 763	EPBMFN4-V020H	90971
0 281 002 764	EPBMFN4-V020H	90971
0 281 002 779	EPBMFN5-D047H	91140
0 281 002 779	EPBMFN5-D002P	91609
0 281 002 792	EPBMFN4-V017H	96226
0 281 002 830	EPBMFN5-V001D	95368
0 281 002 832	EPBMFT5-V006H	94366
0 281 002 849	EPBMFN4-D009H	96113
0 281 002 860	EPBMFT4-V004H	90957
0 281 002 861	EPBMFN4-V026H	94497
0 281 002 861	EPBMFN4-V010H	97588
0 281 002 862	EPBMFN4-V031H	96741
0 281 002 873	EPBMFN4-V017H	96226
0 281 002 896	EPBMFN4-D014H	92888

BOSCH	→ NTK	Stock
0 281 002 912	EPBMFT5-T003H	91493
0 281 002 917	EPBMFT4-V004H	90957
0 281 002 936	EPBMFN4-D009H	96113
0 281 002 940	EPBMFT5-T011H	92630
0 281 002 956	EPBMFN4-V008H	95035
0 281 002 978	EPBMFN4-D014H	92888
0 281 002 980	EPBMFN4-V017H	96226
0 281 006 048	EPBMFN4-V020H	90971
0 281 006 054	EPBMFT4-V004H	90957
0 281 006 056	EPBMFT4-V061H	94528
0 281 006 073	EPBMFT4-V061H	94528
0 281 006 146	EPBMFN4-D004H	91534
0 281 006 147	EPBMFN4-D009H	96113
0 281 006 154	EPBMFT4-V061H	94528
0 928 400 520	EPBMFT5-D015H	92304
0 928 400 520	EPBMFT5-V001P	93006
0 928 400 527	EPBMFT5-D023H	93770
0 928 400 527	EPBMFT5-D003P	96835
0 928 400 529	EPBMFN4-D011H	94586
0 986 280 101	EPBMFN6-A034H	91004
0 986 280 201	EPBMFN4-A037H	94866
0 986 280 202	EPBMFN5-D002P	91609
0 986 280 202	EPBMFN5-D005H	92204
0 986 280 204	EPBMFN5-D002P	91609
0 986 280 204	EPBMFN5-D013H	96315
0 986 280 205	EPBMFT5-D005P	90557
0 986 280 206	EPBMFN5-D018H	91462
0 986 280 206	EPBMFN5-D002P	91609
0 986 280 208	EPBMFT5-D005P	90557
0 986 280 208	EPBMFT5-D024H	93373
0 986 280 208	EPBMFN5-D013H	96315
0 986 280 209	EPBMFN5-D002P	91609
0 986 280 209	EPBMFN5-D016H	96999
0 986 280 210	EPBMFN5-D002P	91609
0 986 280 210	EPBMFN5-D016H	96999
0 986 280 211	EPBMFN5-D002P	91609
0 986 280 211	EPBMFN5-D023H	97946
0 986 280 215	EPBMFT5-D005P	90557
0 986 280 215	EPBMFT5-D028H	93297
0 986 280 216	EPBMFT5-D005P	90557
0 986 280 217	EPBMFN5-D002P	91609
0 986 280 217	EPBMFN5-D012H	96277
0 986 280 218	EPBMFN5-D021H	90140
0 986 280 222	EPBMFT5-D038H	96961
0 986 280 223	EPBMFN5-D002P	91609
0 986 280 223	EPBMFN5-D025H	94062
0 986 280 230	EPBMFT5-V001P	93006
0 986 280 230	EPBMFT5-V007H	97257
0 986 280 231	EPBMFT5-V017H	90311
0 986 280 231	EPBMFT5-V001P	93006
0 986 280 232	EPBMFN5-A029H	90647
0 986 280 700	EPBMWT4-V003D	94395





BOSCH	→ NTK	Stock
0 986 280 701	EPBMWT4-V002D	95695
0 986 280 702	EPBMWT4-A026H	95537
0 986 280 703	EPBMWT4-A001D	95860
0 986 280 704	EPBMWT4-D014H	93236
0 986 280 705	EPBMWN6-A001D	91743
0 986 280 708	EPBMFN5-D033H	93804
0 986 280 709	EPBMWN3-V009H	96875
0 986 280 710	EPBMWN4-A012H	96882
0 986 280 711	EPBMWN4-A011H	96418
0 986 284 001	EPBMFN5-D015H	90376
0 986 284 001	EPBMFN5-D002P	91609
0 986 284 002	EPBMFN5-D022H	91168
0 986 284 002	EPBMFN5-D002P	91609
0 986 284 004	EPBMFT5-D005P	90557
0 986 284 004	EPBMFT5-D032H	91598
0 986 284 005	EPBMFT5-D005P	90557
0 986 284 005	EPBMFT5-D032H	91598
0 986 284 005	EPBMFT5-D045H	95253
0 986 284 007	EPBMFN5-D002P	91609
0 986 284 007	EPBMFN5-D002H	91692
0 986 284 008	EPBMFN5-D002P	91609
0 986 284 008	EPBMFN5-D019H	95991
0 986 284 009	EPBMFN5-D002P	91609
0 986 284 009	EPBMFN5-D003H	95299
0 986 284 012	EPBMFT5-V001P	93006
0 986 284 012	EPBMFT5-V042H	94057
0 986 JG0 313	EPBMWN5-V008H	92710
0 986 JG1 609	EPBMWT5-V012D	95034
0 986 JG1 610	EPBMWT5-A004D	91831
0 986 JG1 618	EPBMFN5-V005D	90496
0 986 JG1 623	EPBMWN5-V005H	93291
0 986 JG1 624	EPBMFN5-V005D	90496
0 986 JG1 630	EPBMWN5-V004D	94183
DELPHI	→ NTK	Stock
AF10053-11B1	EPBMWN6-D029H	90628
AF10053-12B1	EPBMWN6-D029H	90628
AF10071-12B1	EPBMFN6-R030H	90274
AF10072-12B1	EPBMFN5-D004P	93343
AF10075-12B1	EPBMFT5-A001H	93740
AF10075-12B1	EPBMWT4-V002D	95695
AF10078-12B1	EPBMFN5-D022H	91168
AF10078-12B1	EPBMFN5-D002P	91609
AF10078-12B1	EPBMFN5-D005H	92204
AF10078-12B1	EPBMFN5-D003H	95299
AF10079-12B1	EPBMFT5-D005P	90557
AF10079-12B1	EPBMFT5-D024H	93373
AF10079-12B1	EPBMFN5-D013H	96315
AF10081-12B1	EPBMFN5-D002P	91609
AF10081-12B1	EPBMFN5-D013H	96315
AF10083-12B1	EPBMFN5-D015H	90376
AF10083-12B1	EPBMFN5-D002P	91609
AF10083-12B1	EPBMFN5-D019H	95991

DELPHI	→ NTK	Stock
AF10084-12B1	EPBMFT5-D005P	90557
AF10084-12B1	EPBMFT5-D032H	91598
AF10084-12B1	EPBMFT5-D045H	95253
AF10088-12B1	EPBMWT5-V010H	93933
AF10131	EPBMWN3-A016H	93176
AF10131-11B1	EPBMWN3-A016H	93176
AF10135-11B1	EPBMWT5-A014D	90205
AF10135-11B1	EPBMWT5-A005D	93145
AF10135-12B1	EPBMWT5-A014D	90205
AF10135-12B1	EPBMWT5-A005D	93145
AF10141-11B1	EPBMFN5-V005D	90496
AF10143-12B1	EPBMFT6-A026H	93281
AF10144-11B1	EPBMWN5-D006H	92698
AF10144-11B1	EPBMWN5-D003D	94436
AF10144-12B1	EPBMWN5-D006H	92698
AF10144-12B1	EPBMWN5-D003D	94436
AF10147-11B1	EPBMWT5-V023H	95103
AF10148-11B1	EPBMWN4-D018H	96313
AF10152	EPBMWN3-V031H	90825
AF10152-11B1	EPBMWN3-V031H	90825
AF10156-11B1	EPBMFT5-D005P	90557
AF10156-11B1	EPBMFN5-D022H	91168
AF10156-11B1	EPBMFT5-D032H	91598
AF10156-11B1	EPBMFN5-D002P	91609
AF10156-11B1	EPBMFT5-D024H	93373
AF10156-11B1	EPBMFT5-D012H	93496
AF10156-11B1	EPBMFT5-D045H	95253
AF10156-11B1	EPBMFN5-D013H	96315
AF10156-11B1	EPBMFN5-D016H	96999
AF10156-12B1	EPBMFT5-D005P	90557
AF10156-12B1	EPBMFN5-D022H	91168
AF10156-12B1	EPBMFT5-D032H	91598
AF10156-12B1	EPBMFN5-D002P	91609
AF10156-12B1	EPBMFT5-D024H	93373
AF10156-12B1	EPBMFT5-D012H	93496
AF10156-12B1	EPBMFT5-D045H	95253
AF10156-12B1	EPBMFN5-D013H	96315
AF10156-12B1	EPBMFN5-D016H	96999
AF10156-12B1	EPBMFT5-D005P	90557
AF10156-12B1	EPBMFN5-D022H	91168
AF10156-12B1	EPBMFT5-D032H	91598
AF10156-12B1	EPBMFN5-D002P	91609
AF10156-12B1	EPBMFT5-D024H	93373
AF10156-12B1	EPBMFT5-D012H	93496
AF10156-12B1	EPBMFT5-D045H	95253
AF10156-12B1	EPBMFN5-D013H	96315
AF10156-12B1	EPBMFN5-D016H	96999
AF10157-11B1	EPBMFN5-D015H	90376
AF10157-11B1	EPBMFT5-D005P	90557
AF10157-11B1	EPBMFT5-D032H	91598
AF10157-11B1	EPBMFT5-D002P	91609
AF10157-11B1	EPBMFN5-D025H	94062
AF10157-11B1	EPBMFN5-D012H	96277
AF10157-11B1	EPBMFT5-D038H	96961
AF10157-12B1	EPBMFN5-D015H	90376
AF10157-12B1	EPBMFT5-D005P	90557
AF10157-12B1	EPBMFT5-D032H	91598
AF10157-12B1	EPBMFN5-D002P	91609
AF10157-12B1	EPBMFN5-D025H	94062
AF10157-12B1	EPBMFN5-D012H	96277
AF10157-12B1	EPBMFT5-D038H	96961





Industry

DELPHI	→ NTK	Stock
AF10158-11B1	EPBMFT5-D025H	90977
AF10158-11B1	EPBMFT5-D003P	96835
AF10158-12B1	EPBMFT5-D025H	90977
AF10158-12B1	EPBMFT5-D003P	96835
AF10167-11B1	EPBMFT5-D005P	90557
AF10167-11B1	EPBMFN5-D002P	91609
AF10167-11B1	EPBMFT5-D024H	93373
AF10167-11B1	EPBMFN5-D013H	96315
AF10167-11B1	EPBMFN5-D016H	96999
AF10167-12B1	EPBMFT5-D005P	90557
AF10167-12B1	EPBMFN5-D002P	91609
AF10167-12B1	EPBMFT5-D024H	93373
AF10167-12B1	EPBMFN5-D013H	96315
AF10167-12B1	EPBMFN5-D016H	96999
AF10169-12B1	EPBMWN5-A028H	96181
AF10170-12B1	EPBMWN4-A025H	91852
AF10171-12B1	EPBMWN4-A012H	96882
AF10172-12B1	EPBMWN4-A011H	96418
AF10173-12B1	EPBMWN3-A016H	93176
AF10174-12B1	EPBMWN5-V005H	93291
AF10175-12B1	EPBMWN3-V009H	96875
AF10176-12B1	EPBMWN3-A021H	93365
AF10178-12B1	EPBMFN5-D033H	93804
AF10179-12B1	EPBMWT5-A004D	91831
AF10180-12B1	EPBMWN5-V004D	94183
AF10181-12B1	EPBMWT5-V012D	95034
AF10182-12B1	EPBMWN6-A001D	91743
AF10183-12B1	EPBMWT4-V003D	94395
AF10184-11B1	EPBMWN3-A017H	95114
AF10184-12B1	EPBMWN3-A017H	95114
AF10185-11B1	EPBMWN3-A001H	97106
AF10185-12B1	EPBMWN3-A001H	97106
AF10185-17B1	EPBMWN3-A001H	97106
AF10186-12B1	EPBMWT5-A003H	93842
AF10187-12B1	EPBMWT5-A004H	91200
AF10188-12B1	EPBMWT4-A009H	92423
AF10189-12B1	EPBMWT6-A001H	90144
AF10190-12B1	EPBMWT6-A006H	94034
AF10191-12B1	EPBMWN4-A033H	97034
AF10193-12B1	EPBMFN4-V026H	94497
AF10193-12B1	EPBMFN4-V010H	97588
AF10195-12B1	EPBMWT5-V021H	97091
AF10196-11B1	EPBMWN3-A023H	91067
AF10196-12B1	EPBMWN3-A023H	91067
AF10196-17B1	EPBMWN3-A023H	91067
AF10202-11B1	EPBMWT5-A006D	91258
AF10202-12B1	EPBMWT5-A006D	91258
AF10206-12B1	EPBMWT5-D012H	91007
AF10207-11B1	EPBMFN3-A028H	94128
AF10207-12B1	EPBMFN3-A028H	94128
AF10215-12B1	EPBMWN3-A007H	93658
AF10222-11B1	EPBMWN3-A015H	97380

DELPHI	→ NTK	Stock
AF10222-12B1	EPBMWN3-A015H	97380
AF10223-11B1	EPBMWN6-V004H	96070
AF10223-12B1	EPBMWN6-V004H	96070
AF10224-11B1	EPBMWN4-R010H	96431
AF10224-12B1	EPBMWN4-R010H	96431
AF10227-11B1	EPBMWN6-D030H	96504
AF10227-12B1	EPBMWN6-D030H	96504
AF10230-12B1	EPBMWT4-A008H	90627
AF10231-12B1	EPBMWN4-A019H	92343
AF10231-17B1	EPBMWN4-A019H	92343
AF10232-12B1	EPBMWT4-V002H	92668
AF10232-17B1	EPBMWT4-V002H	92668
AF10233-11B1	EPBMFT5-D036H	90481
AF10233-11B1	EPBMFT5-D016H	95579
AF10233-11B1	EPBMFT5-D003P	96835
AF10233-12B1	EPBMFT5-D036H	90481
AF10233-12B1	EPBMFT5-D016H	95579
AF10233-12B1	EPBMFT5-D003P	96835
AF10236-11B1	EPBMWT5-D017H	94348
AF10236-12B1	EPBMWT5-D017H	94348
AF10236-17B1	EPBMWT5-D017H	94348
AF10238-12B1	EPBMWN3-A022H	90965
AF10240-12B1	EPBMFT5-V017H	90311
AF10240-12B1	EPBMFT5-V001P	93006
AF10240-12B1	EPBMFT5-V007H	97257
AF10241-12B1	EPBMFT5-V029H	90502
AF10241-12B1	EPBMFT5-V001P	93006
AF10241-12B1	EPBMFT5-V007H	97257
AF10247-11B1	EPBMFN5-D004P	93343
AF10247-12B1	EPBMFN5-D004P	93343
AF10248-12B1	EPBMFN5-D002P	91609
AF10248-12B1	EPBMFN5-D003H	95299
AF10249-12B1	EPBMFN5-D018H	91462
AF10249-12B1	EPBMFN5-D002P	91609
AF10250-12B1	EPBMFN5-D002P	91609
AF10250-12B1	EPBMFN5-D013H	96315
AF10251-12B1	EPBMFN5-D002P	91609
AF10251-12B1	EPBMFN5-D002H	91692
AF10254-12B1	EPBMWT4-A001D	95860
AF10255-12B1	EPBMWT4-A001D	95860
AF10256-12B1	EPBMFT6-A026H	93281
AF10257-12B1	EPBMFT5-D038H	96961
AF10258-12B1	EPBMFN5-D002P	91609
AF10258-12B1	EPBMFN5-D005H	92204
AF10259-12B1	EPBMFN5-D002P	91609
AF10259-12B1	EPBMFN5-D025H	94062
AF10260-12B1	EPBMFN5-D002P	91609
AF10260-12B1	EPBMFN5-D019H	95991
AF10261-12B1	EPBMFN5-D002P	91609
AF10261-12B1	EPBMFN5-D012H	96277
AF10262-12B1	EPBMFN5-D021H	90140
AF10263-12B1	EPBMFT5-D005P	90557





DELPHI	→ NTK	Stock
AF10263-12B1	EPBMFT5-D024H	93373
AF10263-12B1	EPBMFN5-D013H	96315
AF10265-12B1	EPBMFN5-D002P	91609
AF10265-12B1	EPBMFN5-D016H	96999
AF10266-12B1	EPBMFN5-D002P	91609
AF10266-12B1	EPBMFN5-D023H	97946
AF10267-12B1	EPBMFN5-D015H	90376
AF10267-12B1	EPBMFN5-D002P	91609
AF10269-12B1	EPBMFT5-V017H	90311
AF10269-12B1	EPBMFT5-V001P	93006
AF10270-12B1	EPBMFT5-V001P	93006
AF10270-12B1	EPBMFT5-V007H	97257
AF10272-12B1	EPBMFT5-V001P	93006
AF10272-12B1	EPBMFT5-V007H	97257
AF10274-12B1	EPBMFT5-V017H	90311
AF10274-12B1	EPBMFT5-V001P	93006
AF10275-12B1	EPBMFT5-V029H	90502
AF10275-12B1	EPBMFT5-V001P	93006
AF10277-12B1	EPBMFT5-D036H	90481
AF10277-12B1	EPBMFT5-D016H	95579
AF10277-12B1	EPBMFT5-D003P	96835
AF10278-12B1	EPBMFT5-V017H	90311
AF10278-12B1	EPBMFT5-V001P	93006
AF10279-12B1	EPBMFT5-V033H	95261
AF10280-12B1	EPBMFT5-V001P	93006
AF10280-12B1	EPBMFT5-V010H	96310
AF10281-12B1	EPBMFT5-V001P	93006
AF10281-12B1	EPBMFT5-V019H	96039
AF10282-12B1	EPBMFT5-D009H	95803
AF10282-12B1	EPBMFT5-D003P	96835
AF10282-12B1	EPBMFT5-D041H	97661
AF10283-12B1	EPBMFT5-D060H	95878
AF10284-12B1	EPBMFT5-V001P	93006
AF10284-12B1	EPBMFT5-V007H	97257
AF10285-12B1	EPBMFT5-D012H	93496
AF10286-12B1	EPBMFT5-V001P	93006
AF10286-12B1	EPBMFT5-V008H	93715
AF10287-12B1	EPBMFT5-V001P	93006
AF10287-12B1	EPBMFN5-V032H	95044
AF10287-12B1	EPBMFT5-V021H	95278
AF10288-12B1	EPBMFT5-V013H	96559
AF10289-12B1	EPBMFT5-V039H	90466
AF10289-12B1	EPBMFT5-V001P	93006
AF10291-12B1	EPBMFT5-V001P	93006
AF10291-12B1	EPBMFT5-V035H	94119
AF10292-12B1	EPBMFT5-V022H	93863
AF10296-12B1	EPBMFT5-D043H	90272
AF10296-12B1	EPBMFT5-D003P	96835
AF10297-12B1	EPBMFT5-V001P	93006
AF10297-12B1	EPBMFT5-V007H	97257
AF10298-12B1	EPBMFT5-D015H	92304
AF10298-12B1	EPBMFT5-V001P	93006

DELPHI	→ NTK	Stock
AF10299-12B1	EPBMWT4-D014H	93236
AF10300-12B1	EPBMFT5-D005P	90557
AF10301-12B1	EPBMFT5-D005P	90557
AF10301-17B1	EPBMFT5-D005P	90557
AF10302-12B1	EPBMFT5-V010H	96310
AF10303-12B1	EPBMFN4-D011H	94586
AF10304-12B1	EPBMFT5-D018H	96224
AF10304-12B1	EPBMFT5-D003P	96835
AF10304-17B1	EPBMFT5-D018H	96224
AF10304-17B1	EPBMFT5-D003P	96835
AF10305-12B1	EPBMFT5-D025H	90977
AF10305-12B1	EPBMFT5-D003P	96835
AF10305-17B1	EPBMFT5-D025H	90977
AF10305-17B1	EPBMFT5-D003P	96835
AF10307-12B1	EPBMFT5-V017H	90311
AF10347-12B1	EPBMFT5-V002D	97692
AF10360-12B1	EPBMFT5-V027H	94616
AF10361-12B1	EPBMFT5-D034H	96295
AF10363-12B1	EPBMFT5-V020H	90244
AF10364-12B1	EPBMFT5-V055H	91808
AF10364-12B1	EPBMFT5-V001P	93006
AF10364-12B1	EPBMFT5-V030H	96975
AF10365-12B1	EPBMFN4-D014H	92888
AF10366-12B1	EPBMFN5-D004P	93343
AF10367-12B1	EPBMWT6-A007H	93605
AF10369-12B1	EPBMFT6-A044H	92490
AF10370-12B1	EPBMWT5-A005H	93383
AF10371-12B1	EPBMFN5-A029H	90647
AF10372-12B1	EPBMWN4-A002D	91111
AF10373-12B1	EPBMFT5-A052H	95671
AF10374-12B1	EPBMWT4-V002D	95695
AF10375-12B1	EPBMFT5-V001P	93006
AF10375-12B1	EPBMFT5-V031H	97525
AF10376-12B1	EPBMFN4-A037H	94866
AF10377-12B1	EPBMWT5-A014D	90205
AF10377-12B1	EPBMWT5-A009D	97997
AF10378-12B1	EPBMFN4-V020H	90971
AF10380-12B1	EPBMWN4-V002H	92462
AF10386-11B1	EPBMFN5-D021H	90140
AF10390-12B1	EPBMFN4-D009H	96113
AF10391-12B1	EPBMFT5-V002H	97685
AF10392-12B1	EPBMFN4-V007H	93735
AF10393-12B1	EPBMFT5-V006H	94366
AF10395-12B1	EPBMFT5-V005H	93645
AF10396-12B1	EPBMFN4-D004H	91534
AF10397-11B1	EPBMFN4-V008H	95035
AF10397-12B1	EPBMFN4-V008H	95035
AF10398-12B1	EPBMFT5-T011H	92630
AF10399-12B1	EPBMFN4-V017H	96226
AF10400-12B1	EPBMFT4-V004H	90957
AF10401-12B1	EPBMWN5-D003H	92791
AF10403-12B1	EPBMFN4-V017H	96226





Industry

DELPHI	→ NTK	Stock
AF10404-12B1	EPBMFT4-V048H	95493
AF10405-12B1	EPBMFT6-V046H	95763
AF10406-12B1	EPBMWT5-A025H	93777
AF10407-12B1	EPBMFN5-D001H	95207
AF10408-12B1	EPBMFT5-D040H	97032
AF10409-12B1	EPBMFT5-D014H	95484
AF10410-12B1	EPBMFT5-T003H	91493
AF10411-12B1	EPBMFT5-V001P	93006
AF10411-12B1	EPBMFT5-V021H	95278
AF10415-12B1	EPBMFN5-A038H	93095
AF10432-12B1	EPBMWT4-V003D	94395
AF10480-12B1	EPBMWT5-A027H	96756
AF10494-12B1	EPBMWN3-A020H	92225
AF10496-12B1	EPBMWT5-A014D	90205
AF10496-12B1	EPBMWT5-A011D	92781
AF10499-12B1	EPBMWN5-D014H	96884
AF10502-12B1	EPBMWT5-D020H	97934
AF10510-12B1	EPBMWN5-D027H	91976
AF10526-12B1	EPBMFT5-D056H	90827
AF10584-11B1	EPBMFT5-D003P	96835
AF10584-12B1	EPBMFT5-D003P	96835
AF10625-12B1	EPBMFT5-V001P	93006
AF10626-12B1	EPBMFN4-V026H	94497
AF10626-12B1	EPBMFN4-V010H	97588
DENSO	→ NTK	Stock
DMA-0108	EPBMWT5-A014D	90205
DMA-0109	EPBMWT5-A014D	90205
DMA-0112	EPBMWT5-A014D	90205
DMA-0113	EPBMWT5-A014D	90205
DMA-0109	EPBMWT5-A011D	92781
DMA-0110	EPBMWT5-A006D	91258
DMA-0111	EPBMFT5-V002D	97692
DMA-0112	EPBMWT5-A009D	97997
DMA-0113	EPBMWT5-A005D	93145
DMA-0200	EPBMWT4-D014H	93236
DMA-0201	EPBMWN3-A022H	90965
DMA-0202	EPBMWN3-A016H	93176
DMA-0203	EPBMFN5-V005D	90496
DMA-0204	EPBMWN5-V005H	93291
DMA-0205	EPBMWN3-V031H	90825
DMA-0206	EPBMWN5-D014H	96884
DMA-0207	EPBMWN3-A021H	93365
DMA-0209	EPBMWN3-A007H	93658
DMA-0210	EPBMFN5-D033H	93804
DMA-0218	EPBMWT5-V012D	95034
DMA-0219	EPBMWT5-A004D	91831
DMA-0220	EPBMWT4-A001D	95860
DMA-0221	EPBMWT4-V002D	95695
EPS	→ NTK	Stock
1.991.005	EPBMFN4-D011H	94586
1.991.017	EPBMFT5-V001P	93006
1.991.017	EPBMFT5-V008H	93715

EPS	→ NTK	Stock
1.991.017	EPBMFT5-V037H	95360
1.991.031	EPBMFT5-V039H	90466
1.991.031	EPBMFT5-V001P	93006
1.991.034	EPBMFT5-V001P	93006
1.991.034	EPBMFT5-V008H	93715
1.991.038	EPBMFN5-D002P	91609
1.991.038	EPBMFT5-V001P	93006
1.991.038	EPBMFT5-V008H	93715
1.991.038	EPBMFT5-V007H	97257
1.991.064	EPBMFT5-D025H	90977
1.991.064	EPBMFT5-D003P	96835
1.991.076	EPBMFT5-D043H	90272
1.991.076	EPBMFT5-D003P	96835
1.991.088	EPBMFT5-V001P	93006
1.991.088	EPBMFN5-V032H	95044
1.991.088	EPBMFT5-V021H	95278
1.991.126	EPBMFN4-D004H	91534
1.991.155	EPBMFT5-V017H	90311
1.991.155	EPBMFT5-V001P	93006
1.991.158	EPBMFT5-V029H	90502
1.991.158	EPBMFT5-V001P	93006
1.991.159	EPBMFT5-V039H	90466
1.991.159	EPBMFT5-V001P	93006
1.991.159	EPBMFT5-V007H	97257
1.991.163	EPBMWT5-A014D	90205
1.991.163	EPBMWT5-A011D	92781
1.991.163	EPBMWT5-A005D	93145
1.991.163	EPBMWT5-A009D	97997
1.991.191	EPBMFN5-D047H	91140
1.991.191	EPBMFN5-D002P	91609
1.991.191	EPBMFN5-D002H	91692
1.991.192	EPBMFN5-D015H	90376
1.991.192	EPBMFN5-D002P	91609
1.991.194	EPBMFT5-D038H	96961
1.991.212	EPBMFN5-D002P	91609
1.991.212	EPBMFN5-D025H	94062
1.991.213	EPBMFN5-D002P	91609
1.991.213	EPBMFN5-D013H	96315
1.991.214	EPBMFT5-D014H	95484
1.991.216	EPBMFN5-D002P	91609
1.991.216	EPBMFN5-D023H	97946
1.991.221	EPBMFT5-D005P	90557
1.991.222	EPBMFN5-D021H	90140
1.991.223	EPBMFT5-D005P	90557
1.991.223	EPBMFT5-D024H	93373
1.991.223	EPBMFN5-D013H	96315
1.991.257	EPBMFT5-V017H	90311
1.991.264	EPBMFT5-V017H	90311
1.991.264	EPBMFT5-V001P	93006
1.991.266	EPBMFT5-V055H	91808
1.991.266	EPBMFT5-V001P	93006
1.991.266	EPBMFT5-V030H	96975





EPS	→ NTK	Stock
1.991.276	EPBMFN4-V026H	94497
1.991.276	EPBMFN4-V010H	97588
1.991.284	EPBMFN5-D002P	91609
1.991.284	EPBMFN5-D005H	92204
1.991.285	EPBMFT5-V001P	93006
1.991.285	EPBMFT5-V007H	97257
1.991.289	EPBMFT5-V001P	93006
1.991.289	EPBMFT5-V010H	96310
1.991.290	EPBMFT5-V010H	96310
1.991.293	EPBMFN4-V020H	90971
1.991.298	EPBMFT5-A001H	93740
1.991.299	EPBMFN4-V017H	96226
1.991.300	EPBMFT5-V020H	90244
1.991.301	EPBMWT4-A009H	92423
1.991.302	EPBMWT4-A011H	90069
1.991.303	EPBMWT4-A011H	90069
1.991.303	EPBMWT4-A008H	90627
1.991.311	EPBMFT5-V033H	95261
1.991.315	EPBMFT5-V022H	93863
1.991.325	EPBMFN5-D002P	91609
1.991.325	EPBMFN5-D005H	92204
1.991.329	EPBMFT5-D040H	97032
1.991.331	EPBMFT5-D034H	96295
1.991.332	EPBMFT5-V001P	93006
1.991.332	EPBMFT5-V021H	95278
1.991.341	EPBMFT5-V006H	94366
1.991.348	EPBMFN4-D009H	96113
1.991.354	EPBMFT5-D018H	96224
1.991.354	EPBMFT5-D003P	96835
1.991.355	EPBMFT5-V027H	94616
1.991.357	EPBMFN5-D001H	95207
1.991.358	EPBMFT4-D050H	94911
1.991.359	EPBMFN4-D014H	92888
1.991.361	EPBMFT6-V046H	95763
1.991.363	EPBMFT6-A049H	93243
1.991.364	EPBMWT6-A007H	93605
1.991.372	EPBMFT5-V005H	93645
1.991.376	EPBMFT5-V002H	97685
1.991.378	EPBMFT5-V053H	95935
1.991.379	EPBMFT5-V013H	96559
1.991.380	EPBMFT5-D005P	90557
1.991.388	EPBMWT6-V013H	92412
1.991.413	EPBMFT4-V004H	90957
1.991.438	EPBMFT5-T003H	91493
1.991.439	EPBMFN5-D002P	91609
1.991.439	EPBMFN5-D016H	96999
1.991.440	EPBMFT5-D036H	90481
1.991.440	EPBMFT5-D016H	95579
1.991.440	EPBMFT5-D003P	96835
1.991.441	EPBMFN5-D002P	91609
1.991.441	EPBMFN5-D012H	96277
1.991.442	EPBMFT5-D009H	95803

EPS	→ NTK	Stock
1.991.442	EPBMFT5-D003P	96835
1.991.443	EPBMFN5-D004P	93343
1.991.445	EPBMFT5-V001P	93006
1.991.445	EPBMFT5-V035H	94119
1.991.446	EPBMFN4-V008H	95035
1.991.448	EPBMWT4-A022H	93854
1.991.449	EPBMWT3-D024H	91171
1.991.454	EPBMWT4-A019H	94808
1.991.465	EPBMFT5-T011H	92630
1.991.483	EPBMFT4-V061H	94528
1.991.492	EPBMFT5-V001P	93006
1.991.492	EPBMFT5-V021H	95278
1.991.499	EPBMFT5-D047H	97067
1.991.509	EPBMFN5-D002P	91609
1.991.509	EPBMFN5-D003H	95299
1.991.556	EPBMFN4-V007H	93735
ERA	→ NTK	Stock
558001	EPBMFN5-D002P	91609
558001	EPBMFN5-D005H	92204
558002	EPBMWT4-V002H	92668
558003	EPBMWT6-A001H	90144
558004	EPBMWT5-A003H	93842
558005	EPBMWT5-A004H	91200
558006	EPBMWN4-A019H	92343
558007	EPBMFT5-V001P	93006
558008	EPBMWN4-A026H	97860
558009	EPBMWN4-A025H	91852
558010	EPBMWN4-D018H	96313
558011	EPBMWN4-A011H	96418
558012	EPBMWT4-D014H	93236
558013	EPBMWN4-A012H	96882
558014	EPBMWN3-A016H	93176
558015	EPBMWT6-A006H	94034
558016	EPBMFT5-V013H	96559
558017	EPBMWT5-D012H	91007
558018	EPBMFT5-V017H	90311
558020	EPBMFT5-V010H	96310
558021	EPBMFT5-V055H	91808
558021	EPBMFT5-V001P	93006
558021	EPBMFT5-V030H	96975
558022	EPBMWN4-A033H	97034
558023	EPBMWT5-A005H	93383
558024	EPBMFT5-V017H	90311
558024	EPBMFT5-V001P	93006
558025	EPBMWN5-D014H	96884
558026	EPBMWN3-A022H	90965
558028	EPBMWN5-A028H	96181
558035	EPBMFT5-A001H	93740
558037	EPBMWT4-A009H	92423
558038	EPBMFT5-D005P	90557
558039	EPBMFT5-D005P	90557
558039	EPBMFN5-D002P	91609





Industry

ERA	→ NTK	Stock
558039	EPBMFT5-D024H	93373
558039	EPBMFN5-D013H	96315
558040	EPBMWN3-A021H	93365
558041	EPBMWN4-A002D	91111
558042	EPBMFN5-D002P	91609
558042	EPBMFN5-D012H	96277
558043	EPBMFN5-D021H	90140
558044	EPBMFT5-V017H	90311
558044	EPBMFT5-V001P	93006
558045	EPBMWN6-D029H	90628
558046	EPBMWN4-R010H	96431
558047	EPBMWT4-A008H	90627
558048	EPBMFT5-D015H	92304
558048	EPBMFT5-V001P	93006
558049	EPBMFT5-V001P	93006
558049	EPBMFT5-V019H	96039
558050	EPBMFT6-A026H	93281
558051	EPBMWN6-A001D	91743
558052	EPBMWT4-A001D	95860
558053	EPBMWN4-V002H	92462
558054	EPBMFN5-D015H	90376
558054	EPBMFN5-D002P	91609
558055	EPBMFT5-V017H	90311
558055	EPBMFT5-V001P	93006
558056	EPBMFT5-V001P	93006
558056	EPBMFT5-V007H	97257
558057	EPBMFT5-D009H	95803
558057	EPBMFT5-D003P	96835
558058	EPBMWN3-A015H	97380
558059	EPBMFN4-A035H	97899
558060	EPBMWN3-A001H	97106
558061	EPBMFN5-D004P	93343
558062	EPBMFT5-D012H	93496
558063	EPBMFT5-V010H	96310
558064	EPBMWT4-A011H	90069
558065	EPBMFT5-V001P	93006
558065	EPBMFT5-V007H	97257
558066	EPBMFN4-V026H	94497
558066	EPBMFN4-V010H	97588
558069	EPBMFT5-D023H	93770
558069	EPBMFT5-D003P	96835
558071	EPBMFN5-D033H	93804
558072	EPBMFT5-V029H	90502
558072	EPBMFT5-V001P	93006
558073	EPBMFN5-D002P	91609
558073	EPBMFN5-D002H	91692
558074	EPBMFT5-V001P	93006
558074	EPBMFT5-V007H	97257
558075	EPBMFT5-D025H	90977
558075	EPBMFT5-D003P	96835
558076	EPBMFT5-V039H	90466
558076	EPBMFT5-V001P	93006

ERA	→ NTK	Stock
558077	EPBMFN4-D040H	96545
558078	EPBMFT5-V001P	93006
558080	EPBMFT5-V001P	93006
558081	EPBMFT5-V017H	90311
558081	EPBMFT5-V001P	93006
558082	EPBMFT5-V001P	93006
558082	EPBMFT5-V007H	97257
558083	EPBMFN5-A029H	90647
558084	EPBMFT5-D036H	90481
558084	EPBMFT5-D016H	95579
558084	EPBMFT5-D003P	96835
558085	EPBMFT5-D023H	93770
558085	EPBMFT5-D003P	96835
558086	EPBMWN3-V031H	90825
558087	EPBMFN5-V005D	90496
558088	EPBMFT5-A052H	95671
558089	EPBMWN3-A001H	97106
558090	EPBMFT5-D005P	90557
558090	EPBMFN5-D018H	91462
558090	EPBMFN5-D002P	91609
558090	EPBMFT5-D028H	93297
558091	EPBMFN5-D002P	91609
558091	EPBMFN5-D016H	96999
558092	EPBMFT5-D005P	90557
558093	EPBMFT5-D005P	90557
558093	EPBMFT5-D032H	91598
558093	EPBMFT5-D045H	95253
558094	EPBMFT5-D009H	95803
558094	EPBMFT5-D060H	95878
558094	EPBMFT5-D003P	96835
558094	EPBMFT5-D041H	97661
558095	EPBMFT5-V001P	93006
558095	EPBMFT5-V007H	97257
558096	EPBMFT5-V033H	95261
558097	EPBMFT6-A044H	92490
558098	EPBMFN5-D004P	93343
558099	EPBMWN5-V005H	93291
558102	EPBMWN3-A007H	93658
558104	EPBMWN3-A017H	95114
558106	EPBMWT5-D017H	94348
558107	EPBMWN5-D003H	92791
558108	EPBMFN5-D002P	91609
558108	EPBMFN5-D003H	95299
558109	EPBMFN5-D002P	91609
558109	EPBMFN5-D016H	96999
558110	EPBMFN5-D002P	91609
558110	EPBMFN5-D023H	97946
558111	EPBMFT5-D018H	96224
558111	EPBMFT5-D003P	96835
558112	EPBMFT5-D043H	90272
558112	EPBMFT5-D003P	96835
558113	EPBMWT4-V002D	95695





ERA	→ NTK	Stock
558118	EPBMWT4-V003D	94395
558119	EPBMFT5-V017H	90311
558122	EPBMFT5-V008H	93715
558124	EPBMFT5-V022H	93863
558126	EPBMFT5-V017H	90311
558127	EPBMFN4-V026H	94497
558127	EPBMFN4-V010H	97588
558128	EPBMFT5-T062H	91666
558128	EPBMFT5-T001D	94095
558129	EPBMFN4-A037H	94866
558130	EPBMFT5-D005P	90557
558130	EPBMFT5-D024H	93373
558131	EPBMFT5-V027H	94616
558132	EPBMFN5-D004P	93343
558133	EPBMFN4-D011H	94586
558135	EPBMFT5-V020H	90244
558137	EPBMFT5-V001P	93006
558137	EPBMFT5-V010H	96310
558138	EPBMFT4-V004H	90957
558138	EPBMFN4-V017H	96226
558139	EPBMFT4-V004H	90957
558141	EPBMFN5-D002P	91609
558141	EPBMFN5-D019H	95991
558142	EPBMFN5-D001H	95207
558143	EPBMWT5-A014D	90205
558143	EPBMWT5-A011D	92781
558144	EPBMFT5-V002H	97685
558145	EPBMWT5-A014D	90205
558145	EPBMWT5-A005D	93145
558146	EPBMFT5-T011H	92630
558147	EPBMFT5-T003H	91493
558148	EPBMWN3-A020H	92225
558149	EPBMWN3-A023H	91067
558150	EPBMWT5-D020H	97934
558152	EPBMWN6-D030H	96504
558153	EPBMWN6-V004H	96070
558154	EPBMFN4-V020H	90971
558157	EPBMFN5-D002P	91609
558157	EPBMFN5-D025H	94062
558158	EPBMWT5-A014D	90205
558159	EPBMWN5-V004D	94183
558160	EPBMWT5-V012D	95034
558162	EPBMFT5-V001P	93006
558162	EPBMFT5-V042H	94057
558162	EPBMFN5-V032H	95044
558162	EPBMFT5-V021H	95278
558165	EPBMFN4-D014H	92888
558166	EPBMWN3-V009H	96875
558167	EPBMWT6-A007H	93605
558168	EPBMWT5-V023H	95103
558171	EPBMFT6-V046H	95763
558172	EPBMFT6-A049H	93243

ERA	→ NTK	Stock
558173	EPBMFT4-D050H	94911
558175	EPBMFT5-V001P	93006
558175	EPBMFT5-V008H	93715
558176	EPBMWT5-V021H	97091
558177	EPBMFT4-V048H	95493
558182	EPBMFT5-V002D	97692
558183	EPBMWT5-A014D	90205
558183	EPBMWT5-A009D	97997
558185	EPBMFN3-A028H	94128
558190	EPBMFN5-V001D	95368
558191	EPBMFT5-T011H	92630
558196	EPBMFN4-V031H	96741
558199	EPBMFT5-V001P	93006
558199	EPBMFT5-V021H	95278
558202	EPBMWT6-V013H	92412
558204	EPBMWT5-D012H	91007
558205	EPBMFT5-V005H	93645
558206	EPBMFT5-V005H	93645
558208	EPBMFT5-V053H	95935
558213	EPBMFT5-V017H	90311
558213	EPBMFT5-V001P	93006
558214	EPBMFT5-V006H	94366
558215	EPBMFT5-D009H	95803
558215	EPBMFT5-D003P	96835
558216	EPBMFT5-D034H	96295
558217	EPBMFT5-V001P	93006
558217	EPBMFT5-V035H	94119
558218	EPBMFN4-V007H	93735
558220	EPBMFT5-V055H	91808
558220	EPBMFT5-V030H	96975
558221	EPBMFT5-D059H	94271
558222	EPBMFT5-D005P	90557
558222	EPBMFT5-D054H	94591
558224	EPBMFT5-D005P	90557
558224	EPBMFT5-D028H	93297
558225	EPBMFN5-A038H	93095
558226	EPBMFT5-D038H	96961
558228	EPBMFT5-V035H	94119
558229	EPBMFT5-V001P	93006
558235	EPBMFN4-D014H	92888
558236	EPBMFT5-V017H	90311
558236	EPBMFN4-A039H	95306
558240	EPBMWT4-A028H	91236
558241	EPBMWT4-A022H	93854
558242	EPBMFN4-D004H	91534
558247	EPBMWT5-V013D	92480
558251	EPBMFN5-V005D	90496
558252	EPBMWT5-A025H	93777
558253	EPBMWT5-A004D	91831
558254	EPBMWT4-A026H	95537
558255	EPBMWN5-D027H	91976
558256	EPBMWT5-A027H	96756





Industry

ERA	→ NTK	Stock
558257	EPBMFT5-V017H	90311
558257	EPBMFT5-V001P	93006
558258	EPBMFN6-R030H	90274
558262	EPBMFN4-D014H	92888
558264	EPBMWT4-D018H	96715
558265	EPBMFN4-V020H	90971
558266	EPBMWT4-A011H	90069
558268	EPBMFT4-V061H	94528
558274	EPBMFT4-V004H	90957
558275	EPBMFT4-V061H	94528
558276	EPBMFT5-V001P	93006
558276	EPBMFT5-V031H	97525
558277	EPBMFN5-D002P	91609
558277	EPBMFN5-D027H	94938
558286	EPBMFN4-V008H	95035
558287	EPBMFT5-A051H	90866
558288	EPBMWN4-A024H	90997
558289	EPBMWT4-A019H	94808
558291	EPBMFT5-V029H	90502
558291	EPBMFT5-V001P	93006
558299	EPBMFT5-V008H	93715
558301	EPBMFN4-A041H	97353
558302	EPBMWT6-A001H	90144
558303	EPBMWT5-A006D	91258
558311	EPBMWN5-D003D	94436
558314	EPBMWN5-D006H	92698
558317	EPBMFN5-D004P	93343
558320	EPBMFN4-D004H	91534
558322	EPBMFT5-V001P	93006
558323	EPBMFT5-D009H	95803
558323	EPBMFT5-D003P	96835
558324	EPBMFT5-D003P	96835
558326	EPBMFN4-A044H	96776
558327	EPBMFN4-A046H	90609
558330	EPBMFT5-D047H	97067
558331	EPBMFT5-D040H	97032
558346	EPBMFT5-V002H	97685
558348	EPBMFT5-D056H	90827
558350	EPBMFN4-V017H	96226
558352	EPBMFN4-D009H	96113
558356	EPBMFN5-D015H	90376
558356	EPBMFN5-D002P	91609
558356	EPBMFN5-D002H	91692
558356	EPBMFN5-D005H	92204
558356	EPBMFN5-D025H	94062
558357	EPBMFT5-V039H	90466
558357	EPBMFT5-V001P	93006
558357	EPBMFT5-V035H	94119
558357	EPBMFN5-V032H	95044
558357	EPBMFT5-V033H	95261
558357	EPBMFT5-V019H	96039
558357	EPBMFT5-V007H	97257

ERA	→ NTK	Stock
558001A	EPBMFN5-D002P	91609
558001A	EPBMFN5-D005H	92204
558002A	EPBMWT4-V002H	92668
558003A	EPBMWT6-A001H	90144
558004A	EPBMWT5-A003H	93842
558005A	EPBMWT5-A004H	91200
558006A	EPBMWN4-A019H	92343
558007A	EPBMFT5-V001P	93006
558012A	EPBMWT4-D014H	93236
558013A	EPBMWN4-A012H	96882
558014A	EPBMWN3-A016H	93176
558015A	EPBMWT6-A006H	94034
558016A	EPBMFT5-V013H	96559
558021A	EPBMFT5-V055H	91808
558021A	EPBMFT5-V001P	93006
558021A	EPBMFT5-V030H	96975
558023A	EPBMWT5-A005H	93383
558035A	EPBMFT5-A001H	93740
558037A	EPBMWT4-A009H	92423
558038A	EPBMFT5-D005P	90557
558042A	EPBMFN5-D002P	91609
558042A	EPBMFN5-D012H	96277
558044A	EPBMFT5-V017H	90311
558044A	EPBMFT5-V001P	93006
558047A	EPBMWT4-A008H	90627
558048A	EPBMFT5-D015H	92304
558048A	EPBMFT5-V001P	93006
558049A	EPBMFT5-V001P	93006
558049A	EPBMFT5-V019H	96039
558052A	EPBMWT4-A001D	95860
558054A	EPBMFN5-D015H	90376
558054A	EPBMFN5-D002P	91609
558055A	EPBMFT5-V017H	90311
558055A	EPBMFT5-V001P	93006
558056A	EPBMFT5-V001P	93006
558056A	EPBMFT5-V007H	97257
558057A	EPBMFT5-D009H	95803
558057A	EPBMFT5-D003P	96835
558058A	EPBMWN3-A015H	97380
558060A	EPBMWN3-A001H	97106
558061A	EPBMFN5-D004P	93343
558062A	EPBMFT5-D012H	93496
558065A	EPBMFT5-V001P	93006
558065A	EPBMFT5-V007H	97257
558066A	EPBMFN4-V026H	94497
558066A	EPBMFN4-V010H	97588
558069A	EPBMFT5-D023H	93770
558069A	EPBMFT5-D003P	96835
558072A	EPBMFT5-V029H	90502
558072A	EPBMFT5-V001P	93006
558073A	EPBMFN5-D002P	91609
558073A	EPBMFN5-D002H	91692





ERA	→ NTK	Stock
558074A	EPBMFT5-V001P	93006
558074A	EPBMFT5-V007H	97257
558075A	EPBMFT5-D025H	90977
558075A	EPBMFT5-D003P	96835
558078A	EPBMFT5-V001P	93006
558083A	EPBMFN5-A029H	90647
558084A	EPBMFT5-D036H	90481
558084A	EPBMFT5-D016H	95579
558084A	EPBMFT5-D003P	96835
558085A	EPBMFT5-D023H	93770
558085A	EPBMFT5-D003P	96835
558086A	EPBMWN3-V031H	90825
558087A	EPBMFN5-V005D	90496
558089A	EPBMWN3-A001H	97106
558090A	EPBMFT5-D005P	90557
558090A	EPBMFN5-D018H	91462
558090A	EPBMFN5-D002P	91609
558090A	EPBMFT5-D028H	93297
558091A	EPBMFN5-D002P	91609
558091A	EPBMFN5-D016H	96999
558092A	EPBMFT5-D005P	90557
558093A	EPBMFT5-D005P	90557
558093A	EPBMFT5-D032H	91598
558093A	EPBMFT5-D045H	95253
558094A	EPBMFT5-D009H	95803
558094A	EPBMFT5-D060H	95878
558094A	EPBMFT5-D003P	96835
558094A	EPBMFT5-D041H	97661
558095A	EPBMFT5-V001P	93006
558095A	EPBMFT5-V007H	97257
558097A	EPBMFT6-A044H	92490
558106A	EPBMWT5-D017H	94348
558107A	EPBMWN5-D003H	92791
558108A	EPBMFN5-D002P	91609
558108A	EPBMFN5-D003H	95299
558109A	EPBMFN5-D002P	91609
558109A	EPBMFN5-D016H	96999
558110A	EPBMFN5-D002P	91609
558110A	EPBMFN5-D023H	97946
558111A	EPBMFT5-D018H	96224
558111A	EPBMFT5-D003P	96835
558112A	EPBMFT5-D043H	90272
558112A	EPBMFT5-D003P	96835
558113A	EPBMWT4-V002D	95695
558118A	EPBMWT4-V003D	94395
558128A	EPBMFT5-T062H	91666
558128A	EPBMFT5-T001D	94095
558137A	EPBMFT5-V001P	93006
558137A	EPBMFT5-V010H	96310
558138A	EPBMFN4-V017H	96226
558139A	EPBMFT4-V004H	90957
558141A	EPBMFN5-D002P	91609

ERA	→ NTK	Stock
558141A	EPBMFN5-D019H	95991
558142A	EPBMFN5-D001H	95207
558143A	EPBMWT5-A014D	90205
558143A	EPBMWT5-A011D	92781
558145A	EPBMWT5-A014D	90205
558145A	EPBMWT5-A005D	93145
558149A	EPBMWN3-A023H	91067
558152A	EPBMWN6-D030H	96504
558153A	EPBMWN6-V004H	96070
558155A	EPBMFN5-D002P	91609
558155A	EPBMFN5-D025H	94062
558162A	EPBMFT5-V001P	93006
558162A	EPBMFT5-V042H	94057
558162A	EPBMFN5-V032H	95044
558162A	EPBMFT5-V021H	95278
558166A	EPBMWN3-V009H	96875
558167A	EPBMWT6-A007H	93605
558171A	EPBMFT6-V046H	95763
558182A	EPBMFT5-V002D	97692
558183A	EPBMWT5-A014D	90205
558183A	EPBMWT5-A009D	97997
558191A	EPBMFT5-T011H	92630
558199A	EPBMFT5-V001P	93006
558199A	EPBMFT5-V021H	95278
558213A	EPBMFT5-V017H	90311
558213A	EPBMFT5-V001P	93006
558215A	EPBMFT5-D009H	95803
558215A	EPBMFT5-D003P	96835
558216A	EPBMFT5-D034H	96295
558224A	EPBMFT5-D005P	90557
558224A	EPBMFT5-D028H	93297
558230A	EPBMFT5-V001P	93006
558230A	EPBMFT5-V042H	94057
558231A	EPBMFN5-D022H	91168
558231A	EPBMFN5-D002P	91609
558232A	EPBMFT5-D005P	90557
558232A	EPBMFT5-D032H	91598
558233A	EPBMFT5-V001P	93006
558233A	EPBMFT5-V037H	95360
558234A	EPBMFT5-V039H	90466
558234A	EPBMFT5-V001P	93006
558235A	EPBMFN4-D014H	92888
558241A	EPBMWT4-A022H	93854
558242A	EPBMFN4-D004H	91534
558247A	EPBMWT5-V013D	92480
558253A	EPBMWT5-A004D	91831
558254A	EPBMWT4-A026H	95537
558265A	EPBMFN4-V020H	90971
558276A	EPBMFT5-V001P	93006
558276A	EPBMFT5-V031H	97525
558277A	EPBMFN5-D002P	91609
558277A	EPBMFN5-D027H	94938





Industry

ERA	→ NTK	Stock
558303A	EPBMWT5-A006D	91258
558347A	EPBMWT3-D024H	91171
FACET	→ NTK	Stock
10.1005	EPBMFN4-D011H	94586
10.1017	EPBMFT5-V001P	93006
10.1017	EPBMFT5-V008H	93715
10.1017	EPBMFT5-V037H	95360
10.1031	EPBMFT5-V039H	90466
10.1031	EPBMFT5-V001P	93006
10.1034	EPBMFT5-V001P	93006
10.1034	EPBMFT5-V008H	93715
10.1038	EPBMFN5-D002P	91609
10.1038	EPBMFT5-V001P	93006
10.1038	EPBMFT5-V008H	93715
10.1038	EPBMFT5-V007H	97257
10.1064	EPBMFT5-D025H	90977
10.1064	EPBMFT5-D003P	96835
10.1076	EPBMFT5-D043H	90272
10.1076	EPBMFT5-D003P	96835
10.1088	EPBMFT5-V001P	93006
10.1088	EPBMFN5-V032H	95044
10.1088	EPBMFT5-V021H	95278
10.1126	EPBMFN4-D004H	91534
10.1155	EPBMFT5-V017H	90311
10.1155	EPBMFT5-V001P	93006
10.1158	EPBMFT5-V029H	90502
10.1158	EPBMFT5-V001P	93006
10.1159	EPBMFT5-V039H	90466
10.1159	EPBMFT5-V001P	93006
10.1159	EPBMFT5-V007H	97257
10.1163	EPBMWT5-A014D	90205
10.1163	EPBMWT5-A011D	92781
10.1163	EPBMWT5-A005D	93145
10.1163	EPBMWT5-A009D	97997
10.1191	EPBMFN5-D047H	91140
10.1191	EPBMFN5-D002P	91609
10.1191	EPBMFN5-D002H	91692
10.1192	EPBMFN5-D015H	90376
10.1192	EPBMFN5-D002P	91609
10.1194	EPBMFT5-D038H	96961
10.1212	EPBMFN5-D002P	91609
10.1212	EPBMFN5-D025H	94062
10.1213	EPBMFN5-D002P	91609
10.1213	EPBMFN5-D013H	96315
10.1214	EPBMFT5-D014H	95484
10.1216	EPBMFN5-D002P	91609
10.1216	EPBMFN5-D023H	97946
10.1221	EPBMFT5-D005P	90557
10.1222	EPBMFN5-D021H	90140
10.1223	EPBMFT5-D005P	90557
10.1223	EPBMFT5-D024H	93373
10.1223	EPBMFN5-D013H	96315

FACET	→ NTK	Stock
10.1257	EPBMFT5-V017H	90311
10.1264	EPBMFT5-V017H	90311
10.1264	EPBMFT5-V001P	93006
10.1266	EPBMFT5-V055H	91808
10.1266	EPBMFT5-V001P	93006
10.1266	EPBMFT5-V030H	96975
10.1276	EPBMFN4-V026H	94497
10.1276	EPBMFN4-V010H	97588
10.1284	EPBMFN5-D002P	91609
10.1284	EPBMFN5-D005H	92204
10.1285	EPBMFT5-V001P	93006
10.1285	EPBMFT5-V007H	97257
10.1289	EPBMFT5-V001P	93006
10.1289	EPBMFT5-V010H	96310
10.1290	EPBMFT5-V010H	96310
10.1293	EPBMFN4-V020H	90971
10.1298	EPBMFT5-A001H	93740
10.1299	EPBMFN4-V017H	96226
10.1300	EPBMFT5-V020H	90244
10.1301	EPBMWT4-A009H	92423
10.1302	EPBMWT4-A011H	90069
10.1303	EPBMWT4-A011H	90069
10.1303	EPBMWT4-A008H	90627
10.1311	EPBMFT5-V033H	95261
10.1315	EPBMFT5-V022H	93863
10.1325	EPBMFN5-D002P	91609
10.1325	EPBMFN5-D005H	92204
10.1329	EPBMFT5-D040H	97032
10.1331	EPBMFT5-D034H	96295
10.1332	EPBMFT5-V001P	93006
10.1332	EPBMFT5-V021H	95278
10.1341	EPBMFT5-V006H	94366
10.1348	EPBMFN4-D009H	96113
10.1354	EPBMFT5-D018H	96224
10.1354	EPBMFT5-D003P	96835
10.1355	EPBMFT5-V027H	94616
10.1357	EPBMFN5-D001H	95207
10.1358	EPBMFT4-D050H	94911
10.1359	EPBMFN4-D014H	92888
10.1361	EPBMFT6-V046H	95763
10.1363	EPBMFT6-A049H	93243
10.1364	EPBMWT6-A007H	93605
10.1372	EPBMFT5-V005H	93645
10.1376	EPBMFT5-V002H	97685
10.1378	EPBMFT5-V053H	95935
10.1379	EPBMFT5-V013H	96559
10.1380	EPBMFT5-D005P	90557
10.1388	EPBMWT6-V013H	92412
10.1413	EPBMFT4-V004H	90957
10.1438	EPBMFT5-T003H	91493
10.1439	EPBMFN5-D002P	91609
10.1439	EPBMFN5-D016H	96999





FACET	→ NTK	Stock
10.1440	EPBMFT5-D036H	90481
10.1440	EPBMFT5-D016H	95579
10.1440	EPBMFT5-D003P	96835
10.1441	EPBMFN5-D002P	91609
10.1441	EPBMFN5-D012H	96277
10.1442	EPBMFT5-D009H	95803
10.1442	EPBMFT5-D003P	96835
10.1443	EPBMFN5-D004P	93343
10.1445	EPBMFT5-V001P	93006
10.1445	EPBMFT5-V035H	94119
10.1446	EPBMFN4-V008H	95035
10.1448	EPBMWT4-A022H	93854
10.1449	EPBMWT3-D024H	91171
10.1454	EPBMWT4-A019H	94808
10.1465	EPBMFT5-T011H	92630
10.1483	EPBMFT4-V061H	94528
10.1492	EPBMFT5-V001P	93006
10.1492	EPBMFT5-V021H	95278
10.1499	EPBMFT5-D047H	97067
10.1509	EPBMFN5-D002P	91609
10.1509	EPBMFN5-D003H	95299
10.1556	EPBMFN4-V007H	93735
FEBI	→ NTK	Stock
19372	EPBMWN6-D029H	90628
19374	EPBMFN5-D002P	91609
19374	EPBMFN5-D005H	92204
19380	EPBMFN5-D015H	90376
19380	EPBMFN5-D002P	91609
21969	EPBMFT5-D023H	93770
21969	EPBMFT5-D003P	96835
22257	EPBMFT5-V001P	93006
22257	EPBMFT5-V021H	95278
22894	EPBMFN5-D002P	91609
22894	EPBMFN5-D012H	96277
22916	EPBMFT5-D005P	90557
22918	EPBMFT5-D005P	90557
22922	EPBMFN5-D002P	91609
22922	EPBMFN5-D016H	96999
22926	EPBMFN4-A037H	94866
22928	EPBMFN5-D018H	91462
22928	EPBMFN5-D002P	91609
23877	EPBMFT5-V017H	90311
23877	EPBMFT5-V001P	93006
28337	EPBMFT5-D003P	96835
28337	EPBMFT5-D041H	97661
28338	EPBMFT5-D043H	90272
28338	EPBMFT5-D003P	96835
28339	EPBMFT5-D025H	90977
28339	EPBMFT5-D003P	96835
28340	EPBMFN5-D004P	93343
28342	EPBMFT5-D009H	95803
28342	EPBMFT5-D003P	96835

FEBI	→ NTK	Stock
28363	EPBMFN5-D004P	93343
28447	EPBMFT5-V001P	93006
28447	EPBMFT5-V031H	97525
28560	EPBMFN5-D002P	91609
28560	EPBMFN5-D012H	96277
28572	EPBMFT5-D005P	90557
28587	EPBMFN5-D002P	91609
28587	EPBMFN5-D016H	96999
28593	EPBMFN5-D018H	91462
28593	EPBMFN5-D002P	91609
28595	EPBMFT5-D005P	90557
28596	EPBMFN5-D002P	91609
28596	EPBMFN5-D005H	92204
28603	EPBMFN5-D015H	90376
28603	EPBMFN5-D002P	91609
29192	EPBMFN5-D002P	91609
29192	EPBMFN5-D003H	95299
29214	EPBMFN4-A037H	94866
29315	EPBMFT5-D018H	96224
29315	EPBMFT5-D003P	96835
29474	EPBMFN4-D040H	96545
29476	EPBMFN4-D011H	94586
29516	EPBMFT5-V027H	94616
29517	EPBMFN4-D014H	92888
29702	EPBMWN4-D018H	96313
29910	EPBMFT5-D009H	95803
29910	EPBMFT5-D003P	96835
31412	EPBMFN5-D002P	91609
31412	EPBMFN5-D002H	91692
32051	EPBMWT5-V012D	95034
32052	EPBMWT5-A014D	90205
32053	EPBMWT5-A004D	91831
33698	EPBMWT4-V002H	92668
36656	EPBMFT5-D012H	93496
36714	EPBMFT5-D036H	90481
36714	EPBMFT5-D016H	95579
36714	EPBMFT5-D003P	96835
37228	EPBMFN4-V026H	94497
37228	EPBMFN4-V010H	97588
37233	EPBMWT4-A011H	90069
37288	EPBMWT4-A008H	90627
37300	EPBMFT5-A001H	93740
37514	EPBMWT6-A001H	90144
39607	EPBMFN4-D014H	92888
40613	EPBMFT5-T001D	94095
40959	EPBMFT5-T011H	92630
43670	EPBMWT4-A009H	92423
44858	EPBMFT5-V008H	93715
45622	EPBMWT5-A003H	93842
45787	EPBMWT6-A007H	93605
47888	EPBMFT4-V004H	90957
100672	EPBMFT5-V029H	90502





Industry

FEBI	→ NTK	Stock
100672	EPBMFT5-V001P	93006
101635	EPBMWT4-A001D	95860
101636	EPBMWT4-D014H	93236
102506	EPBMWT5-A004H	91200
102549	EPBMWT4-A019H	94808
103422	EPBMFN4-V017H	96226
103430	EPBMFN4-D009H	96113
103431	EPBMFT5-D034H	96295
103495	EPBMFN4-D004H	91534
103511	EPBMFN4-V020H	90971
103512	EPBMFN5-A038H	93095
103575	EPBMFT4-V061H	94528
104450	EPBMWT6-A006H	94034
104591	EPBMFT5-V001P	93006
104591	EPBMFT5-V010H	96310
104592	EPBMFT5-V001P	93006
104592	EPBMFT5-V007H	97257
105762	EPBMWN4-A024H	90997
105769	EPBMWT4-A028H	91236
105776	EPBMWN3-V009H	96875
105777	EPBMFT5-V006H	94366
105846	EPBMWT4-A026H	95537
105908	EPBMWT4-V003D	94395
105909	EPBMWT4-V002D	95695
105910	EPBMWN6-A001D	91743
106069	EPBMFT6-V046H	95763
106261	EPBMWN5-D003H	92791
106521	EPBMFT6-A044H	92490
108946	EPBMFT6-A026H	93281
108947	EPBMWN4-A002D	91111
HERTH&BUSS JAKOPARTS	→ NTK	Stock
J5680302	EPBMFT5-V017H	90311
J5680307	EPBMFT5-V055H	91808
J5680307	EPBMFT5-V001P	93006
J5680307	EPBMFT5-V030H	96975
J5680310	EPBMFT5-V010H	96310
J5680501	EPBMFT5-V029H	90502
J5680502	EPBMFT5-V017H	90311
J5681007	EPBMFT5-V001P	93006
J5681007	EPBMFT5-V042H	94057
J5682000	EPBMWT5-A014D	90205
J5682003	EPBMWT5-A014D	90205
J5682004	EPBMWT5-A014D	90205
J5682010	EPBMWT5-A014D	90205
J5683000	EPBMWT5-A014D	90205
J5680303	EPBMFT5-V002H	97685
J5680304	EPBMWT5-D012H	91007
J5680308	EPBMFT5-V005H	93645
J5680309	EPBMFN3-A028H	94128
J5680311	EPBMWN3-A017H	95114
J5680313	EPBMFT5-V053H	95935
J5680314	EPBMWN3-A001H	97106

HERTH&BUSS JAKOPARTS	→ NTK	Stock
J5680900	EPBMFN4-V026H	94497
J5680900	EPBMFN4-V010H	97588
J5681000	EPBMFN5-V005D	90496
J5681001	EPBMFT5-A063H	91029
J5681002	EPBMWN3-V031H	90825
J5681004	EPBMWN5-V005H	93291
J5681005	EPBMFN5-V005D	90496
J5681008	EPBMWT6-A007H	93605
J5681010	EPBMFT5-A052H	95671
J5681011	EPBMFT6-A049H	93243
J5681012	EPBMWT6-A001H	90144
J5682000	EPBMWT5-A011D	92781
J5682004	EPBMWT5-A009D	97997
J5682006	EPBMWT5-A006D	91258
J5682008	EPBMWT5-A004D	91831
J5683000	EPBMWT5-A005D	93145
J5683003	EPBMFT5-A001H	93740
J5684001	EPBMWN5-V004D	94183
J5685007	EPBMWT4-A008H	90627
J5685008	EPBMFT5-V002D	97692
J5688000	EPBMWT5-A003H	93842
HELLA	→ NTK	Stock
8ET 009 142-001	EPBMWT6-A001H	90144
8ET 009 142-011	EPBMWN3-A020H	92225
8ET 009 142-021	EPBMWN3-A001H	97106
8ET 009 142-031	EPBMWT4-V002H	92668
8ET 009 142-041	EPBMWN4-A033H	97034
8ET 009 142-051	EPBMWN3-A001H	97106
8ET 009 142-061	EPBMWN4-R010H	96431
8ET 009 142-081	EPBMWN4-A019H	92343
8ET 009 142-101	EPBMWT5-A003H	93842
8ET 009 142-111	EPBMWT4-A009H	92423
8ET 009 142-121	EPBMFT6-A049H	93243
8ET 009 142-131	EPBMWT6-A007H	93605
8ET 009 142-141	EPBMWT5-A004H	91200
8ET 009 142-151	EPBMWT5-D020H	97934
8ET 009 142-161	EPBMWN4-A012H	96882
8ET 009 142-171	EPBMWN4-A011H	96418
8ET 009 142-181	EPBMWN4-A025H	91852
8ET 009 142-201	EPBMWN5-A028H	96181
8ET 009 142-211	EPBMWN3-A022H	90965
8ET 009 142-241	EPBMWN4-D018H	96313
8ET 009 142-251	EPBMWN3-A016H	93176
8ET 009 142-261	EPBMWT4-D014H	93236
8ET 009 142-281	EPBMWN4-A002D	91111
8ET 009 142-291	EPBMFT6-A026H	93281
8ET 009 142-321	EPBMWT5-A005H	93383
8ET 009 142-331	EPBMWT5-D017H	94348
8ET 009 142-341	EPBMWN3-A015H	97380
8ET 009 142-351	EPBMWN5-D003H	92791
8ET 009 142-361	EPBMWN3-A021H	93365
8ET 009 142-371	EPBMWT5-V021H	97091





HELLA	→ NTK	Stock
8ET 009 142-381	EPBMWN3-A023H	91067
8ET 009 142-391	EPBMWT6-A006H	94034
8ET 009 142-411	EPBMWN3-A007H	93658
8ET 009 142-421	EPBMWT4-A011H	90069
8ET 009 142-431	EPBMWT4-A008H	90627
8ET 009 142-441	EPBMWN3-A017H	95114
8ET 009 142-451	EPBMWN5-D014H	96884
8ET 009 142-461	EPBMFN3-A028H	94128
8ET 009 142-511	EPBMFT5-V017H	90311
8ET 009 142-511	EPBMFT5-V001P	93006
8ET 009 142-541	EPBMFT5-A001H	93740
8ET 009 142-551	EPBMFT6-V046H	95763
8ET 009 142-561	EPBMFN5-D002P	91609
8ET 009 142-561	EPBMFN5-D005H	92204
8ET 009 142-571	EPBMFN5-D002P	91609
8ET 009 142-571	EPBMFN5-D002H	91692
8ET 009 142-581	EPBMWT4-A001D	95860
8ET 009 142-591	EPBMWN6-A001D	91743
8ET 009 142-601	EPBMFT4-D050H	94911
8ET 009 142-611	EPBMWN5-D003D	94436
8ET 009 142-651	EPBMFT6-A044H	92490
8ET 009 142-661	EPBMWN6-D030H	96504
8ET 009 142-671	EPBMFT5-V017H	90311
8ET 009 142-671	EPBMFT5-V001P	93006
8ET 009 142-691	EPBMFT5-V039H	90466
8ET 009 142-691	EPBMFT5-V001P	93006
8ET 009 142-701	EPBMFT5-D005P	90557
8ET 009 142-711	EPBMFT5-D005P	90557
8ET 009 142-721	EPBMFT5-V013H	96559
8ET 009 142-731	EPBMFT5-V001P	93006
8ET 009 142-731	EPBMFT5-V007H	97257
8ET 009 142-741	EPBMFT5-V029H	90502
8ET 009 142-741	EPBMFT5-V001P	93006
8ET 009 142-751	EPBMWN3-V031H	90825
8ET 009 142-761	EPBMFN5-V005D	90496
8ET 009 142-771	EPBMWN5-V005H	93291
8ET 009 142-781	EPBMFN5-V005D	90496
8ET 009 142-791	EPBMFN5-D033H	93804
8ET 009 142-811	EPBMFT5-V001P	93006
8ET 009 142-811	EPBMFT5-V007H	97257
8ET 009 142-821	EPBMWT4-V002D	95695
8ET 009 142-831	EPBMWN4-V002H	92462
8ET 009 142-861	EPBMFN5-D015H	90376
8ET 009 142-861	EPBMFN5-D002P	91609
8ET 009 142-891	EPBMWT5-A014D	90205
8ET 009 142-891	EPBMWT5-A005D	93145
8ET 009 142-901	EPBMWT5-A014D	90205
8ET 009 142-901	EPBMWT5-A011D	92781
8ET 009 142-921	EPBMWT5-A014D	90205
8ET 009 142-921	EPBMWT5-A009D	97997
8ET 009 142-931	EPBMWT5-A014D	90205
8ET 009 142-931	EPBMWT5-A011D	92781

HELLA	→ NTK	Stock
8ET 009 142-951	EPBMWT5-A006D	91258
8ET 009 142-961	EPBMFT5-V002D	97692
8ET 009 142-971	EPBMWT6-V013H	92412
8ET 009 142-981	EPBMFT5-V001P	93006
8ET 009 142-981	EPBMFT5-V008H	93715
8ET 009 142-991	EPBMFT5-V001P	93006
8ET 009 142-991	EPBMFN5-V032H	95044
8ET 009 142-991	EPBMFT5-V021H	95278
8ET 009 149-001	EPBMFN5-D002P	91609
8ET 009 149-001	EPBMFN5-D025H	94062
8ET 009 149-011	EPBMFN5-D002P	91609
8ET 009 149-011	EPBMFN5-D013H	96315
8ET 009 149-021	EPBMFT5-D034H	96295
8ET 009 149-031	EPBMFN5-D002P	91609
8ET 009 149-031	EPBMFN5-D005H	92204
8ET 009 149-031	EPBMFN5-D016H	96999
8ET 009 149-041	EPBMFT5-D036H	90481
8ET 009 149-041	EPBMFT5-D016H	95579
8ET 009 149-041	EPBMFT5-D003P	96835
8ET 009 149-051	EPBMFN5-D002P	91609
8ET 009 149-051	EPBMFN5-D012H	96277
8ET 009 149-061	EPBMFT5-D009H	95803
8ET 009 149-061	EPBMFT5-D003P	96835
8ET 009 149-071	EPBMFT5-V001P	93006
8ET 009 149-071	EPBMFT5-V021H	95278
8ET 009 149-091	EPBMFT5-D043H	90272
8ET 009 149-091	EPBMFT5-D003P	96835
8ET 009 149-121	EPBMFT5-D025H	90977
8ET 009 149-121	EPBMFT5-D003P	96835
8ET 009 149-131	EPBMFN4-V026H	94497
8ET 009 149-131	EPBMFN4-V010H	97588
8ET 009 149-141	EPBMFN4-V017H	96226
8ET 009 149-151	EPBMFT5-V006H	94366
8ET 009 149-161	EPBMFN4-D009H	96113
8ET 009 149-171	EPBMFT5-V027H	94616
8ET 009 149-181	EPBMFN5-D001H	95207
8ET 009 149-191	EPBMFT5-V005H	93645
8ET 009 149-201	EPBMFT5-V002H	97685
8ET 009 149-211	EPBMFN4-V007H	93735
8ET 009 149-221	EPBMFT4-V004H	90957
8ET 009 149-231	EPBMFN5-D004P	93343
8ET 009 149-251	EPBMFN5-D021H	90140
8ET 009 149-261	EPBMFT5-D005P	90557
8ET 009 149-261	EPBMFT5-D024H	93373
8ET 009 149-261	EPBMFN5-D013H	96315
8ET 009 149-281	EPBMFN4-V020H	90971
8ET 009 149-311	EPBMWT5-A004D	91831
8ET 009 149-321	EPBMWN5-V004D	94183
8ET 009 149-341	EPBMFN4-V007H	93735
8ET 009 149-361	EPBMFN5-D002P	91609
8ET 009 149-361	EPBMFN5-D003H	95299
8ET 009 149-371	EPBMFT5-V001P	93006





Industry

HELLA	→ NTK	Stock
8ET 009 149-371	EPBMFT5-V021H	95278
8ET 009 149-381	EPBMFN4-D004H	91534
8ET 009 149-391	EPBMFT5-V055H	91808
8ET 009 149-391	EPBMFT5-V001P	93006
8ET 009 149-391	EPBMFT5-V030H	96975
8ET 009 149-401	EPBMFT5-V010H	96310
8ET 009 149-411	EPBMFT5-V022H	93863
8ET 009 149-421	EPBMFT5-D018H	96224
8ET 009 149-421	EPBMFT5-D003P	96835
8ET 009 149-431	EPBMFN4-D014H	92888
8ET 009 149-441	EPBMFN4-V008H	95035
8ET 009 149-451	EPBMFT5-T011H	92630
8ET 009 149-461	EPBMFN4-D011H	94586
8ET 009 149-471	EPBMWT4-V003D	94395
8ET 009 149-481	EPBMFT5-V010H	96310
8ET 009 149-521	EPBMWT5-V013D	92480
8ET 009 149-561	EPBMWT4-A026H	95537
8ET 009 149-571	EPBMWN5-D006H	92698
8ET 009 149-581	EPBMWN5-D027H	91976
8ET 009 149-591	EPBMWT5-A027H	96756
8ET 009 149-641	EPBMWT5-V023H	95103
8ET 009 149-651	EPBMFT5-T003H	91493
8ET 009 149-661	EPBMFN5-D002P	91609
8ET 009 149-661	EPBMFN5-D019H	95991
8ET 009 149-671	EPBMWN6-D029H	90628
8ET 358 095-011	EPBMFT5-A052H	95671
8ET 358 095-021	EPBMFT5-D015H	92304
8ET 358 095-021	EPBMFT5-V001P	93006
8ET 358 095-041	EPBMFT5-D012H	93496
8ET 358 095-051	EPBMFN5-D018H	91462
8ET 358 095-051	EPBMFN5-D002P	91609
8ET 358 095-061	EPBMWT3-D024H	91171
8ET 358 095-071	EPBMFT5-V001P	93006
8ET 358 095-071	EPBMFT5-V010H	96310
8ET 358 095-101	EPBMWT5-V012D	95034
8ET 358 095-111	EPBMFN5-D004P	93343
8ET 358 095-131	EPBMWT4-A022H	93854
8ET 358 095-141	EPBMFT5-T001D	94095
8ET 358 095-161	EPBMWT4-A019H	94808
8ET 358 095-201	EPBMFT4-V061H	94528
8ET 358 095-261	EPBMFT5-A051H	90866
8ET 358 095-301	EPBMFN4-D014H	92888
8ET 358 095-341	EPBMWT5-V010H	93933
8ET 358 095-351	EPBMWT5-D012H	91007
8ET 358 095-371	EPBMFT5-D023H	93770
8ET 358 095-371	EPBMFT5-D003P	96835
8ET 358 095-381	EPBMWT5-A025H	93777
8ET 358 095-401	EPBMFT5-D038H	96961
8ET 358 095-411	EPBMFN4-A037H	94866
HITACHI	→ NTK	Stock
135000	EPBMWN5-A028H	96181
135014	EPBMWT5-V013D	92480

HITACHI	→ NTK	Stock
135019	EPBMWN4-A025H	91852
135022	EPBMWN4-A012H	96882
135027	EPBMWN4-A011H	96418
135029	EPBMWN3-A016H	93176
135030	EPBMWT4-D014H	93236
135032	EPBMWN5-V005H	93291
135033	EPBMWN3-V009H	96875
135037	EPBMWN6-A001D	91743
135038	EPBMWT5-A014D	90205
135039	EPBMWT5-A014D	90205
135039	EPBMWT5-A009D	97997
135040	EPBMWT5-A006D	91258
135041	EPBMWT5-A014D	90205
135041	EPBMWT5-A011D	92781
135043	EPBMFT5-V002D	97692
135048	EPBMWN3-A021H	93365
135049	EPBMWN4-D018H	96313
135051	EPBMWN3-V031H	90825
135055	EPBMWN5-D014H	96884
135057	EPBMFN5-D033H	93804
135058	EPBMWT5-V013D	92480
135058	EPBMWT5-A025H	93777
135061	EPBMWT5-A004D	91831
135067	EPBMWT5-A014D	90205
135067	EPBMWT5-A005D	93145
135070	EPBMWN4-A002D	91111
135072	EPBMWN5-V004D	94183
135074	EPBMWT5-V012D	95034
135076	EPBMWT4-A026H	95537
135077	EPBMWN5-D006H	92698
135078	EPBMWN5-D027H	91976
135079	EPBMWT5-A027H	96756
135080	EPBMWT4-A028H	91236
135081	EPBMWN6-A001D	91743
135082	EPBMWN5-D003D	94436
135084	EPBMWN4-V002H	92462
135085	EPBMWN4-A024H	90997
135086	EPBMFN5-V005D	90496
135086	EPBMWN5-V005H	93291
135087	EPBMWT4-A001D	95860
135088	EPBMWT4-V002D	95695
135089	EPBMWT4-V003D	94395
135091	EPBMWN6-D029H	90628
135092	EPBMWT5-V023H	95103
135093	EPBMFN5-D004P	93343
135094	EPBMFT6-A026H	93281
135095	EPBMFN6-R030H	90274
135096	EPBMFT5-A001H	93740
135097	EPBMFN4-D011H	94586
135098	EPBMFT5-V001P	93006
135098	EPBMFT5-V058H	93155
135098	EPBMFN5-V043H	93581





HITACHI	→ NTK	Stock
135098	EPBMFT5-V008H	93715
135098	EPBMFT5-V037H	95360
135098	EPBMFT5-V007H	97257
135098	EPBMFT5-V031H	97525
135099	EPBMWT4-V002H	92668
135102	EPBMFT5-A063H	91029
135104	EPBMWT6-A001H	90144
135105	EPBMWT6-A007H	93605
135106	EPBMFT6-V046H	95763
135107	EPBMFT6-A049H	93243
135108	EPBMWT4-A019H	94808
135109	EPBMWT4-A022H	93854
135111	EPBMFN4-V026H	94497
135111	EPBMFN4-V010H	97588
135113	EPBMFN4-V017H	96226
135114	EPBMFT4-V004H	90957
135114	EPBMFN4-V017H	96226
135116	EPBMFN4-D004H	91534
135117	EPBMFT4-V061H	94528
135118	EPBMFN4-V020H	90971
135119	EPBMFT5-T011H	92630
135121	EPBMFT5-V005H	93645
135122	EPBMFN4-V010H	97588
135125	EPBMFT5-V001P	93006
135126	EPBMFT5-V006H	94366
135127	EPBMFT5-V002H	97685
135129	EPBMFN4-D009H	96113
135130	EPBMFN4-D014H	92888
135131	EPBMFT5-V027H	94616
138347	EPBMFT5-T011H	92630
138348	EPBMFT4-V004H	90957
138349	EPBMFN5-D001H	95207
138350	EPBMFN5-D015H	90376
138350	EPBMFN5-D002P	91609
138351	EPBMFN5-D002P	91609
138351	EPBMFN5-D005H	92204
138352	EPBMFT5-D005P	90557
138353	EPBMFT5-V017H	90311
138353	EPBMFT5-V001P	93006
138354	EPBMFN5-D018H	91462
138354	EPBMFN5-D002P	91609
138355	EPBMFT5-D005P	90557
138357	EPBMFT5-D043H	90272
138357	EPBMFT5-D003P	96835
138358	EPBMFT5-D003P	96835
138358	EPBMFT5-D041H	97661
138362	EPBMFT5-V001P	93006
138362	EPBMFT5-V042H	94057
138362	EPBMFN5-V032H	95044
138362	EPBMFT5-V021H	95278
138364	EPBMFT5-D005P	90557
138364	EPBMFT5-D032H	91598

HITACHI	→ NTK	Stock
138364	EPBMFT5-D045H	95253
138365	EPBMFN5-D002P	91609
138365	EPBMFN5-D012H	96277
138366	EPBMFT5-D005P	90557
138366	EPBMFT5-D024H	93373
138366	EPBMFN5-D013H	96315
138367	EPBMFT5-V001P	93006
138370	EPBMFN5-D002P	91609
138370	EPBMFN5-D016H	96999
138376	EPBMFN5-D002P	91609
138376	EPBMFN5-D013H	96315
138378	EPBMFN4-V036H	95777
138927	EPBMWT5-A005H	93383
138930	EPBMWN5-D003H	92791
138931	EPBMWN3-A001H	97106
138932	EPBMFT5-D060H	95878
138934	EPBMFT5-D038H	96961
138935	EPBMFN5-D004P	93343
138936	EPBMFN5-D004P	93343
138937	EPBMFT5-D009H	95803
138937	EPBMFT5-D003P	96835
138938	EPBMFT5-V033H	95261
138939	EPBMFT5-V029H	90502
138939	EPBMFT5-V001P	93006
138940	EPBMFT5-V017H	90311
138940	EPBMFT5-V029H	90502
138940	EPBMFT5-V001P	93006
138940	EPBMFT5-V010H	96310
138940	EPBMFT5-V007H	97257
138941	EPBMFT5-V022H	93863
138942	EPBMFT5-V010H	96310
138943	EPBMFT5-V001P	93006
138943	EPBMFT5-V021H	95278
138944	EPBMFT5-A052H	95671
138945	EPBMFN5-D022H	91168
138945	EPBMFN5-D002P	91609
138946	EPBMFT5-D023H	93770
138946	EPBMFT5-D003P	96835
138948	EPBMFT5-V001P	93006
138948	EPBMFT5-V019H	96039
138949	EPBMFN5-D004P	93343
138950	EPBMFN5-D015H	90376
138950	EPBMFN5-D002P	91609
138951	EPBMFN5-D002P	91609
138951	EPBMFN5-D005H	92204
138952	EPBMFT5-D005P	90557
138953	EPBMFT5-V017H	90311
138953	EPBMFT5-V001P	93006
138954	EPBMFN5-D018H	91462
138954	EPBMFN5-D002P	91609
138955	EPBMFT5-D005P	90557
138957	EPBMFT5-D043H	90272





Industry

HITACHI	→ NTK	Stock
138957	EPBMFT5-D003P	96835
138958	EPBMFT5-D003P	96835
138958	EPBMFT5-D041H	97661
138959	EPBMFT5-D009H	95803
138959	EPBMFT5-D003P	96835
138960	EPBMFT5-D025H	90977
138960	EPBMFT5-D003P	96835
138963	EPBMFT5-V001P	93006
138963	EPBMFT5-V021H	95278
138964	EPBMFT5-D005P	90557
138964	EPBMFT5-D032H	91598
138964	EPBMFT5-D045H	95253
138965	EPBMFN5-D002P	91609
138965	EPBMFN5-D012H	96277
138967	EPBMFT5-V001P	93006
138968	EPBMFT5-V001P	93006
138968	EPBMFT5-V007H	97257
138970	EPBMFN5-D002P	91609
138970	EPBMFN5-D016H	96999
138972	EPBMWT4-V002H	92668
138974	EPBMFT5-D023H	93770
138974	EPBMFT5-D003P	96835
138975	EPBMFN5-D002P	91609
138975	EPBMFN5-D019H	95991
138976	EPBMFN5-D002P	91609
138976	EPBMFN5-D013H	96315
138977	EPBMFN5-A029H	90647
138979	EPBMFT5-V001P	93006
138979	EPBMFT5-V007H	97257
138980	EPBMWT5-D017H	94348
138981	EPBMFT5-D012H	93496
138988	EPBMFN5-D002P	91609
138988	EPBMFN5-D025H	94062
138989	EPBMFN5-D002P	91609
138989	EPBMFN5-D003H	95299
138990	EPBMFN5-D002P	91609
138990	EPBMFN5-D002H	91692
138991	EPBMFT5-D005P	90557
138991	EPBMFT5-D028H	93297
138992	EPBMFT5-D036H	90481
138992	EPBMFT5-D016H	95579
138992	EPBMFT5-D003P	96835
138993	EPBMFT5-D034H	96295
138994	EPBMFT5-V017H	90311
138994	EPBMFT5-V001P	93006
138995	EPBMFT5-D018H	96224
138995	EPBMFT5-D003P	96835
138996	EPBMFT5-V017H	90311
138996	EPBMFT5-V001P	93006
138997	EPBMFT5-V017H	90311
138997	EPBMFT5-V001P	93006
138998	EPBMFT5-V020H	90244

HITACHI	→ NTK	Stock
2505000	EPBMWN5-A028H	96181
2505002	EPBMWN4-A026H	97860
2505014	EPBMWT5-V013D	92480
2505019	EPBMWN4-A025H	91852
2505022	EPBMWN4-A012H	96882
2505027	EPBMWN4-A011H	96418
2505029	EPBMWN3-A016H	93176
2505030	EPBMWT4-D014H	93236
2505032	EPBMWN5-V005H	93291
2505033	EPBMWN3-V009H	96875
2505037	EPBMWN6-A001D	91743
2505038	EPBMWT5-A014D	90205
2505039	EPBMWT5-A014D	90205
2505039	EPBMWT5-A009D	97997
2505040	EPBMWT5-A006D	91258
2505041	EPBMWT5-A014D	90205
2505041	EPBMWT5-A011D	92781
2505043	EPBMFT5-V002D	97692
2505047	EPBMWN3-A007H	93658
2505048	EPBMWN3-A021H	93365
2505049	EPBMWN4-D018H	96313
2505051	EPBMWN3-V031H	90825
2505055	EPBMWN5-D014H	96884
2505057	EPBMFN5-D033H	93804
2505058	EPBMWT5-A025H	93777
2505061	EPBMWT5-A004D	91831
2505067	EPBMWT5-A014D	90205
2505067	EPBMWT5-A005D	93145
2505070	EPBMWN4-A002D	91111
2505072	EPBMWN5-V004D	94183
2505074	EPBMWT5-V012D	95034
2505076	EPBMWT4-A026H	95537
2505077	EPBMWN5-D006H	92698
2505078	EPBMWN5-D027H	91976
2505079	EPBMWT5-A027H	96756
2505080	EPBMWT4-A028H	91236
2505081	EPBMWN6-A001D	91743
2505082	EPBMWN5-D003D	94436
2505084	EPBMWN4-V002H	92462
2505085	EPBMWN4-A024H	90997
2505086	EPBMFN5-V005D	90496
2505086	EPBMWN5-V005H	93291
2505087	EPBMWT4-A001D	95860
2505088	EPBMWT4-V002D	95695
2505089	EPBMWT4-V003D	94395
2505091	EPBMWN6-D029H	90628
2505092	EPBMWT5-V023H	95103
2505093	EPBMFN5-D004P	93343
2505094	EPBMFT6-A026H	93281
2505095	EPBMFN6-R030H	90274
2505096	EPBMFT5-A001H	93740
2505097	EPBMFN4-D011H	94586



HITACHI	→ NTK	Stock
2505098	EPBMFT5-V001P	93006
2505098	EPBMFT5-V058H	93155
2505098	EPBMFN5-V043H	93581
2505098	EPBMFT5-V008H	93715
2505098	EPBMFT5-V037H	95360
2505098	EPBMFT5-V007H	97257
2505098	EPBMFT5-V031H	97525
2505102	EPBMFT5-A063H	91029
2505104	EPBMWT6-A001H	90144
2505105	EPBMWT6-A007H	93605
2505106	EPBMFT6-V046H	95763
2505107	EPBMFT6-A049H	93243
2505108	EPBMWT4-A019H	94808
2505109	EPBMWT4-A022H	93854
2505111	EPBMFN4-V026H	94497
2505111	EPBMFN4-V010H	97588
2505113	EPBMFN4-V017H	96226
2505114	EPBMFT4-V004H	90957
2505114	EPBMFN4-V017H	96226
2505116	EPBMFN4-D004H	91534
2505117	EPBMFT4-V061H	94528
2505118	EPBMFN4-V020H	90971
2505119	EPBMFT5-T011H	92630
2505121	EPBMFT5-V005H	93645
2505122	EPBMFN4-V010H	97588
2505125	EPBMFT5-V001P	93006
2505126	EPBMFT5-V006H	94366
2505127	EPBMFT5-V002H	97685
2505129	EPBMFN4-D009H	96113
2505130	EPBMFN4-D004H	91534
2505130	EPBMFN4-D014H	92888
2505131	EPBMFT5-V027H	94616
2508930	EPBMWN5-D003H	92791
2508931	EPBMWN3-A001H	97106
2508932	EPBMFT5-D060H	95878
2508934	EPBMFT5-D038H	96961
2508935	EPBMFN5-D004P	93343
2508936	EPBMFN5-D004P	93343
2508937	EPBMFT5-D009H	95803
2508937	EPBMFT5-D003P	96835
2508938	EPBMFT5-V033H	95261
2508939	EPBMFT5-V029H	90502
2508939	EPBMFT5-V001P	93006
2508940	EPBMFT5-V017H	90311
2508940	EPBMFT5-V029H	90502
2508940	EPBMFT5-V001P	93006
2508940	EPBMFT5-V010H	96310
2508940	EPBMFT5-V007H	97257
2508941	EPBMFT5-V022H	93863
2508942	EPBMFT5-V010H	96310
2508943	EPBMFT5-V001P	93006
2508943	EPBMFT5-V021H	95278

HITACHI	→ NTK	Stock
2508944	EPBMFT5-A052H	95671
2508945	EPBMFN5-D022H	91168
2508945	EPBMFN5-D002P	91609
2508946	EPBMFT5-D023H	93770
2508946	EPBMFT5-D003P	96835
2508950	EPBMFN5-D015H	90376
2508950	EPBMFN5-D002P	91609
2508951	EPBMFN5-D002P	91609
2508951	EPBMFN5-D005H	92204
2508953	EPBMFT5-V017H	90311
2508953	EPBMFT5-V001P	93006
2508954	EPBMFN5-D018H	91462
2508954	EPBMFN5-D002P	91609
2508955	EPBMFT5-D005P	90557
2508957	EPBMFT5-D043H	90272
2508957	EPBMFT5-D003P	96835
2508958	EPBMFT5-D003P	96835
2508958	EPBMFT5-D041H	97661
2508959	EPBMFT5-D009H	95803
2508959	EPBMFT5-D003P	96835
2508960	EPBMFT5-D025H	90977
2508960	EPBMFT5-D003P	96835
2508963	EPBMFT5-V001P	93006
2508963	EPBMFT5-V021H	95278
2508964	EPBMFT5-D005P	90557
2508964	EPBMFT5-D032H	91598
2508964	EPBMFT5-D045H	95253
2508965	EPBMFN5-D002P	91609
2508965	EPBMFN5-D012H	96277
2508967	EPBMFT5-V001P	93006
2508968	EPBMFT5-V001P	93006
2508968	EPBMFT5-V007H	97257
2508970	EPBMFN5-D002P	91609
2508970	EPBMFN5-D016H	96999
2508972	EPBMWT4-V002H	92668
2508974	EPBMFT5-D023H	93770
2508974	EPBMFT5-D003P	96835
2508975	EPBMFN5-D002P	91609
2508975	EPBMFN5-D019H	95991
2508976	EPBMFN5-D002P	91609
2508976	EPBMFN5-D013H	96315
2508977	EPBMFN5-A029H	90647
2508979	EPBMFT5-V001P	93006
2508979	EPBMFT5-V007H	97257
2508980	EPBMWT5-D017H	94348
2508981	EPBMFT5-D012H	93496
2508988	EPBMFN5-D002P	91609
2508988	EPBMFN5-D025H	94062
2508989	EPBMFN5-D002P	91609
2508989	EPBMFN5-D003H	95299
2508990	EPBMFN5-D002P	91609
2508990	EPBMFN5-D002H	91692





Industry

HITACHI	→ NTK	Stock
2508991	EPBMFT5-D005P	90557
2508991	EPBMFT5-D028H	93297
2508992	EPBMFT5-D036H	90481
2508992	EPBMFT5-D016H	95579
2508992	EPBMFT5-D003P	96835
2508993	EPBMFT5-D034H	96295
2508994	EPBMFT5-V017H	90311
2508994	EPBMFT5-V001P	93006
2508995	EPBMFT5-D018H	96224
2508995	EPBMFT5-D003P	96835
2508996	EPBMFT5-V017H	90311
2508996	EPBMFT5-V001P	93006
2508997	EPBMFT5-V017H	90311
2508997	EPBMFT5-V001P	93006
2508998	EPBMFT5-V020H	90244
INTERMOTOR	→ NTK	Stock
19350	EPBMFN4-V008H	95035
19352	EPBMFT5-V002D	97692
19353	EPBMWT4-V003D	94395
19354	EPBMWN5-V004D	94183
19355	EPBMWT5-V012D	95034
19358	EPBMFT5-T062H	91666
19359	EPBMFN4-D009H	96113
19360	EPBMWT6-V013H	92412
19361	EPBMWN5-D006H	92698
19362	EPBMWN5-D027H	91976
19363	EPBMWN4-A024H	90997
19364	EPBMFT5-T011H	92630
19365	EPBMFT5-V006H	94366
19366	EPBMWT5-D012H	91007
19367	EPBMFT5-V029H	90502
19367	EPBMFT5-V001P	93006
19370	EPBMWT4-A011H	90069
19371	EPBMFT5-V057H	91176
19372	EPBMWN4-V032H	90737
19374	EPBMFT5-T003H	91493
19375	EPBMWT5-V015H	92930
19376	EPBMFN4-D014H	92888
19377	EPBMFT5-T001D	94095
19378	EPBMFT5-V055H	91808
19378	EPBMFT5-V030H	96975
19381	EPBMFT5-A051H	90866
19403	EPBMFN4-A039H	95306
19404	EPBMWN4-A033H	97034
19407	EPBMWN6-D029H	90628
19408	EPBMFN4-A045H	92062
19409	EPBMFN6-R030H	90274
19411	EPBMFN4-D040H	96545
19419	EPBMFN4-A041H	97353
19420	EPBMFN4-A035H	97899
19421	EPBMFN4-A044H	96776
19422	EPBMWN4-R010H	96431

INTERMOTOR	→ NTK	Stock
19423	EPBMFN4-V036H	95777
19424	EPBMFT5-V001P	93006
19425	EPBMFN6-A034H	91004
19426	EPBMWN3-A020H	92225
19430	EPBMFT5-V001P	93006
19430	EPBMFT5-V021H	95278
19432	EPBMFT5-V001P	93006
19432	EPBMFT5-V008H	93715
19433	EPBMFN5-A029H	90647
19436	EPBMFN5-D021H	90140
19437	EPBMFN4-A046H	90609
19440	EPBMFN4-A037H	94866
19441	EPBMWN5-D014H	96884
19442	EPBMFN5-D027H	94938
19443	EPBMFT5-D005P	90557
19443	EPBMFT5-D024H	93373
19443	EPBMFN5-D013H	96315
19444	EPBMFT5-V001P	93006
19445	EPBMFT5-V039H	90466
19445	EPBMFT5-V001P	93006
19448	EPBMFT5-V001P	93006
19448	EPBMFN5-V043H	93581
19450	EPBMFT5-D009H	95803
19450	EPBMFT5-D003P	96835
19451	EPBMFT5-V058H	93155
19452	EPBMFT5-V029H	90502
19454	EPBMFN4-D004H	91534
19456	EPBMFT5-D005P	90557
19456	EPBMFT5-D054H	94591
19457	EPBMFT5-V022H	93863
19458	EPBMFT5-D059H	94271
19459	EPBMFT5-V017H	90311
19459	EPBMFT5-V001P	93006
19461	EPBMFT5-V010H	96310
19462	EPBMFT5-V017H	90311
19463	EPBMWT5-D020H	97934
19466	EPBMFT5-A052H	95671
19468	EPBMWT5-D017H	94348
19471	EPBMFT5-V017H	90311
19474	EPBMWT5-V021H	97091
19475	EPBMWN3-A021H	93365
19478	EPBMFT5-D060H	95878
19482	EPBMFT6-A044H	92490
19483	EPBMFT5-V010H	96310
19486	EPBMFT5-V008H	93715
19487	EPBMFT5-V035H	94119
19488	EPBMWN3-A015H	97380
19489	EPBMWN4-D018H	96313
19494	EPBMFT5-V013H	96559
19495	EPBMFN3-A028H	94128
19496	EPBMWN5-D003H	92791
19497	EPBMFT5-V053H	95935





INTERMOTOR	→ NTK	Stock
19498	EPBMWT5-V023H	95103
19611	EPBMWT5-A014D	90205
19611	EPBMWT5-A009D	97997
19612	EPBMWT5-A004D	91831
19614	EPBMFT5-V033H	95261
19618	EPBMWT5-A014D	90205
19618	EPBMWT5-A005D	93145
19620	EPBMWT5-A014D	90205
19620	EPBMWT5-A011D	92781
19623	EPBMWN4-A011H	96418
19624	EPBMWN4-A012H	96882
19625	EPBMFT5-A001H	93740
19625	EPBMWT4-V002D	95695
19627	EPBMWN4-A002D	91111
19628	EPBMFT6-A026H	93281
19629	EPBMWN4-A025H	91852
19630	EPBMWN5-A028H	96181
19633	EPBMWT4-A008H	90627
19634	EPBMWN4-V002H	92462
19635	EPBMWN4-A026H	97860
19636	EPBMWN6-A001D	91743
19641	EPBMWT4-A009H	92423
19642	EPBMWT4-A001D	95860
19643	EPBMFT5-V001P	93006
19643	EPBMFT5-V021H	95278
19644	EPBMWN3-V031H	90825
19645	EPBMWN3-A007H	93658
19648	EPBMWT4-V002D	95695
19649	EPBMFT5-D034H	96295
19653	EPBMWT4-D014H	93236
19654	EPBMWN3-A016H	93176
19656	EPBMWN3-A022H	90965
19657	EPBMWN4-A019H	92343
19658	EPBMFN4-D011H	94586
19659	EPBMFN4-V026H	94497
19659	EPBMFN4-V010H	97588
19660	EPBMFN5-D001H	95207
19661	EPBMFN4-D004H	91534
19662	EPBMFN4-V007H	93735
19663	EPBMFT5-V027H	94616
19664	EPBMFN4-D009H	96113
19665	EPBMFN5-A038H	93095
19666	EPBMFN4-V017H	96226
19667	EPBMFN4-V017H	96226
19668	EPBMFN4-V010H	97588
19669	EPBMWN3-A017H	95114
19670	EPBMWN3-A023H	91067
19671	EPBMWN5-V005H	93291
19674	EPBMFT5-V001P	93006
19681	EPBMWT5-D012H	91007
19694	EPBMFN4-V042H	94672
19712	EPBMFN4-V007H	93735

INTERMOTOR	→ NTK	Stock
19714	EPBMFT5-V001P	93006
19718	EPBMFT5-D038H	96961
19721	EPBMFT5-V001P	93006
19721	EPBMFT5-V042H	94057
19721	EPBMFN5-V032H	95044
19722	EPBMFT5-V001P	93006
19722	EPBMFT5-V042H	94057
19722	EPBMFN5-V032H	95044
19724	EPBMFT5-V017H	90311
19724	EPBMFT5-V001P	93006
19727	EPBMFT5-V020H	90244
19728	EPBMFT5-D040H	97032
19729	EPBMFT5-T011H	92630
19730	EPBMFT5-V020H	90244
19734	EPBMFT5-D047H	97067
19735	EPBMFT5-D056H	90827
19740	EPBMFN5-D033H	93804
19741	EPBMFT4-V004H	90957
19742	EPBMFT6-V046H	95763
19743	EPBMWN3-V009H	96875
19744	EPBMWN5-V008H	92710
19745	EPBMFN5-V005D	90496
19745	EPBMWN5-V005H	93291
19746	EPBMWT5-A014D	90205
19746	EPBMWT5-A005D	93145
19747	EPBMWN6-V004H	96070
19749	EPBMFT4-V048H	95493
19751	EPBMWT5-V010H	93933
19752	EPBMWT6-A007H	93605
19755	EPBMWT4-A001D	95860
19756	EPBMWT5-A014D	90205
19759	EPBMWN6-D030H	96504
19761	EPBMWT5-A006D	91258
19762	EPBMWT5-A014D	90205
19762	EPBMWT5-A005D	93145
19763	EPBMWT5-A014D	90205
19763	EPBMWT5-A009D	97997
19764	EPBMWT5-A014D	90205
19764	EPBMWT5-A005D	93145
19765	EPBMFT5-V002H	97685
19766	EPBMFT6-A049H	93243
19767	EPBMWT4-A011H	90069
19768	EPBMFT5-V001P	93006
19768	EPBMFT5-V007H	97257
19769	EPBMFT4-D050H	94911
19770	EPBMFT5-V005H	93645
19774	EPBMFN4-V020H	90971
19775	EPBMWN5-D003D	94436
19776	EPBMFN4-D014H	92888
19780	EPBMFN5-V001D	95368
19781	EPBMFN4-V031H	96741
19787	EPBMWT4-D018H	96715





Industry

INTERMOTOR	→ NTK	Stock
19789	EPBMWT4-A019H	94808
19790	EPBMWT4-A022H	93854
19791	EPBMWT4-A026H	95537
19792	EPBMWT4-A028H	91236
19826	EPBMFN5-D004P	93343
19854	EPBMWT5-A025H	93777
19855	EPBMWT5-A027H	96756
19859	EPBMWT5-V013D	92480
19859	EPBMWT5-A025H	93777
19869	EPBMWT5-A014D	90205
19377-M	EPBMFT5-T001D	94095
19401-M	EPBMFT5-V017H	90311
19401-M	EPBMFT5-V001P	93006
19402-M	EPBMWN3-A001H	97106
19412-M	EPBMFT5-V001P	93006
19412-M	EPBMFT5-V031H	97525
19435-M	EPBMWT5-A005H	93383
19442-M	EPBMFN5-D002P	91609
19442-M	EPBMFN5-D027H	94938
19454-M	EPBMFN4-D004H	91534
19456-M	EPBMFT5-D005P	90557
19456-M	EPBMFT5-D054H	94591
19464-M	EPBMWN3-A001H	97106
19631-M	EPBMWT6-A006H	94034
19650-M	EPBMWT6-A001H	90144
19651-M	EPBMWT5-A003H	93842
19652-M	EPBMWT5-A004H	91200
19655-M	EPBMWT4-V002H	92668
19659-M	EPBMFN4-V026H	94497
19659-M	EPBMFN4-V010H	97588
19666-M	EPBMFN4-V017H	96226
19700-M	EPBMFT5-D043H	90272
19700-M	EPBMFT5-D025H	90977
19700-M	EPBMFT5-D012H	93496
19700-M	EPBMFT5-D009H	95803
19700-M	EPBMFT5-D003P	96835
19700-M	EPBMFT5-D041H	97661
19701-M	EPBMFN5-D004P	93343
19702-M	EPBMFN5-D015H	90376
19702-M	EPBMFN5-D047H	91140
19702-M	EPBMFN5-D022H	91168
19702-M	EPBMFN5-D018H	91462
19702-M	EPBMFN5-D002P	91609
19702-M	EPBMFN5-D002H	91692
19702-M	EPBMFN5-D005H	92204
19702-M	EPBMFN5-D025H	94062
19702-M	EPBMFN5-D027H	94938
19702-M	EPBMFN5-D003H	95299
19702-M	EPBMFN5-D019H	95991
19702-M	EPBMFN5-D012H	96277
19702-M	EPBMFN5-D013H	96315
19702-M	EPBMFN5-D016H	96999

INTERMOTOR	→ NTK	Stock
19702-M	EPBMFN5-D023H	97946
19703-M	EPBMFT5-D005P	90557
19703-M	EPBMFT5-D032H	91598
19703-M	EPBMFT5-D028H	93297
19703-M	EPBMFT5-D024H	93373
19703-M	EPBMFT5-D054H	94591
19703-M	EPBMFT5-D045H	95253
19705-M	EPBMFT5-D043H	90272
19705-M	EPBMFT5-D036H	90481
19705-M	EPBMFT5-D025H	90977
19705-M	EPBMFT5-D016H	95579
19705-M	EPBMFT5-D009H	95803
19705-M	EPBMFT5-D018H	96224
19705-M	EPBMFT5-D003P	96835
19705-M	EPBMFT5-D041H	97661
19706-M	EPBMFT5-D015H	92304
19706-M	EPBMFT5-V001P	93006
19706-M	EPBMFT5-V042H	94057
19706-M	EPBMFN5-V032H	95044
19706-M	EPBMFT5-V021H	95278
19708-M	EPBMFT5-V017H	90311
19708-M	EPBMFT5-V039H	90466
19708-M	EPBMFT5-V029H	90502
19708-M	EPBMFT5-V055H	91808
19708-M	EPBMFT5-D015H	92304
19708-M	EPBMFT5-V001P	93006
19708-M	EPBMFN5-V043H	93581
19708-M	EPBMFT5-V008H	93715
19708-M	EPBMFT5-V042H	94057
19708-M	EPBMFT5-V035H	94119
19708-M	EPBMFN5-V032H	95044
19708-M	EPBMFT5-V021H	95278
19708-M	EPBMFT5-V037H	95360
19708-M	EPBMFT5-V019H	96039
19708-M	EPBMFT5-V010H	96310
19708-M	EPBMFT5-V030H	96975
19708-M	EPBMFT5-V007H	97257
19708-M	EPBMFT5-V031H	97525
19709-M	EPBMFT5-V017H	90311
19709-M	EPBMFT5-V001P	93006
19709-M	EPBMFT5-V007H	97257
19710-M	EPBMFT5-D036H	90481
19710-M	EPBMFT5-D016H	95579
19710-M	EPBMFT5-D009H	95803
19710-M	EPBMFT5-D003P	96835
19711-M	EPBMFN5-D002P	91609
19711-M	EPBMFN5-D002H	91692
19774-M	EPBMFN4-V020H	90971
19776-M	EPBMFN4-D014H	92888
19786-M	EPBMWT3-D024H	91171
19800-M	EPBMFN5-D002P	91609
19800-M	EPBMFN5-D005H	92204





INTERMOTOR	→ NTK	Stock
19801-M	EPBMFN5-D015H	90376
19801-M	EPBMFN5-D002P	91609
19802-M	EPBMFN5-D002P	91609
19802-M	EPBMFN5-D012H	96277
19803-M	EPBMFT5-D005P	90557
19804-M	EPBMFT5-D005P	90557
19805-M	EPBMFN5-D002P	91609
19805-M	EPBMFN5-D016H	96999
19806-M	EPBMFN5-D002P	91609
19806-M	EPBMFN5-D019H	95991
19807-M	EPBMFN5-D002P	91609
19807-M	EPBMFN5-D023H	97946
19808-M	EPBMFT5-D005P	90557
19808-M	EPBMFT5-D032H	91598
19808-M	EPBMFT5-D045H	95253
19809-M	EPBMFT5-D005P	90557
19809-M	EPBMFN5-D002P	91609
19809-M	EPBMFT5-D024H	93373
19809-M	EPBMFN5-D013H	96315
19810-M	EPBMFT5-D036H	90481
19810-M	EPBMFT5-D016H	95579
19810-M	EPBMFT5-D003P	96835
19811-M	EPBMFT5-D012H	93496
19812-M	EPBMFT5-D025H	90977
19812-M	EPBMFT5-D003P	96835
19813-M	EPBMFT5-D003P	96835
19813-M	EPBMFT5-D041H	97661
19814-M	EPBMFT5-D043H	90272
19814-M	EPBMFT5-D003P	96835
19815-M	EPBMFT5-V001P	93006
19815-M	EPBMFT5-V007H	97257
19816-M	EPBMFT5-V017H	90311
19816-M	EPBMFT5-V001P	93006
19817-M	EPBMFT5-V001P	93006
19817-M	EPBMFT5-V007H	97257
19818-M	EPBMFT5-V039H	90466
19818-M	EPBMFT5-V001P	93006
19818-M	EPBMFT5-V007H	97257
19819-M	EPBMFT5-V001P	93006
19819-M	EPBMFT5-V042H	94057
19819-M	EPBMFN5-V032H	95044
19819-M	EPBMFT5-V021H	95278
19820-M	EPBMFT5-V017H	90311
19820-M	EPBMFT5-V001P	93006
19821-M	EPBMFT5-V001P	93006
19821-M	EPBMFT5-V042H	94057
19822-M	EPBMFT5-V001P	93006
19822-M	EPBMFT5-V008H	93715
19822-M	EPBMFT5-V019H	96039
19823-M	EPBMFT5-V029H	90502
19823-M	EPBMFT5-V001P	93006
19823-M	EPBMFT5-V013H	96559

INTERMOTOR	→ NTK	Stock
19824-M	EPBMFT5-V055H	91808
19824-M	EPBMFT5-V001P	93006
19824-M	EPBMFT5-V030H	96975
19825-M	EPBMFN5-D002P	91609
19825-M	EPBMFN5-D002H	91692
19827-M	EPBMFN5-D022H	91168
19827-M	EPBMFN5-D002P	91609
19828-M	EPBMFT5-D005P	90557
19828-M	EPBMFT5-D032H	91598
19828-M	EPBMFT5-D045H	95253
19829-M	EPBMFN5-D002P	91609
19829-M	EPBMFN5-D003H	95299
19830-M	EPBMFN5-D002P	91609
19830-M	EPBMFN5-D016H	96999
19831-M	EPBMFN5-D002P	91609
19831-M	EPBMFN5-D025H	94062
19832-M	EPBMFT5-V001P	93006
19832-M	EPBMFT5-V010H	96310
19833-M	EPBMFT5-V001P	93006
19833-M	EPBMFT5-V037H	95360
19834-M	EPBMFT5-V039H	90466
19834-M	EPBMFT5-V001P	93006
19835-M	EPBMFT5-V001P	93006
19835-M	EPBMFT5-V007H	97257
19836-M	EPBMFN5-D018H	91462
19836-M	EPBMFN5-D002P	91609
19837-M	EPBMFT5-D005P	90557
19837-M	EPBMFT5-D028H	93297
19838-M	EPBMFT5-D009H	95803
19838-M	EPBMFT5-D003P	96835
19839-M	EPBMFT5-D018H	96224
19839-M	EPBMFT5-D003P	96835
19840-M	EPBMFT5-D015H	92304
19840-M	EPBMFT5-V001P	93006
19841-M	EPBMFT5-D023H	93770
19841-M	EPBMFT5-D003P	96835
19842-M	EPBMFN5-D047H	91140
19842-M	EPBMFN5-D002P	91609
JAPANPARTS	→ NTK	Stock
DE-101	EPBMWT6-A007H	93605
DE-200	EPBMWT5-A004D	91831
DE-201	EPBMWT5-A014D	90205
DE-201	EPBMWT5-A005D	93145
DE-800	EPBMFT5-V029H	90502
DE-800	EPBMFT5-V001P	93006
DE-H00	EPBMFT5-V013H	96559
DE-H01	EPBMFT5-V005H	93645
MEAT&DORIA	→ NTK	Stock
86004	EPBMFT5-V001P	93006
86004	EPBMFT5-V007H	97257
86006	EPBMFT5-V017H	90311
86006	EPBMFT5-V001P	93006





Industry

MEAT&DORIA	→ NTK	Stock
86007	EPBMFT5-V001P	93006
86009	EPBMFT5-V017H	90311
86009	EPBMFT5-V001P	93006
86010	EPBMFN5-D015H	90376
86010	EPBMFN5-D002P	91609
86011	EPBMFN5-D005H	92204
86013	EPBMWN6-D029H	90628
86014	EPBMFN6-R030H	90274
86016	EPBMWT4-V002H	92668
86017	EPBMFT5-V001P	93006
86017	EPBMFT5-V007H	97257
86019	EPBMWN4-A019H	92343
86020	EPBMFT5-D005P	90557
86020	EPBMFT5-D032H	91598
86020	EPBMFT5-D045H	95253
86021	EPBMFT5-D023H	93770
86021	EPBMFT5-D003P	96835
86022	EPBMFT5-V017H	90311
86022	EPBMFT5-V001P	93006
86024	EPBMFN5-D002P	91609
86024	EPBMFN5-D013H	96315
86025	EPBMWN5-A028H	96181
86026	EPBMWT5-A003H	93842
86028	EPBMWT6-A001H	90144
86029	EPBMWN4-A033H	97034
86030	EPBMWN4-A012H	96882
86032	EPBMFT5-D005P	90557
86033	EPBMWN3-A001H	97106
86034	EPBMWN4-R010H	96431
86036	EPBMWN3-A020H	92225
86037	EPBMWT5-D020H	97934
86038	EPBMFT5-V001P	93006
86038	EPBMFT5-V007H	97257
86040	EPBMFT5-V001P	93006
86040	EPBMFT5-V042H	94057
86042	EPBMFN5-D002P	91609
86042	EPBMFN5-D016H	96999
86043	EPBMWN3-A016H	93176
86044	EPBMWN4-D018H	96313
86046	EPBMFT5-V001P	93006
86046	EPBMFT5-V007H	97257
86047	EPBMFT5-D005P	90557
86047	EPBMFT5-D024H	93373
86047	EPBMFN5-D013H	96315
86048	EPBMFT5-V001P	93006
86048	EPBMFT5-V031H	97525
86049	EPBMWN3-A022H	90965
86050	EPBMWT4-D014H	93236
86051	EPBMFT6-A026H	93281
86053	EPBMWN4-A025H	91852
86054	EPBMWN4-A026H	97860
86056	EPBMWN4-A011H	96418

MEAT&DORIA	→ NTK	Stock
86057	EPBMFT5-D005P	90557
86058	EPBMWN5-D014H	96884
86060	EPBMFN4-A045H	92062
86061	EPBMFN5-D004P	93343
86062	EPBMFT5-V001P	93006
86062	EPBMFT5-V008H	93715
86063	EPBMFT5-D005P	90557
86063	EPBMFT5-D032H	91598
86066	EPBMFN4-A039H	95306
86068	EPBMFN4-D040H	96545
86070	EPBMFT5-D009H	95803
86070	EPBMFT5-D003P	96835
86071	EPBMFT5-D025H	90977
86071	EPBMFT5-D003P	96835
86072	EPBMFN5-D002P	91609
86072	EPBMFN5-D016H	96999
86073	EPBMFN4-A037H	94866
86075	EPBMFN5-D022H	91168
86075	EPBMFN5-D002P	91609
86076	EPBMFT5-V001P	93006
86076	EPBMFN5-V043H	93581
86077	EPBMFN5-A029H	90647
86078	EPBMFT6-A044H	92490
86079	EPBMFN4-V026H	94497
86079	EPBMFN4-V010H	97588
86086	EPBMWT5-A004H	91200
86087	EPBMWT5-A005H	93383
86088	EPBMFT5-V029H	90502
86088	EPBMFT5-V001P	93006
86098	EPBMFN5-D002P	91609
86098	EPBMFN5-D003H	95299
86099	EPBMFN5-D002P	91609
86099	EPBMFN5-D002H	91692
86102	EPBMFT5-A052H	95671
86103	EPBMFT5-D015H	92304
86103	EPBMFT5-V001P	93006
86104	EPBMFT5-V010H	96310
86105	EPBMFT5-V029H	90502
86106	EPBMFT5-V017H	90311
86107	EPBMFT5-V055H	91808
86107	EPBMFT5-V001P	93006
86107	EPBMFT5-V030H	96975
86109	EPBMFT5-V039H	90466
86109	EPBMFT5-V001P	93006
86110	EPBMWT5-V015H	92930
86112	EPBMFN5-D018H	91462
86112	EPBMFN5-D002P	91609
86113	EPBMFT5-V039H	90466
86114	EPBMFN5-D002P	91609
86114	EPBMFN5-D012H	96277
86115	EPBMFT5-V017H	90311
86116	EPBMWT4-A009H	92423



MEAT&DORIA	→ NTK	Stock
86117	EPBMFT5-V001P	93006
86118	EPBMWT5-D017H	94348
86119	EPBMWN3-A015H	97380
86120	EPBMWN5-D003H	92791
86121	EPBMWT6-A006H	94034
86123	EPBMWT5-V021H	97091
86124	EPBMWN3-A023H	91067
86125	EPBMWT5-D012H	91007
86126	EPBMFT5-V013H	96559
86128	EPBMFN4-A035H	97899
86129	EPBMWN3-A021H	93365
86130	EPBMFT5-V017H	90311
86130	EPBMFT5-V001P	93006
86131	EPBMFT5-D043H	90272
86131	EPBMFT5-D003P	96835
86133	EPBMFN5-D002P	91609
86133	EPBMFN5-D019H	95991
86135	EPBMFT5-D018H	96224
86135	EPBMFT5-D003P	96835
86136	EPBMFT5-D003P	96835
86136	EPBMFT5-D041H	97661
86137	EPBMFN5-D002P	91609
86137	EPBMFN5-D027H	94938
86142	EPBMWT5-A014D	90205
86142	EPBMWT5-A005D	93145
86144	EPBMFN4-D011H	94586
86146	EPBMFT5-A001H	93740
86146	EPBMWT4-V002D	95695
86147	EPBMWT4-A008H	90627
86148	EPBMWN3-V031H	90825
86149	EPBMWT4-A011H	90069
86149	EPBMWT4-A008H	90627
86151	EPBMWT5-V023H	95103
86153	EPBMFN4-V020H	90971
86156	EPBMFT5-V029H	90502
86156	EPBMFT5-V001P	93006
86157	EPBMFT5-V001P	93006
86157	EPBMFT5-V007H	97257
86158	EPBMFT5-V022H	93863
86159	EPBMFT5-D036H	90481
86159	EPBMFT5-D016H	95579
86159	EPBMFT5-D003P	96835
86160	EPBMFT5-V010H	96310
86161	EPBMFT5-V001P	93006
86161	EPBMFT5-V010H	96310
86163	EPBMFN3-A028H	94128
86167	EPBMWN5-V005H	93291
86169	EPBMFT4-D050H	94911
86172	EPBMWN4-V002H	92462
86174	EPBMWN5-V008H	92710
86175	EPBMWN3-A017H	95114
86179	EPBMFN4-V017H	96226

MEAT&DORIA	→ NTK	Stock
86180	EPBMFT4-V004H	90957
86181	EPBMWN6-V004H	96070
86182	EPBMFN4-D014H	92888
86184	EPBMWN6-D030H	96504
86185	EPBMFT5-V055H	91808
86185	EPBMFT5-V030H	96975
86186	EPBMFN4-D004H	91534
86187	EPBMFT6-V046H	95763
86188	EPBMFN4-V026H	94497
86188	EPBMFN4-V010H	97588
86189	EPBMWT6-A007H	93605
86193	EPBMFT4-V048H	95493
86194	EPBMFT5-V020H	90244
86197	EPBMFT4-V004H	90957
86199	EPBMWT5-A014D	90205
86199	EPBMWT5-A005D	93145
86203	EPBMFT4-V061H	94528
86205	EPBMFT6-A049H	93243
86209	EPBMFN4-D009H	96113
86210	EPBMFN4-V007H	93735
86211	EPBMFT5-V005H	93645
86213	EPBMFT5-V027H	94616
86215	EPBMFT5-V006H	94366
86217	EPBMFN5-D001H	95207
86218	EPBMWN5-D006H	92698
86218	EPBMWN5-D003D	94436
86219	EPBMFN5-D021H	90140
86220	EPBMFN5-D033H	93804
86223	EPBMFN4-D004H	91534
86225	EPBMFT5-D059H	94271
86226	EPBMFN5-D002P	91609
86226	EPBMFN5-D025H	94062
86228	EPBMFT5-V001P	93006
86228	EPBMFT5-V035H	94119
86231	EPBMFN4-D009H	96113
86232	EPBMFT5-V017H	90311
86234	EPBMFT5-V001P	93006
86234	EPBMFT5-V021H	95278
86235	EPBMFT5-V017H	90311
86235	EPBMFT5-V001P	93006
86236	EPBMFT5-D005P	90557
86236	EPBMFT5-D054H	94591
86238	EPBMFT5-D034H	96295
86239	EPBMFT5-V002H	97685
86240	EPBMFT5-V001P	93006
86240	EPBMFN5-V032H	95044
86241	EPBMFT5-V017H	90311
86241	EPBMFT5-V001P	93006
86242	EPBMFT5-D009H	95803
86242	EPBMFT5-D003P	96835
86243	EPBMFT5-D005P	90557
86243	EPBMFT5-D028H	93297





Industry

MEAT&DORIA	→ NTK	Stock
86244	EPBMFT5-D038H	96961
86245	EPBMFN5-D002P	91609
86245	EPBMFN5-D023H	97946
86246	EPBMFT5-V033H	95261
86248	EPBMFT5-V001P	93006
86252	EPBMFT5-D009H	95803
86252	EPBMFT5-D003P	96835
86253	EPBMFT5-D003P	96835
86254	EPBMFT5-D012H	93496
86255	EPBMFT5-V008H	93715
86256	EPBMFT5-V008H	93715
86257	EPBMFT5-V001P	93006
86257	EPBMFT5-V037H	95360
86259	EPBMFN4-A041H	97353
86261	EPBMFN4-A035H	97899
86262	EPBMFN4-A044H	96776
86264	EPBMFT5-V001P	93006
86264	EPBMFN5-V032H	95044
86264	EPBMFT5-V021H	95278
86265	EPBMFN4-A046H	90609
86269	EPBMWN3-A007H	93658
86271	EPBMFT5-V005H	93645
86272	EPBMWT5-D012H	91007
86274	EPBMFT5-T011H	92630
86275	EPBMFT5-T003H	91493
86276	EPBMWN5-D027H	91976
86277	EPBMWN3-V009H	96875
86279	EPBMWT6-V013H	92412
86283	EPBMWT4-A026H	95537
86285	EPBMFN4-D009H	96113
86286	EPBMFN5-V005D	90496
86291	EPBMFN5-V005D	90496
86292	EPBMFN4-V031H	96741
86293	EPBMFT5-V001P	93006
86294	EPBMFT5-V020H	90244
86295	EPBMFT5-T011H	92630
86296	EPBMFT5-T062H	91666
86296	EPBMFT5-T001D	94095
86297	EPBMWN4-A024H	90997
86300	EPBMFN4-D014H	92888
86303	EPBMFN4-V008H	95035
86305	EPBMWT4-A028H	91236
86307	EPBMWT5-A025H	93777
86316	EPBMWT4-D018H	96715
86318	EPBMFN5-A038H	93095
86336	EPBMFN5-V001D	95368
86337	EPBMFT5-V053H	95935
86339	EPBMFT5-D047H	97067
86340	EPBMFT5-V001P	93006
86340	EPBMFT5-V021H	95278
86342	EPBMFT5-D040H	97032
86350	EPBMFN5-D047H	91140

MEAT&DORIA	→ NTK	Stock
86350	EPBMFN5-D002P	91609
86355	EPBMWT4-A019H	94808
86357	EPBMWT6-A001H	90144
86359	EPBMWT3-D024H	91171
86360	EPBMWT4-A022H	93854
86361	EPBMWT5-A027H	96756
86362	EPBMFN4-D014H	92888
86367	EPBMFN4-V020H	90971
86374	EPBMWT5-V010H	93933
86376	EPBMFT5-A051H	90866
86378	EPBMFT5-V002H	97685
86397	EPBMFT5-D056H	90827
86410	EPBMFT4-V061H	94528
86430	EPBMFN5-V032H	95044
86432	EPBMFT5-V053H	95935
86455	EPBMFT5-V035H	94119
86463	EPBMFN4-V042H	94672
86474	EPBMFT4-V061H	94528
86004E	EPBMFT5-V001P	93006
86004E	EPBMFT5-V007H	97257
86006E	EPBMFT5-V017H	90311
86006E	EPBMFT5-V001P	93006
86007E	EPBMFT5-V001P	93006
86009E	EPBMFT5-V017H	90311
86009E	EPBMFT5-V001P	93006
86010E	EPBMFN5-D015H	90376
86010E	EPBMFN5-D002P	91609
86011E	EPBMFN5-D005H	92204
86013E	EPBMWN6-D029H	90628
86014E	EPBMFN6-R030H	90274
86016E	EPBMWT4-V002H	92668
86017E	EPBMFT5-V001P	93006
86017E	EPBMFT5-V007H	97257
86019E	EPBMWN4-A019H	92343
86020E	EPBMFT5-D005P	90557
86020E	EPBMFT5-D032H	91598
86020E	EPBMFT5-D045H	95253
86021E	EPBMFT5-D023H	93770
86021E	EPBMFT5-D003P	96835
86022E	EPBMFT5-V017H	90311
86022E	EPBMFT5-V001P	93006
86024E	EPBMFN5-D002P	91609
86024E	EPBMFN5-D013H	96315
86025E	EPBMWN5-A028H	96181
86026E	EPBMWT5-A003H	93842
86028E	EPBMWT6-A001H	90144
86029E	EPBMWN4-A033H	97034
86030E	EPBMWN4-A012H	96882
86032E	EPBMFT5-D005P	90557
86033E	EPBMWN3-A001H	97106
86036E	EPBMWN3-A020H	92225
86037E	EPBMWT5-D020H	97934



MEAT&DORIA	→ NTK	Stock
86038E	EPBMFT5-V001P	93006
86038E	EPBMFT5-V007H	97257
86040E	EPBMFT5-V001P	93006
86040E	EPBMFT5-V042H	94057
86042E	EPBMFN5-D002P	91609
86042E	EPBMFN5-D016H	96999
86043E	EPBMWN3-A016H	93176
86044E	EPBMWN4-D018H	96313
86046E	EPBMFT5-V001P	93006
86046E	EPBMFT5-V007H	97257
86047E	EPBMFT5-D005P	90557
86047E	EPBMFT5-D024H	93373
86047E	EPBMFN5-D013H	96315
86048E	EPBMFT5-V001P	93006
86048E	EPBMFT5-V031H	97525
86049E	EPBMWN3-A022H	90965
86050E	EPBMWT4-D014H	93236
86051E	EPBMFT6-A026H	93281
86053/1	EPBMWN4-A025H	91852
86054A1	EPBMWN4-A026H	97860
86054E	EPBMWN4-A026H	97860
86056E	EPBMWN4-A011H	96418
86057E	EPBMFT5-D005P	90557
86060/1	EPBMFN4-A045H	92062
86061E	EPBMFN5-D004P	93343
86063E	EPBMFT5-D005P	90557
86063E	EPBMFT5-D032H	91598
86066E	EPBMFN4-A039H	95306
86068E	EPBMFN4-D040H	96545
86070E	EPBMFT5-D009H	95803
86070E	EPBMFT5-D003P	96835
86071E	EPBMFT5-D025H	90977
86071E	EPBMFT5-D003P	96835
86072E	EPBMFN5-D002P	91609
86072E	EPBMFN5-D016H	96999
86073E	EPBMFN4-A037H	94866
86075E	EPBMFN5-D022H	91168
86075E	EPBMFN5-D002P	91609
86076E	EPBMFT5-V001P	93006
86076E	EPBMFN5-V043H	93581
86077E	EPBMFN5-A029H	90647
86078E	EPBMFT6-A044H	92490
86079E	EPBMFN4-V026H	94497
86079E	EPBMFN4-V010H	97588
86086E	EPBMWT5-A004H	91200
86087E	EPBMWT5-A005H	93383
86088E	EPBMFT5-V029H	90502
86088E	EPBMFT5-V001P	93006
86098E	EPBMFN5-D002P	91609
86098E	EPBMFN5-D003H	95299
86099E	EPBMFN5-D002P	91609
86099E	EPBMFN5-D002H	91692

MEAT&DORIA	→ NTK	Stock
86102E	EPBMFT5-A052H	95671
86103E	EPBMFT5-D015H	92304
86103E	EPBMFT5-V001P	93006
86104E	EPBMFT5-V010H	96310
86105E	EPBMFT5-V029H	90502
86106E	EPBMFT5-V017H	90311
86107/1	EPBMFT5-V055H	91808
86107/1	EPBMFT5-V001P	93006
86107/1	EPBMFT5-V030H	96975
86109E	EPBMFT5-V039H	90466
86109E	EPBMFT5-V001P	93006
86112E	EPBMFN5-D018H	91462
86112E	EPBMFN5-D002P	91609
86113E	EPBMFT5-V039H	90466
86114E	EPBMFN5-D002P	91609
86114E	EPBMFN5-D012H	96277
86115E	EPBMFT5-V017H	90311
86116E	EPBMWT4-A009H	92423
86117E	EPBMFT5-V001P	93006
86118E	EPBMWT5-D017H	94348
86120E	EPBMWN5-D003H	92791
86121E	EPBMWT6-A006H	94034
86124E	EPBMWN3-A023H	91067
86125E	EPBMWT5-D012H	91007
86126E	EPBMFT5-V013H	96559
86128E	EPBMFN4-A035H	97899
86129E	EPBMWN3-A021H	93365
86130E	EPBMFT5-V017H	90311
86130E	EPBMFT5-V001P	93006
86131E	EPBMFT5-D043H	90272
86131E	EPBMFT5-D003P	96835
86133E	EPBMFN5-D002P	91609
86133E	EPBMFN5-D019H	95991
86135E	EPBMFT5-D018H	96224
86135E	EPBMFT5-D003P	96835
86136E	EPBMFT5-D003P	96835
86136E	EPBMFT5-D041H	97661
86144/1	EPBMFN4-D011H	94586
86146E	EPBMFT5-A001H	93740
86146E	EPBMWT4-V002D	95695
86147E	EPBMWT4-A008H	90627
86148E	EPBMWN3-V031H	90825
86149E	EPBMWT4-A011H	90069
86149E	EPBMWT4-A008H	90627
86153E	EPBMFN4-V020H	90971
86156E	EPBMFT5-V029H	90502
86156E	EPBMFT5-V001P	93006
86157E	EPBMFT5-V001P	93006
86157E	EPBMFT5-V007H	97257
86158E	EPBMFT5-V022H	93863
86159E	EPBMFT5-D036H	90481
86159E	EPBMFT5-D016H	95579





Industry

MEAT&DORIA	→ NTK	Stock
86159E	EPBMFT5-D003P	96835
86160E	EPBMFT5-V010H	96310
86161E	EPBMFT5-V001P	93006
86161E	EPBMFT5-V010H	96310
86163E	EPBMFN3-A028H	94128
86167E	EPBMWN5-V005H	93291
86169E	EPBMFT4-D050H	94911
86172E	EPBMWN4-V002H	92462
86174E	EPBMWN5-V008H	92710
86175E	EPBMWN3-A017H	95114
86179E	EPBMFT4-V004H	90957
86179E	EPBMFN4-V017H	96226
86180E	EPBMFT4-V004H	90957
86181E	EPBMWN6-V004H	96070
86182A1	EPBMFN4-D014H	92888
86182E	EPBMFN4-D014H	92888
86184E	EPBMWN6-D030H	96504
86185E	EPBMFT5-V055H	91808
86185E	EPBMFT5-V030H	96975
86186E	EPBMFN4-D004H	91534
86187E	EPBMFT6-V046H	95763
86189E	EPBMWT6-A007H	93605
86193E	EPBMFT4-V048H	95493
86199E	EPBMWT5-A014D	90205
86199E	EPBMWT5-A005D	93145
86205E	EPBMFT6-A049H	93243
86210E	EPBMFN4-V007H	93735
86211E	EPBMFT5-V005H	93645
86213E	EPBMFT5-V027H	94616
86215E	EPBMFT5-V006H	94366
86217E	EPBMFN5-D001H	95207
86218E	EPBMWN5-D006H	92698
86218E	EPBMWN5-D003D	94436
86220E	EPBMFN5-D033H	93804
86223E	EPBMFN4-D004H	91534
86226E	EPBMFN5-D002P	91609
86226E	EPBMFN5-D025H	94062
86228E	EPBMFT5-V001P	93006
86228E	EPBMFT5-V035H	94119
86232E	EPBMFT5-V017H	90311
86234E	EPBMFT5-V001P	93006
86234E	EPBMFT5-V021H	95278
86235E	EPBMFT5-V017H	90311
86235E	EPBMFT5-V001P	93006
86236E	EPBMFT5-D005P	90557
86236E	EPBMFT5-D054H	94591
86238E	EPBMFT5-D034H	96295
86239E	EPBMFT5-V002H	97685
86241E	EPBMFT5-V017H	90311
86241E	EPBMFT5-V001P	93006
86242E	EPBMFT5-D009H	95803
86242E	EPBMFT5-D003P	96835

MEAT&DORIA	→ NTK	Stock
86244E	EPBMFT5-D038H	96961
86245E	EPBMFN5-D002P	91609
86245E	EPBMFN5-D023H	97946
86253E	EPBMFT5-D003P	96835
86254E	EPBMFT5-D012H	93496
86255E	EPBMFT5-V008H	93715
86256E	EPBMFT5-V008H	93715
86259E	EPBMFN4-A041H	97353
86261E	EPBMFN4-A035H	97899
86262E	EPBMFN4-A044H	96776
86264E	EPBMFT5-V001P	93006
86264E	EPBMFN5-V032H	95044
86264E	EPBMFT5-V021H	95278
86265E	EPBMFN4-A046H	90609
86274E	EPBMFT5-T011H	92630
86275E	EPBMFT5-T003H	91493
86276E	EPBMWN5-D027H	91976
86279E	EPBMWT6-V013H	92412
86283E	EPBMWT4-A026H	95537
86285A1	EPBMFN4-D009H	96113
86285E	EPBMFN4-D009H	96113
86291E	EPBMFN5-V005D	90496
86296E	EPBMFT5-T062H	91666
86296E	EPBMFT5-T001D	94095
86303A1	EPBMFN4-V008H	95035
86303E	EPBMFN4-V008H	95035
86316E	EPBMWT4-D018H	96715
86317E	EPBMWT4-A011H	90069
86318E	EPBMFN5-A038H	93095
86340E	EPBMFT5-V001P	93006
86340E	EPBMFT5-V021H	95278
86359A1	EPBMWT3-D024H	91171
86359E	EPBMWT3-D024H	91171
86362E	EPBMFN4-D014H	92888
86367E	EPBMFN4-V020H	90971
MOBILETRON	→ NTK	Stock
MA-B001	EPBMFT5-V001P	93006
MA-B001	EPBMFT5-V007H	97257
MA-B002	EPBMFT5-D025H	90977
MA-B002	EPBMFT5-D003P	96835
MA-B003	EPBMFN5-D002P	91609
MA-B003	EPBMFN5-D012H	96277
MA-B004	EPBMFT5-V017H	90311
MA-B004	EPBMFT5-V001P	93006
MA-B005	EPBMFT5-V039H	90466
MA-B006	EPBMFT5-V039H	90466
MA-B007	EPBMFT5-D009H	95803
MA-B007	EPBMFT5-D003P	96835
MA-B008	EPBMFN5-D002P	91609
MA-B008	EPBMFN5-D005H	92204
MA-B009	EPBMFN5-D015H	90376
MA-B009	EPBMFN5-D002P	91609





MOBILETRON	→ NTK	Stock
MA-B010	EPBMFN4-A041H	97353
MA-B012S	EPBMFT5-V001P	93006
MA-B013	EPBMFT5-V017H	90311
MA-B013	EPBMFT5-V001P	93006
MA-B014	EPBMFT5-V001P	93006
MA-B015	EPBMWN5-D014H	96884
MA-B016	EPBMFN6-R030H	90274
MA-B021	EPBMFT5-D005P	90557
MA-B022	EPBMFN5-D002P	91609
MA-B022	EPBMFN5-D003H	95299
MA-B023S	EPBMFN5-D004P	93343
MA-B024	EPBMFN5-D002P	91609
MA-B024	EPBMFN5-D016H	96999
MA-B025	EPBMFN5-D002P	91609
MA-B025	EPBMFN5-D023H	97946
MA-B027	EPBMFN5-D018H	91462
MA-B027	EPBMFN5-D002P	91609
MA-B028	EPBMFN5-D002P	91609
MA-B028	EPBMFN5-D013H	96315
MA-B029	EPBMFT5-D005P	90557
MA-B029	EPBMFT5-D024H	93373
MA-B030	EPBMWN3-A022H	90965
MA-B031	EPBMFT5-D012H	93496
MA-B033	EPBMFT5-D060H	95878
MA-B037	EPBMFT5-D036H	90481
MA-B037	EPBMFT5-D016H	95579
MA-B037S	EPBMFT5-D036H	90481
MA-B037S	EPBMFT5-D016H	95579
MA-B038	EPBMFT5-D023H	93770
MA-B038	EPBMFT5-D003P	96835
MA-B039	EPBMWN3-A001H	97106
MA-B040	EPBMFT5-V001P	93006
MA-B040	EPBMFT5-V008H	93715
MA-B041	EPBMWT5-A003H	93842
MA-B042	EPBMWT5-A004H	91200
MA-B044	EPBMFT5-V001P	93006
MA-B044	EPBMFT5-V031H	97525
MA-B045	EPBMFN5-V032H	95044
MA-B048	EPBMFT5-V017H	90311
MA-B048	EPBMFT5-V001P	93006
MA-B050	EPBMFN4-D040H	96545
MA-B054	EPBMFT5-D003P	96835
MA-B054	EPBMFT5-D041H	97661
MA-B056	EPBMFT5-D043H	90272
MA-B056	EPBMFT5-D003P	96835
MA-B057	EPBMWT5-D017H	94348
MA-B058	EPBMWN3-A007H	93658
MA-B059	EPBMFN4-A039H	95306
MA-B063	EPBMFT5-V001P	93006
MA-B063	EPBMFN5-V043H	93581
MA-B064	EPBMWN4-D018H	96313
MA-B065	EPBMFN4-V036H	95777

MOBILETRON	→ NTK	Stock
MA-B066	EPBMFT5-V027H	94616
MA-B068	EPBMFT5-V035H	94119
MA-B069	EPBMFT5-V001P	93006
MA-B071	EPBMFT5-D005P	90557
MA-B073	EPBMFN4-A037H	94866
MA-B074	EPBMFT5-D005P	90557
MA-B074	EPBMFT5-D032H	91598
MA-B074	EPBMFT5-D045H	95253
MA-B075	EPBMFN5-D002P	91609
MA-B075	EPBMFN5-D019H	95991
MA-B077	EPBMFN5-V032H	95044
MA-B078	EPBMFN4-V026H	94497
MA-B078	EPBMFN4-V010H	97588
MA-B079	EPBMFT5-V001P	93006
MA-B079	EPBMFT5-V021H	95278
MA-B082	EPBMWT4-D014H	93236
MA-B083	EPBMFN5-D022H	91168
MA-B083	EPBMFN5-D002P	91609
MA-B084	EPBMFN4-A046H	90609
MA-B085	EPBMFT5-D005P	90557
MA-B085	EPBMFT5-D032H	91598
MA-B086	EPBMFT5-V001P	93006
MA-B086	EPBMFT5-V007H	97257
MA-B088	EPBMFT5-V029H	90502
MA-B088	EPBMFT5-V001P	93006
MA-B090	EPBMFN5-D002P	91609
MA-B090	EPBMFN5-D016H	96999
MA-B092	EPBMFT5-V039H	90466
MA-B092	EPBMFT5-V001P	93006
MA-B093	EPBMFT5-D056H	90827
MA-B094	EPBMFT5-D015H	92304
MA-B094	EPBMFT5-V001P	93006
MA-B098	EPBMFT5-D059H	94271
MA-B099	EPBMFN5-D021H	90140
MA-B100	EPBMWT5-A005H	93383
MA-B101	EPBMWN6-D029H	90628
MA-B102	EPBMFN5-D002P	91609
MA-B102	EPBMFN5-D025H	94062
MA-B103	EPBMWN3-A021H	93365
MA-B104S	EPBMFN5-D004P	93343
MA-B106	EPBMFT5-D009H	95803
MA-B106	EPBMFT5-D003P	96835
MA-B107	EPBMFT5-V001P	93006
MA-B107	EPBMFT5-V037H	95360
MA-B108	EPBMFN4-V020H	90971
MA-B109	EPBMWN5-D003H	92791
MA-B110	EPBMWN3-A016H	93176
MA-B120	EPBMFT5-V001P	93006
MA-B120	EPBMFN5-V032H	95044
MA-B120	EPBMFT5-V021H	95278
MA-B129	EPBMFN6-A034H	91004
MA-B130	EPBMFN4-D011H	94586





Industry

MOBILETRON	→ NTK	Stock
MA-B131	EPBMFT5-D005P	90557
MA-B131	EPBMFT5-D054H	94591
MA-B132	EPBMFT5-D038H	96961
MA-B133	EPBMFT5-D005P	90557
MA-B133	EPBMFT5-D028H	93297
MA-B146	EPBMFT5-D005P	90557
MA-B152S	EPBMFT5-D003P	96835
MA-B153S	EPBMFT5-V001P	93006
MA-B154	EPBMFT5-V001P	93006
MA-B155	EPBMFT5-V008H	93715
MA-B156	EPBMFN5-D002P	91609
MA-B156	EPBMFN5-D027H	94938
MA-B157	EPBMFT6-A044H	92490
MA-B158	EPBMWT6-A006H	94034
MA-B159	EPBMWN3-A015H	97380
MA-B160	EPBMWN3-A001H	97106
MA-B161	EPBMWN4-R010H	96431
MA-B162	EPBMWT4-A008H	90627
MA-B163	EPBMWT5-D020H	97934
MA-B164	EPBMWT4-A009H	92423
MA-B165	EPBMWT5-V021H	97091
MA-B166	EPBMWN4-A033H	97034
MA-B167	EPBMWN3-A020H	92225
MA-B174	EPBMWT4-A011H	90069
MA-B175	EPBMWN3-A023H	91067
MA-B176	EPBMFT5-V058H	93155
MA-B177	EPBMFN5-D004P	93343
MA-B177S	EPBMFN5-D004P	93343
MA-B179	EPBMFT5-V001P	93006
MA-B179	EPBMFT5-V035H	94119
MA-B180	EPBMFT5-V029H	90502
MA-B180	EPBMFT5-V001P	93006
MA-B181	EPBMFT5-V017H	90311
MA-B181	EPBMFT5-V001P	93006
MA-B182	EPBMFT5-D009H	95803
MA-B182	EPBMFT5-D003P	96835
MA-B183	EPBMFT5-D034H	96295
MA-B187	EPBMFT5-V022H	93863
MA-B188	EPBMWN6-D030H	96504
MA-B191	EPBMWT6-A007H	93605
MA-B193	EPBMFT5-V020H	90244
MA-B195	EPBMWN6-V004H	96070
MA-B196	EPBMFT5-V006H	94366
MA-B200	EPBMFN4-V026H	94497
MA-B200	EPBMFN4-V010H	97588
MA-B202	EPBMFT6-A049H	93243
MA-B203S	EPBMFN4-A039H	95306
MA-B205	EPBMWT5-V010H	93933
MA-B206	EPBMFT5-T003H	91493
MA-B207	EPBMFN5-D001H	95207
MA-B209	EPBMFT6-V046H	95763
MA-B210	EPBMFN4-V017H	96226

MOBILETRON	→ NTK	Stock
MA-B211	EPBMFT5-D014H	95484
MA-B212	EPBMFN4-D014H	92888
MA-B213	EPBMFT5-D005P	90557
MA-B214S	EPBMFT5-T001D	94095
MA-B216S	EPBMWN5-D003D	94436
MA-B217	EPBMWT5-A025H	93777
MA-B219	EPBMFT4-V048H	95493
MA-B221	EPBMFT5-D040H	97032
MA-B222S	EPBMWT5-A027H	96756
MA-B224	EPBMFT4-V004H	90957
MA-B225	EPBMFN4-D004H	91534
MA-B226	EPBMFT5-T011H	92630
MA-B228S	EPBMWN5-D027H	91976
MA-B229	EPBMFN5-D033H	93804
MA-B232	EPBMFN5-A038H	93095
MA-B234	EPBMFN4-D009H	96113
MA-B235	EPBMFT4-D050H	94911
MA-B236	EPBMWN3-V009H	96875
MA-B238	EPBMFN4-V008H	95035
MA-B246	EPBMFN4-D014H	92888
MA-B248	EPBMFN4-V007H	93735
MA-B249	EPBMFN4-V007H	93735
MA-F001	EPBMFN5-D002P	91609
MA-F001	EPBMFN5-D002H	91692
MA-F002	EPBMWN4-A011H	96418
MA-F004	EPBMFT5-A001H	93740
MA-F005	EPBMFT6-A026H	93281
MA-F006	EPBMWN4-A012H	96882
MA-F008S	EPBMWT4-A001D	95860
MA-F009	EPBMWN4-A025H	91852
MA-F012	EPBMWN5-A028H	96181
MA-F013	EPBMFT5-V033H	95261
MA-F026S	EPBMWT4-V002D	95695
MA-F037S	EPBMWN4-A002D	91111
MA-F043S	EPBMFT6-A026H	93281
MA-F057	EPBMWN4-V002H	92462
MA-F065	EPBMFT5-V001P	93006
MA-F065	EPBMFT5-V021H	95278
MA-F071S	EPBMWT4-V003D	94395
MA-G001	EPBMFT5-V001P	93006
MA-G001	EPBMFT5-V010H	96310
MA-G003	EPBMFT5-V017H	90311
MA-G003	EPBMFT5-V001P	93006
MA-G004	EPBMFN4-A044H	96776
MA-G005	EPBMFT5-V001P	93006
MA-G005	EPBMFT5-V007H	97257
MA-G006	EPBMFT5-V001P	93006
MA-G006	EPBMFT5-V007H	97257
MA-G007	EPBMWT4-V002H	92668
MA-G009	EPBMFN4-A045H	92062
MA-G010	EPBMFT5-V010H	96310
MA-G011	EPBMWT6-A001H	90144





MOBILETRON	→ NTK	Stock
MA-G012	EPBMFT5-V001P	93006
MA-G012	EPBMFT5-V019H	96039
MA-G013	EPBMFT5-V001P	93006
MA-G013	EPBMFT5-V007H	97257
MA-G014	EPBMFT5-V017H	90311
MA-G014	EPBMFT5-V001P	93006
MA-H001	EPBMFT5-V039H	90466
MA-H001	EPBMFT5-V001P	93006
MA-K001	EPBMFN3-A028H	94128
MA-K002	EPBMWN3-A017H	95114
MA-K003	EPBMWT5-D012H	91007
MA-K004	EPBMFN4-A035H	97899
MA-K006	EPBMFT5-V055H	91808
MA-K006	EPBMFT5-V030H	96975
MA-MZ001S	EPBMWT5-A014D	90205
MA-MZ001S	EPBMWT5-A005D	93145
MA-NS002	EPBMFN5-A029H	90647
MA-NS003	EPBMFT5-V001P	93006
MA-NS003	EPBMFT5-V042H	94057
MA-NS007	EPBMWN5-V005H	93291
MA-NS010	EPBMWN3-V031H	90825
MA-NS012S	EPBMFN5-V005D	90496
MA-NS017	EPBMFT5-A052H	95671
MA-S001	EPBMWN4-A019H	92343
MA-SU001	EPBMWN5-V008H	92710
MA-T002S	EPBMWT5-A014D	90205
MA-T003S	EPBMWT5-A014D	90205
MA-T003S	EPBMWT5-A009D	97997
MA-T004S	EPBMWT5-A006D	91258
MA-T012S	EPBMWT5-A014D	90205
MA-T012S	EPBMWT5-A011D	92781
MA-T015S	EPBMFT5-V002D	97692
MA-T016S	EPBMWT5-A004D	91831
MA-T017S	EPBMWT5-V012D	95034
MA-US001S	EPBMWT5-V023H	95103
MA-Y001	EPBMFT5-V010H	96310
MA-Y002	EPBMFT5-V017H	90311
MA-Y003	EPBMFT5-V013H	96559
MA-Y005	EPBMFT5-V017H	90311
MA-Y007	EPBMFT5-V055H	91808
MA-Y007	EPBMFT5-V001P	93006
MA-Y007	EPBMFT5-V030H	96975
MA-Y009	EPBMFT5-V017H	90311
MA-Y012	EPBMFT5-V005H	93645
PIERBURG	→ NTK	Stock
7.07759.00.0	EPBMFN4-D040H	96545
7.07759.02.0	EPBMFN4-A037H	94866
7.07759.03.0	EPBMFN4-A039H	95306
7.07759.07.0	EPBMFN4-A041H	97353
7.07759.08.0	EPBMWN5-V008H	92710
7.07759.09.0	EPBMWN3-A001H	97106
7.07759.10.0	EPBMWN3-A017H	95114

PIERBURG	→ NTK	Stock
7.07759.11.0	EPBMWT5-D012H	91007
7.07759.12.0	EPBMWN3-A023H	91067
7.07759.14.0	EPBMFN6-A034H	91004
7.07759.15.0	EPBMWN3-A015H	97380
7.07759.16.0	EPBMWN4-R010H	96431
7.07759.17.0	EPBMWT5-D017H	94348
7.07759.18.0	EPBMWN5-D003H	92791
7.07759.20.0	EPBMFN4-V007H	93735
7.07759.21.0	EPBMFT5-T003H	91493
7.07759.22.0	EPBMFT5-V013H	96559
7.07759.23.0	EPBMFT5-V002H	97685
7.07759.24.0	EPBMFT5-V005H	93645
7.07759.25.0	EPBMFN4-D014H	92888
7.07759.26.0	EPBMFN5-D001H	95207
7.07759.27.0	EPBMFT5-V027H	94616
7.07759.28.0	EPBMFN4-D009H	96113
7.07759.29.0	EPBMFT5-V006H	94366
7.07759.30.0	EPBMFT5-V001P	93006
7.07759.30.0	EPBMFT5-V021H	95278
7.07759.31.0	EPBMFT5-D040H	97032
7.07759.32.0	EPBMFT5-V020H	90244
7.07759.33.0	EPBMFT5-D014H	95484
7.07759.34.0	EPBMFN4-D004H	91534
7.07759.36.0	EPBMFT5-D038H	96961
7.07759.38.0	EPBMFN5-D002P	91609
7.07759.38.0	EPBMFN5-D023H	97946
7.07759.41.0	EPBMFT6-A049H	93243
7.07759.42.0	EPBMWT6-A007H	93605
7.07759.43.0	EPBMFT5-V053H	95935
7.07759.44.0	EPBMWT6-V013H	92412
7.07759.45.0	EPBMFN4-V008H	95035
7.07759.46.0	EPBMWT3-D024H	91171
7.07759.47.0	EPBMFT5-T011H	92630
7.07759.48.0	EPBMWT4-A019H	94808
7.07759.49.0	EPBMFT4-V061H	94528
7.07759.52.0	EPBMFT5-T001D	94095
7.07759.53.0	EPBMWT4-A022H	93854
7.07759.55.0	EPBMWT4-A011H	90069
7.18221.04.0	EPBMFN4-D011H	94586
7.18221.51.0	EPBMWN6-D029H	90628
7.22184.14.0	EPBMWN5-D014H	96884
7.22184.16.0	EPBMWT5-V023H	95103
7.22184.20.0	EPBMFT6-A026H	93281
7.22184.22.0	EPBMWT4-A011H	90069
7.22184.22.0	EPBMWT4-A008H	90627
7.22184.23.0	EPBMWN6-A001D	91743
7.22184.24.0	EPBMWT4-A001D	95860
7.22184.25.0	EPBMWT4-V002D	95695
7.22184.26.0	EPBMWN4-A002D	91111
7.22184.29.0	EPBMWT4-A009H	92423
7.22184.30.0	EPBMWN4-V002H	92462
7.22184.31.0	EPBMWN4-A026H	97860





Industry

PIERBURG	→ NTK	Stock
7.22184.32.0	EPBMWN4-A011H	96418
7.22184.33.0	EPBMWN5-A028H	96181
7.22184.34.0	EPBMWN4-A025H	91852
7.22184.35.0	EPBMWN4-A012H	96882
7.22184.38.0	EPBMFN5-D033H	93804
7.22184.39.0	EPBMWT5-A025H	93777
7.22184.40.0	EPBMWN3-A016H	93176
7.22184.41.0	EPBMWT4-D014H	93236
7.22184.42.0	EPBMWN3-V031H	90825
7.22184.43.0	EPBMFN5-V005D	90496
7.22184.44.0	EPBMWN5-V005H	93291
7.22184.46.0	EPBMWN3-V009H	96875
7.22184.50.0	EPBMFN6-R030H	90274
7.22184.53.0	EPBMWN3-A007H	93658
7.22184.55.0	EPBMWT5-A004D	91831
7.22184.56.0	EPBMWN5-V004D	94183
7.22184.57.0	EPBMWT5-V012D	95034
7.22184.68.0	EPBMWT5-V013D	92480
7.22184.73.0	EPBMWN5-D006H	92698
7.22184.74.0	EPBMWN5-D027H	91976
7.22184.75.0	EPBMWT5-A027H	96756
7.22184.76.0	EPBMWT4-V003D	94395
7.22184.77.0	EPBMFN4-V017H	96226
7.22184.79.0	EPBMFT4-V004H	90957
7.22184.80.0	EPBMFN4-V026H	94497
7.22184.80.0	EPBMFN4-V010H	97588
7.22184.81.0	EPBMFN4-V020H	90971
7.22184.83.0	EPBMWT4-A026H	95537
7.22184.84.0	EPBMWT4-A028H	91236
7.22184.85.0	EPBMWN4-A024H	90997
7.22684.07.0	EPBMFN5-D004P	93343
7.22684.09.0	EPBMFT5-D036H	90481
7.22684.09.0	EPBMFN5-D004P	93343
7.22684.09.0	EPBMFT5-D023H	93770
7.22684.09.0	EPBMFT5-D016H	95579
7.22684.09.0	EPBMFT5-D009H	95803
7.22684.09.0	EPBMFT5-D018H	96224
7.22684.09.0	EPBMFT5-D003P	96835
7.22684.10.0	EPBMFT5-D005P	90557
7.22684.10.0	EPBMFT5-D032H	91598
7.22684.11.0	EPBMFT5-D025H	90977
7.22684.11.0	EPBMFT5-D015H	92304
7.22684.11.0	EPBMFT5-V001P	93006
7.22684.11.0	EPBMFT5-D012H	93496
7.22684.11.0	EPBMFT5-D060H	95878
7.22684.11.0	EPBMFT5-D003P	96835
7.22684.11.0	EPBMFT5-D041H	97661
7.22684.12.0	EPBMFT5-D034H	96295
7.22684.13.0	EPBMFN5-D002P	91609
7.22684.13.0	EPBMFN5-D016H	96999
7.22684.14.0	EPBMFT5-D005P	90557
7.22684.14.0	EPBMFN5-D022H	91168

PIERBURG	→ NTK	Stock
7.22684.14.0	EPBMFT5-D032H	91598
7.22684.14.0	EPBMFN5-D002P	91609
7.22684.14.0	EPBMFN5-D027H	94938
7.22684.14.0	EPBMFT5-D045H	95253
7.22684.14.0	EPBMFN5-D013H	96315
7.22684.14.0	EPBMFN5-D016H	96999
7.22684.15.0	EPBMFT5-D005P	90557
7.22684.15.0	EPBMFN5-D002P	91609
7.22684.15.0	EPBMFT5-D054H	94591
7.22684.15.0	EPBMFN5-D003H	95299
7.22684.15.0	EPBMFN5-D012H	96277
7.22684.16.0	EPBMFN5-D002P	91609
7.22684.16.0	EPBMFN5-D019H	95991
7.22684.17.0	EPBMFT5-D043H	90272
7.22684.17.0	EPBMFT5-D009H	95803
7.22684.17.0	EPBMFT5-D003P	96835
7.22684.18.0	EPBMFN5-D015H	90376
7.22684.18.0	EPBMFN5-D002P	91609
7.22684.18.0	EPBMFN5-D002H	91692
7.22684.18.0	EPBMFN5-D005H	92204
7.22684.18.0	EPBMFN5-D025H	94062
7.22701.05.0	EPBMFT5-V017H	90311
7.22701.05.0	EPBMFT5-V055H	91808
7.22701.05.0	EPBMFT5-V001P	93006
7.22701.05.0	EPBMFT5-V021H	95278
7.22701.05.0	EPBMFT5-V030H	96975
7.22701.08.0	EPBMFT5-V039H	90466
7.22701.08.0	EPBMFT5-V001P	93006
7.22701.08.0	EPBMFT5-V035H	94119
7.22701.08.0	EPBMFN5-V032H	95044
7.22701.08.0	EPBMFT5-V033H	95261
7.22701.08.0	EPBMFT5-V019H	96039
7.22701.08.0	EPBMFT5-V007H	97257
7.22701.09.0	EPBMFT5-V001P	93006
7.22701.09.0	EPBMFT5-V058H	93155
7.22701.09.0	EPBMFT5-V008H	93715
7.22701.09.0	EPBMFT5-V037H	95360
7.22701.09.0	EPBMFT5-V007H	97257
7.22701.09.0	EPBMFT5-V031H	97525
7.22701.10.0	EPBMFT5-V001P	93006
7.22701.10.0	EPBMFT5-V007H	97257
7.22701.11.0	EPBMFT5-V017H	90311
7.22701.11.0	EPBMFT5-V029H	90502
7.22701.11.0	EPBMFT5-V001P	93006
7.22701.11.0	EPBMFT5-V010H	96310
7.22701.11.0	EPBMFT5-V007H	97257
7.28342.06.0	EPBMFT5-A001H	93740
7.28342.10.0	EPBMFN5-A029H	90647
7.28342.11.0	EPBMWT5-A014D	90205
7.28342.12.0	EPBMWT5-A014D	90205
7.28342.12.0	EPBMWT5-A009D	97997
7.28342.13.0	EPBMWT5-A006D	91258





PIERBURG	→ NTK	Stock
7.28342.14.0	EPBMWT5-A014D	90205
7.28342.14.0	EPBMWT5-A011D	92781
7.28342.15.0	EPBMWT5-A014D	90205
7.28342.15.0	EPBMWT5-A005D	93145
7.28342.17.0	EPBMFT5-V002D	97692
SIDAT	→ NTK	Stock
38.600	EPBMWN4-A019H	92343
38.601	EPBMWT4-D014H	93236
38.602	EPBMWN4-A033H	97034
38.603	EPBMWN4-A011H	96418
38.605	EPBMWN4-A026H	97860
38.606	EPBMWN4-R010H	96431
38.607	EPBMWN4-A025H	91852
38.608	EPBMWT5-A003H	93842
38.609	EPBMWN5-A028H	96181
38.610	EPBMWN5-D014H	96884
38.611	EPBMWT5-D020H	97934
38.612	EPBMWT6-A001H	90144
38.614	EPBMFT6-A026H	93281
38.615	EPBMWT5-A005H	93383
38.616	EPBMWT4-V002H	92668
38.618	EPBMWT5-A004H	91200
38.619	EPBMWN4-A012H	96882
38.620	EPBMWN3-A022H	90965
38.622	EPBMWN3-A016H	93176
38.623	EPBMWN3-A022H	90965
38.624	EPBMWN4-D018H	96313
38.625	EPBMFT5-V029H	90502
38.626	EPBMFT5-V017H	90311
38.627	EPBMWT5-D012H	91007
38.628	EPBMFT5-V010H	96310
38.629	EPBMFT5-V013H	96559
38.630	EPBMFT5-V017H	90311
38.631	EPBMFT5-V055H	91808
38.631	EPBMFT5-V001P	93006
38.631	EPBMFT5-V030H	96975
38.633	EPBMFN4-A035H	97899
38.634	EPBMWN3-A020H	92225
38.635	EPBMWN3-A001H	97106
38.636	EPBMFN5-D005H	92204
38.637	EPBMFN5-D015H	90376
38.637	EPBMFN5-D002P	91609
38.638	EPBMWN6-D029H	90628
38.639	EPBMFN6-R030H	90274
38.642	EPBMFT5-V005H	93645
38.646	EPBMFT5-D009H	95803
38.646	EPBMFT5-D003P	96835
38.647	EPBMFT5-V001P	93006
38.647	EPBMFT5-V007H	97257
38.648	EPBMFT5-D005P	90557
38.649	EPBMFT5-V001P	93006
38.649	EPBMFT5-V007H	97257

SIDAT	→ NTK	Stock
38.650	EPBMFT5-V017H	90311
38.650	EPBMFT5-V001P	93006
38.652	EPBMFT5-V017H	90311
38.652	EPBMFT5-V001P	93006
38.653	EPBMFT5-V001P	93006
38.654	EPBMFT5-D005P	90557
38.654	EPBMFT5-D032H	91598
38.655	EPBMFT5-D005P	90557
38.655	EPBMFT5-D032H	91598
38.655	EPBMFT5-D045H	95253
38.656	EPBMFT5-D023H	93770
38.656	EPBMFT5-D003P	96835
38.657	EPBMWT4-A009H	92423
38.658	EPBMWN3-A015H	97380
38.659	EPBMWN5-D003H	92791
38.660	EPBMWN3-A021H	93365
38.661	EPBMWT5-D017H	94348
38.662	EPBMWT5-V021H	97091
38.663	EPBMFT5-D005P	90557
38.663	EPBMFT5-D024H	93373
38.663	EPBMFN5-D013H	96315
38.664	EPBMFN5-D002P	91609
38.664	EPBMFN5-D013H	96315
38.665	EPBMFT5-D005P	90557
38.666	EPBMWN3-A023H	91067
38.667	EPBMWT6-A006H	94034
38.668	EPBMFN5-D002P	91609
38.668	EPBMFN5-D002H	91692
38.670	EPBMFN5-D002P	91609
38.670	EPBMFN5-D016H	96999
38.671	EPBMFN5-D002P	91609
38.671	EPBMFN5-D012H	96277
38.672	EPBMFN5-A029H	90647
38.673	EPBMFT5-V001P	93006
38.673	EPBMFT5-V042H	94057
38.674	EPBMFN5-D018H	91462
38.674	EPBMFN5-D002P	91609
38.675	EPBMFN5-D002P	91609
38.675	EPBMFN5-D025H	94062
38.677	EPBMWN3-A017H	95114
38.678	EPBMWT4-A011H	90069
38.678	EPBMWT4-A008H	90627
38.679	EPBMWT4-A008H	90627
38.683	EPBMFT5-D015H	92304
38.683	EPBMFT5-V001P	93006
38.684	EPBMFT5-V029H	90502
38.684	EPBMFT5-V001P	93006
38.685	EPBMFT5-V017H	90311
38.685	EPBMFT5-V001P	93006
38.686	EPBMFT5-D009H	95803
38.686	EPBMFT5-D003P	96835
38.687	EPBMFT5-V001P	93006





Industry

SIDAT	→ NTK	Stock
38.689	EPBMFT5-V001P	93006
38.689	EPBMFT5-V008H	93715
38.692	EPBMFN4-A045H	92062
38.693	EPBMFT5-V001P	93006
38.693	EPBMFT5-V031H	97525
38.695	EPBMFT5-V001P	93006
38.695	EPBMFT5-V007H	97257
38.696	EPBMFT5-A052H	95671
38.697	EPBMFT5-D003P	96835
38.698	EPBMFN4-A039H	95306
38.699	EPBMFT5-V010H	96310
38.700	EPBMFT5-V001P	93006
38.700	EPBMFT5-V021H	95278
38.701	EPBMFN5-D002P	91609
38.701	EPBMFN5-D003H	95299
38.702	EPBMFT5-D012H	93496
38.704	EPBMFT5-V039H	90466
38.704	EPBMFT5-V001P	93006
38.705	EPBMFT5-V001P	93006
38.705	EPBMFT5-V010H	96310
38.707	EPBMFN4-A037H	94866
38.708	EPBMFT5-V001P	93006
38.708	EPBMFN5-V043H	93581
38.709	EPBMFT5-V008H	93715
38.710	EPBMFN5-D004P	93343
38.712	EPBMFT5-V008H	93715
38.713	EPBMFT5-D018H	96224
38.713	EPBMFT5-D003P	96835
38.715	EPBMFN4-D040H	96545
38.716	EPBMFN5-D002P	91609
38.716	EPBMFN5-D016H	96999
38.717	EPBMFN5-D022H	91168
38.717	EPBMFN5-D002P	91609
38.720	EPBMFT5-V001P	93006
38.720	EPBMFT5-V037H	95360
38.723	EPBMFT5-V058H	93155
38.724	EPBMFN4-A041H	97353
38.725	EPBMFT5-V017H	90311
38.725	EPBMFT5-V001P	93006
38.726	EPBMFN4-A039H	95306
38.727	EPBMFN5-D002P	91609
38.727	EPBMFN5-D019H	95991
38.729	EPBMFN4-A035H	97899
38.730	EPBMFN4-A044H	96776
38.733	EPBMFT5-D003P	96835
38.733	EPBMFT5-D041H	97661
38.734	EPBMFT5-V001P	93006
38.734	EPBMFN5-V032H	95044
38.734	EPBMFT5-V021H	95278
38.736	EPBMFN4-A046H	90609
38.737	EPBMFT5-D043H	90272
38.737	EPBMFT5-D003P	96835

SIDAT	→ NTK	Stock
38.742	EPBMFT5-D060H	95878
38.743	EPBMFT5-D036H	90481
38.743	EPBMFT5-D016H	95579
38.743	EPBMFT5-D003P	96835
38.744	EPBMFT5-V001P	93006
38.744	EPBMFT5-V007H	97257
38.745	EPBMFN3-A028H	94128
38.746	EPBMWN3-A007H	93658
38.748	EPBMFT5-A001H	93740
38.748	EPBMWT4-V002D	95695
38.757	EPBMWT5-D012H	91007
38.758	EPBMFN4-V026H	94497
38.758	EPBMFN4-V010H	97588
38.759	EPBMFT6-A044H	92490
38.760	EPBMFT5-V005H	93645
38.762	EPBMFT5-V001P	93006
38.762	EPBMFT5-V035H	94119
38.764	EPBMFN4-V026H	94497
38.764	EPBMFN4-V010H	97588
38.765	EPBMFT4-V004H	90957
38.765	EPBMFN4-V017H	96226
38.766	EPBMFN4-D011H	94586
38.767	EPBMFN4-D009H	96113
38.769	EPBMFT5-V017H	90311
38.770	EPBMFT5-V055H	91808
38.770	EPBMFT5-V030H	96975
38.771	EPBMFN4-V020H	90971
38.773	EPBMFT5-V017H	90311
38.773	EPBMFT5-V001P	93006
38.774	EPBMFN4-D009H	96113
38.775	EPBMFN4-D014H	92888
38.776	EPBMFT5-D059H	94271
38.777	EPBMFT5-V022H	93863
38.778	EPBMFT5-V029H	90502
38.778	EPBMFT5-V001P	93006
38.779	EPBMFT5-D005P	90557
38.779	EPBMFT5-D054H	94591
38.781	EPBMFT5-V001P	93006
38.782	EPBMFN5-D002P	91609
38.782	EPBMFN5-D027H	94938
38.783	EPBMFN4-D004H	91534
38.786	EPBMFN4-V007H	93735
38.787	EPBMFT5-V020H	90244
38.788	EPBMFT5-V027H	94616
38.789	EPBMFT5-D034H	96295
38.790	EPBMFT5-V001P	93006
38.790	EPBMFN5-V032H	95044
38.791	EPBMFT5-V017H	90311
38.791	EPBMFT5-V001P	93006
38.792	EPBMFT5-V001P	93006
38.792	EPBMFT5-V007H	97257
38.793	EPBMFT5-D009H	95803





SIDAT	→ NTK	Stock
38.793	EPBMFT5-D003P	96835
38.794	EPBMFT5-D005P	90557
38.794	EPBMFT5-D028H	93297
38.795	EPBMFN5-D021H	90140
38.796	EPBMFT5-V001P	93006
38.797	EPBMFT5-D038H	96961
38.799	EPBMFT4-D050H	94911
38.800	EPBMFT4-V048H	95493
38.803	EPBMWN6-V004H	96070
38.809	EPBMWN4-V002H	92462
38.810	EPBMWT6-A007H	93605
38.811	EPBMFT6-A049H	93243
38.812	EPBMWN5-V005H	93291
38.814	EPBMFN5-D002P	91609
38.814	EPBMFN5-D023H	97946
38.815	EPBMFT5-V033H	95261
38.816	EPBMWN3-V031H	90825
38.828	EPBMFT5-V002H	97685
38.832	EPBMFT5-V039H	90466
38.834	EPBMFN4-D004H	91534
38.835	EPBMFT5-V006H	94366
38.836	EPBMFT4-V004H	90957
38.839	EPBMWT5-V015H	92930
38.841	EPBMFT4-V061H	94528
38.843	EPBMFT4-V004H	90957
38.845	EPBMWT5-A014D	90205
38.845	EPBMWT5-A005D	93145
38.850	EPBMWN5-V008H	92710
38.851	EPBMWT5-V023H	95103
38.858	EPBMFT6-V046H	95763
38.859	EPBMFN5-D001H	95207
38.860	EPBMFN5-D033H	93804
38.861	EPBMWN5-D006H	92698
38.861	EPBMWN5-D003D	94436
38.870	EPBMFT5-T011H	92630
38.871	EPBMFT5-T003H	91493
38.874	EPBMWN3-V009H	96875
38.879	EPBMWT4-A026H	95537
38.881	EPBMFN4-D009H	96113
38.882	EPBMFN5-V005D	90496
38.888	EPBMFN4-V031H	96741
38.890	EPBMFT5-T011H	92630
38.891	EPBMFT5-T062H	91666
38.891	EPBMFT5-T001D	94095
38.892	EPBMWN5-D027H	91976
38.893	EPBMWN4-A024H	90997
38.896	EPBMWT6-V013H	92412
38.897	EPBMFN4-D014H	92888
38.900	EPBMFN4-V008H	95035
38.904	EPBMWT5-A025H	93777
38.905	EPBMWT4-A028H	91236
38.913	EPBMWT4-D018H	96715

SIDAT	→ NTK	Stock
38.914	EPBMWT4-A011H	90069
38.915	EPBMFN5-A038H	93095
38.933	EPBMFN5-V001D	95368
38.934	EPBMFT5-V053H	95935
38.935	EPBMFT5-D047H	97067
38.936	EPBMFT5-V001P	93006
38.936	EPBMFT5-V021H	95278
38.938	EPBMFT5-D040H	97032
38.945	EPBMFN5-D047H	91140
38.945	EPBMFN5-D002P	91609
38.950	EPBMWT4-A019H	94808
38.952	EPBMWT6-A001H	90144
38.954	EPBMWT3-D024H	91171
38.955	EPBMWT4-A022H	93854
38.956	EPBMWT5-A027H	96756
38.957	EPBMFN4-D014H	92888
38.962	EPBMFN4-V020H	90971
38.969	EPBMWT5-V010H	93933
38.971	EPBMFT5-A051H	90866
38.973	EPBMFT5-V002H	97685
38.989	EPBMFT5-D056H	90827
38.1003	EPBMFT4-V061H	94528
38.1022	EPBMFN5-V032H	95044
38.1024	EPBMFT5-V053H	95935
38.1047	EPBMFT5-V035H	94119
38.1066	EPBMFT4-V061H	94528
38.600A2	EPBMWN4-A019H	92343
38.601A2	EPBMWT4-D014H	93236
38.602A2	EPBMWN4-A033H	97034
38.603A2	EPBMWN4-A011H	96418
38.605A2	EPBMWN4-A026H	97860
38.607A2	EPBMWN4-A025H	91852
38.608A2	EPBMWT5-A003H	93842
38.609A2	EPBMWN5-A028H	96181
38.610A2	EPBMWN5-D014H	96884
38.611A2	EPBMWT5-D020H	97934
38.612A2	EPBMWT6-A001H	90144
38.614A2	EPBMFT6-A026H	93281
38.615A2	EPBMWT5-A005H	93383
38.616A2	EPBMWT4-V002H	92668
38.618A2	EPBMWT5-A004H	91200
38.619A2	EPBMWN4-A012H	96882
38.622A2	EPBMWN3-A016H	93176
38.623A2	EPBMWN3-A022H	90965
38.624A2	EPBMWN4-D018H	96313
38.625A2	EPBMFT5-V029H	90502
38.626A2	EPBMFT5-V017H	90311
38.627A2	EPBMWT5-D012H	91007
38.628A2	EPBMFT5-V010H	96310
38.629A2	EPBMFT5-V013H	96559
38.630A2	EPBMFT5-V017H	90311
38.631A2	EPBMFT5-V055H	91808





Industry

SIDAT	→ NTK	Stock
38.631A2	EPBMFT5-V001P	93006
38.631A2	EPBMFT5-V030H	96975
38.634A2	EPBMWN3-A020H	92225
38.635A2	EPBMWN3-A001H	97106
38.636A2	EPBMFN5-D005H	92204
38.637A2	EPBMFN5-D015H	90376
38.637A2	EPBMFN5-D002P	91609
38.638A2	EPBMWN6-D029H	90628
38.639A2	EPBMFN6-R030H	90274
38.646A2	EPBMFT5-D009H	95803
38.646A2	EPBMFT5-D003P	96835
38.647A2	EPBMFT5-V001P	93006
38.647A2	EPBMFT5-V007H	97257
38.648A2	EPBMFT5-D005P	90557
38.649A2	EPBMFT5-V001P	93006
38.649A2	EPBMFT5-V007H	97257
38.650A2	EPBMFT5-V017H	90311
38.650A2	EPBMFT5-V001P	93006
38.652A2	EPBMFT5-V017H	90311
38.652A2	EPBMFT5-V001P	93006
38.653A2	EPBMFT5-V001P	93006
38.654A2	EPBMFT5-D005P	90557
38.654A2	EPBMFT5-D032H	91598
38.655A2	EPBMFT5-D005P	90557
38.655A2	EPBMFT5-D032H	91598
38.655A2	EPBMFT5-D045H	95253
38.656A2	EPBMFT5-D023H	93770
38.656A2	EPBMFT5-D003P	96835
38.657A2	EPBMWT4-A009H	92423
38.658A2	EPBMWN3-A015H	97380
38.659A2	EPBMWN5-D003H	92791
38.660A2	EPBMWN3-A021H	93365
38.661A2	EPBMWT5-D017H	94348
38.663A2	EPBMFT5-D005P	90557
38.663A2	EPBMFT5-D024H	93373
38.663A2	EPBMFN5-D013H	96315
38.664A2	EPBMFN5-D002P	91609
38.664A2	EPBMFN5-D013H	96315
38.665A2	EPBMFT5-D005P	90557
38.666A2	EPBMWN3-A023H	91067
38.667A2	EPBMWT6-A006H	94034
38.668A2	EPBMFN5-D002P	91609
38.668A2	EPBMFN5-D002H	91692
38.670A2	EPBMFN5-D002P	91609
38.670A2	EPBMFN5-D016H	96999
38.671A2	EPBMFN5-D002P	91609
38.671A2	EPBMFN5-D012H	96277
38.672A2	EPBMFN5-A029H	90647
38.673A2	EPBMFT5-V001P	93006
38.673A2	EPBMFT5-V042H	94057
38.674A2	EPBMFN5-D018H	91462
38.674A2	EPBMFN5-D002P	91609

SIDAT	→ NTK	Stock
38.675A2	EPBMFN5-D002P	91609
38.675A2	EPBMFN5-D025H	94062
38.677A2	EPBMWN3-A017H	95114
38.678A2	EPBMWT4-A011H	90069
38.678A2	EPBMWT4-A008H	90627
38.683A2	EPBMFT5-D015H	92304
38.683A2	EPBMFT5-V001P	93006
38.684A2	EPBMFT5-V029H	90502
38.684A2	EPBMFT5-V001P	93006
38.685A2	EPBMFT5-V017H	90311
38.685A2	EPBMFT5-V001P	93006
38.687A2	EPBMFT5-V001P	93006
38.688A2	EPBMFT5-D025H	90977
38.688A2	EPBMFT5-D003P	96835
38.689A2	EPBMFT5-V001P	93006
38.689A2	EPBMFT5-V008H	93715
38.692A2	EPBMFN4-A045H	92062
38.693A2	EPBMFT5-V001P	93006
38.693A2	EPBMFT5-V031H	97525
38.695A2	EPBMFT5-V001P	93006
38.695A2	EPBMFT5-V007H	97257
38.696A2	EPBMFT5-A052H	95671
38.697A2	EPBMFT5-D003P	96835
38.698A2	EPBMFN4-A039H	95306
38.699A2	EPBMFT5-V010H	96310
38.700A2	EPBMFT5-V001P	93006
38.700A2	EPBMFT5-V021H	95278
38.701A2	EPBMFN5-D002P	91609
38.701A2	EPBMFN5-D003H	95299
38.702A2	EPBMFT5-D012H	93496
38.704A2	EPBMFT5-V039H	90466
38.704A2	EPBMFT5-V001P	93006
38.705A2	EPBMFT5-V001P	93006
38.705A2	EPBMFT5-V010H	96310
38.707A2	EPBMFN4-A037H	94866
38.708A2	EPBMFT5-V001P	93006
38.708A2	EPBMFN5-V043H	93581
38.709A2	EPBMFT5-V008H	93715
38.710A2	EPBMFN5-D004P	93343
38.712A2	EPBMFT5-V008H	93715
38.713A2	EPBMFT5-D018H	96224
38.713A2	EPBMFT5-D003P	96835
38.715A2	EPBMFN4-D040H	96545
38.716A2	EPBMFN5-D002P	91609
38.716A2	EPBMFN5-D016H	96999
38.724A2	EPBMFN4-A041H	97353
38.727A2	EPBMFN5-D002P	91609
38.727A2	EPBMFN5-D019H	95991
38.729A2	EPBMFN4-A035H	97899
38.730A2	EPBMFN4-A044H	96776
38.734A2	EPBMFT5-V001P	93006
38.734A2	EPBMFN5-V032H	95044





SIDAT	→ NTK	Stock
38.734A2	EPBMFT5-V021H	95278
38.736A2	EPBMFN4-A046H	90609
38.737A2	EPBMFT5-D043H	90272
38.737A2	EPBMFT5-D003P	96835
38.743A2	EPBMFT5-D036H	90481
38.743A2	EPBMFT5-D016H	95579
38.743A2	EPBMFT5-D003P	96835
38.744A2	EPBMFT5-V001P	93006
38.744A2	EPBMFT5-V007H	97257
38.745A2	EPBMFN3-A028H	94128
38.748A2	EPBMFT5-A001H	93740
38.748A2	EPBMWT4-V002D	95695
38.758A2	EPBMFN4-V026H	94497
38.758A2	EPBMFN4-V010H	97588
38.759A2	EPBMFT6-A044H	92490
38.760A2	EPBMFT5-V005H	93645
38.762A2	EPBMFT5-V001P	93006
38.762A2	EPBMFT5-V035H	94119
38.765A2	EPBMFT4-V004H	90957
38.765A2	EPBMFN4-V017H	96226
38.766A2	EPBMFN4-D011H	94586
38.769A2	EPBMFT5-V017H	90311
38.770A2	EPBMFT5-V055H	91808
38.770A2	EPBMFT5-V030H	96975
38.771A2	EPBMFN4-V020H	90971
38.773A2	EPBMFT5-V017H	90311
38.773A2	EPBMFT5-V001P	93006
38.775A2	EPBMFN4-D014H	92888
38.777A2	EPBMFT5-V022H	93863
38.778A2	EPBMFT5-V029H	90502
38.778A2	EPBMFT5-V001P	93006
38.779A2	EPBMFT5-D005P	90557
38.779A2	EPBMFT5-D054H	94591
38.783A2	EPBMFN4-D004H	91534
38.786A2	EPBMFN4-V007H	93735
38.788A2	EPBMFT5-V027H	94616
38.789A2	EPBMFT5-D034H	96295
38.791A2	EPBMFT5-V017H	90311
38.791A2	EPBMFT5-V001P	93006
38.792A2	EPBMFT5-V001P	93006
38.792A2	EPBMFT5-V007H	97257
38.793A2	EPBMFT5-D009H	95803
38.793A2	EPBMFT5-D003P	96835
38.797A2	EPBMFT5-D038H	96961
38.798A2	EPBMWN6-D030H	96504
38.799A2	EPBMFT4-D050H	94911
38.800A2	EPBMFT4-V048H	95493
38.803A2	EPBMWN6-V004H	96070
38.809A2	EPBMWN4-V002H	92462
38.810A2	EPBMWT6-A007H	93605
38.811A2	EPBMFT6-A049H	93243
38.812A2	EPBMWN5-V005H	93291

SIDAT	→ NTK	Stock
38.814A2	EPBMFN5-D002P	91609
38.814A2	EPBMFN5-D023H	97946
38.816A2	EPBMWN3-V031H	90825
38.828A2	EPBMFT5-V002H	97685
38.832A2	EPBMFT5-V039H	90466
38.834A2	EPBMFN4-D004H	91534
38.835A2	EPBMFT5-V006H	94366
38.836A2	EPBMFT4-V004H	90957
38.845A2	EPBMWT5-A014D	90205
38.845A2	EPBMWT5-A005D	93145
38.850A2	EPBMWN5-V008H	92710
38.858A2	EPBMFT6-V046H	95763
38.859A2	EPBMFN5-D001H	95207
38.860A2	EPBMFN5-D033H	93804
38.861A2	EPBMWN5-D006H	92698
38.861A2	EPBMWN5-D003D	94436
38.870A2	EPBMFT5-T011H	92630
38.871A2	EPBMFT5-T003H	91493
38.879A2	EPBMWT4-A026H	95537
38.881A2	EPBMFN4-D009H	96113
38.882A2	EPBMFN5-V005D	90496
38.891A2	EPBMFT5-T062H	91666
38.891A2	EPBMFT5-T001D	94095
38.892A2	EPBMWN5-D027H	91976
38.896A2	EPBMWT6-V013H	92412
38.900A2	EPBMFN4-V008H	95035
38.913A2	EPBMWT4-D018H	96715
38.914A2	EPBMWT4-A011H	90069
38.915A2	EPBMFN5-A038H	93095
38.936A2	EPBMFT5-V001P	93006
38.936A2	EPBMFT5-V021H	95278
38.954A2	EPBMWT3-D024H	91171
38.957A2	EPBMFN4-D014H	92888
38.962A2	EPBMFN4-V020H	90971
VALEO	→ NTK	Stock
253700	EPBMFN5-D002P	91609
253700	EPBMFN5-D002H	91692
253701	EPBMWT4-V002H	92668
253702	EPBMWT6-A001H	90144
253703	EPBMFN5-D002P	91609
253703	EPBMFN5-D003H	95299
253704	EPBMFT5-V001P	93006
253704	EPBMFT5-V007H	97257
253705	EPBMFT5-D005P	90557
253706	EPBMWT5-A003H	93842
253707	EPBMFT5-D025H	90977
253707	EPBMFT5-D003P	96835
253708	EPBMFN5-D018H	91462
253708	EPBMFN5-D002P	91609
253709	EPBMFN5-D002P	91609
253709	EPBMFN5-D025H	94062
253710	EPBMFN5-D002P	91609





Industry

VALEO	→ NTK	Stock
253710	EPBMFN5-D005H	92204
253711	EPBMFT5-V029H	90502
253711	EPBMFT5-V001P	93006
253712	EPBMFT5-D003P	96835
253712	EPBMFT5-D041H	97661
253713	EPBMFT5-V039H	90466
253713	EPBMFT5-V001P	93006
253713	EPBMFT5-V007H	97257
253714	EPBMFT5-D005P	90557
253714	EPBMFN5-D002P	91609
253714	EPBMFT5-D024H	93373
253714	EPBMFN5-D013H	96315
253715	EPBMFT5-V017H	90311
253715	EPBMFT5-V001P	93006
253716	EPBMFN5-D002P	91609
253716	EPBMFN5-D012H	96277
253717	EPBMFN4-D014H	92888
253718	EPBMWT5-A004H	91200
253719	EPBMFT5-D018H	96224
253719	EPBMFT5-D003P	96835
253720	EPBMFN5-D015H	90376
253720	EPBMFN5-D002P	91609
253721	EPBMFN5-D002P	91609
253721	EPBMFN5-D016H	96999
253722	EPBMFT5-V001P	93006
253722	EPBMFT5-V010H	96310
253723	EPBMWT6-A006H	94034
253724	EPBMFN5-D002P	91609
253724	EPBMFN5-D023H	97946
253725	EPBMFT5-D012H	93496
253726	EPBMFT5-D023H	93770
253726	EPBMFT5-D003P	96835
253727	EPBMFN4-V017H	96226
253728	EPBMFT5-D009H	95803
253728	EPBMFT5-D003P	96835
253729	EPBMFN5-D002P	91609
253729	EPBMFN5-D019H	95991
253730	EPBMFT5-D036H	90481
253730	EPBMFT5-D016H	95579
253730	EPBMFT5-D003P	96835
253731	EPBMFT5-D015H	92304
253731	EPBMFT5-V001P	93006
253732	EPBMFT5-V001P	93006
253732	EPBMFT5-V042H	94057
253732	EPBMFN5-V032H	95044
253732	EPBMFT5-V021H	95278
253733	EPBMFT5-D005P	90557
253733	EPBMFT5-D032H	91598
253733	EPBMFT5-D045H	95253
253735	EPBMFT5-D005P	90557
253735	EPBMFT5-D032H	91598
253736	EPBMFT5-D005P	90557

VALEO	→ NTK	Stock
253736	EPBMFT5-D028H	93297
253737	EPBMFN5-D022H	91168
253737	EPBMFN5-D002P	91609
253738	EPBMFN4-D004H	91534
253739	EPBMFT5-D043H	90272
253739	EPBMFT5-D003P	96835
253740	EPBMFT5-V001P	93006
253740	EPBMFT5-V042H	94057
253741	EPBMFN5-D027H	94938
253742	EPBMFT5-D005P	90557
253742	EPBMFT5-D054H	94591
253743	EPBMWT3-D024H	91171
253744	EPBMFN5-D047H	91140
253744	EPBMFN5-D002P	91609
253745	EPBMFN4-V026H	94497
253745	EPBMFN4-V010H	97588
253746	EPBMWN3-A001H	97106
253747	EPBMWT5-A005H	93383
253748	EPBMFT5-V001P	93006
253748	EPBMFT5-V031H	97525
253749	EPBMFT5-V001P	93006
253749	EPBMFT5-V008H	93715
253749	EPBMFT5-V019H	96039
253750	EPBMFT5-V055H	91808
253750	EPBMFT5-V001P	93006
253750	EPBMFT5-V030H	96975
253751	EPBMFT5-V001P	93006
253751	EPBMFT5-V037H	95360
366281	EPBMWT6-A007H	93605
366282	EPBMWT4-A001D	95860
366284	EPBMFT5-A001H	93740
366285	EPBMFN5-D004P	93343
366286	EPBMFT5-T003H	91493
366289	EPBMWN5-D003H	92791
366290	EPBMWT4-V002D	95695
366291	EPBMFN4-D011H	94586
366292	EPBMWT4-D014H	93236
366293	EPBMWT4-A009H	92423
366294	EPBMFT6-A044H	92490
366295	EPBMWT4-V003D	94395
366296	EPBMWT5-D017H	94348
366297	EPBMWN6-A001D	91743
366298	EPBMWT4-A011H	90069
366299	EPBMWT5-A014D	90205
366299	EPBMWT5-A005D	93145
366300	EPBMWN4-A002D	91111
366301	EPBMWN5-V005H	93291
366302	EPBMWT4-A008H	90627
366303	EPBMFT6-A026H	93281
366304	EPBMWT5-A004D	91831
366305	EPBMFN5-V005D	90496
366305	EPBMWN5-V005H	93291





VALEO	→ NTK	Stock
366306	EPBMFT5-V002H	97685
366307	EPBMWN4-V002H	92462
366308	EPBMWT5-A014D	90205
366308	EPBMWT5-A009D	97997
366309	EPBMWT4-D018H	96715
366310	EPBMWN3-A015H	97380
366311	EPBMFN4-V007H	93735
366312	EPBMFN4-A037H	94866
366313	EPBMFN5-D001H	95207
366315	EPBMFT5-T011H	92630
366316	EPBMWN6-D029H	90628
366318	EPBMWT4-A026H	95537
366319	EPBMWN3-A016H	93176
366320	EPBMFN5-D021H	90140
366321	EPBMWT4-A019H	94808
366322	EPBMWT5-D012H	91007
366324	EPBMWN4-A012H	96882
366325	EPBMFT4-V048H	95493
366327	EPBMFT6-V046H	95763
366328	EPBMWN3-V009H	96875
366329	EPBMFN4-V008H	95035
366331	EPBMWT5-V021H	97091
VEMO	→ NTK	Stock
V10-72-0049	EPBMFT5-D005P	90557
V10-72-0872	EPBMWT5-A027H	96756
V10-72-0953	EPBMWN6-D029H	90628
V10-72-0953-1	EPBMWN6-D029H	90628
V10-72-0958	EPBMFN5-D002P	91609
V10-72-0958	EPBMFN5-D005H	92204
V10-72-0959	EPBMFN5-D015H	90376
V10-72-0959	EPBMFN5-D002P	91609
V10-72-0960	EPBMFN5-D002P	91609
V10-72-0960	EPBMFN5-D012H	96277
V10-72-0960-1	EPBMFN5-D002P	91609
V10-72-0960-1	EPBMFN5-D012H	96277
V10-72-0961	EPBMWN3-A022H	90965
V10-72-0970	EPBMFT5-D005P	90557
V10-72-0970	EPBMFT5-D032H	91598
V10-72-0970	EPBMFT5-D045H	95253
V10-72-0974	EPBMFN5-D018H	91462
V10-72-0974	EPBMFN5-D002P	91609
V10-72-0974-1	EPBMFN5-D018H	91462
V10-72-0974-1	EPBMFN5-D002P	91609
V10-72-0975	EPBMFT5-D005P	90557
V10-72-0975-1	EPBMFT5-D005P	90557
V10-72-0976	EPBMFT5-D005P	90557
V10-72-0976	EPBMFT5-D024H	93373
V10-72-0976	EPBMFN5-D013H	96315
V10-72-0999	EPBMWN3-A022H	90965
V10-72-1015	EPBMWN5-D014H	96884
V10-72-1016	EPBMWN4-D018H	96313
V10-72-1016-1	EPBMWN4-D018H	96313

VEMO	→ NTK	Stock
V10-72-1017	EPBMWN3-A016H	93176
V10-72-1018	EPBMWT4-D014H	93236
V10-72-1018-1	EPBMWT4-D014H	93236
V10-72-1019	EPBMFT5-D005P	90557
V10-72-1020	EPBMFN5-D002P	91609
V10-72-1020	EPBMFN5-D016H	96999
V10-72-1021	EPBMFN5-D002P	91609
V10-72-1021	EPBMFN5-D023H	97946
V10-72-1022	EPBMFN4-A037H	94866
V10-72-1025	EPBMFN5-D015H	90376
V10-72-1025	EPBMFN5-D002P	91609
V10-72-1025	EPBMFN5-D005H	92204
V10-72-1025-1	EPBMFN5-D015H	90376
V10-72-1025-1	EPBMFN5-D002P	91609
V10-72-1025-1	EPBMFN5-D005H	92204
V10-72-1038	EPBMFN5-D047H	91140
V10-72-1038	EPBMFN5-D002P	91609
V10-72-1038	EPBMFN5-D002H	91692
V10-72-1045	EPBMFN4-A037H	94866
V10-72-1049	EPBMFN5-D002P	91609
V10-72-1049	EPBMFN5-D013H	96315
V10-72-1065	EPBMFT5-D005P	90557
V10-72-1065	EPBMFT5-D032H	91598
V10-72-1065	EPBMFN4-D040H	96545
V10-72-1066	EPBMWN3-A021H	93365
V10-72-1067	EPBMFN5-D002P	91609
V10-72-1067	EPBMFN5-D003H	95299
V10-72-1067-1	EPBMFN5-D002P	91609
V10-72-1067-1	EPBMFN5-D003H	95299
V10-72-1068	EPBMFN5-D002P	91609
V10-72-1068	EPBMFN5-D025H	94062
V10-72-1069	EPBMWN3-A007H	93658
V10-72-1070	EPBMFN4-A046H	90609
V10-72-1102	EPBMFT5-D005P	90557
V10-72-1102	EPBMFT5-D032H	91598
V10-72-1102	EPBMFT5-D045H	95253
V10-72-1205	EPBMFN5-D002P	91609
V10-72-1205	EPBMFN5-D019H	95991
V10-72-1216	EPBMFN5-D033H	93804
V10-72-1217	EPBMWT5-A025H	93777
V10-72-1219	EPBMFT5-D038H	96961
V10-72-1220	EPBMFT5-D014H	95484
V10-72-1221	EPBMFN5-D021H	90140
V10-72-1222	EPBMFT5-D040H	97032
V10-72-1222-1	EPBMFT5-D040H	97032
V10-72-1223	EPBMFN5-D001H	95207
V10-72-1256	EPBMFN5-D022H	91168
V10-72-1256	EPBMFN5-D002P	91609
V10-72-1274	EPBMFN4-V008H	95035
V10-72-1290	EPBMWT5-V013D	92480
V10-72-1295	EPBMFT5-D005P	90557
V10-72-1295	EPBMFT5-D028H	93297





Industry

VEMO	→ NTK	Stock
V10-72-1297	EPBMWN5-D006H	92698
V10-72-1298	EPBMWN5-D027H	91976
V10-72-1314	EPBMWT3-D024H	91171
V10-72-1399	EPBMWN5-D003D	94436
V10-72-1503	EPBMFT5-D005P	90557
V10-72-1503	EPBMFT5-D054H	94591
V20-72-0001	EPBMWN3-A001H	97106
V20-72-0001-1	EPBMWN3-A001H	97106
V20-72-0004	EPBMWN4-R010H	96431
V20-72-0005	EPBMFT5-D023H	93770
V20-72-0005	EPBMFT5-D003P	96835
V20-72-0006	EPBMWN3-A015H	97380
V20-72-0007	EPBMFT5-D036H	90481
V20-72-0007	EPBMFT5-D016H	95579
V20-72-0007	EPBMFT5-D003P	96835
V20-72-0008	EPBMFT5-D034H	96295
V20-72-0009	EPBMFN4-D011H	94586
V20-72-0010	EPBMFT5-D012H	93496
V20-72-0067	EPBMFN4-D009H	96113
V20-72-5134	EPBMFN4-V010H	97588
V20-72-5134-1	EPBMFN5-A038H	93095
V20-72-5140	EPBMWN6-D030H	96504
V20-72-5143	EPBMFT5-A051H	90866
V20-72-5144	EPBMFT5-D060H	95878
V20-72-5164	EPBMFN4-D004H	91534
V20-72-5164	EPBMFN4-D014H	92888
V20-72-5176	EPBMFT5-A051H	90866
V20-72-5177	EPBMWN6-V004H	96070
V20-72-5178	EPBMWN5-V004D	94183
V20-72-5181	EPBMFT5-T062H	91666
V20-72-5207	EPBMFT5-D056H	90827
V22-72-0004	EPBMWT5-A005H	93383
V22-72-0005	EPBMWT5-A004H	91200
V22-72-0012	EPBMWT4-A009H	92423
V22-72-0012-1	EPBMWT4-A009H	92423
V22-72-0014	EPBMWT6-A006H	94034
V22-72-0035	EPBMWT4-A011H	90069
V22-72-0035	EPBMWT4-A008H	90627
V22-72-0080	EPBMFN4-V020H	90971
V22-72-0128	EPBMWT4-A026H	95537
V22-72-0134	EPBMWT4-A011H	90069
V24-72-0002	EPBMWT5-A003H	93842
V24-72-0002-1	EPBMWT5-A003H	93842
V24-72-0003	EPBMFT5-V001P	93006
V24-72-0004	EPBMFT5-V017H	90311
V24-72-0004	EPBMFT5-V001P	93006
V24-72-0109	EPBMWN3-V009H	96875
V24-72-0110	EPBMFT5-V039H	90466
V24-72-0110	EPBMFT5-V001P	93006
V24-72-0112	EPBMFT4-V061H	94528
V24-72-0113	EPBMFT5-V001P	93006
V24-72-0113	EPBMFT5-V007H	97257

VEMO	→ NTK	Stock
V24-72-0114	EPBMFT4-V004H	90957
V24-72-0119	EPBMFT5-V001P	93006
V24-72-0138	EPBMFN4-V017H	96226
V24-72-0139	EPBMFT4-V061H	94528
V24-72-0222	EPBMFN4-V026H	94497
V24-72-0222	EPBMFN4-V010H	97588
V25-72-1001	EPBMWN4-A011H	96418
V25-72-1002	EPBMWN4-A012H	96882
V25-72-1003	EPBMWN4-A025H	91852
V25-72-1004	EPBMWN4-A026H	97860
V25-72-1005	EPBMWN5-A028H	96181
V25-72-1006	EPBMWN4-V032H	90737
V25-72-1006	EPBMWN4-A002D	91111
V25-72-1007	EPBMFT6-A026H	93281
V25-72-1015	EPBMFT5-A001H	93740
V25-72-1015	EPBMWT4-V002D	95695
V25-72-1015-1	EPBMFT5-A001H	93740
V25-72-1015-1	EPBMWT4-V002D	95695
V25-72-1021	EPBMWT4-V002D	95695
V25-72-1021-1	EPBMWT4-V002D	95695
V25-72-1022	EPBMWN4-V002H	92462
V25-72-1035	EPBMWN6-A001D	91743
V25-72-1059	EPBMWT4-A001D	95860
V25-72-1059-1	EPBMWT4-A001D	95860
V25-72-1060	EPBMFT4-V004H	90957
V25-72-1060	EPBMFN4-V017H	96226
V25-72-1096	EPBMFT5-V001P	93006
V25-72-1096	EPBMFT5-V021H	95278
V25-72-1096-1	EPBMFT5-V001P	93006
V25-72-1096-1	EPBMFT5-V021H	95278
V25-72-1189	EPBMWT4-V003D	94395
V26-72-0026	EPBMFT5-V001P	93006
V26-72-0026	EPBMFT5-V031H	97525
V26-72-0186	EPBMWN5-V004D	94183
V30-72-0001	EPBMFT5-D025H	90977
V30-72-0001	EPBMFT5-D003P	96835
V30-72-0001-1	EPBMFT5-D025H	90977
V30-72-0001-1	EPBMFT5-D003P	96835
V30-72-0002-1	EPBMFT5-D009H	95803
V30-72-0002-1	EPBMFT5-D003P	96835
V30-72-0003-1	EPBMFT5-D003P	96835
V30-72-0003-1	EPBMFT5-D041H	97661
V30-72-0004	EPBMFN4-D040H	96545
V30-72-0006	EPBMWT5-D017H	94348
V30-72-0006-1	EPBMWT5-D017H	94348
V30-72-0007	EPBMWN5-D003H	92791
V30-72-0007-1	EPBMWN5-D003H	92791
V30-72-0008	EPBMFT5-D043H	90272
V30-72-0008	EPBMFT5-D003P	96835
V30-72-0010	EPBMFN5-D004P	93343
V30-72-0011	EPBMFT5-D009H	95803
V30-72-0011	EPBMFT5-D003P	96835





VEMO	→ NTK	Stock
V30-72-0012	EPBMFT5-T001D	94095
V30-72-0012	EPBMFT5-D018H	96224
V30-72-0012	EPBMFT5-D003P	96835
V30-72-0014	EPBMFT5-D043H	90272
V30-72-0014	EPBMFT5-D036H	90481
V30-72-0014	EPBMWT5-D012H	91007
V30-72-0014	EPBMFT5-D015H	92304
V30-72-0014	EPBMFT5-V001P	93006
V30-72-0014	EPBMFN5-D004P	93343
V30-72-0014	EPBMFT5-D023H	93770
V30-72-0014	EPBMFT5-D016H	95579
V30-72-0014	EPBMFT5-D009H	95803
V30-72-0014	EPBMFT5-D018H	96224
V30-72-0014	EPBMFT5-D003P	96835
V30-72-0014	EPBMFT5-D041H	97661
V30-72-0015	EPBMFT4-V061H	94528
V30-72-0015	EPBMFT5-V027H	94616
V30-72-0016	EPBMFN4-D014H	92888
V30-72-0016-1	EPBMFN4-D014H	92888
V30-72-0017	EPBMFT5-D025H	90977
V30-72-0017	EPBMFT5-D012H	93496
V30-72-0017	EPBMFT5-D003P	96835
V30-72-0030	EPBMFN4-D014H	92888
V30-72-0031	EPBMFT5-D047H	97067
V30-72-0046	EPBMFT5-V027H	94616
V30-72-0046-1	EPBMFT5-V027H	94616
V30-72-0095	EPBMFN5-D004P	93343
V30-72-0095-1	EPBMFN5-D004P	93343
V30-72-0176	EPBMFT4-D050H	94911
V30-72-0737	EPBMFT5-D036H	90481
V30-72-0737	EPBMFT5-D016H	95579
V30-72-0737	EPBMFT5-D009H	95803
V30-72-0737	EPBMFT5-D003P	96835
V30-72-0835	EPBMFN4-D014H	92888
V30-72-0836	EPBMFN5-D002P	91609
V30-72-0836	EPBMFN5-D027H	94938
V38-72-0005	EPBMWN3-V031H	90825
V38-72-0006	EPBMFN5-V005D	90496
V38-72-0006	EPBMWN5-V005H	93291
V38-72-0006-1	EPBMFN5-V005D	90496
V38-72-0006-1	EPBMWN5-V005H	93291
V38-72-0008	EPBMFN5-A029H	90647
V38-72-0071	EPBMFT5-A052H	95671
V38-72-0073	EPBMFN5-V005D	90496
V38-72-0247	EPBMFN4-V010H	97588
V40-72-0339	EPBMFT5-V017H	90311
V40-72-0339	EPBMFT5-V001P	93006
V40-72-0340	EPBMWN4-A019H	92343
V40-72-0341	EPBMWT6-A001H	90144
V40-72-0341	EPBMWT4-V002H	92668
V40-72-0385	EPBMFT5-V017H	90311
V40-72-0385	EPBMFT5-V001P	93006

VEMO	→ NTK	Stock
V40-72-0385-1	EPBMFT5-V017H	90311
V40-72-0385-1	EPBMFT5-V001P	93006
V40-72-0386	EPBMFT5-V001P	93006
V40-72-0386	EPBMFT5-V007H	97257
V40-72-0387	EPBMWN3-V009H	96875
V40-72-0388	EPBMWT6-A001H	90144
V40-72-0388-1	EPBMWT6-A001H	90144
V40-72-0401	EPBMFT5-V001P	93006
V40-72-0401	EPBMFN5-V043H	93581
V40-72-0401	EPBMFT5-V019H	96039
V40-72-0401	EPBMFT5-V010H	96310
V40-72-0404	EPBMFT5-V001P	93006
V40-72-0404	EPBMFT5-V007H	97257
V40-72-0410	EPBMWT5-V021H	97091
V40-72-0411	EPBMWT5-V023H	95103
V40-72-0411	EPBMFT5-D038H	96961
V40-72-0417	EPBMFT5-V017H	90311
V40-72-0417	EPBMFT5-V029H	90502
V40-72-0417	EPBMFT5-V055H	91808
V40-72-0417	EPBMFT5-V001P	93006
V40-72-0417	EPBMFT5-V058H	93155
V40-72-0417	EPBMFT5-V008H	93715
V40-72-0417	EPBMFT5-V035H	94119
V40-72-0417	EPBMFN5-V032H	95044
V40-72-0417	EPBMFT5-V021H	95278
V40-72-0417	EPBMFT5-V037H	95360
V40-72-0417	EPBMFT5-V010H	96310
V40-72-0417	EPBMFT5-V030H	96975
V40-72-0417	EPBMFT5-V007H	97257
V40-72-0417-1	EPBMFT5-V017H	90311
V40-72-0417-1	EPBMFT5-V029H	90502
V40-72-0417-1	EPBMFT5-V055H	91808
V40-72-0417-1	EPBMFT5-V001P	93006
V40-72-0417-1	EPBMFT5-V058H	93155
V40-72-0417-1	EPBMFT5-V008H	93715
V40-72-0417-1	EPBMFT5-V035H	94119
V40-72-0417-1	EPBMFN5-V032H	95044
V40-72-0417-1	EPBMFT5-V021H	95278
V40-72-0417-1	EPBMFT5-V037H	95360
V40-72-0417-1	EPBMFT5-V010H	96310
V40-72-0417-1	EPBMFT5-V030H	96975
V40-72-0417-1	EPBMFT5-V007H	97257
V40-72-0449	EPBMFT5-V010H	96310
V40-72-0451	EPBMFT6-A044H	92490
V40-72-0455	EPBMWT5-V010H	93933
V40-72-0456	EPBMFT5-V001P	93006
V40-72-0456	EPBMFT5-V010H	96310
V40-72-0457	EPBMFT5-V001P	93006
V40-72-0457	EPBMFT5-V007H	97257
V40-72-0460	EPBMFT5-V029H	90502
V40-72-0460	EPBMFT5-V001P	93006
V40-72-0461	EPBMFT5-V017H	90311





Industry

VEMO	→ NTK	Stock
V40-72-0461	EPBMFT5-V001P	93006
V40-72-0461	EPBMWT4-A001D	95860
V40-72-0462	EPBMFN4-V026H	94497
V40-72-0462	EPBMFN4-V010H	97588
V40-72-0463	EPBMFT4-V061H	94528
V40-72-0464	EPBMFT5-V006H	94366
V40-72-0465	EPBMFT5-V035H	94119
V40-72-0474	EPBMFT5-T011H	92630
V40-72-0475	EPBMFT5-T003H	91493
V40-72-0476	EPBMFT5-V001P	93006
V40-72-0476	EPBMFT5-V008H	93715
V40-72-0477	EPBMWN3-V009H	96875
V40-72-0478	EPBMFN4-A045H	92062
V40-72-0484	EPBMFN4-V036H	95777
V40-72-0486	EPBMWN3-V009H	96875
V40-72-0574	EPBMFT5-V001P	93006
V40-72-0574	EPBMFT5-V022H	93863
V40-72-0574	EPBMFT5-V035H	94119
V40-72-0574	EPBMFT5-V010H	96310
V40-72-0582	EPBMFT5-T011H	92630
V40-72-0584	EPBMFT5-T001D	94095
V40-72-0584	EPBMFT4-V061H	94528
V40-72-0662	EPBMFN5-V001D	95368
V45-72-0031	EPBMFT5-D003P	96835
V45-72-0032	EPBMFT5-V001P	93006
V45-72-0048	EPBMFT5-V039H	90466
V45-72-0048	EPBMFT5-D015H	92304
V45-72-0048	EPBMFT5-V001P	93006
V45-72-0048	EPBMFT5-V042H	94057
V46-72-0005	EPBMWN4-A033H	97034
V46-72-0121	EPBMWT6-A007H	93605
V46-72-0147	EPBMFT6-A049H	93243
V46-72-0148	EPBMWT4-A019H	94808
V46-72-0149	EPBMWT4-A022H	93854
V46-72-0192	EPBMWT6-V013H	92412
V46-72-0212	EPBMFT6-V046H	95763
V48-72-0001	EPBMWN3-A001H	97106
V48-72-0040	EPBMFT5-D005P	90557
V51-72-0162	EPBMWT5-V023H	95103
V52-72-0002	EPBMWN3-A017H	95114
V52-72-0002-1	EPBMWN3-A017H	95114
V52-72-0015	EPBMFT5-V013H	96559
V52-72-0017	EPBMFT5-V017H	90311
V52-72-0017-1	EPBMFT5-V017H	90311
V52-72-0020	EPBMFT5-V017H	90311
V52-72-0021	EPBMFT5-V005H	93645
V52-72-0022	EPBMFT5-V002H	97685
V52-72-0032	EPBMWT5-D012H	91007
V52-72-0036	EPBMFT5-V010H	96310
V52-72-0130	EPBMFT5-V055H	91808
V52-72-0130	EPBMFT5-V001P	93006
V52-72-0130	EPBMFT5-V030H	96975

VEMO	→ NTK	Stock
V53-72-0001	EPBMFN3-A028H	94128
V53-72-0001-1	EPBMFN3-A028H	94128
V53-72-0013	EPBMFT5-V033H	95261
V53-72-0053	EPBMFN4-A035H	97899
V63-72-0004	EPBMWN5-V008H	92710
V70-72-0018	EPBMWT5-A014D	90205
V70-72-0019	EPBMWT5-A014D	90205
V70-72-0019	EPBMWT5-A009D	97997
V70-72-0020	EPBMWT5-A006D	91258
V70-72-0020-1	EPBMWT5-A006D	91258
V70-72-0020-1	EPBMFT4-V048H	95493
V70-72-0021	EPBMWT5-A014D	90205
V70-72-0021	EPBMWT5-A011D	92781
V70-72-0061	EPBMWT5-A014D	90205
V70-72-0061	EPBMWT5-A005D	93145
V70-72-0116	EPBMWT5-V012D	95034
V70-72-0117	EPBMWT5-A004D	91831
V70-72-0243	EPBMFT5-V002D	97692
V95-72-0007	EPBMWN3-A020H	92225
V95-72-0008	EPBMWT5-D020H	97934
V95-72-0011	EPBMFN6-A034H	91004
V95-72-0014	EPBMWN3-A023H	91067
V95-72-0031	EPBMFN5-A029H	90647
V95-72-0047	EPBMFT5-V001P	93006
V95-72-0047	EPBMWT5-A025H	93777
V95-72-0047	EPBMFT5-V021H	95278
V95-72-0047-1	EPBMFT5-V001P	93006
V95-72-0047-1	EPBMFT5-V021H	95278
V95-72-0052	EPBMFT5-V001P	93006
V95-72-0052	EPBMFT5-V042H	94057
V95-72-0052	EPBMFN5-V032H	95044
V95-72-0052	EPBMFT5-V021H	95278
V95-72-0120	EPBMFN5-V032H	95044
WALKER PRODUCTS → NTK	Stock	
245-1025	EPBMWN4-A011H	96418
245-1069	EPBMFN4-V036H	95777
245-1078	EPBMFN4-A046H	90609
245-1078	EPBMFN4-A037H	94866
245-1079	EPBMFT5-D043H	90272
245-1079	EPBMFT5-D005P	90557
245-1079	EPBMFT5-D025H	90977
245-1079	EPBMFN5-D002P	91609
245-1079	EPBMFT5-D003P	96835
245-1079	EPBMFN5-D023H	97946
245-1080	EPBMFN5-D002P	91609
245-1080	EPBMFN5-D025H	94062
245-1080	EPBMFN5-D012H	96277
245-1081	EPBMFT5-D005P	90557
245-1084	EPBMWN6-D029H	90628
245-1088	EPBMFT5-V017H	90311
245-1088	EPBMFT5-V001P	93006
245-1088	EPBMFT5-V042H	94057





WALKER PRODUCTS →	NTK	Stock
245-1088	EPBMFN5-V032H	95044
245-1088	EPBMFT5-V021H	95278
245-1089	EPBMWN3-A017H	95114
245-1090	EPBMFT5-V013H	96559
245-1091	EPBMWT5-D012H	91007
245-1095	EPBMWT5-A014D	90205
245-1095	EPBMWT5-A011D	92781
245-1095	EPBMWT5-A005D	93145
245-1095	EPBMWT5-A009D	97997
245-1096	EPBMFT5-D005P	90557
245-1096	EPBMFN5-D002P	91609
245-1096	EPBMFT5-D024H	93373
245-1096	EPBMFN5-D013H	96315
245-1096	EPBMFN5-D016H	96999
245-1108	EPBMWN6-A001D	91743
245-1110	EPBMFN5-D002P	91609
245-1110	EPBMFN5-D016H	96999
245-1111	EPBMFT5-V001P	93006
245-1111	EPBMFT5-V008H	93715
245-1112	EPBMFT5-D009H	95803
245-1112	EPBMFT5-D003P	96835
245-1114	EPBMFN5-D002P	91609
245-1114	EPBMFN5-D005H	92204
245-1117	EPBMFN5-V005D	90496
245-1119	EPBMFT5-D025H	90977
245-1119	EPBMFT5-D003P	96835
245-1120	EPBMWN3-A020H	92225
245-1120	EPBMWN3-A001H	97106
245-1123	EPBMFT5-D043H	90272
245-1123	EPBMFT5-D003P	96835
245-1124	EPBMFN4-A039H	95306
245-1128	EPBMWN5-V008H	92710
245-1130	EPBMFN4-A035H	97899
245-1142	EPBMWN3-A015H	97380
245-1144	EPBMFT5-V001P	93006
245-1144	EPBMFT5-V042H	94057
245-1144	EPBMFN5-V032H	95044
245-1144	EPBMFT5-V021H	95278
245-1146	EPBMWN4-R010H	96431
245-1148	EPBMFT5-V001P	93006
245-1148	EPBMFT5-V021H	95278
245-1150	EPBMWT5-A006D	91258
245-1156	EPBMWN3-V031H	90825
245-1163	EPBMWN4-D018H	96313
245-1172	EPBMFN3-A028H	94128
245-1173	EPBMFT5-D060H	95878
245-1174	EPBMWN6-V004H	96070
245-1180	EPBMFN4-D014H	92888
245-1193	EPBMFT6-A026H	93281
245-1198	EPBMWN3-A016H	93176
245-1202	EPBMWN3-A021H	93365
245-1203	EPBMWN3-A007H	93658

WALKER PRODUCTS →	NTK	Stock
245-1205	EPBMWT5-D017H	94348
245-1213	EPBMFN5-D002P	91609
245-1213	EPBMFN5-D003H	95299
245-1214	EPBMFN4-D040H	96545
245-1215	EPBMFN4-A041H	97353
245-1221	EPBMFT5-D038H	96961
245-1223	EPBMWN3-A023H	91067
245-1231	EPBMFT5-V027H	94616
245-1232	EPBMFN5-D015H	90376
245-1232	EPBMFN5-D002P	91609
245-1233	EPBMFN5-V032H	95044
245-1234	EPBMFT5-D003P	96835
245-1238	EPBMWT4-V002H	92668
245-1239	EPBMWT4-D014H	93236
245-1245	EPBMFN5-D021H	90140
245-1247	EPBMWN5-D003H	92791
245-1248	EPBMFN5-D002P	91609
245-1248	EPBMFN5-D002H	91692
245-1253	EPBMFT5-T011H	92630
245-1262	EPBMFT5-D056H	90827
245-1263	EPBMFT5-V035H	94119
245-1266	EPBMFT5-D003P	96835
245-1266	EPBMFT5-D041H	97661
245-1270	EPBMFN5-D004P	93343
245-1272	EPBMFT5-V001P	93006
245-1278	EPBMWT4-V002D	95695
245-1279	EPBMFT5-A052H	95671
245-1283	EPBMFT5-V001P	93006
245-1295	EPBMWN6-D030H	96504
245-1296	EPBMWN5-D014H	96884
245-1305	EPBMWT5-A003H	93842
245-1307	EPBMFT5-V001P	93006
245-1307	EPBMFT5-V007H	97257
245-1308	EPBMFT5-V039H	90466
245-1308	EPBMFT5-V001P	93006
245-1308	EPBMFT5-V007H	97257
245-1309	EPBMWT5-A004H	91200
245-1312	EPBMFT5-D012H	93496
245-1318	EPBMFT5-V017H	90311
245-1318	EPBMFT5-V001P	93006
245-1321	EPBMFT5-V001P	93006
245-1321	EPBMFT5-V007H	97257
245-1322	EPBMWN4-A019H	92343
245-1325	EPBMFT5-D036H	90481
245-1325	EPBMFT5-D016H	95579
245-1325	EPBMFT5-D003P	96835
245-1326	EPBMFN5-A029H	90647
245-1335	EPBMWT4-A009H	92423
245-1335	EPBMWT6-A006H	94034
245-1349	EPBMFT5-D023H	93770
245-1349	EPBMFT5-D003P	96835
245-1352	EPBMFT5-V017H	90311





Industry

WALKER PRODUCTS →	NTK	Stock
245-1352	EPBMFT5-V001P	93006
245-1360	EPBMWT6-A001H	90144
245-1364	EPBMWN4-A002D	91111
245-1367	EPBMFT5-A001H	93740
245-1373	EPBMFT6-A044H	92490
245-1379	EPBMWN4-A012H	96882
245-1380	EPBMWT5-A005H	93383
245-1411	EPBMFT5-D015H	92304
245-1411	EPBMFT5-V001P	93006
245-1416	EPBMFT5-V001P	93006
245-1416	EPBMFT5-V007H	97257
245-1425	EPBMFT5-T003H	91493
245-1432	EPBMFT5-V001P	93006
245-1432	EPBMFT5-V010H	96310
245-1437	EPBMFN4-D011H	94586
245-1438	EPBMWT4-A008H	90627
245-1440	EPBMFT5-V001P	93006
245-1440	EPBMFT5-V019H	96039
245-1441	EPBMFT5-V001P	93006
245-1442	EPBMWT4-A009H	92423
245-1445	EPBMWN4-A025H	91852
245-1446	EPBMFT5-D009H	95803
245-1446	EPBMFT5-D003P	96835
245-1452	EPBMWT4-A011H	90069
245-1455	EPBMFN5-D002P	91609
245-1455	EPBMFN5-D019H	95991
245-1456	EPBMWN5-A028H	96181
245-1467	EPBMFN4-A039H	95306
245-1469	EPBMFT5-V017H	90311
245-1469	EPBMFT5-V001P	93006
245-1471	EPBMFT5-V055H	91808
245-1471	EPBMFT5-V001P	93006
245-1471	EPBMFT5-V030H	96975
245-1474	EPBMFN5-D018H	91462
245-1474	EPBMFN5-D002P	91609
245-1475	EPBMFT5-V001P	93006
245-1475	EPBMFT5-V007H	97257
245-1477	EPBMFT5-V029H	90502
245-1477	EPBMFT5-V001P	93006
245-1478	EPBMFT5-V001P	93006
245-1478	EPBMFN5-V043H	93581
245-1480	EPBMWT4-A001D	95860
245-1483	EPBMWN3-A022H	90965
245-1485	EPBMFT5-V001P	93006
245-1485	EPBMFT5-V035H	94119
245-1486	EPBMWT5-D020H	97934
245-1487	EPBMWN4-A033H	97034
245-1489	EPBMWN3-A016H	93176
245-1490	EPBMFT5-D009H	95803
245-1490	EPBMFT5-D003P	96835
245-1491	EPBMFN5-D004P	93343
245-1492	EPBMWT5-V015H	92930

WALKER PRODUCTS →	NTK	Stock
245-1493	EPBMFT5-V010H	96310
245-1494	EPBMFT5-D034H	96295
245-1495	EPBMFT5-V039H	90466
245-1495	EPBMFT5-V001P	93006
245-1497	EPBMFT5-D005P	90557
245-1497	EPBMFT5-D032H	91598
245-1497	EPBMFT5-D045H	95253
245-1499	EPBMFT5-V029H	90502
245-1499	EPBMFT5-V001P	93006
245-1500	EPBMFN5-D022H	91168
245-1500	EPBMFN5-D002P	91609
245-1502	EPBMFN6-R030H	90274
245-1503	EPBMFT5-V017H	90311
245-1503	EPBMFT5-V001P	93006
245-1504	EPBMFT5-D005P	90557
245-1504	EPBMFT5-D032H	91598
245-1505	EPBMFT5-D005P	90557
245-1505	EPBMFT5-D054H	94591
245-1506	EPBMFN4-V026H	94497
245-1506	EPBMFN4-V010H	97588
245-1507	EPBMFT5-V017H	90311
245-1507	EPBMFT5-V001P	93006
245-1508	EPBMFT5-V033H	95261
245-1509	EPBMWT5-V021H	97091
245-1510	EPBMFT5-V039H	90466
245-1510	EPBMFT5-V001P	93006
245-1517	EPBMFT5-D059H	94271
245-1521	EPBMFT5-V001P	93006
245-1521	EPBMFT5-V037H	95360
245-1523	EPBMFT5-V010H	96310
245-1524	EPBMFT5-V022H	93863
245-1525	EPBMFT5-V017H	90311
245-1526	EPBMFT5-V055H	91808
245-1526	EPBMFT5-V030H	96975
245-1527	EPBMFT5-V020H	90244
245-1528	EPBMFN4-A045H	92062
245-1533	EPBMFT5-V001P	93006
245-1533	EPBMFT5-V042H	94057
245-1536	EPBMFT5-V055H	91808
245-1536	EPBMFT5-V030H	96975
245-1538	EPBMFT5-V001P	93006
245-1538	EPBMFT5-V031H	97525
245-1539	EPBMFN4-V020H	90971
245-1540	EPBMFT5-V001P	93006
245-1542	EPBMFN4-A044H	96776
245-1546	EPBMFN5-D002P	91609
245-1546	EPBMFN5-D027H	94938
245-1547	EPBMFT5-V008H	93715
245-1549	EPBMFT5-V001P	93006
245-1549	EPBMFT5-V007H	97257
245-1551	EPBMFT5-V017H	90311
245-1551	EPBMFT5-V001P	93006



WALKER PRODUCTS → NTK	Stock
245-1552	EPBMFT5-V008H 93715
245-1553	EPBMFT5-V039H 90466
245-1556	EPBMFT5-D005P 90557
245-1556	EPBMFT5-D028H 93297
245-1560	EPBMFT5-V039H 90466
245-1561	EPBMFT5-V033H 95261
245-2088	EPBMFT5-V001P 93006
245-2110	EPBMFN5-D004P 93343
245-3151	EPBMWN4-V032H 90737
DMA-0212	EPBMFN5-V005D 90496



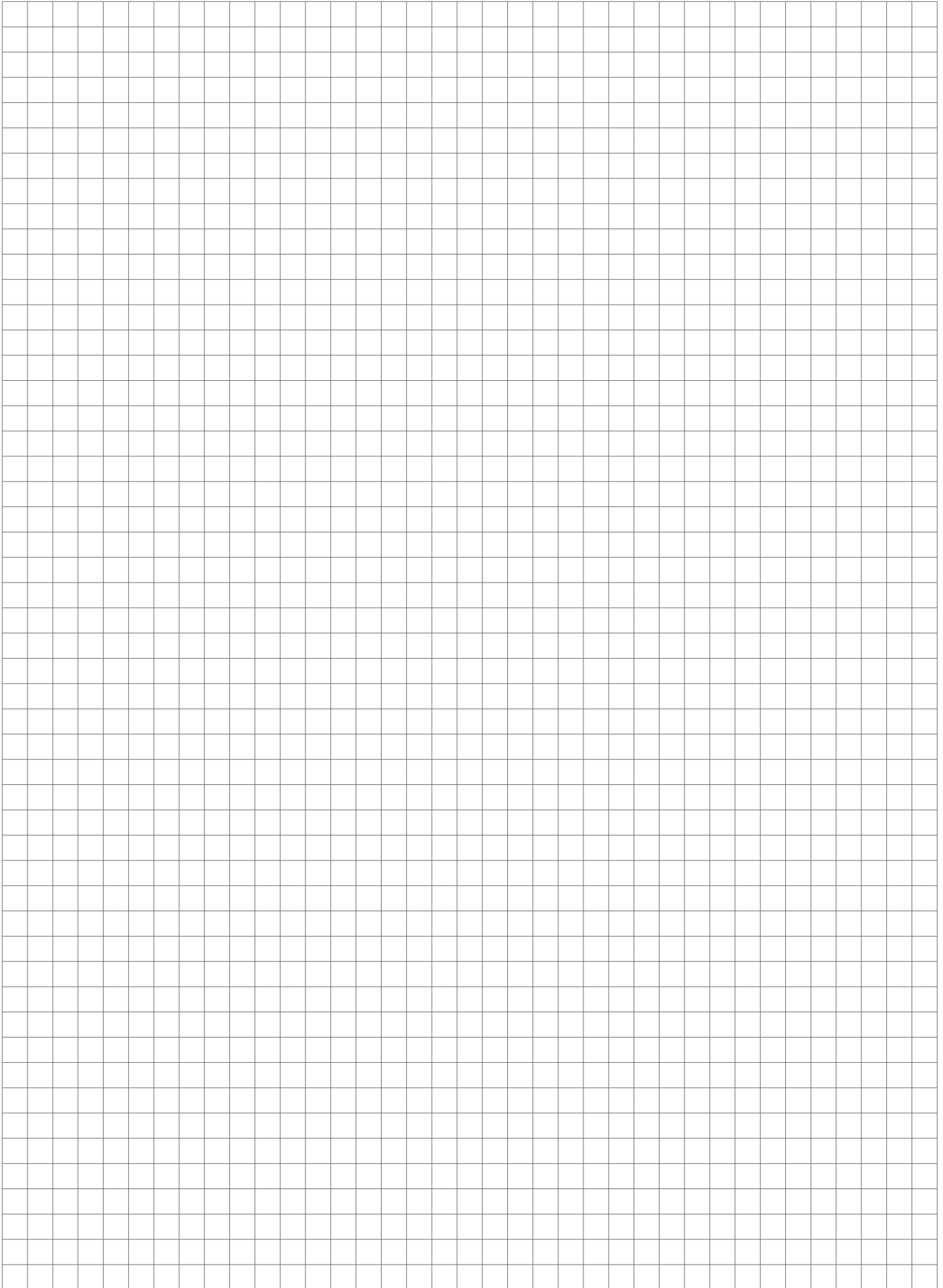

DISCONTINUED PRODUCTS



VEHICLE
ELECTRONICS















Old Stock No.	Old Type No.	New Stock No.	New Type No.
90609	EPBMFN4-A046H	/	/
90737	EPBMWN4-V032H	/	/
90965	EPBMWN3-A022H	/	/
91004	EPBMFN6-A034H	/	/
91176	EPBMFT5-V057H	/	/
91666	EPBMFT5-T062H	/	/
91852	EPBMWN4-A025H	/	/
92062	EPBMFN4-A045H	/	/
92225	EPBMWN3-A020H	/	/
92710	EPBMWN5-V008H	/	/
92781	EPBMWT5-A011D	90205	EPBMWT5-A014D
92930	EPBMWT5-V015H	/	/
93062	EPBMWN4-A013H	/	/
93155	EPBMFT5-V058H	/	/
94271	EPBMFT5-D059H	/	/
94343	EPBMWT5-A007D	97997	EPBMWT5-A009D
94672	EPBMFN4-V042H	/	/
94866	EPBMFN4-A037H	/	/
95293	EPBMWT5-D016H	91007	EPBMWT5-D012H
95306	EPBMFN4-A039H	/	/
95777	EPBMFN4-V036H	/	/
95925	EPBMWT5-A010D	93145	EPBMWT5-A005D
96181	EPBMWN5-A028H	/	/
96431	EPBMWN4-R010H	/	/
96528	EPBMFN5-D024H	93343	EPBMFN5-D004P
96776	EPBMFN4-A044H	/	/
97004	EPBMWT5-A008D	93145	EPBMWT5-A005D
97034	EPBMWN4-A033H	/	/
97353	EPBMFN4-A041H	/	/
97860	EPBMWN4-A026H	/	/
97997	EPBMWT5-A009D	90205	EPBMWT5-A014D







VEHICLE
ELECTRONICS

ABARTH



500 / 500C / 595 / 695 / 595C / 695C (312_)

1.4	1.368	99	4	05.2008-	312A1.000	 ; Euro 5	EPBBPT4-V010Z	91257	20	250
1.4	1.368	99	4	05.2008-	312A1.000	 ; Euro 5; Euro 6	EPBMPT4-V028Z	93902	11,2	250
1.4	1.368	99	4	08.2008-	312A1.000		EPBMBN3-V001Z	92099	20	256
1.4	1.368	99	4	05.2008-	312A1.000		EPBBPN3-V007Z	97073	20	300
1.4	1.368	103	4	05.2010-	312A3.000	 ; Position: Intake Manifold; Euro6	EPBMPT4-V028Z	93902	11,2	250
1.4	1.368	103	4	05.2010-	312A3.000		EPBMBN3-V001Z	92099	20	256
1.4	1.368	103	4	05.2010-	312A3.000		EPBBPN3-V007Z	97073	20	300
1.4	1.368	103	4	09.2009-	312A1.000, 312A3.000	 ; Euro 5	EPBBPT4-V010Z	91257	20	250
1.4	1.368	103	4	09.2009-	312A1.000, 312A3.000	 ; Euro 5	EPBMPT4-V028Z	93902	11,2	250
1.4	1.368	107	4	05.2016-	312B4.000	 ; Euro 5	EPBBPT4-V010Z	91257	20	250
1.4	1.368	107	4	05.2016-	312B4.000	 ; Euro 5	EPBMPT4-V028Z	93902	11,2	250
1.4	1.368	118	4	08.2008-	312A1.000, 312A3.000		EPBMBN3-V001Z	92099	20	256
1.4	1.368	118	4	08.2008-	312A1.000, 312A3.000		EPBBPT4-V001Z	92565	11	307
1.4	1.368	118	4	08.2008-	312A1.000, 312A3.000		EPBBPN3-V007Z	97073	20	300
1.4	1.368	118	4	07.2011-	312A1.000, 312A3.000		EPBMPT4-V028Z	93902	11,2	250
1.4	1.368	120	4	06.2016-	312B6.000		EPBMPT4-V028Z	93902	11,2	250
1.4	1.368	121	4	05.2016-	312B3.000	 ; Euro 5	EPBMPT4-V028Z	93902	11,2	250
1.4	1.368	132	4	06.2017-	312A3.000	 ; Euro 5; Euro 6	EPBMPT4-V028Z	93902	11,2	250
1.4	1.368	132	4	08.2008-	312A3.000		EPBBPT4-V010Z	91257	20	250
1.4	1.368	132	4	08.2008-	312A1.000, 312A3.000		EPBMBN3-V001Z	92099	20	256
1.4	1.368	132	4	08.2008-	312A1.000, 312A3.000		EPBBPT4-V001Z	92565	11	307
1.4	1.368	132	4	06.2010-	312A3.000		EPBBPN3-V007Z	97073	20	300
1.4	1.368	140	4	07.2011-	312A1.000, 312A9.000	 ; Euro 5	EPBMPT4-V028Z	93902	11,2	250
1.4	1.368	140	4	08.2008-	312A9.000	 ; Euro 5	EPBBPT4-V010Z	91257	20	250
1.4	1.368	140	4	08.2008-	312A1.000, 312A9.000		EPBMBN3-V001Z	92099	20	256

GRANDE PUNTO (199_)

1.4	1.368	114	4	12.2007- 06.2010	199A8.000		EPBMBN3-V001Z	92099	20	256
1.4	1.368	114	4	12.2007- 06.2010	199A8.000		EPBBPT4-V001Z	92565	11	307
1.4	1.368	114	4	12.2007- 06.2010	199A8.000		EPBBPN3-V007Z	97073	20	300
1.4	1.368	132	4	12.2007- 12.2012	199A8.000, 955A8.000		EPBMBN3-V001Z	92099	20	256
1.4	1.368	132	4	12.2007- 12.2012	199A8.000, 955A8.000		EPBBPT4-V001Z	92565	11	307
1.4	1.368	132	4	12.2007- 12.2012	199A8.000		EPBBPN3-V007Z	97073	20	300

PUNTO (199_)

1.4	1.368	120	4	03.2012-	955A8.000		EPBBPT4-V001Z	92565	11	307
1.4	1.368	120	4	03.2012-	955A8.000		EPBBPN3-V007Z	97073	20	300
1.4	1.368	132	4	03.2012-	199A8.000, 955A8.000		EPBBPN3-V007Z	97073	20	300

MAP



l kW
C
Y
I



Type-N°

Stock-N°

kPa from
kPa to

ACURA

NSX

R 3.0	2.977	188	6	01.1997-	C30A4		EPBMPN3-R046Z	95625	10	160
3.2	3.179	206	6	08.1997- 12.2005	C32B2		EPBMPN3-R046Z	95625	10	160

ALFA ROMEO

145 (930_)

1.6 i.e.	1.596	76	4	10.1994- 12.1996	AR33201		EPBMPN3-A003Z	92477	15	102
1.9 JTD	1.910	77	4	02.1999- 01.2001	AR32302		EPBBPN3-V034Z	96381	20	250

146 (930_)

1.6 i.e.	1.596	76	4	12.1994- 12.1996	AR33201		EPBMPN3-A003Z	92477	15	102
1.9 JTD	1.910	77	4	02.1999- 01.2001	AR32302		EPBBPN3-V034Z	96381	20	250

147 (937_)

1.9 JTD	1.910	74	4	06.2003- 03.2010	182B9.000		EPBMBN3-V001Z	92099	20	256
1.9 JTD	1.910	85	4	-07.2001	937A2.000		EPBBPN3-V034Z	96381	20	250
1.9 JTD	1.910	85	4	07.2001-	937A2.000		EPBMBN3-V001Z	92099	20	256
1.9 JTDM	1.910	85	4	10.2004- 03.2010	939A7.000		EPBBPT4-V001Z	92565	11	307
1.9 JTDM 8V	1.910	88	4	07.2005- 03.2010	937A3.000		EPBBPT4-V001Z	92565	11	307
1.9 JTD 16V	1.910	93	4	09.2003- 09.2004	937A4.000		EPBBPT4-V001Z	92565	11	307
1.9 JTD 16V	1.910	100	4	10.2004- 03.2010	192B1.000		EPBBPT4-V001Z	92565	11	307
1.9 JTD 16V	1.910	103	4	11.2002- 03.2010	192A5.000		EPBBPT4-V001Z	92565	11	307
1.9 JTDM 16V	1.910	110	4	09.2004- 03.2010	937A5.000		EPBBPT4-V001Z	92565	11	307

155 (167_)

2.0 16V Turbo Q4	1.995	137	4	01.1992- 12.1997	AR67203		EPBMPN3-A043Z	92940	20	250
2.0 16V Turbo Q4	1.995	140	4	03.1992- 12.1997	AR67203		EPBMPN3-A043Z	92940	20	250

156 / 156 SW (932_)

1.9 JTD	1.910	77	4	09.1997- 10.2000	AR32302		EPBBPN3-V034Z	96381	20	250
1.9 JTD	1.910	81	4	10.2000- 05.2001	AR37101	; Engine No.<2705194	EPBBPN3-V034Z	96381	20	250
1.9 JTD	1.910	81	4	10.2000- 05.2001	AR37101		EPBMBN3-V001Z	92099	20	256
1.9 JTD	1.910	85	4	05.2001- 05.2006	937A2.000		EPBMBN3-V001Z	92099	20	256
1.9 JTD	1.910	93	4	11.2003- 05.2006	937A4.000		EPBBPT4-V001Z	92565	11	307
1.9 JTD	1.910	100	4	11.2002- 11.2004	192B1.000		EPBBPT4-V001Z	92565	11	307
1.9 JTD 16V	1.910	103	4	11.2002- 05.2006	192A5.000		EPBBPT4-V001Z	92565	11	307
1.9 JTD 16V Q4	1.910	110	4	07.2004- 05.2006	937A5.000		EPBBPT4-V001Z	92565	11	307
2.4 JTD	2.387	100	5	09.1997- 09.2003	AR32501		EPBBPN3-V034Z	96381	20	250
2.4 JTD	2.387	103	5	10.2000- 05.2006	839A6.000		EPBBPN3-V034Z	96381	20	250
2.4 JTD	2.387	110	5	03.2002- 05.2006	841C000		EPBMBN3-V001Z	92099	20	256
2.4 JTD	2.387	129	5	10.2003- 05.2006	841G.000		EPBBPT4-V001Z	92565	11	307

159 / 159 SW (939_)

1.8 MPI	1.796	103	4	06.2005- 11.2011	939A4.000		EPBBPN3-V007Z	97073	20	300
1.8 Tbi	1.742	147	4	05.2009- 12.2012	939B1.000		EPBBPN3-V007Z	97073	20	300





Type-N°

Stock-N°

kPa from

kPa to

ALFA ROMEO

159 / 159 SW (939_)

1.9 JTDM 8V	1.910	88	4	09.2005-11.2011	939A1.000		EPBBPT4-V001Z	92565	11	307
1.9 JTDM 16V	1.910	100	4	09.2005-11.2011	937A8.000, 939A8.000		EPBBPT4-V001Z	92565	11	307
1.9 JTDM 16V	1.910	110	4	09.2005-11.2011	939A2.000		EPBBPT4-V001Z	92565	11	307
1.9 JTS	1.859	118	4	09.2005-11.2011	939A6.000		EPBBPT4-V001Z	92565	11	307
2.0 JTDM	1.956	100	4	06.2010-11.2011	939B4.000		EPBBPT4-V001Z	92565	11	307
2.0 JTDM	1.956	120	4	05.2009-11.2011	844A2.000		EPBBPT4-V001Z	92565	11	307
2.0 JTDM	1.956	125	4	05.2009-11.2011	939B3.000		EPBBPT4-V001Z	92565	11	307
2.4 JTDM	2.387	147	5	09.2005-11.2011	939A3.000		EPBBPT4-V001Z	92565	11	307
2.4 JTDM, 2.4 JTDM Q4	2.387	154	5	05.2007-12.2012	939A9.000		EPBBPT4-V001Z	92565	11	307
3.2 JTS, 3.2 JTS Q4	3.195	191	6	12.2005-11.2011	939A.000		EPBMPN3-V010Z	93991	10	117,5

166 (936_)

2.4 JTD	2.387	100	5	09.1998-10.2000	AR34202		EPBBPN3-V034Z	96381	20	250
2.4 JTD	2.387	103	5	10.2000-06.2007	839A6.000		EPBMBN3-V001Z	92099	20	256
2.4 JTD	2.387	110	5	04.2002-06.2007	841C000		EPBMBN3-V001Z	92099	20	256
2.4 JTD	2.387	129	5	10.2003-06.2007	841G.000, 841H.000		EPBBPT4-V001Z	92565	11	307
2.4 JTD	2.387	132	5	07.2006-06.2007	841M.000		EPBBPT4-V001Z	92565	11	307
2.4 JTD	2.387	136	5	07.2005-06.2007	841M.000, 936B.000		EPBBPT4-V001Z	92565	11	307

33 (907A_)

1.4 i.e.	1.351	65	4	06.1991-09.1994	AR30753, AR30755		EPBMPN3-A002Z	96249	15	100
1.4 i.e.	1.351	66	4	06.1991-09.1994	AR30753, AR30755		EPBMPN3-A002Z	96249	15	100

4C / 4C SPIDER (960_, 961_)

1.8	1.742	177	4	03.2013-	960A1.000		EPBBPN3-V007Z	97073	20	300
-----	-------	-----	---	----------	-----------	--	---------------	-------	----	-----

BRERA (939_)

2.4 JTDM 20V	2.387	147	5	01.2006-03.2011	939A3.000		EPBBPT4-V001Z	92565	11	307
2.4 JTDM 20V	2.387	154	5	05.2007-03.2011	939A9.000		EPBBPT4-V001Z	92565	11	307
3.2 JTS, 3.2 JTS Q4	3.195	191	6	01.2006-05.2011	939A.000		EPBMPN3-V010Z	93991	10	117,5

GIULIETTA (940_)

1.4 TB	1.368	77	4	04.2011-	940B1.000		EPBMBN3-V001Z	92099	20	256
1.4 TB	1.368	77	4	04.2011-	940B1.000, 940B8.000		EPBBPN3-V007Z	97073	20	300
1.4 TB	1.368	77	4	01.2013-	940B1.000, 940B8.000	; Position: Intake Manifold	EPBMPT4-V028Z	93902	11,2	250
1.4 TB	1.368	77	4	-12.2012	940B1.000, 940B8.000	; Position: Intake Manifold	EPBBPT4-V010Z	91257	20	250
1.4 TB	1.368	85	4	-06.2010	940A6.000	; Position: Intake Manifold	EPBBPT4-V010Z	91257	20	250
1.4 TB	1.368	85	4	01.2013-	940A6.000	; Position: Intake Manifold	EPBMPT4-V028Z	93902	11,2	250
1.4 TB	1.368	85	4	04.2010-02.2016	940A6.000		EPBMBN3-V001Z	92099	20	256
1.4 TB	1.368	85	4	06.2010-12.2012	940A6.000	; Position: Intake Manifold	EPBBPT4-V010Z	91257	20	250
1.4 TB	1.368	88	4	01.2013-	198A4.000, 940B7.000	; Position: Intake Manifold	EPBMPT4-V028Z	93902	11,2	250
1.4 TB	1.368	88	4	06.2010-12.2012	198A4.000, 940B7.000	; Position: Intake Manifold	EPBBPT4-V010Z	91257	20	250
1.4 TB	1.368	88	4	-06.2010	198A4.000, 940B7.000	; Position: Intake Manifold	EPBBPT4-V010Z	91257	20	250

MAP



l kW
C
Y
I



Type-N°

Stock-N°

kPa from
kPa to

ALFA ROMEO

GIULIETTA (940_)

1.4 BiFuel	1.368	88	4	12.2011-02.2017	198A4.000		EPBBPT4-V010Z	91257	20	250
1.4 BiFuel	1.368	88	4	12.2011-02.2017	198A4.000		EPBMBN3-V001Z	92099	20	256
1.4 BiFuel	1.368	88	4	12.2011-02.2017	198A4.000		EPBBPN3-V007Z	97073	20	300
1.4 TB	1.368	110	4	06.2017-	940A2.000, 940C2.000	; Euro 5; Euro 6	EPBMPT4-V028Z	93902	11,2	250
1.4 TB	1.368	120	4	04.2010-	955A8.000	; Position: Intake Manifold; Euro6	EPBMPT4-V028Z	93902	11,2	250
1.4 TB	1.368	120	4	04.2010-	955A8.000		EPBMBN3-V001Z	92099	20	256
1.4 TB	1.368	125	4	04.2010-	940A2.000	; Position: Intake Manifold; Euro6	EPBMPT4-V028Z	93902	11,2	250
1.4 TB	1.368	125	4	04.2010-	940A2.000		EPBMBN3-V001Z	92099	20	256
1.4 TB	1.368	125	4	04.2010-	940A2.000		EPBBPT4-V001Z	92565	11	307
1.4 TB	1.368	125	4	04.2010-	940A2.000		EPBBPN3-V007Z	97073	20	300
1.6 JTDM	1.598	77	4	04.2010-	940A3.000		EPBBPT4-V001Z	92565	11	307
1.8 Tbi	1.742	169	4	05.2010-	940A1.000		EPBBPN3-V007Z	97073	20	300
1.8 Tbi	1.742	173	4	04.2010-02.2016	940A1.000		EPBBPT4-V001Z	92565	11	307
1.8 Tbi	1.742	173	4	04.2010-02.2016	940A1.000		EPBBPN3-V007Z	97073	20	300
1.8 Tbi	1.742	177	4	09.2013-	940B2.000, 960A1.000		EPBBPN3-V007Z	97073	20	300
2.0 JTDM	1.956	100	4	04.2010-02.2016	940A8.000, 940B6.000, 940C4.000		EPBBPT4-V001Z	92565	11	307
2.0 JTDM	1.956	103	4	04.2010-	940A5.000, 940C3.000		EPBBPT4-V001Z	92565	11	307
2.0 JTDM	1.956	125	4	04.2010-	55283099, 940A4.000, 940B4.000		EPBBPT4-V001Z	92565	11	307

GT (937_)

1.9 JTD	1.910	110	4	11.2003-09.2010	937A5.000		EPBBPT4-V001Z	92565	11	307
1.9 JTD	1.910	125	4	05.2008-09.2010	937A6.000		EPBBPT4-V001Z	92565	11	307

MITO (955_)

0.9 TwinAir	875	63	2	07.2011-	312A2.000		EPBBPT4-V001Z	92565	11	307
1.3 MultiJet	1.248	66	4	08.2008-08.2010	199A3.000, 955B2.000		EPBBPT4-V001Z	92565	11	307
1.3 MultiJet	1.248	70	4	09.2009-12.2018	199B1.000, 330A1.000		EPBBPT4-V001Z	92565	11	307
1.4 Tjet	1.368	88	4	08.2008-	198A4.000		EPBBPT4-V010Z	91257	20	250
1.4 Tjet	1.368	88	4	08.2008-	198A4.000	; Transmission Type: 20-28KGM	EPBMBN3-V001Z	92099	20	256
1.4 Tjet	1.368	88	4	08.2008-	198A4.000		EPBBPN3-V007Z	97073	20	300
1.4 Bifuel	1.368	88	4	01.2009-	198A4.000		EPBBPT4-V010Z	91257	20	250
1.4 Bifuel	1.368	88	4	01.2009-	198A4.000	; Transmission Type: 20-28KGM	EPBMBN3-V001Z	92099	20	256
1.4 Bifuel	1.368	88	4	04.2016-	198A4.000		EPBBPT4-V010Z	91257	20	250
1.4 Turbo MultiAir	1.368	99	4	10.2009-	955A2.000, 955A7.000	; Transmission Type: 20-28KGM	EPBMBN3-V001Z	92099	20	256
1.4 Turbo MultiAir	1.368	99	4	10.2009-	955A2.000		EPBBPT4-V001Z	92565	11	307
1.4 Turbo MultiAir	1.368	99	4	10.2009-	955A2.000		EPBBPN3-V007Z	97073	20	300
1.4 TB	1.368	103	4	12.2013-	955B1.000	; Euro 5	EPBMPT4-V028Z	93902	11,2	250
1.4 TB	1.368	103	4	12.2013-	955B1.000	; Transmission Type: 20-28KGM	EPBMBN3-V001Z	92099	20	256



MAP



l kW
C
Y
I



Type-N°

Stock-N°

kPa from

kPa to

ALFA ROMEO

MITO (955_)

1.4 TB	1.368	103	4	12.2013-	955B1.000		EPBBPN3-V007Z	97073	20	300
1.4 Tjet	1.368	110	4	09.2008-06.2011	198A1.000		EPBBPT4-V010Z	91257	20	250
1.4 Tjet	1.368	110	4	09.2008-06.2011	198A1.000	; Transmission Type: 20-28KGM	EPBMBN3-V001Z	92099	20	256
1.4 Tjet	1.368	114	4	08.2008-06.2011	199A8.000		EPBBPT4-V010Z	91257	20	250
1.4 Tjet	1.368	114	4	08.2008-06.2011	199A8.000	; Transmission Type: 20-28KGM	EPBMBN3-V001Z	92099	20	256
1.4 Tjet	1.368	114	4	08.2008-06.2011	199A8.000		EPBBPN3-V007Z	97073	20	300
1.4 Turbo MultiAir	1.368	120	4	10.2009-	955A8.000	; Transmission Type: 20-28KGM	EPBMBN3-V001Z	92099	20	256
1.4 Turbo MultiAir	1.368	120	4	10.2009-	955A8.000		EPBBPT4-V001Z	92565	11	307
1.4 Turbo MultiAir	1.368	120	4	10.2009-	955A8.000		EPBBPN3-V007Z	97073	20	300
1.4 MultiAir	1.368	125	4	09.2009-	940A2.000	; Transmission Type: 20-28KGM	EPBMBN3-V001Z	92099	20	256
1.4 MultiAir	1.368	125	4	09.2009-	940A2.000		EPBBPT4-V001Z	92565	11	307
1.4 MultiAir	1.368	125	4	09.2009-	940A2.000		EPBBPN3-V007Z	97073	20	300
1.6 JTDM	1.598	88	4	08.2008-	198A2.000, 955A3.000		EPBBPT4-V001Z	92565	11	307

SPIDER (939_)

1.8 Tbi	1.742	147	4	05.2009-03.2011	939B1.000		EPBBPN3-V007Z	97073	20	300
2.0 JTDM	1.956	125	4	05.2009-06.2010	939B3.000		EPBBPT4-V001Z	92565	11	307
2.4 JTDM	2.387	147	5	03.2006-03.2011	939A3.000		EPBBPT4-V001Z	92565	11	307
2.4 JTDM	2.387	154	5	03.2008-03.2011	939A3.000		EPBBPT4-V001Z	92565	11	307
3.2 JTS, 3.2 JTS Q4	3.195	191	6	03.2006-03.2011	939A.000		EPBMPN3-V010Z	93991	10	117,5

ASTON MARTIN

CYGNET

1.3	1.329	72	4	04.2011-10.2013	1NR-FE		EPBMPT4-A030Z	96501	10	130
-----	-------	----	---	-----------------	--------	--	---------------	-------	----	-----

AUDI

100 C4 (4A2)

S4 V8 quattro	4.172	206	8	10.1992-07.1994	ABH		EPBMPN4-D019Z	91102	16,9	116,9
---------------	-------	-----	---	-----------------	-----	--	---------------	-------	------	-------

80 B4 (8C2, 8C5)

1.9 TDI	1.896	66	4	07.1993-	1Z		EPBMPN3-A027Z	90915	20	105
---------	-------	----	---	----------	----	--	---------------	-------	----	-----

A1 (8X1, 8XK, 8XA, 8XF)

1.0 TFSI	999	60	3	01.2016-10.2018	CHZE		EPBMPN4-V040Z	95972	20	115
1.0 TFSI	999	70	3	03.2015-10.2018	CHZB, DKLD		EPBBPT4-V002Z	95912	20	300
1.0 TFSI	999	70	3	03.2015-10.2018	CHZB, DKLD		EPBMPN4-V040Z	95972	20	115
1.4 TFSI	1.390	90	4	05.2010-04.2015	CAXA, CNVA		EPBBPT4-V003Z	91742	20	254
1.4 TFSI	1.395	92	4	11.2014-10.2018	CZCA, CZDD	; Position: Intake Manifold; After turbocharger	EPBBPT4-V002Z	95912	20	300
1.4 TFSI	1.395	103	4	04.2012-04.2015	CPTA		EPBBPT4-V002Z	95912	20	300
1.4 TSI	1.395	110	4	11.2014-10.2018	CZEA	; Position: Intake Manifold; After turbocharger	EPBBPT4-V002Z	95912	20	300
1.4 TFSI	1.390	136	4	01.2011-04.2015	CAVG, CTHG, CTJA		EPBBPT4-V002Z	95912	20	300
1.6 TDI	1.598	66	4	03.2011-04.2015	CAYB		EPBBPT4-V002Z	95912	20	300



MAP



l kW
C
Y
I



Type-N°

Stock-N°

kPa from
kPa to

AUDI

A1 (8X1, 8XK, 8XA, 8XF)

1.6 TDI	1.598	77	4	05.2010-04.2015	CAYC	; NTC Sensor	EPBBPT4-V002Z	95912	20	300
1.8 TFSI	1.798	141	4	02.2015-10.2018	DAJB		EPBBPT4-V002Z	95912	20	300
2.0 TDI	1.968	100	4	05.2012-04.2015	CFHB		EPBBPT4-V002Z	95912	20	300
2.0 TDI	1.968	105	4	09.2011-04.2015	CFHD		EPBBPT4-V002Z	95912	20	300
S1 quattro	1.984	170	4	03.2014-10.2018	CWZA		EPBBPT4-V002Z	95912	20	300
2.0 TFSI quattro	1.984	188	4	03.2012-11.2012	CDLH		EPBBPT4-V002Z	95912	20	300

A2 (8Z0)

1.2 TDI	1.191	45	3	03.2001-08.2005	ANY	; Chass.<8Z-2-027000	EPBMBT4-D001Z	91628	11	254
1.2 TDI	1.191	45	3	03.2001-08.2005	ANY	; Chass.>8Z-2-027001	EPBBPT4-V003Z	91742	20	254
1.4	1.390	55	4	02.2000-08.2005	AUA, BBY		EPBMPT4-V004Z	92899	20	115
1.4 TDI	1.422	55	3	02.2000-08.2005	AMF	; Chass.<8Z-2-027000	EPBMBT4-D001Z	91628	11	254
1.4 TDI	1.422	55	3	02.2000-08.2005	AMF, BHC	; Chass.>8Z-2-027001	EPBBPT4-V003Z	91742	20	254
1.4 TDI	1.422	66	3	11.2003-08.2005	ATL		EPBBPT4-V002Z	95912	20	300

A3 (8L1)

1.9 TDI	1.896	66	4	09.1996-07.2001	AGR, ALH		EPBMBT4-D001Z	91628	11	254
1.9 TDI	1.896	74	4	10.2000-05.2003	ATD		EPBMBT4-D001Z	91628	11	254
1.9 TDI	1.896	74	4	10.2000-05.2003	AXR		EPBBPT4-V003Z	91742	20	254
1.9 TDI	1.896	81	4	08.1997-07.2001	AHF, ASV		EPBMBT4-D001Z	91628	11	254
1.9 TDI, 1.9 TDI quattro	1.896	96	4	08.2000-05.2003	ASZ		EPBBPT4-V002Z	95912	20	300
S3 quattro	1.781	154	4	03.1999-04.2002	AMK	; Chass.<8L-1-080000	EPBMBT4-D001Z	91628	11	254
S3 quattro	1.781	154	4	03.1999-04.2002	AMK	; Chass.>8L-1-080000	EPBBPN4-V014Z	93428	20	250
S3 quattro	1.781	165	4	10.2001-05.2003	BAM		EPBBPN4-V014Z	93428	20	250

A3 (8P1, 8PA, 8P7)

1.4 TFSI	1.390	92	4	09.2007-05.2013	CAXC, CMSA	; NTC Sensor	EPBBPT4-V003Z	91742	20	254
1.6 TDI	1.598	66	4	05.2009-08.2012	CAYB		EPBBPT4-V002Z	95912	20	300
1.6	1.595	75	4	05.2003-03.2013	BGU, BSE, BSF	; NTC Sensor	EPBMPT4-D005Z	93653	17	117
1.6 E-Power	1.595	75	4	01.2011-03.2013	CCSA, CMXA		EPBMPT4-V008Z	96201	10	117
1.6 TDI	1.598	77	4	05.2009-05.2013	CAYC		EPBBPT4-V002Z	95912	20	300
1.8 TFSI, 1.8 TFSI quattro	1.798	118	4	11.2006-05.2013	BYT, BZB, CDAA	; With Charger Intercooler	EPBBPN4-V014Z	93428	20	250
1.9 TDI	1.896	77	4	05.2003-05.2010	BKC, BLS, BXE		EPBBPT4-V003Z	91742	20	254
2.0 TDI, 2.0 TDI quattro	1.968	100	4	05.2003-08.2012	AZV, CBAA, CFFA		EPBBPT4-V002Z	95912	20	300
2.0 TDI	1.968	103	4	06.2005-06.2008	BMM		EPBBPT4-V002Z	95912	20	300
2.0 TDI	1.968	103	4	04.2008-05.2013	CBAB, CFFB	; NTC Sensor	EPBBPT4-V002Z	95912	20	300
2.0 TDI 16V, 2.0 TDI 16V quattro	1.968	103	4	05.2003-03.2013	BKD, CBAB, CFFB, CLJA		EPBBPT4-V002Z	95912	20	300
2.0 TDI quattro	1.968	103	4	01.2006-06.2008	BMM		EPBBPT4-V002Z	95912	20	300
2.0 FSI	1.984	110	4	05.2003-06.2008	AXW, BLR, BLX, BLY, BMB, BVY, BVZ	; NTC Sensor	EPBMPT4-D005Z	93653	17	117
2.0 TDI	1.968	120	4	06.2006-06.2008	BUY		EPBBPT4-V002Z	95912	20	300



MAP



l kW
C
Y
I



Type-N°

Stock-N°

kPa from

kPa to

AUDI

A3 (8P1, 8PA, 8P7)

2.0 TDI, 2.0 TDI quattro	1.968	125	4	03.2006-03.2013	BMN, CBBB, CFGB		EPBBPT4-V002Z	95912	20	300
2.0 TFSI	1.984	147	4	09.2004-03.2013	AXX, BPY, BWA, CAWB, CBFA, CCTA, CCZA		EPBBPT4-V002Z	95912	20	300
2.0 TFSI, 2.0 TFSI quattro	1.984	147	4	09.2004-03.2013	AXX, BWA, CCZA, CBFA	; With Charger Intercooler	EPBBPN4-V014Z	93428	20	250
S3 quattro	1.984	188	4	02.2007-03.2013	BZC, CDLC		EPBBPT4-V002Z	95912	20	300
S3 quattro	1.984	195	4	11.2006-03.2013	BHZ, CDLA		EPBBPT4-V002Z	95912	20	300
RS3 quattro	2.480	250	5	01.2011-12.2012	CEPA		EPBBPT4-V002Z	95912	20	300

A3 (8V1, 8VK, 8V7, 8VE, 8VS, 8VM, 8VA, 8VF)

1.2 TFSI	1.197	77	4	02.2013-	CJZA	; After turbocharger	EPBBPT4-V002Z	95912	20	300
1.2 TFSI	1.197	81	4	05.2014-	CYVB	; After turbocharger	EPBBPT4-V002Z	95912	20	300
1.4 TFSI g-tron	1.395	81	4	11.2013-	CPWA		EPBBPT4-V002Z	95912	20	300
1.4 TFSI	1.395	90	4	04.2012-	CMBA, CXSA	; After turbocharger	EPBBPT4-V002Z	95912	20	300
1.4 TFSI	1.395	92	4	02.2014-	CXSB, CZCA	; After turbocharger	EPBBPT4-V002Z	95912	20	300
1.4 TFSI	1.395	103	4	03.2013-	CPTA		EPBBPT4-V002Z	95912	20	300
1.4 TFSI e-tron	1.395	110	4	05.2014-	CUKB, CXUA		EPBBPT4-V002Z	95912	20	300
1.4 TSI	1.395	110	4	05.2014-	CZEA	; After turbocharger	EPBBPT4-V002Z	95912	20	300
1.8 TFSI	1.798	125	4	05.2014-	CNSB		EPBBPT4-V002Z	95912	20	300
1.8 TFSI, 1.8 TFSI quattro	1.798	132	4	04.2012-	CJSA, CJSB		EPBBPT4-V002Z	95912	20	300
S3 quattro	1.984	206	4	02.2013-	CJXB		EPBBPT4-V002Z	95912	20	300
S3 quattro	1.984	210	4	03.2014-	CJXF		EPBBPT4-V002Z	95912	20	300
S3 quattro	1.984	221	4	11.2012-	CJXC, DNUE		EPBBPT4-V002Z	95912	20	300
RS3 quattro	2.480	270	5	03.2015-	CZGB		EPBBPT4-V002Z	95912	20	300

A4 ALLROAD B8 (8KH)

2.0 TDI quattro	1.968	100	4	09.2009-05.2016	CAGB, CJCB, CSUB		EPBBPT4-V002Z	95912	20	300
2.0 TDI quattro	1.968	100	4	09.2009-05.2016	CAGB, CJCB, CSUB		EPBMPN4-D019Z	91102	16,9	116,9
2.0 TDI quattro	1.968	105	4	09.2009-05.2016	CAGA, CJCA		EPBBPT4-V002Z	95912	20	300
2.0 TDI quattro	1.968	105	4	09.2009-05.2016	CAGA, CJCA		EPBMPN4-D019Z	91102	16,9	116,9
2.0 TDI quattro	1.968	110	4	05.2013-05.2016	CJCD, CSUA		EPBBPT4-V002Z	95912	20	300
2.0 TDI quattro	1.968	110	4	05.2014-04.2016	CSUA		EPBMPN4-D019Z	91102	16,9	116,9
2.0 TDI quattro	1.968	120	4	04.2009-05.2016	CAHB, CGLD, CNHC		EPBBPT4-V002Z	95912	20	300
2.0 TDI quattro	1.968	120	4	04.2009-05.2016	CAHB, CGLD, CNHC		EPBMPN4-D019Z	91102	16,9	116,9
2.0 TDI quattro	1.968	125	4	04.2009-05.2016	CAHA		EPBBPT4-V002Z	95912	20	300
2.0 TDI quattro	1.968	125	4	04.2009-05.2016	CAHA		EPBMPN4-D019Z	91102	16,9	116,9
2.0 TDI quattro	1.968	130	4	11.2011-05.2016	CGLC		EPBBPT4-V002Z	95912	20	300
2.0 TDI quattro	1.968	140	4	09.2013-05.2016	CNHA		EPBMPN4-D019Z	91102	16,9	116,9
2.0 TFSI quattro	1.984	155	4	04.2009-05.2016	CDNC, CPMA		EPBMPN4-D019Z	91102	16,9	116,9
2.0 TFSI quattro	1.984	165	4	05.2013-05.2016	CNCD		EPBBPT4-V002Z	95912	20	300
3.0 TDI quattro	2.967	176	6	04.2009-01.2012	CCWA		EPBBPT4-V002Z	95912	20	300



MAP



l kW
C
Y
I



Type-N°

Stock-N°

kPa from
kPa to

AUDI

A4 ALLROAD B8 (8KH)

3.0 TDI quattro	2.967	176	6	04.2009-01.2012	CCWA		EPBMPN4-D019Z	91102	16,9	116,9
3.0 TDI quattro	2.967	180	6	01.2012-05.2016	CDUC, CKVB, CKVC		EPBBPT4-V002Z	95912	20	300

A4 B5 (8D2, 8D5)

1.8 T, 1.8 T quattro	1.781	110	4	06.2000-10.2000	AWT		EPBMPN4-D019Z	91102	16,9	116,9
S4 quattro	2.671	195	6	10.1997-	AGB, AZB		EPBMPN4-D019Z	91102	16,9	116,9
RS4 quattro	2.671	280	6	05.2000-09.2001	ASJ, AZR		EPBMPN4-D019Z	91102	16,9	116,9

A4 B6 (8E2, 8E5, 8H7)

1.6	1.595	75	4	11.2000-12.2004	ALZ		EPBMPN4-D019Z	91102	16,9	116,9
1.8 T, 1.8 T quattro	1.781	110	4	-06.2002	AVJ		EPBMPN4-D019Z	91102	16,9	116,9
1.8 T, 1.8 T quattro	1.781	120	4	07.2002-12.2004	BFB		EPBMPN4-D019Z	91102	16,9	116,9
1.8 T Convertible, 1.8T Convertible quattro	1.781	120	4	07.2002-03.2009	BFB	; With Charger Intercooler	EPBBPN4-V014Z	93428	20	250
1.8 T, 1.8 T quattro	1.781	140	4	11.2002-12.2004	BEX		EPBMPN4-D019Z	91102	16,9	116,9
1.9 TDI	1.896	74	4	05.2001-12.2004	AVB		EPBBPT4-V003Z	91742	20	254
1.9 TDI	1.896	85	4	06.2004-12.2004	BKE		EPBBPT4-V003Z	91742	20	254
2.0	1.984	96	4	11.2000-12.2005	ALT		EPBMPT4-V011Z	91119	20	115
2.0	1.984	96	4	11.2000-12.2004	ALT		EPBMPN4-D019Z	91102	16,9	116,9
2.0 FSI	1.984	110	4	07.2002-12.2004	AWA		EPBMPT4-V011Z	91119	20	115
2.0 FSI	1.984	110	4	07.2002-12.2004	AWA		EPBMPN4-D019Z	91102	16,9	116,9
2.4	2.393	120	6	09.2001-12.2005	AMM		EPBMPN4-D019Z	91102	16,9	116,9
2.4	2.393	125	6	09.2001-12.2005	BDV		EPBMPN4-D019Z	91102	16,9	116,9
2.5 TDI	2.496	114	6	08.2001-07.2002	AYM		EPBBPT4-V003Z	91742	20	254
2.5 TDI	2.496	120	6	07.2002-12.2005	BCZ, BDG, BFC		EPBBPT4-V003Z	91742	20	254
2.5 TDI quattro	2.496	132	6	11.2000-12.2004	AKE, BAU, BDH		EPBBPT4-V003Z	91742	20	254
3.0, 3.0 quattro	2.976	160	6	04.2001-12.2005	BBJ		EPBMPN4-D019Z	91102	16,9	116,9
3.0, 3.0 quattro	2.976	162	6	12.2000-12.2005	ASN, AVK		EPBMPN4-D019Z	91102	16,9	116,9
S4 quattro	4.163	253	8	03.2003-12.2004	BBK		EPBMPN4-D019Z	91102	16,9	116,9

A4 B7 (8EC, 8ED, 8HE)

1.6	1.595	75	4	11.2004-06.2008	ALZ		EPBMPN4-D019Z	91102	16,9	116,9
1.8 T, 1.8 T quattro	1.781	120	4	11.2004-06.2008	BFB		EPBBPN4-V014Z	93428	20	250
1.8 T, 1.8 T quattro	1.781	120	4	11.2004-06.2008	BFB		EPBMPN4-D019Z	91102	16,9	116,9
1.9 TDI	1.896	85	4	11.2004-06.2008	BKE, BRB		EPBBPT4-V003Z	91742	20	254
2.0 TDI	1.968	89	4	09.2005-09.2006	BVG		EPBBPT4-V002Z	95912	20	300
2.0 TDI	1.968	93	4	11.2005-11.2006	BVF		EPBBPT4-V002Z	95912	20	300
2.0	1.984	96	4	11.2004-06.2008	ALT		EPBMPN4-D019Z	91102	16,9	116,9
2.0 TDI	1.968	100	4	11.2004-06.2008	BNA, BRF		EPBBPT4-V002Z	95912	20	300
2.0 TDI Convertible	1.968	100	4	01.2006-03.2009	BRC		EPBBPT4-V002Z	95912	20	300
2.0 TDI	1.968	103	4	11.2004-06.2008	BPW		EPBBPT4-V002Z	95912	20	300



MAP



kW
C
Y
I



Type-N°

Stock-N°

kPa from

kPa to

AUDI

A4 B7 (8EC, 8ED, 8HE)

2.0 TDI 16V	1.968	103	4	11.2004-06.2008	BLB, BRE		EPBBPT4-V002Z	95912	20	300
2.0 TDI	1.968	120	4	06.2006-06.2008	BVA		EPBBPT4-V002Z	95912	20	300
2.0 TDI, 2.0 TDI quattro	1.968	125	4	06.2006-06.2008	BRD		EPBBPT4-V002Z	95912	20	300
2.0 TFSI	1.984	125	4	10.2006-06.2008	BPJ		EPBMPN4-D019Z	91102	16,9	116,9
2.0 TFSI	1.984	125	4	10.2006-06.2008	BPJ, BYK		EPBBPN4-V014Z	93428	20	250
2.0 TFSI, 2.0 TFSI quattro	1.984	147	4	11.2004-06.2008	BGB, BPG		EPBMPN4-D019Z	91102	16,9	116,9
2.0 TFSI, 2.0 TFSI quattro	1.984	147	4	11.2004-06.2008	BGB, BWE, BWT, BPG		EPBBPN4-V014Z	93428	20	250
2.0 TFSI, 2.0 TFSI quattro	1.984	162	4	06.2005-06.2008	BUL		EPBBPN4-V014Z	93428	20	250
2.0 TFSI, 2.0 TFSI quattro	1.984	162	4	06.2005-06.2008	BUL		EPBMPN4-D019Z	91102	16,9	116,9
2.5 TDI	2.496	120	6	11.2004-05.2006	BDG		EPBBPT4-V003Z	91742	20	254
2.7 TDI	2.698	120	6	11.2005-06.2008	BSG		EPBBPT4-V002Z	95912	20	300
2.7 TDI	2.698	132	6	01.2006-03.2009	BPP		EPBBPT4-V002Z	95912	20	300
3.0 TDI quattro	2.967	150	6	11.2004-03.2009	BKN		EPBBPT4-V002Z	95912	20	300
3.0, 3.0 quattro	2.976	160	6	11.2004-05.2006	BBJ		EPBMPN4-D019Z	91102	16,9	116,9
3.0 TDI quattro	2.967	171	6	01.2006-03.2009	ASB		EPBBPT4-V002Z	95912	20	300
3.2 FSI, 3.2 FSI quattro	3.123	188	6	01.2005-03.2009	AUK, BKH		EPBMPT4-V008Z	96201	10	117
3.2 FSI, 3.2 FSI quattro	3.123	188	6	01.2005-03.2009	AUK, BKH		EPBMPN4-D019Z	91102	16,9	116,9
S4 quattro	4.163	253	8	11.2004-06.2008	BBK, BHF		EPBMPN4-D019Z	91102	16,9	116,9
RS4 quattro	4.163	309	8	09.2005-03.2009	BNS		EPBMPN4-D019Z	91102	16,9	116,9

A4 B8 (8K2, 8K5)

1.8 TFSI	1.798	88	4	01.2008-12.2015	CABA, CDHA		EPBMPN4-D019Z	91102	16,9	116,9
1.8 TFSI, 1.8 TFSI quattro	1.798	118	4	11.2007-03.2012	CABB, CDHB		EPBMPN4-D019Z	91102	16,9	116,9
1.8 TFSI, 1.8 TFSI quattro	1.798	125	4	11.2011-12.2015	CJEB	; After turbocharger	EPBBPT4-V002Z	95912	20	300
2.0 TDI	1.968	88	4	06.2008-12.2015	CAGC, CJCC		EPBBPT4-V002Z	95912	20	300
2.0 TDI	1.968	88	4	06.2008-12.2015	CAGC, CJCC		EPBMPN4-D019Z	91102	16,9	116,9
2.0 TDI	1.968	100	4	11.2007-12.2015	CAGB, CJCB, CSUB		EPBBPT4-V002Z	95912	20	300
2.0 TDI	1.968	100	4	11.2007-12.2015	CAGB, CJCB, CSUB		EPBMPN4-D019Z	91102	16,9	116,9
2.0 TDI, 2.0 TDI quattro	1.968	105	4	11.2007-12.2015	CAGA, CJCA, CMEA, CMFA		EPBBPT4-V002Z	95912	20	300
2.0 TDI, 2.0 TDI quattro	1.968	105	4	11.2007-12.2015	CAGA, CJCA, CMEA, CMFA		EPBMPN4-D019Z	91102	16,9	116,9
2.0 TDI, 2.0 TDI quattro	1.968	110	4	05.2013-12.2015	CJCD, CMFB, CSUA	; After turbocharger	EPBBPT4-V002Z	95912	20	300
2.0 TDI	1.968	120	4	08.2008-12.2015	CAHB, CGLD, CNHC		EPBBPT4-V002Z	95912	20	300
2.0 TDI	1.968	120	4	08.2008-12.2015	CAHB, CGLD, CNHC		EPBMPN4-D019Z	91102	16,9	116,9
2.0 TDI, 2.0 TDI quattro	1.968	125	4	01.2008-03.2012	CAHA		EPBBPT4-V002Z	95912	20	300
2.0 TDI, 2.0 TDI quattro	1.968	125	4	01.2008-03.2012	CAHA		EPBMPN4-D019Z	91102	16,9	116,9
2.0 TDI, 2.0 TDI quattro	1.968	130	4	11.2011-12.2015	CGLC, CMGB		EPBBPT4-V002Z	95912	20	300
2.0 TFSI	1.984	132	4	06.2008-12.2015	CAEA, CDNB, CFKA		EPBMPN4-D019Z	91102	16,9	116,9



MAP



l kW C
Y I



Type-N°

Stock-N°

kPa from
kPa to

AUDI

A4 B8 (8K2, 8K5)

2.0 TFSI flexible fuel, 2.0 TFSI flexible fuel quattro	1.984	132	4	11.2009-12.2015	CFKA		EPBMPN4-D019Z	91102	16,9	116,9
2.0 TFSI, 2.0 TFSI quattro	1.984	155	4	06.2008-12.2015	CAEB, CDNC		EPBMPN4-D019Z	91102	16,9	116,9
2.0 TFSI, 2.0 TFSI quattro	1.984	165	4	05.2013-12.2015	CNCD		EPBBPT4-V002Z	95912	20	300
2.7 TDI	2.698	120	6	11.2007-03.2012	CAMB, CGKB		EPBBPT4-V002Z	95912	20	300
2.7 TDI	2.698	120	6	06.2008-03.2012	CAMB, CGKB		EPBMPN4-D019Z	91102	16,9	116,9
2.7 TDI	2.698	140	6	11.2007-03.2012	CAMA, CGKA		EPBBPT4-V002Z	95912	20	300
2.7 TDI	2.698	140	6	11.2007-03.2012	CAMA, CGKA		EPBMPN4-D019Z	91102	16,9	116,9
3.0 TDI	2.967	150	6	11.2011-12.2015	CLAB		EPBBPT4-V002Z	95912	20	300
3.0 TDI quattro	2.967	155	6	06.2008-05.2010	CCWB		EPBBPT4-V002Z	95912	20	300
3.0 TDI quattro	2.967	155	6	06.2008-05.2010	CCWB		EPBMPN4-D019Z	91102	16,9	116,9
3.0 TDI quattro	2.967	176	6	11.2007-03.2012	CAPA, CCLA, CCWA		EPBBPT4-V002Z	95912	20	300
3.0 TDI quattro	2.967	176	6	11.2007-03.2012	CAPA, CCLA, CCWA		EPBMPN4-D019Z	91102	16,9	116,9
3.0 TDI quattro	2.967	180	6	11.2011-12.2015	CDUC, CKVB, CKVC		EPBBPT4-V002Z	95912	20	300
3.0 TFSI quattro	2.995	200	6	02.2012-12.2015	CMUA, CRED	; Before turbocharger	EPBMPT4-V008Z	96201	10	117
3.2 FSI, 3.2 FSI quattro	3.197	195	6	11.2007-03.2012	CALA		EPBMPT4-V008Z	96201	10	117
3.2 FSI, 3.2 FSI quattro	3.197	195	6	11.2007-03.2012	CALA		EPBMPN4-D019Z	91102	16,9	116,9
S4 quattro	2.995	245	6	11.2008-12.2015	CAKA, CBBA, CGWC, CGXC, CREC, CTUB		EPBMPN4-D019Z	91102	16,9	116,9
S4 quattro	2.995	245	6	11.2008-12.2015	CAKA, CGWC, CGXC, CREC	; ; before turbocharger	EPBMPT4-V008Z	96201	10	117
RS4 Avant quattro	4.163	331	8	05.2012-08.2015	CFSA		EPBMPT4-V008Z	96201	10	117
RS4 Avant quattro	4.163	331	8	05.2012-08.2015	CFSA		EPBMPN4-D019Z	91102	16,9	116,9

A4 B9 (8W2, 8W5, 8WC, 8WD)

1.4 TFSI	1.395	110	4	08.2015-11.2019	CVNA		EPBBPT4-V002Z	95912	20	300
----------	-------	-----	---	-----------------	------	--	---------------	-------	----	-----

A5 (8TA, 8T3, 8F7)

1.8 TFSI	1.798	106	4	09.2014-01.2017	CJED		EPBBPT4-V002Z	95912	20	300
1.8 TFSI	1.798	118	4	05.2009-09.2011	CDHB		EPBMPN4-D019Z	91102	16,9	116,9
1.8 TFSI	1.798	125	4	10.2007-01.2017	CABD, CJEB		EPBBPT4-V002Z	95912	20	300
1.8 TFSI	1.798	125	4	10.2007-01.2017	CABD, CJEB		EPBMPN4-D019Z	91102	16,9	116,9
1.8 TFSI	1.798	130	4	05.2015-01.2017	CJEE		EPBBPT4-V002Z	95912	20	300
2.0 TDI	1.968	100	4	09.2009-01.2017	CAGE, CJCB, CSUB		EPBBPT4-V002Z	95912	20	300
2.0 TDI	1.968	105	4	09.2009-01.2017	CAGA, CJCA, CMEA, CMFA		EPBBPT4-V002Z	95912	20	300
2.0 TDI	1.968	105	4	09.2009-01.2017	CAGA, CJCA, CMEA, CMFA		EPBMPN4-D019Z	91102	16,9	116,9
2.0 TDI	1.968	110	4	05.2013-01.2017	CJCD, CMFB, CSUA		EPBBPT4-V002Z	95912	20	300
2.0 TDI	1.968	120	4	08.2008-01.2017	CAHB, CGLD, CNHC		EPBBPT4-V002Z	95912	20	300
2.0 TDI, 2.0 TDI quattro	1.968	125	4	08.2008-03.2012	CAHA		EPBBPT4-V002Z	95912	20	300
2.0 TDI, 2.0 TDI quattro	1.968	125	4	08.2008-03.2012	CAHA		EPBMPN4-D019Z	91102	16,9	116,9
2.0 TDI, 2.0 TDI quattro	1.968	130	4	10.2011-01.2017	CGLC		EPBBPT4-V002Z	95912	20	300



MAP



kW

C
Y
I



Type-N°

Stock-N°

kPa from

kPa to

AUDI

A5 (8TA, 8T3, 8F7)

2.0 TFSI	1.984	132	4	11.2008-03.2012	CAEA, CDN B		EPBMPN4-D019Z	91102	16,9	116,9
2.0 TFSI, 2.0 TFSI quattro	1.984	155	4	06.2008-01.2017	CAEB, CDNC, CPMA		EPBMPN4-D019Z	91102	16,9	116,9
2.0 TFSI, 2.0 TFSI quattro	1.984	165	4	05.2013-05.2016	CNCD		EPBBPT4-V002Z	95912	20	300
2.0 TFSI, 2.0 TFSI quattro	1.984	169	4	08.2015-01.2017	CNCE		EPBBPT4-V002Z	95912	20	300
2.7 TDI	2.698	120	6	09.2007-03.2012	CAMB, CGKB		EPBBPT4-V002Z	95912	20	300
2.7 TDI	2.698	120	6	09.2007-03.2012	CAMB, CGKB		EPBMPN4-D019Z	91102	16,9	116,9
2.7 TDI	2.698	140	6	06.2007-03.2012	CAMA, CGKA		EPBBPT4-V002Z	95912	20	300
2.7 TDI	2.698	140	6	06.2007-03.2012	CAMA, CGKA		EPBMPN4-D019Z	91102	16,9	116,9
3.0 TDI	2.967	150	6	10.2011-01.2017	CLAB		EPBBPT4-V002Z	95912	20	300
3.0 TDI quattro	2.967	155	6	03.2008-05.2010	CCWB		EPBBPT4-V002Z	95912	20	300
3.0 TDI quattro	2.967	155	6	03.2008-05.2010	CCWB		EPBMPN4-D019Z	91102	16,9	116,9
3.0 TDI quattro	2.967	160	6	05.2015-01.2017	CKVD		EPBBPT4-V002Z	95912	20	300
3.0 TDI quattro	2.967	176	6	06.2007-03.2012	CAPA, CCWA		EPBBPT4-V002Z	95912	20	300
3.0 TDI quattro	2.967	176	6	06.2007-03.2012	CAPA, CCWA		EPBMPN4-D019Z	91102	16,9	116,9
3.0 TDI quattro	2.967	180	6	10.2011-01.2017	CDUC, CKVB, CKVC		EPBBPT4-V002Z	95912	20	300
3.2 FSI	3.197	195	6	06.2007-03.2012	CALA	; Position: Intake Manifold	EPBMPT4-V008Z	96201	10	117
3.2 FSI	3.197	195	6	06.2007-03.2012	CALA		EPBMPN4-D019Z	91102	16,9	116,9
S5 quattro	2.995	245	6	10.2011-01.2017	CAKA	; ; with charger intercooler	EPBMPT4-V008Z	96201	10	117
S5 quattro	2.995	245	6	10.2011-01.2017	CAKA, CCBA, CGWC, CGXC, CREC, CTDA, CTUB		EPBMPN4-D019Z	91102	16,9	116,9
S5 quattro	4.163	260	8	06.2007-03.2012	CAUA		EPBMPN4-D019Z	91102	16,9	116,9
RS5 quattro	4.163	331	8	03.2010-01.2017	CFSA	; Position: Left	EPBMPT4-V008Z	96201	10	117
RS5 quattro	4.163	331	8	03.2010-01.2017	CFSA		EPBMPN4-D019Z	91102	16,9	116,9

A6 ALLROAD C5 (4BH)

2.5 TDI quattro	2.496	120	6	05.2003-08.2005	BCZ		EPBMPN4-D019Z	91102	16,9	116,9
2.5 TDI quattro	2.496	120	6	05.2003-08.2005	BCZ		EPBBPT4-V019Z	95582	20	250
2.5 TDI quattro	2.496	132	6	05.2000-08.2005	AKE, BAU		EPBMPN4-D019Z	91102	16,9	116,9
2.5 TDI quattro	2.496	132	6	05.2000-08.2005	AKE, BAU		EPBBPT4-V019Z	95582	20	250
2.7 T quattro	2.671	184	6	05.2000-08.2005	ARE, BES		EPBMPN4-D019Z	91102	16,9	116,9
2.7 T quattro	2.671	184	6	05.2000-08.2005	ARE, BES	; Chass.>4B-5-026301	EPBMBT4-D001Z	91628	11	254
4.2 V8 quattro	4.163	220	8	07.2002-08.2005	BAS		EPBMPN4-D019Z	91102	16,9	116,9

A6 ALLROAD C6 (4FH)

2.7 TDI quattro	2.698	120	6	05.2006-08.2011	BSG, CAND		EPBBPT4-V002Z	95912	20	300
2.7 TDI quattro	2.698	120	6	05.2006-08.2011	BSG, CAND		EPBBPT4-V003Z	91742	20	254
2.7 TDI quattro	2.698	120	6	05.2006-08.2011	BSG, CAND		EPBMPN4-D019Z	91102	16,9	116,9
2.7 TDI quattro	2.698	132	6	03.2006-10.2008	BPP		EPBBPT4-V003Z	91742	20	254
2.7 TDI quattro	2.698	132	6	03.2006-10.2008	BPP		EPBMPN4-D019Z	91102	16,9	116,9



MAP

 l kW
C
Y
I

Type-N°

Stock-N°

 kPa from
kPa to

AUDI
A6 ALLROAD C6 (4FH)

2.7 TDI quattro	2.698	140	6	10.2008-08.2011	CANC		EPBBPT4-V002Z	95912	20	300
2.7 TDI quattro	2.698	140	6	10.2008-08.2011	CANC		EPBMPN4-D019Z	91102	16,9	116,9
3.0 TDI quattro	2.967	155	6	-05.2007	BNG, CDYB		EPBMPN4-D019Z	91102	16,9	116,9
3.0 TDI quattro	2.967	155	6	05.2006-08.2011	BNG, CDYB		EPBBPT4-V002Z	95912	20	300
3.0 TDI quattro	2.967	155	6	05.2006-08.2011	BNG, CDYB		EPBBPT4-V003Z	91742	20	254
3.0 TDI quattro	2.967	171	6	05.2006-10.2008	ASB		EPBBPT4-V003Z	91742	20	254
3.0 TDI quattro	2.967	171	6	05.2006-10.2008	ASB		EPBMPN4-D019Z	91102	16,9	116,9
3.0 TDI quattro	2.967	176	6	10.2008-08.2011	CDYA, CDYC		EPBBPT4-V002Z	95912	20	300
3.0 TDI quattro	2.967	176	6	10.2008-08.2011	CDYA, CDYC		EPBMPN4-D019Z	91102	16,9	116,9
3.0 TFSI quattro	2.995	213	6	10.2008-08.2011	CAJA		EPBMPT4-V008Z	96201	10	117
3.0 TFSI quattro	2.995	213	6	10.2008-08.2011	CAJA		EPBMPN4-D019Z	91102	16,9	116,9
3.2 FSI quattro	3.123	188	6	05.2006-10.2008	AUK		EPBMPT4-V008Z	96201	10	117
3.2 FSI quattro	3.123	188	6	05.2006-10.2008	AUK		EPBMPN4-D019Z	91102	16,9	116,9
4.2 FSI quattro	4.163	257	8	05.2006-12.2010	BVJ		EPBMPN4-D019Z	91102	16,9	116,9

A6 ALLROAD C7 (4GH, 4GJ)

3.0 TDI quattro	2.967	150	6	01.2012-12.2014	CLAA		EPBBPT4-V002Z	95912	20	300
3.0 TDI quattro	2.967	180	6	01.2012-06.2016	CDUD, CKVC		EPBBPT4-V002Z	95912	20	300
3.0 TFSI quattro	2.995	228	6	01.2012-12.2014	CGWD	; Before turbocharger	EPBMPT4-V008Z	96201	10	117
3.0 TFSI quattro	2.995	245	6	09.2014-09.2018	CREC	; Before turbocharger	EPBMPT4-V008Z	96201	10	117

A6 C4 (4A2, 4A5)

2.8	2.771	142	6	04.1997-	ACK		EPBMPN4-D019Z	91102	16,9	116,9
-----	-------	-----	---	----------	-----	--	---------------	-------	------	-------

A6 C5 (4B2, 4B5)

1.8 T, 1.8 T quattro	1.781	110	4	05.2000-05.2004	AWT		EPBMPN4-D019Z	91102	16,9	116,9
1.8 T, 1.8 T quattro	1.781	110	4	01.1997-01.2005	ARK, ANB, APU, AWT		EPBMBT4-D001Z	91628	11	254
1.9 TDI	1.896	81	4	04.1997-04.2001	AFN		EPBMBT4-D001Z	91628	11	254
1.9 TDI	1.896	85	4	07.2000-01.2005	AJM		EPBMBT4-D001Z	91628	11	254
1.9 TDI	1.896	96	4	08.2001-01.2005	AVF, AWX		EPBBPT4-V002Z	95912	20	300
1.9 TDI	1.896	96	4	08.2001-01.2005	AVF, AWX		EPBMPN4-D019Z	91102	16,9	116,9
2.4	2.393	100	6	07.1998-01.2005	ALW, ARN, ASM		EPBMPN4-D019Z	91102	16,9	116,9
2.4, 2.4 quattro	2.393	115	6	08.1998-05.2001	APC		EPBMPN4-D019Z	91102	16,9	116,9
2.4, 2.4 quattro	2.393	120	6	02.1997-01.2005	AJG, AMM, APZ		EPBMPN4-D019Z	91102	16,9	116,9
2.4, 2.4 quattro	2.393	121	6	04.1997-09.2001	AGA, ALF, AML, APS, ARJ		EPBMPN4-D019Z	91102	16,9	116,9
2.4, 2.4 quattro	2.393	125	6	08.2001-01.2005	BDV		EPBMPN4-D019Z	91102	16,9	116,9
2.5 TDI, 2.5 TDI quattro	2.496	110	6	07.1997-01.2005	AFB, AKN		EPBBPT4-V019Z	95582	20	250
2.5 TDI	2.496	114	6	08.2001-01.2005	AYM		EPBMPN4-D019Z	91102	16,9	116,9
2.5 TDI	2.496	114	6	08.2001-01.2005	AYM		EPBBPT4-V019Z	95582	20	250
2.5 TDI, 2.5 TDI quattro	2.496	120	6	07.2002-01.2005	BCZ, BDG, BFC		EPBMPN4-D019Z	91102	16,9	116,9



MAP



kW

C
Y
I



Type-N°

Stock-N°

kPa from

kPa to

AUDI

A6 C5 (4B2, 4B5)

2.5 TDI, 2.5 TDI quattro	2.496	120	6	07.2002-01.2005	BCZ, BDG, BFC		EPBBPT4-V019Z	95582	20	250
2.5 TDI, 2.5 TDI quattro	2.496	132	6	02.2000-01.2005	AKE, BAU, BDH		EPBMPN4-D019Z	91102	16,9	116,9
2.5 TDI, 2.5 TDI quattro	2.496	132	6	02.2000-01.2005	AKE, BAU, BDH		EPBBPT4-V019Z	95582	20	250
2.7 T	2.671	169	6	02.1999-05.2001	AJK, AZA		EPBMPN4-D019Z	91102	16,9	116,9
2.7 T quattro	2.671	184	6	08.2001-01.2005	ARE, BES		EPBMPN4-D019Z	91102	16,9	116,9
2.8	2.771	132	6	10.1997-05.2000	AGE		EPBMPN4-D019Z	91102	16,9	116,9
2.8	2.771	140	6	-04.2001	ATX		EPBMPN4-D019Z	91102	16,9	116,9
2.8 quattro	2.771	140	6	07.1999-05.2001	ATX		EPBMPN4-D019Z	91102	16,9	116,9
2.8 quattro	2.771	142	6	04.1997-05.2001	ACK, ALG, AMX, APR		EPBMPN4-D019Z	91102	16,9	116,9
2.8	2.771	142	6	04.1997-04.2001	ACK, ALG, AMX, APR, AQD		EPBMPN4-D019Z	91102	16,9	116,9
2.8 quattro	2.771	142	6	02.1998-05.2001	ACK, ALG, AMX, APR, AQD		EPBMPN4-D019Z	91102	16,9	116,9
3.0 quattro	2.976	160	6	06.2001-07.2004	BBJ		EPBMPN4-D019Z	91102	16,9	116,9
3.0 quattro	2.976	162	6	08.2001-01.2005	ASN		EPBMPN4-D019Z	91102	16,9	116,9
4.2 quattro	4.172	220	8	11.1998-01.2005	ARS, ART, ASG, AWW		EPBMPN4-D019Z	91102	16,9	116,9
S6 quattro	4.172	250	8	09.1999-01.2005	ANK, AQJ, BBD		EPBMPN4-D019Z	91102	16,9	116,9
RS6 quattro	4.172	331	8	07.2002-01.2005	BCY		EPBMBT4-D001Z	91628	11	254
RS6 plus quattro	4.172	353	8	04.2004-01.2005	BRV		EPBMBT4-D001Z	91628	11	254

A6 C6 (4F2, 4F5)

2.0 TDI	1.968	89	4	09.2005-06.2006	BVG		EPBBPT4-V002Z	95912	20	300
2.0 TDI	1.968	100	4	07.2004-03.2011	BNA, BRF, CAGB		EPBBPT4-V002Z	95912	20	300
2.0 TDI	1.968	103	4	07.2004-10.2008	BLB, BRE		EPBBPT4-V002Z	95912	20	300
2.0 TDI	1.968	120	4	04.2009-08.2011	CAHB		EPBBPT4-V002Z	95912	20	300
2.0 TDI	1.968	125	4	10.2008-08.2011	CAHA		EPBBPT4-V002Z	95912	20	300
2.0 TFSI	1.984	125	4	06.2005-08.2011	BPJ, BYK		EPBBPN4-V014Z	93428	20	250
2.4, 2.4 quattro	2.393	130	6	05.2004-10.2008	BDW		EPBMPT4-V008Z	96201	10	117
2.4	2.393	130	6	05.2004-10.2008	BDW		EPBMPN4-D019Z	91102	16,9	116,9
2.7 TDI, 2.7 TDI quattro	2.698	120	6	11.2004-08.2011	BSG, CANB, CAND		EPBBPT4-V002Z	95912	20	300
2.7 TDI, 2.7 TDI quattro	2.698	120	6	11.2004-08.2011	BSG, CANB, CAND		EPBBPT4-V003Z	91742	20	254
2.7 TDI	2.698	132	6	11.2004-10.2008	BPP		EPBBPT4-V003Z	91742	20	254
2.7 TDI	2.698	140	6	10.2008-08.2011	CANA		EPBBPT4-V002Z	95912	20	300
2.7 TDI quattro	2.698	140	6	10.2008-08.2011	CANC		EPBBPT4-V002Z	95912	20	300
2.8 FSI, 2.8 FSI quattro	2.773	140	6	10.2008-08.2011	CCDA		EPBMPT4-V008Z	96201	10	117
2.8 FSI, 2.8 FSI quattro	2.773	154	6	11.2006-10.2008	BDX		EPBMPT4-V008Z	96201	10	117
2.8 FSI	2.773	154	6	11.2006-10.2008	BDX		EPBMPN4-D019Z	91102	16,9	116,9
2.8 FSI, 2.8 FSI quattro	2.773	162	6	10.2008-08.2011	CCEA		EPBMPT4-V008Z	96201	10	117
3.0 TDI quattro	2.967	155	6	05.2004-08.2011	BNG, CDYB		EPBBPT4-V002Z	95912	20	300
3.0 TDI quattro	2.967	155	6	05.2004-08.2011	BNG, CDYB		EPBBPT4-V003Z	91742	20	254



MAP



l kW
C
Y
I



Type-N°

Stock-N°

kPa from
kPa to

AUDI

A6 C6 (4F2, 4F5)

3.0, 3.0 quattro	2.976	160	6	03.2005-05.2006	BBJ		EPBMPN4-D019Z	91102	16,9	116,9
3.0 TDI quattro	2.967	165	6	05.2004-05.2006	BMK		EPBBPT4-V003Z	91742	20	254
3.0 TDI quattro	2.967	171	6	06.2006-10.2008	ASB		EPBBPT4-V003Z	91742	20	254
3.0 TDI quattro	2.967	176	6	10.2008-08.2011	CDYA, CDYC		EPBBPT4-V002Z	95912	20	300
3.0 TFSI quattro	2.995	213	6	10.2008-08.2011	CAJA	; ; Position: Intake Manifold	EPBMPT4-V008Z	96201	10	117
3.0 TFSI quattro	2.995	220	6	10.2008-08.2011	CCAA	; ; Position: Intake Manifold	EPBMPT4-V008Z	96201	10	117
3.2 FSI quattro	3.123	183	6	09.2006-10.2008	BYU		EPBMPT4-V008Z	96201	10	117
3.2 FSI, 3.2 FSI quattro	3.123	188	6	03.2005-10.2008	AUK, BKH		EPBMPN4-D019Z	91102	16,9	116,9
3.2 FSI, 3.2 FSI quattro	3.123	188	6	05.2004-05.2009	AUK, BKH		EPBMPT4-V008Z	96201	10	117
3.2 FSI	3.197	195	6	05.2009-03.2011	CALA		EPBMPT4-V008Z	96201	10	117
4.2 FSI quattro	4.163	257	8	06.2006-08.2011	BVJ		EPBMPN4-D019Z	91102	16,9	116,9
S6 quattro	5.204	320	10	03.2006-08.2011	BXA		EPBMPN4-D019Z	91102	16,9	116,9
RS6 quattro	4.991	426	10	04.2008-08.2010	BUH		EPBBPT4-V003Z	91742	20	254

A6 C7 (4G2, 4GC, 4G5, 4GD)

1.8 TFSI	1.798	140	4	09.2014-09.2018	CYGA		EPBBPT4-V002Z	95912	20	300
2.0 TDI	1.968	100	4	01.2012-09.2018	CGLE, CSUE, DDCA		EPBBPT4-V002Z	95912	20	300
2.0 TDI	1.968	120	4	03.2011-09.2018	CGLD		EPBBPT4-V002Z	95912	20	300
2.0 TDI	1.968	130	4	03.2011-09.2018	CGLC, CMGB		EPBBPT4-V002Z	95912	20	300
2.0 TFSI, 2.0 TFSI quattro	1.984	185	4	05.2014-09.2018	CYNB, CYP A		EPBBPT4-V002Z	95912	20	300
2.8 FSI, 2.8 FSI quattro	2.773	150	6	11.2010-04.2015	CHVA		EPBMPT4-V008Z	96201	10	117
2.8 FSI quattro	2.773	162	6	09.2014-09.2018	CVPA		EPBMPT4-V008Z	96201	10	117
3.0 TDI, 3.0 TDI quattro	2.967	150	6	11.2010-09.2018	CLAB		EPBBPT4-V002Z	95912	20	300
3.0 TDI	2.967	155	6	09.2014-09.2018	CTCB, CZVD		EPBBPT4-V002Z	95912	20	300
3.0 TDI	2.967	160	6	09.2014-09.2018	CTCC, CZVB		EPBBPT4-V002Z	95912	20	300
3.0 TDI quattro	2.967	180	6	03.2011-09.2018	CDUC, CDUD, CKVB, CKVC		EPBBPT4-V002Z	95912	20	300
3.0 TFSI quattro	2.995	220	6	11.2010-05.2012	CGWB	; Before turbocharger	EPBMPT4-V008Z	96201	10	117
3.0 TFSI quattro	2.995	228	6	03.2011-09.2018	CGWD, CGXB, CTUA	; Before turbocharger	EPBMPT4-V008Z	96201	10	117
3.0 TFSI quattro	2.995	245	6	09.2014-09.2018	CREC	; Before turbocharger	EPBMPT4-V008Z	96201	10	117

A7 SPORTBACK (4GA, 4GF)

1.8 TFSI	1.798	140	4	04.2015-05.2018	CYGA		EPBBPT4-V002Z	95912	20	300
2.0 TFSI quattro	1.984	183	4	05.2015-05.2018	CYPB		EPBBPT4-V002Z	95912	20	300
2.0 TFSI, 2.0 TFSI quattro	1.984	185	4	09.2014-05.2018	CYNB, CYP A		EPBBPT4-V002Z	95912	20	300
2.8 FSI, 2.8 FSI quattro	2.773	150	6	10.2010-03.2015	CHVA		EPBMPT4-V008Z	96201	10	117
2.8 FSI quattro	2.773	150	6	10.2010-03.2015	CNYA	; Position: Intake Manifold	EPBMPT4-V008Z	96201	10	117
2.8 FSI quattro	2.773	162	6	09.2014-05.2018	CVPA		EPBMPT4-V008Z	96201	10	117
3.0 TDI	2.967	150	6	11.2010-03.2015	CLAB		EPBBPT4-V002Z	95912	20	300
3.0 TDI quattro	2.967	150	6	12.2010-03.2015	CLAA		EPBBPT4-V002Z	95912	20	300





AUDI

A7 SPORTBACK (4GA, 4GF)

3.0 TDI quattro	2.967	155	6	07.2014-05.2018	CRTF, CTCB, CZVC		EPBBPT4-V002Z	95912	20	300
3.0 TDI	2.967	160	6	07.2014-05.2018	CTCC, CZVB		EPBBPT4-V002Z	95912	20	300
3.0 TDI quattro	2.967	176	6	05.2013-06.2017	CPNB		EPBBPT4-V002Z	95912	20	300
3.0 TDI quattro	2.967	180	6	10.2010-06.2016	CDUC, CDUD, CKVB, CKVC		EPBBPT4-V002Z	95912	20	300
3.0 TFSI quattro	2.995	228	6	01.2011-03.2015	CGXB, CTTA, CGWD	; Before turbocharger	EPBMPT4-V008Z	96201	10	117
3.0 TFSI quattro	2.995	245	6	05.2014-05.2018	CREC	; Before turbocharger	EPBMPT4-V008Z	96201	10	117

A8 D2 (4D2, 4D8)

2.5 TDI, 2.5 TDI quattro	2.496	110	6	01.1997-04.2000	AFB, AKN		EPBBPT4-V019Z	95582	20	250
2.5 TDI, 2.5 TDI quattro	2.496	132	6	09.2000-09.2002	AKE		EPBBPT4-V019Z	95582	20	250
2.8	2.771	142	6	05.2000-	AMX		EPBMPN4-D019Z	91102	16,9	116,9

A8 D3 (4E2, 4E8)

2.8 FSI	2.773	154	6	08.2007-07.2010	BDX		EPBMPT4-V008Z	96201	10	117
3.0 TDI quattro	2.967	155	6	11.2003-07.2010	BNG		EPBBPT4-V003Z	91742	20	254
3.0	2.976	160	6	07.2003-05.2006	BBJ		EPBMPN4-D019Z	91102	16,9	116,9
3.0	2.976	162	6	07.2003-05.2005	ASN		EPBMPN4-D019Z	91102	16,9	116,9
3.0 TDI quattro	2.967	171	6	08.2003-07.2010	ASB		EPBBPT4-V003Z	91742	20	254
3.2 FSI, 3.2 FSI quattro	3.123	191	6	06.2005-07.2010	BPK		EPBMPT4-V008Z	96201	10	117
3.3 TDI quattro	3.328	165	8	06.2000-09.2002	AKF		EPBBPT4-V019Z	95582	20	250
4.0 TDI quattro	3.936	202	8	05.2003-07.2005	ASE		EPBBPT4-V003Z	91742	20	254
4.2 TDI quattro	4.134	235	8	01.2005-06.2005	BMC		EPBBPT4-V002Z	95912	20	300
4.2 TDI quattro	4.134	240	8	07.2005-07.2010	BVN		EPBBPT4-V002Z	95912	20	300
4.2 FSI quattro	4.163	257	8	06.2006-07.2010	BVJ		EPBMPN4-D019Z	91102	16,9	116,9
S8 quattro	5.204	331	10	06.2006-07.2010	BSM		EPBMPN4-D019Z	91102	16,9	116,9

A8 D4 (4H2, 4H8, 4HC, 4HL)

2.5 TFSI	2.498	150	6	07.2012-06.2016	CPAA, CVBA	; Position: Intake Manifold	EPBMPT4-V008Z	96201	10	117
3.0 TDI	2.967	150	6	09.2011-09.2013	CLAB		EPBBPT4-V002Z	95912	20	300
3.0 TDI quattro	2.967	155	6	08.2010-11.2015	CDTB, CTBB		EPBBPT4-V002Z	95912	20	300
3.0 TDI quattro	2.967	176	6	11.2012-06.2016	CPNA, CPNB		EPBBPT4-V002Z	95912	20	300
3.0 TDI quattro	2.967	184	6	07.2010-01.2018	CDTA, CDTC, CMHA	; NTC Sensor	EPBBPT4-V002Z	95912	20	300
3.0 TDI quattro	2.967	190	6	10.2013-01.2018	CTBA		EPBBPT4-V002Z	95912	20	300
3.0 TDI quattro	2.967	193	6	05.2015-01.2018	CTBD		EPBBPT4-V002Z	95912	20	300
3.0 TFSI quattro	2.995	213	6	07.2010-04.2014	CGWA, CREG	; Before turbocharger	EPBMPT4-V008Z	96201	10	117
3.0 TFSI quattro	2.995	228	6	11.2011-01.2018	CGWD, CREA	;	EPBMPT4-V008Z	96201	10	117
3.0 TFSI quattro	2.995	245	6	06.2010-01.2018	CMDA, CGXC	; Before turbocharger	EPBMPT4-V008Z	96201	10	117
3.0 TFSI quattro	2.995	245	6	06.2010-01.2018	CTDA, CTUB, CREC	;	EPBMPT4-V008Z	96201	10	117
4.2 FSI quattro	4.163	273	8	11.2009-12.2012	CDRA		EPBMPT4-V008Z	96201	10	117
4.2 TDI quattro	4.134	258	8	11.2009-04.2014	CDSB		EPBBPT4-V002Z	95912	20	300

MAP



l kW
C
Y
I



Type-N°

Stock-N°

kPa from
kPa to

AUDI

A8 D4 (4H2, 4H8, 4HC, 4HL)

4.2 TDI quattro	4.134	283	8	10.2013-01.2018	CTEC		EPBBPT4-V002Z	95912	20	300
-----------------	-------	-----	---	-----------------	------	--	---------------	-------	----	-----

Q3 (8UB, 8UG)

1.4 TSI	1.395	110	4	10.2013-10.2018	CHPB, CZDA, CZEA		EPBBPT4-V002Z	95912	20	300
2.0 TDI	1.968	100	4	09.2011-10.2018	CFFA, CUVB, DFTB		EPBBPT4-V002Z	95912	20	300
2.0 TDI, 2.0 TDI quattro	1.968	103	4	09.2011-10.2018	CFFB, CLJA		EPBBPT4-V002Z	95912	20	300
2.0 TDI quattro	1.968	120	4	06.2011-04.2015	CFGD		EPBBPT4-V002Z	95912	20	300
2.0 TDI, 2.0 TDI quattro	1.968	130	4	06.2011-10.2018	CFGC, CLLB		EPBBPT4-V002Z	95912	20	300
2.0 TFSI, 2.0 TFSI quattro	1.984	132	4	11.2014-10.2018	CULB		EPBBPT4-V002Z	95912	20	300
RS 2.5 quattro	2.480	228	5	10.2013-10.2018	CTSA		EPBBPT4-V002Z	95912	20	300
RS 2.5 quattro	2.480	228	5	10.2013-10.2018	CTSA	; OE GP1	EPBMPN4-D019Z	91102	16,9	116,9
RS 2.5 quattro	2.480	250	5	05.2013-10.2018	CZGA	; Position: Suction Pipe	EPBBPT4-V002Z	95912	20	300
RS 2.5 quattro	2.480	250	5	05.2013-10.2018	CZGA	; OE GP1	EPBMPN4-D019Z	91102	16,9	116,9
RS performance 2.5 quattro	2.480	270	5	01.2015-10.2018	CZGB	; Position: Suction Pipe	EPBBPT4-V002Z	95912	20	300
RS performance 2.5 quattro	2.480	270	5	01.2015-10.2018	CZGB	; OE GP1	EPBMPN4-D019Z	91102	16,9	116,9

Q5 (8RB)

2.0 TDI, 2.0 TDI quattro	1.968	110	4	05.2013-05.2017	CJCD, CSUA		EPBBPT4-V002Z	95912	20	300
2.0 TDI, 2.0 TDI quattro	1.968	100	4	08.2009-05.2017	CAGB, CJCB, CSUB		EPBBPT4-V002Z	95912	20	300
2.0 TDI, 2.0 TDI quattro	1.968	105	4	08.2009-05.2013	CAGA, CJCA		EPBBPT4-V002Z	95912	20	300
2.0 TDI quattro	1.968	120	4	11.2008-05.2017	CAHB, CGLA, CGLD, CNHC		EPBBPT4-V002Z	95912	20	300
2.0 TDI quattro	1.968	125	4	11.2008-09.2012	CAHA, CGLB, CMGA		EPBBPT4-V002Z	95912	20	300
2.0 TDI quattro	1.968	130	4	06.2012-05.2017	CGLC, CMGB		EPBBPT4-V002Z	95912	20	300
2.0 TFSI quattro	1.984	132	4	08.2009-05.2017	CDNB, CNCB		EPBBPT4-V002Z	95912	20	300
2.0 TFSI quattro	1.984	165	4	06.2012-05.2016	CNCD		EPBBPT4-V002Z	95912	20	300
2.0 TFSI quattro	1.984	169	4	08.2015-05.2017	CNCE		EPBBPT4-V002Z	95912	20	300
3.0 TDI quattro	2.967	155	6	11.2008-09.2012	CCWB		EPBBPT4-V002Z	95912	20	300
3.0 TDI quattro	2.967	176	6	11.2008-05.2017	CCWA, CPNB		EPBBPT4-V002Z	95912	20	300
3.0 TDI quattro	2.967	180	6	06.2012-05.2017	CDUD		EPBBPT4-V002Z	95912	20	300
3.0 TDI quattro	2.967	184	6	06.2012-05.2017	CTBC		EPBBPT4-V002Z	95912	20	300
3.0 TDI quattro	2.967	190	6	11.2013-05.2017	CTBA		EPBBPT4-V002Z	95912	20	300
3.0 TFSI quattro	2.995	200	6	06.2012-05.2017	CTUC, CTVA		EPBMPT4-V008Z	96201	10	117
3.2 FSI quattro	3.197	199	6	11.2008-12.2012	CALB		EPBMPT4-V008Z	96201	10	117
SQ5 TFSI quattro	2.995	260	6	05.2013-05.2017	CTUD, CTXA	; Before turbocharger	EPBMPT4-V008Z	96201	10	117

Q7 (4LB)

3.0 TDI quattro	2.967	150	6	05.2010-08.2015	CJGC, CJMA		EPBBPT4-V002Z	95912	20	300
3.0 TDI quattro	2.967	155	6	-11.2007	BUN		EPBMPN4-D019Z	91102	16,9	116,9
3.0 TDI quattro	2.967	155	6	03.2006-05.2010	BUN, CASB		EPBBPT4-V002Z	95912	20	300
3.0 TDI quattro	2.967	165	6	06.2009-05.2012	CATA		EPBBPT4-V002Z	95912	20	300



MAP



C
K
W
I



Type-N°

Stock-N°

kPa from

kPa to

AUDI

Q7 (4LB)

3.0 TDI quattro	2.967	171	6	03.2006-05.2008	BUG		EPBBPT4-V002Z	95912	20	300
3.0 TDI quattro	2.967	171	6	03.2006-05.2008	BUG		EPBMPN4-D019Z	91102	16,9	116,9
3.0 TDI quattro	2.967	176	6	11.2007-08.2015	CASA, CCMA, CJGA, CNRB		EPBBPT4-V002Z	95912	20	300
3.0 TDI quattro	2.967	180	6	05.2011-08.2015	CJGD, CLZB, CRCA		EPBBPT4-V002Z	95912	20	300
3.0 TFSI quattro	2.995	200	6	05.2010-08.2015	CJTC, CJWC	;	EPBMPT4-V008Z	96201	10	117
3.0 TFSI quattro	2.995	206	6	05.2011-08.2015	CJWE, CTWB	;	EPBMPT4-V008Z	96201	10	117
3.0 TFSI quattro	2.995	245	6	05.2010-08.2015	CJTB, CJWB, CNA, CTWA	; Before turbocharger	EPBMPT4-V008Z	96201	10	117
3.6 FSI quattro	3.597	206	6	08.2006-05.2010	BHK		EPBMPN4-D019Z	91102	16,9	116,9
4.2 TDI quattro	4.134	240	8	03.2007-06.2009	BTR		EPBBPT4-V002Z	95912	20	300
4.2 TDI quattro	4.134	250	8	05.2009-08.2015	CCFA, CCFC		EPBBPT4-V002Z	95912	20	300
4.2 TDI quattro	4.134	250	8	06.2009-05.2010	CCFA		EPBMPN4-D019Z	91102	16,9	116,9
4.2 FSI quattro	4.163	257	8	03.2006-05.2010	BAR		EPBMPN4-D019Z	91102	16,9	116,9
6.0 TDI quattro	5.934	368	12	-04.2012	CCGA		EPBMPN4-D019Z	91102	16,9	116,9
6.0 TDI quattro	5.934	368	12	09.2008-05.2014	CCGA		EPBBPT4-V002Z	95912	20	300

Q7 (4MB, 4MG)

2.0 TFSI quattro	1.984	185	4	08.2015-	CYMC, CYRB		EPBBPT4-V002Z	95912	20	300
3.0 TFSI quattro	2.995	245	6	01.2015-	CREC	; Before turbocharger	EPBMPT4-V008Z	96201	10	117

R8 (422, 423, 427, 429)

4.2 FSI quattro	4.163	309	8	04.2007-09.2010	BYH		EPBMPN4-D019Z	91102	16,9	116,9
4.2 FSI quattro	4.163	316	8	07.2010-07.2015	CNDA		EPBMPN4-D019Z	91102	16,9	116,9
5.2 FSI quattro	5.204	386	10	04.2009-07.2015	BUJ, CTYA		EPBMPN4-D019Z	91102	16,9	116,9
5.2 FSI quattro	5.204	404	10	05.2012-07.2015	CTPA		EPBMPN4-D019Z	91102	16,9	116,9
5.2 FSI quattro	5.204	412	10	11.2010-07.2015	CMPA		EPBMPN4-D019Z	91102	16,9	116,9

TT (8J3, 8J9)

2.0 TDI quattro	1.968	125	4	06.2008-06.2014	CBBB, CFGB		EPBBPT4-V002Z	95912	20	300
2.0 TFSI, 2.0 TFSI quattro	1.984	147	4	08.2006-06.2010	BWA, CCTA	; With Charger Intercooler	EPBBPN4-V014Z	93428	20	250
2.0 TTS quattro	1.984	195	4	05.2008-06.2014	CDLA, CDMA		EPBBPT4-V002Z	95912	20	300
2.0 TTS quattro	1.984	200	4	05.2008-06.2014	CDLB		EPBBPT4-V002Z	95912	20	300
2.5 RS quattro	2.480	250	5	07.2009-06.2014	CEPA		EPBBPT4-V002Z	95912	20	300
2.5 RS quattro	2.480	265	5	05.2011-06.2014	CEPB	; Position: Suction Pipe	EPBBPT4-V002Z	95912	20	300

TT (8N3, 8N9)

1.8 T, 1.8 T quattro	1.781	140	4	09.2005-06.2006	BVR	; Chass.>8N-4-000001	EPBBPN4-V014Z	93428	20	250
1.8 T	1.781	110	4	01.2001-06.2006	AUM	; Chass.<8N-3-050000	EPBMBT4-D001Z	91628	11	254
1.8 T	1.781	110	4	01.2001-06.2006	AUM	; Chass.>8N-4-000001	EPBBPN4-V014Z	93428	20	250
1.8 T	1.781	120	4	09.2005-06.2006	BVP	; Chass.<8N-3-050000	EPBMBT4-D001Z	91628	11	254
1.8 T	1.781	120	4	09.2005-06.2006	BVP	; Chass.>8N-4-000001	EPBBPN4-V014Z	93428	20	250
1.8 T, 1.8 T quattro	1.781	132	4	10.1998-06.2006	ARY, AUQ	; Chass.>8N-4-000001	EPBBPN4-V014Z	93428	20	250



MAP



l kW
C
Y
I



Type-N°

Stock-N°

kPa from
kPa to

AUDI

TT (8N3, 8N9)

1.8 T, 1.8 T quattro	1.781	132	4	10.1998-06.2006	AJQ, APP		EPBMBT4-D001Z	91628	11	254
1.8 T, 1.8 T quattro	1.781	132	4	10.1998-06.2006	AUQ	; Chass.<8N-3-050000	EPBMBT4-D001Z	91628	11	254
1.8 T, 1.8 T quattro	1.781	140	4	09.2005-06.2006	BVR	; Chass.<8N-3-050000	EPBMBT4-D001Z	91628	11	254
1.8 T quattro	1.781	165	4	10.1998-06.2006	BAM	; Chass.>8N-1-031001	EPBBPN4-V014Z	93428	20	250
1.8 T quattro	1.781	165	4	10.1998-06.2006	APX		EPBMBT4-D001Z	91628	11	254
1.8 T quattro	1.781	165	4	10.1998-06.2006	BAM	; Chass.<8N-1-031000	EPBMBT4-D001Z	91628	11	254
1.8 T quattro	1.781	180	4	03.2005-06.2006	BFV		EPBBPN4-V014Z	93428	20	250

TT (FV3, FV9, FVP, FVR)

1.8 TFSI	1.798	132	4	07.2015-08.2018	CJSA, CJSB		EPBBPT4-V002Z	95912	20	300
2.0 TFSI quattro	1.984	162	4	04.2015-	CNTC		EPBBPT4-V002Z	95912	20	300
2.0 TFSI, 2.0 TFSI quattro	1.984	169	4	07.2014-	CHHC		EPBBPT4-V002Z	95912	20	300
2.0 TTS quattro	1.984	210	4	02.2015-	CJXF		EPBBPT4-V002Z	95912	20	300
2.0 TTS quattro	1.984	228	4	11.2014-	CJXG		EPBBPT4-V002Z	95912	20	300

BENTLEY

CONTINENTAL

6.7 Turbo R	6.750	235	8	10.1991-12.2002	L410IT		EPBMPT4-D042Z	91710		
6.75 V8 R	6.750	265	8	10.1991-08.1999	L410IT		EPBMPT4-D042Z	91710		
6.75 V8 S	6.747	286	8	05.1994-12.1995	L410M1T		EPBMPT4-D042Z	91710		
6.75 V8 R	6.747	300	8	08.1999-10.2002	L410M1T2		EPBMPT4-D042Z	91710		
6.75 V8 T Mulliner	6.747	313	8	08.1999-10.2002	L410M1T3		EPBMPT4-D042Z	91710		







CONTINENTAL / CONTINENTAL CONVERTIBLE (3W_, 393, 394)

4.0, 4.0 GT	3.993	373	8	09.2011-	CMMC, CYCB		EPBMPT4-D042Z	91710		
4.0 FLEX, 4.0 FLEX AWD	3.993	373	8	09.2011-	CMMC, CYCB		EPBMPT4-D042Z	91710		
4.0 FLEX, 4.0 FLEX AWD	3.993	388	8	12.2013-	CMMD, CYCA		EPBMPT4-D042Z	91710		
4.0 FLEX	3.993	426	8	10.2014-	DCCA		EPBMPT4-D042Z	91710		
6.0	5.998	412	12	06.2003-12.2011	BEB, BWR, CKHD		EPBMPT4-D042Z	91710		
6.0	5.998	423	12	01.2011-05.2015	CKHB, CVAB		EPBMPT4-D042Z	91710		
6.0 FLEX	5.998	423	12	10.2011-05.2015	CKHB		EPBMPT4-D042Z	91710		
6.0 AWD	5.998	434	12	08.2015-	DBDA		EPBMPT4-D042Z	91710		
6.0 FLEX, 6.0 FLEX AWD	5.998	434	12	-08.2018	DBDA		EPBMPT4-D042Z	91710		
6.0 All-wheel Drive	5.998	448	12	08.2007-04.2011	BWRA, CKHC		EPBMPT4-D042Z	91710		
6.0	5.998	449	12	09.2007-12.2011	BWRA		EPBMPT4-D042Z	91710		
6.0 AWD	5.998	460	12	-05.2014	CVAA		EPBMPT4-D042Z	91710		
6.0 FLEX	5.998	460	12	-05.2014	CVAA		EPBMPT4-D042Z	91710		
6.0	5.998	463	12	10.2009-	BWRB, CKHA		EPBMPT4-D042Z	91710		
6.0 FLEX	5.998	463	12	02.2008-12.2013	BWRB, CKHA		EPBMPT4-D042Z	91710		
6.0	5.998	467	12	07.2015-	CVAC, DBDE		EPBMPT4-D042Z	91710		









BENTLEY

CONTINENTAL / CONTINENTAL CONVERTIBLE (3W_, 393, 394)

6.0 FLEX, 6.0 FLEX AWD	5.998	467	12	07.2015-05.2016	CVAC		EPBMPT4-D042Z	91710		
6.0 CS ISR	5.998	471	12	03.2011-	CKHE, CVAC		EPBMPT4-D042Z	91710		
6.0	5.998	472	12	11.2017-07.2018	DBDD		EPBMPT4-D042Z	91710		
6.0 FLEX AWD	5.998	472	12	05.2016-08.2018	DBDD		EPBMPT4-D042Z	91710		
6.0 AWD	5.998	522	12	11.2017-05.2018	DJLA		EPBMPT4-D042Z	91710		
6.0 Supersports AWD	5.998	522	12	09.2017-05.2018	DJLA		EPBMPT4-D042Z	91710		







CONTINENTAL CONVERTIBLE

6.7	6.747	158	8	07.1984-09.1986	L410A		EPBMPT4-D042Z	91710		
6.7	6.747	160	8	10.1986-09.1989	L410I		EPBMPT4-D042Z	91710		
6.7	6.747	160	8	10.1989-04.1995	L410I		EPBMPT4-D042Z	91710		
6.7 (SCBZD)	6.747	166	8	10.1989-09.1992	L410I		EPBMPT4-D042Z	91710		
6.7 (SCBZD)	6.747	176	8	01.1986-12.1990	L410I		EPBMPT4-D042Z	91710		
6.7	6.747	176	8	01.1991-12.1995	L410I		EPBMPT4-D042Z	91710		

CONTINENTAL COUPE (3S3)











6.0 AWD	5.950	467	12	09.2017-	DDBD		EPBMPT4-D042Z	91710		
---------	-------	-----	----	----------	------	---	---------------	-------	--	--

FLYING SPUR (4W_)

4.0, 4.0 FLEX	3.993	373	8	03.2013-	CMMC, CYCB		EPBMPT4-D042Z	91710		
V8 S 4.0	3.993	388	8	05.2016-	CYCA		EPBMPT4-D042Z	91710		
4.0 FLEX	3.993	388	8	06.2016-	CYCA		EPBMPT4-D042Z	91710		
6.0	5.998	460	12	07.2015-	DBDB		EPBMPT4-D042Z	91710		
6.0	5.998	460	12	-05.2015	CVAA		EPBMPT4-D042Z	91710		
W12 S 6.0	5.998	467	12	11.2016-	DBDE		EPBMPT4-D042Z	91710		

BMW

1 (E81,E82, E87, E88)

116 d	1.995	66	4	01.2011-12.2011	N47D20A	 ; For engines with EGR; Position: Suction Pipe	EPBMBN3-V002Z	94886	27,2	400
116 d	1.995	66	4	01.2011-12.2011	N47D20C		EPBMBN3-V002Z	94886	27,2	400
116 d	1.995	85	4	11.2008-12.2011	N47D20A, N47D20C		EPBMBN3-V002Z	94886	27,2	400
118 d	1.995	90	4	06.2004-02.2007	M47D20(204D4)	 ; Position: Suction Pipe	EPBBPN3-A004Z	97711	50	300
118 d	1.995	100	4	09.2006-10.2013	N47D20A, N47D20C	 ; For engines with EGR; Position: Suction Pipe	EPBMBN3-V002Z	94886	27,2	400
118 d	1.995	105	4	09.2006-10.2013	N47D20A, N47D20C		EPBMBN3-V002Z	94886	27,2	400
120 d	1.995	120	4	06.2004-06.2011	N47D20A		EPBBPN3-A004Z	97711	50	300
120 d	1.995	120	4	03.2007-12.2013	N47D20A		EPBMBN3-V002Z	94886	27,2	400
120 d	1.995	120	4	03.2007-12.2013	N47D20C	 ; For engines with EGR; Position: Suction Pipe	EPBBPN3-A004Z	97711	50	300
120 d	1.995	120	4	09.2007-12.2013	N47D20C	 ; For engines with EGR; Position: Suction Pipe	EPBMBN3-V002Z	94886	27,2	400
120 d	1.995	120	4	06.2004-06.2011	M47D20(204D4)	 ; For engines with EGR; Position: Suction Pipe	EPBBPN3-A004Z	97711	50	300

MAP



l kW
C
Y
I



Type-N°

Stock-N°

kPa from
kPa to

BMW

1 (E81,E82, E87, E88)

120 d	1.995	130	4	03.2007-12.2013	N47D20A, N47D20C		EPBMBN3-V002Z	94886	27,2	400
120 d	1.995	145	4	03.2007-12.2013	N47D20A, N47D20C		EPBMBN3-V002Z	94886	27,2	400
123 d	1.995	150	4	03.2007-12.2013	N47D20B, N47D20D		EPBMBN3-V002Z	94886	27,2	400
135 i	2.979	225	6	10.2007-10.2013	N54B30A, N55B30A		EPBBPT4-V006Z	96941	15	250
M	2.979	250	6	03.2011-06.2012	N54B30A		EPBBPT4-V006Z	96941	15	250

1 (F20, F21)

114 d	1.496	70	3	06.2015-	B37D15A		EPBMBN3-V002Z	94886	27,2	400
114 d	1.598	70	4	07.2012-	N47D16A		EPBMBN3-V002Z	94886	27,2	400
114 i	1.598	75	4	12.2011-	N13B16A		EPBBPN3-V030Z	94092	50	465
116 d	1.496	85	3	03.2015-	B37D15A		EPBMBN3-V002Z	94886	27,2	400
116 d	1.598	85	4	12.2011-	N47D16A		EPBMBN3-V002Z	94886	27,2	400
116 d	1.995	85	4	07.2011-	N47D20C		EPBMBN3-V002Z	94886	27,2	400
116 i	1.598	100	4	07.2011-	N13B16A		EPBBPN3-V030Z	94092	50	465
118 d	1.995	100	4	07.2011-	N47D20C		EPBMBN3-V002Z	94886	27,2	400
118 i	1.598	100	4	03.2015-	N13B16A		EPBBPN3-V030Z	94092	50	465
118 d	1.995	105	4	07.2011-	N47D20C		EPBMBN3-V002Z	94886	27,2	400
118 d, 118 d xDrive	1.995	110	4	03.2015-	B47D20A		EPBMBN3-V002Z	94886	27,2	400
118 i	1.598	125	4	07.2011-	N13B16A		EPBBPN3-V030Z	94092	50	465
120 d	1.995	120	4	07.2011-	B47D20A, N47D20C		EPBMBN3-V002Z	94886	27,2	400
120 i	1.598	130	4	03.2015-	N13B16A		EPBBPN3-V030Z	94092	50	465
120 d	1.995	135	4	07.2011-	N47D20C		EPBMBN3-V002Z	94886	27,2	400
120 d, 120 d xDrive	1.995	140	4	03.2015-	B47D20A		EPBMBN3-V002Z	94886	27,2	400
120 d, 120 d xDrive	1.995	147	4	07.2011-	N47D20C		EPBMBN3-V002Z	94886	27,2	400
125 d	1.995	155	4	12.2011-	B47D20B, N47D20D		EPBMBN3-V002Z	94886	27,2	400
125 d	1.995	160	4	12.2011-	N47D20D		EPBMBN3-V002Z	94886	27,2	400
125 d	1.995	165	4	03.2015-	B47D20B		EPBMBN3-V002Z	94886	27,2	400

1 (F40)

116 d	1.496	85	3	07.2019-	B37C15A		EPBMBN3-V002Z	94886	27,2	400
118 d	1.995	100	4	07.2019-	B47C20B		EPBMBN3-V002Z	94886	27,2	400
118 d	1.995	110	4	07.2019-	B47C20B		EPBMBN3-V002Z	94886	27,2	400
120 d xDrive	1.995	140	4	07.2019-	B47C20B		EPBMBN3-V002Z	94886	27,2	400

2 (F22, F23, F87)

218 d	1.995	100	4	03.2014-	N47D20C, B47D20A		EPBMBN3-V002Z	94886	27,2	400
218 d	1.995	105	4	03.2014-06.2015	N47D20C		EPBMBN3-V002Z	94886	27,2	400
218 d	1.995	110	4	07.2015-	B47D20A		EPBMBN3-V002Z	94886	27,2	400
220 d, 220 d xDrive	1.995	120	4	03.2014-	N47D20C, B47D20A		EPBMBN3-V002Z	94886	27,2	400
220 d	1.995	135	4	10.2012-11.2014	N47D20C		EPBMBN3-V002Z	94886	27,2	400



MAP



kW
C
Y
I



Type-N°

Stock-N°

kPa from

kPa to

BMW

2 (F22, F23, F87)

220 d	1.995	140	4	03.2014-	B47D20A		EPBMBN3-V002Z	94886	27,2	400
220 d	1.995	147	4	10.2012-11.2014	N47D20C		EPBMBN3-V002Z	94886	27,2	400
225 d	1.995	160	4	01.2014-	N47D20D		EPBMBN3-V002Z	94886	27,2	400
225 d	1.995	165	4	07.2015-	B47D20B		EPBMBN3-V002Z	94886	27,2	400

2 ACTIVE TOURER (F45)

214 d	1.496	70	3	07.2014-02.2018	B37C15A		EPBMBN3-V002Z	94886	27,2	400
216 d	1.496	85	3	03.2014-	B37C15A		EPBMBN3-V002Z	94886	27,2	400
218 d, 218 d xDrive	1.995	100	4	11.2013-	B47C20A, B47C20B		EPBMBN3-V002Z	94886	27,2	400
218 d, 218 d xDrive	1.995	110	4	11.2013-	B47C20A, B47C20B		EPBMBN3-V002Z	94886	27,2	400
220 d, 220 d xDrive	1.995	120	4	03.2014-	B47C20A, B47C20B		EPBMBN3-V002Z	94886	27,2	400
220 d, 220 d xDrive	1.995	140	4	03.2014-	B47C20A, B47C20B		EPBMBN3-V002Z	94886	27,2	400

2 GRAN TOURER (F46)

214 d	1.496	70	3	07.2015-02.2018	B37C15A		EPBMBN3-V002Z	94886	27,2	400
216 d	1.496	85	3	08.2014-	B37C15A		EPBMBN3-V002Z	94886	27,2	400
218 d, 218 d xDrive	1.995	100	4	07.2014-	B47C20A, B47C20B		EPBMBN3-V002Z	94886	27,2	400
218 d, 218 d xDrive	1.995	110	4	07.2014-	B47C20A, B47C20B		EPBMBN3-V002Z	94886	27,2	400
220 d, 220 d xDrive	1.995	120	4	09.2014-	B47C20A, B47C20B		EPBMBN3-V002Z	94886	27,2	400
220 d, 220 d xDrive	1.995	140	4	07.2014-	B47C20A, B47C20B		EPBMBN3-V002Z	94886	27,2	400

3 (E46)

318 d	1.951	85	4	09.2001-03.2003	M47D20(204D1)		EPBBPN3-A005Z	90934	30	240
318 d, 318 td	1.995	85	4	03.2003-02.2005	M47D20(204D4)		EPBBPN3-A004Z	97711	50	300
320 d	1.951	95	4	02.1998-08.2001	M47D20(204D1)		EPBBPN3-A005Z	90934	30	240
320 d	1.951	100	4	04.1998-09.2001	M47D20(204D1)		EPBBPN3-A005Z	90934	30	240
320 d	1.951	100	4	04.1998-09.2001	M47D20(204D1)		EPBBPN3-A005Z	90934	30	240
320 td	1.995	100	4	10.2001-12.2002	M47D20(204D4)		EPBBPN3-A004Z	97711	50	300
320 d, 320 td, 320 Cd	1.995	110	4	09.2001-12.2007	M47D20(204D4)		EPBBPN3-A004Z	97711	50	300
330 d	2.926	135	6	10.1999-02.2005	M57D30(306D1)	; Position: Fuel Line	EPBBPN3-A020Z	91829	40	415
330 d, 330 xd	2.926	135	6	10.1999-02.2005	M57D30(306D1)		EPBBPN3-A005Z	90934	30	240
330 d, 330 xd, 330 Cd	2.993	150	6	08.2002-05.2005	M57D30(306D2)		EPBBPN3-A004Z	97711	50	300

3 (E90, E91, E92, E93)

316 d	1.995	85	4	07.2009-06.2012	N47D20C		EPBMBN3-V002Z	94886	27,2	400
318 d	1.995	90	4	03.2005-08.2007	M47D20(204D4)	; Position: Suction Pipe	EPBBPN3-A004Z	97711	50	300
318 d	1.995	100	4	07.2007-06.2012	N47D20A, N47D20C		EPBMBN3-V002Z	94886	27,2	400
318 d	1.995	105	4	02.2007-06.2012	N47D20A, N47D20C		EPBMBN3-V002Z	94886	27,2	400
320 d	1.995	110	4	12.2004-09.2007	M47D20(204D4)	; Position: Suction Pipe	EPBBPN3-A004Z	97711	50	300
320 d	1.995	120	4	12.2004-06.2012	M47D20(204D4)	; Position: Suction Pipe	EPBBPN3-A004Z	97711	50	300
320 d, 320 d xDrive	1.995	120	4	12.2004-12.2013	N47D20A, N47D20C		EPBMBN3-V002Z	94886	27,2	400
320 d, 320 d xDrive	1.995	130	4	02.2007-12.2010	N47D20A, N47D20C		EPBMBN3-V002Z	94886	27,2	400



MAP



l kW
C
Y
I



Type-N°

Stock-N°

kPa from
kPa to

BMW

3 (E90, E91, E92, E93)

320 d, 320 d xDrive	1.995	135	4	03.2010-06.2013	N47D20C		EPBMBN3-V002Z	94886	27,2	400
320 d, 320 d xDrive	1.995	145	4	09.2006-02.2010	N47D20A, N47D20C		EPBMBN3-V002Z	94886	27,2	400
320 d, 320 d xDrive	1.995	147	4	03.2010-10.2013	N47D20C		EPBMBN3-V002Z	94886	27,2	400
325 d	2.993	150	6	09.2009-12.2013	N57D30A		EPBMBN3-V002Z	94886	27,2	400
330 d	2.993	155	6	06.2005-05.2012	N57D30A		EPBMBN3-V002Z	94886	27,2	400
330 d, 330 d xDrive	2.993	180	6	02.2008-12.2013	N57D30A	; Position: Suction Pipe	EPBMBN3-V002Z	94886	27,2	400
335 i, 335 i xDrive	2.979	225	6	06.2006-10.2013	N54B30A, N54B30B, N55B30A		EPBBPT4-V006Z	96941	15	250

3 (F30, F31, F80)

316 d	1.995	85	4	03.2012-06.2019	N47D20C, B47D20A		EPBMBN3-V002Z	94886	27,2	400
316 i	1.598	100	4	03.2013-06.2015	N13B16A		EPBBPN3-V030Z	94092	50	465
318 d	1.995	100	4	03.2012-06.2019	N47D20C, B47D20A		EPBMBN3-V002Z	94886	27,2	400
318 d, 318 d xDrive	1.995	105	4	03.2012-06.2015	N47D20C		EPBMBN3-V002Z	94886	27,2	400
318 d	1.995	110	4	07.2015-06.2019	B47D20A		EPBMBN3-V002Z	94886	27,2	400
320 d, 320 d xDrive	1.995	120	4	11.2011-06.2019	N47D20C, B47D20A		EPBMBN3-V002Z	94886	27,2	400
320 i	1.598	125	4	11.2012-06.2016	N13B16A		EPBBPN3-V030Z	94092	50	465
320 d, 320 d xDrive	1.995	135	4	11.2011-03.2016	N47D20C		EPBMBN3-V002Z	94886	27,2	400
320 d, 320 d xDrive	1.995	140	4	07.2015-06.2019	B47D20A		EPBMBN3-V002Z	94886	27,2	400
320 d, 320 d xDrive	1.995	147	4	11.2011-03.2016	N47D20C		EPBMBN3-V002Z	94886	27,2	400
325 d	1.995	155	4	03.2013-02.2016	N47D20D		EPBMBN3-V002Z	94886	27,2	400
325 d	1.995	160	4	03.2013-02.2016	N47D20D		EPBMBN3-V002Z	94886	27,2	400
325 d	1.995	165	4	03.2016-02.2018	B47D20B		EPBMBN3-V002Z	94886	27,2	400
330 d, 330 d xDrive	2.993	190	6	07.2012-06.2019	N57D30A		EPBMBN3-V002Z	94886	27,2	400
330 d, 330 d xDrive	2.993	210	6	07.2012-06.2019	N57D30A		EPBMBN3-V002Z	94886	27,2	400
335 d xDrive	2.993	230	6	07.2013-06.2019	N57D30B		EPBMBN3-V002Z	94886	27,2	400

3 (G20, G21)

318 d	1.995	100	4	03.2019-	B47D20B		EPBMBN3-V002Z	94886	27,2	400
318 d	1.995	110	4	03.2019-	B47D20B		EPBMBN3-V002Z	94886	27,2	400
320 d, 320 d xDrive	1.995	120	4	11.2018-	B47D20B		EPBMBN3-V002Z	94886	27,2	400
320 d, 320 d xDrive	1.995	140	4	11.2018-	B47D20B		EPBMBN3-V002Z	94886	27,2	400
330 d, 330 d xDrive	2.993	195	6	03.2019-	B57D30A		EPBMBN3-V002Z	94886	27,2	400

3 GRAN TURISMO (F34)

318 d	1.995	100	4	03.2013-	N47D20C		EPBMBN3-V002Z	94886	27,2	400
318 d	1.995	105	4	03.2013-06.2015	N47D20C		EPBMBN3-V002Z	94886	27,2	400
320 d, 320 d xDrive	1.995	120	4	03.2013-	N47D20C, B47D20A		EPBMBN3-V002Z	94886	27,2	400
320 d, 320 d xDrive	1.995	135	4	03.2013-06.2015	N47D20C		EPBMBN3-V002Z	94886	27,2	400
320 d, 320 d xDrive	1.995	147	4	03.2013-06.2015	N47D20C		EPBMBN3-V002Z	94886	27,2	400
325 d	1.995	155	4	07.2013-06.2016	N47D20D		EPBMBN3-V002Z	94886	27,2	400



MAP



kW
C
Y
I



Type-N°

Stock-N°

kPa from

kPa to

BMW

3 GRAN TURISMO (F34)

325 d	1.995	160	4	07.2013-06.2016	N47D20D		EPBMBN3-V002Z	94886	27,2	400
325 d	1.995	165	4	07.2016-02.2018	B47D20B		EPBMBN3-V002Z	94886	27,2	400
330 d, 330 d xDrive	2.993	190	6	03.2014-	N57D30A		EPBMBN3-V002Z	94886	27,2	400
330 d, 330 d xDrive	2.993	210	6	03.2014-	N57D30A		EPBMBN3-V002Z	94886	27,2	400
335 d xDrive	2.993	230	6	03.2014-	N57D30B		EPBMBN3-V002Z	94886	27,2	400

4 (F32, F33, F82, F83)

418 d	1.995	100	4	03.2015-10.2017	B47D20A		EPBMBN3-V002Z	94886	27,2	400
420D, 420 d xDrive	1.995	120	4	07.2013-	N47D20C, B47D20A	; Position: Intake Manifold	EPBMBN3-V002Z	94886	27,2	400
420 d, 420 d xDrive	1.995	135	4	07.2013-06.2015	N47D20C		EPBMBN3-V002Z	94886	27,2	400
420 d	1.995	140	4	07.2015-	B47D20A		EPBMBN3-V002Z	94886	27,2	400
420 d, 420 d xDrive	1.995	147	4	07.2013-06.2015	N47D20C		EPBMBN3-V002Z	94886	27,2	400
425 d	1.995	155	4	03.2014-02.2016	N47D20D		EPBMBN3-V002Z	94886	27,2	400
425 d	1.995	160	4	03.2014-02.2016	N47D20D		EPBMBN3-V002Z	94886	27,2	400
425 d	1.995	165	4	03.2016-02.2018	B47D20B		EPBMBN3-V002Z	94886	27,2	400
430 d, 430 d xDrive	2.993	190	6	03.2014-	N57D30A		EPBMBN3-V002Z	94886	27,2	400
430 d, 430 d xDrive	2.993	210	6	03.2014-	N57D30A		EPBMBN3-V002Z	94886	27,2	400
435 d xDrive	2.993	230	6	11.2013-	N57D30B		EPBMBN3-V002Z	94886	27,2	400

4 GRAN COUPE (F36)

418 d	1.995	100	4	03.2014-	N47D20C, B47D20A		EPBMBN3-V002Z	94886	27,2	400
418 d	1.995	105	4	03.2014-06.2015	N47D20C		EPBMBN3-V002Z	94886	27,2	400
420 d, 420 d xDrive	1.995	120	4	03.2014-	N47D20C, B47D20A		EPBMBN3-V002Z	94886	27,2	400
420 d, 420 d xDrive	1.995	135	4	03.2014-02.2015	N47D20C		EPBMBN3-V002Z	94886	27,2	400
420 d, 420 d xDrive	1.995	147	4	03.2014-02.2015	N47D20C		EPBMBN3-V002Z	94886	27,2	400
425 d	1.995	155	4	03.2016-02.2018	B47D20B		EPBMBN3-V002Z	94886	27,2	400
425 d	1.995	165	4	03.2016-02.2018	B47D20B		EPBMBN3-V002Z	94886	27,2	400
430 d, 430 d xDrive	2.993	190	6	07.2014-	N57D30A		EPBMBN3-V002Z	94886	27,2	400
430 d, 430 d xDrive	2.993	210	6	07.2014-	N57D30A		EPBMBN3-V002Z	94886	27,2	400
435 d xDrive	2.993	230	6	07.2014-	N57D30B		EPBMBN3-V002Z	94886	27,2	400

5 (E39)

520 d	1.951	100	4	02.2000-09.2003	M47D20(204D1)		EPBBPN3-A005Z	90934	30	240
525 tds	2.497	105	6	01.1996-05.2004	M51D25(256T1)		EPBBPN3-A013Z	95023	30	245
525 d	2.497	120	6	02.2000-05.2004	M57D25(256D1)		EPBBPN3-A005Z	90934	30	240
530 d	2.926	135	6	08.1998-09.2000	M57D30(306D1)		EPBBPN3-A005Z	90934	30	240
530 d	2.926	142	6	09.1998-05.2004	M57D30(306D1)		EPBBPN3-A005Z	90934	30	240

5 (E60, E61)

520 d	1.995	110	4	09.2005-02.2007	M47D20(204D4)		EPBBPN3-A004Z	97711	50	300
520 d	1.995	120	4	04.2005-05.2010	M47D20(204D4)		EPBBPN3-A004Z	97711	50	300
520 d	1.995	120	4	04.2005-05.2010	N47D20C		EPBMBN3-V002Z	94886	27,2	400



MAP



l kW
C
Y
I



Type-N°

Stock-N°

kPa from
kPa to

BMW

5 (E60, E61)

520 d	1.995	130	4	09.2007-05.2010	N47D20A, N47D20C		EPBMBN3-V002Z	94886	27,2	400
530 d	2.993	155	6	09.2002-12.2009	M57D30(306D2)	; Position: Intake Manifold	EPBBPN3-A004Z	97711	50	300
530 d	2.993	160	6	09.2002-09.2005	M57D30(306D2)	; Position: Intake Manifold	EPBBPN3-A004Z	97711	50	300

5 (F10, F11)

518 d	1.995	100	4	07.2013-02.2017	N47D20C		EPBMBN3-V002Z	94886	27,2	400
518 d	1.995	100	4	07.2013-02.2017	B47D20A	; Position: Intake Manifold	EPBMBN3-V002Z	94886	27,2	400
518 d	1.995	105	4	07.2013-06.2014	N47D20C		EPBMBN3-V002Z	94886	27,2	400
518 d	1.995	110	4	07.2014-02.2017	B47D20A		EPBMBN3-V002Z	94886	27,2	400
518 d	1.995	120	4	10.2013-02.2017	B47D20A		EPBMBN3-V002Z	94886	27,2	400
520 d, 520 d xDrive	1.995	100	4	06.2010-06.2014	N47D20C		EPBMBN3-V002Z	94886	27,2	400
520 d, 520 d xDrive	1.995	120	4	06.2010-02.2017	N47D20C, B47D20A		EPBMBN3-V002Z	94886	27,2	400
520 d, 520 d xDrive	1.995	135	4	06.2010-06.2014	N47D20C		EPBMBN3-V002Z	94886	27,2	400
520 d, 520 d xDrive	1.995	140	4	07.2014-02.2017	B47D20A		EPBMBN3-V002Z	94886	27,2	400
520 d, 520 d xDrive	1.995	147	4	06.2010-06.2014	N47D20C		EPBMBN3-V002Z	94886	27,2	400
520 d, 520 d xDrive	1.995	151	4	07.2014-02.2017	B47D20A		EPBMBN3-V002Z	94886	27,2	400
520 d, 520 d xDrive	1.995	155	4	10.2013-02.2017	B47D20A		EPBMBN3-V002Z	94886	27,2	400
525 d	2.993	150	6	03.2010-08.2011	N57D30A		EPBMBN3-V002Z	94886	27,2	400
525 d, 525 d xDrive	1.995	155	4	09.2011-02.2017	N47D20D		EPBMBN3-V002Z	94886	27,2	400
525 d, 525 d xDrive	1.995	160	4	09.2011-02.2017	N47D20D		EPBMBN3-V002Z	94886	27,2	400
530 d	2.993	180	6	01.2010-08.2011	N57D30A		EPBMBN3-V002Z	94886	27,2	400
530 d, 530 d xDrive	2.993	190	6	03.2011-02.2017	N57D30A		EPBMBN3-V002Z	94886	27,2	400
530 d, 530 d xDrive	2.993	210	6	03.2011-02.2017	N57D30A		EPBMBN3-V002Z	94886	27,2	400
535 d	2.993	220	6	09.2010-08.2011	N57D30B		EPBMBN3-V002Z	94886	27,2	400
535 d, 535 d xDrive	2.993	230	6	09.2011-02.2017	N57D30B		EPBMBN3-V002Z	94886	27,2	400
535 i	2.979	225	6	01.2010-02.2017	N55B30A		EPBBPT4-V006Z	96941	15	250
550 i, 550 i xDrive	4.395	300	8	03.2010-06.2013	N63B44A		EPBBPT4-V006Z	96941	15	250

5 (G30, G31, F90)

518 d	1.995	100	4	07.2018-	B47D20B		EPBMBN3-V002Z	94886	27,2	400
518 d	1.995	110	4	07.2018-	B47D20B		EPBMBN3-V002Z	94886	27,2	400
520 d, 520 d xDrive	1.995	120	4	09.2016-	B47D20A, B47D20B		EPBMBN3-V002Z	94886	27,2	400
520 d, 520 d xDrive	1.995	140	4	09.2016-	B47D20A, B47D20B		EPBMBN3-V002Z	94886	27,2	400
525 d	1.995	155	4	07.2017-	B47D20B		EPBMBN3-V002Z	94886	27,2	400
525 d	1.995	170	4	07.2017-	B47D20B		EPBMBN3-V002Z	94886	27,2	400
530 d xDrive	2.993	183	6	09.2016-	B57D30A		EPBMBN3-V002Z	94886	27,2	400
530 d, 530 d xDrive	2.993	195	6	09.2016-	B57D30A		EPBMBN3-V002Z	94886	27,2	400
540 d xDrive	2.993	235	6	07.2017-	B57D30B		EPBMBN3-V002Z	94886	27,2	400



MAP



l kW
C
Y
I



Type-N°

Stock-N°

kPa from

kPa to

BMW

5 GRAN TURISMO (F07)

520 d	1.995	100	4	07.2013-02.2017	N47D20C		EPBMBN3-V002Z	94886	27,2	400
520 d	1.995	120	4	07.2012-06.2013	N47D20C		EPBMBN3-V002Z	94886	27,2	400
520 d	1.995	135	4	04.2011-02.2017	N47D20C		EPBMBN3-V002Z	94886	27,2	400
530 d	2.993	155	6	09.2010-02.2017	N57D30A		EPBMBN3-V002Z	94886	27,2	400
530 d, 530 d xDrive	2.993	180	6	08.2009-06.2012	N57D30A		EPBMBN3-V002Z	94886	27,2	400
530 d, 530 d xDrive	2.993	190	6	07.2012-02.2017	N57D30A		EPBMBN3-V002Z	94886	27,2	400
535 d, 535 d xDrive	2.993	220	6	03.2010-06.2012	N57D30B		EPBMBN3-V002Z	94886	27,2	400
535 d, 535 d xDrive	2.993	230	6	07.2012-02.2017	N57D30B		EPBMBN3-V002Z	94886	27,2	400
535 i xDrive	2.979	225	6	09.2010-02.2017	N55B30A		EPBBPT4-V006Z	96941	15	250
550 i, 550 i xDrive	4.395	300	8	08.2009-06.2012	N63B44A		EPBBPT4-V006Z	96941	15	250

6 (F12, F13)

640 d, 640 d xDrive	2.993	230	6	09.2011-06.2018	N57D30B		EPBMBN3-V002Z	94886	27,2	400
640 i	2.979	235	6	09.2011-06.2018	N55B30A		EPBBPT4-V006Z	96941	15	250
650 i, 650 i xDrive	4.395	300	8	12.2010-06.2012	N63B44A		EPBBPT4-V006Z	96941	15	250
650 i xDrive	4.395	330	8	07.2012-06.2018	N63B44A, N63B44B		EPBBPT4-V006Z	96941	15	250

6 GRAN COUPE (F06)

640 d, 640 d xDrive	2.993	230	6	03.2012-10.2018	N57D30B		EPBMBN3-V002Z	94886	27,2	400
---------------------	-------	-----	---	-----------------	---------	--	---------------	-------	------	-----

6 GRAN TURISMO (G32)

620 d, 620 d xDrive	1.995	120	4	07.2018-	B47D20B		EPBMBN3-V002Z	94886	27,2	400
620 d, 620 d xDrive	1.995	140	4	07.2018-	B47D20B		EPBMBN3-V002Z	94886	27,2	400
630 d, 630 d xDrive	2.993	155	6	06.2017-	B57D30A		EPBMBN3-V002Z	94886	27,2	400
630 d xDrive	2.993	183	6	06.2017-	B57D30A		EPBMBN3-V002Z	94886	27,2	400
630 d, 630 d xDrive	2.993	195	6	06.2017-	B57D30A		EPBMBN3-V002Z	94886	27,2	400
640 d xDrive	2.993	235	6	11.2017-	B57D30B		EPBMBN3-V002Z	94886	27,2	400

7 (E38)

725 tds	2.497	105	6	04.1996-11.2001	M51D25(256T1)		EPBBPN3-A013Z	95023	30	245
730 d	2.926	135	6	08.1998-04.2000	M57D30(306D1)		EPBBPN3-A005Z	90934	30	240
730 d	2.926	142	6	04.2000-11.2001	M57D30(306D1)		EPBBPN3-A005Z	90934	30	240
740 d	3.901	180	8	05.1999-11.2001	M67D39(398D1)		EPBBPN3-A005Z	90934	30	240

7 (E65, E66, E67)

730 d	2.993	150	6	09.2002-08.2003	M57D30(306D2)		EPBBPN3-A004Z	97711	50	300
730 d	2.993	160	6	06.2002-02.2005	M57D30(306D2)		EPBBPN3-A004Z	97711	50	300
740 d	3.901	190	8	10.2002-02.2005	M67D39(398D1)		EPBBPN3-A004Z	97711	50	300

7 (F01, F02, F03, F04)

730 d, 730 d xDrive	2.993	155	6	02.2008-05.2015	N57D30A		EPBMBN3-V002Z	94886	27,2	400
730 d	2.993	180	6	09.2008-06.2012	N57D30A		EPBMBN3-V002Z	94886	27,2	400
730 d, 730 d xDrive	2.993	190	6	11.2011-05.2015	N57D30A		EPBMBN3-V002Z	94886	27,2	400
740 d	2.993	225	6	09.2009-06.2012	N57D30B		EPBMBN3-V002Z	94886	27,2	400



MAP



ℓ kW C Y I



Type-N°

Stock-N°

kPa from
kPa to

BMW

7 (F01, F02, F03, F04)

740 d, 740 d xDrive	2.993	230	6	07.2012-06.2015	N57D30B		EPBMBN3-V002Z	94886	27,2	400
740 i, Li	2.979	240	6	09.2008-06.2012	N54B30A		EPBBPT4-V006Z	96941	15	250
750 i, Li	4.395	300	8	09.2008-06.2012	N63B44A		EPBBPT4-V006Z	96941	15	250
750 i, Li xDrive	4.395	300	8	09.2009-06.2012	N63B44A, N63B44B		EPBBPT4-V006Z	96941	15	250
ActiveHybrid 7	4.395	330	8	04.2010-06.2012	N63B44A		EPBBPT4-V006Z	96941	15	250
ActiveHybrid 7	4.395	342	8	04.2010-06.2012	N63B44A		EPBBPT4-V006Z	96941	15	250
760 i, Li	5.972	400	12	09.2009-12.2015	N74B60A		EPBBPT4-V006Z	96941	15	250

7 (G11, G12)

725 d, Ld	1.995	155	4	07.2016-02.2019	B47D20B		EPBMBN3-V002Z	94886	27,2	400
725 d, Ld	1.995	170	4	07.2016-02.2019	B47D20B		EPBMBN3-V002Z	94886	27,2	400
730 d, 730 d xDrive	2.993	155	6	07.2015-	B57D30A		EPBMBN3-V002Z	94886	27,2	400
730 d, Ld xDrive	2.993	183	6	09.2015-	B57D30A		EPBMBN3-V002Z	94886	27,2	400
730 d	2.993	195	6	09.2015-	B57D30A		EPBMBN3-V002Z	94886	27,2	400
730 d, Ld xDrive	2.993	195	6	09.2015-	B57D30A		EPBMBN3-V002Z	94886	27,2	400
740 d, Ld xDrive	2.993	235	6	11.2015-	B57D30B		EPBMBN3-V002Z	94886	27,2	400

8 (G14, G15, F91, F92)

840 d xDrive	2.993	235	6	07.2018-	B57D30B		EPBMBN3-V002Z	94886	27,2	400
--------------	-------	-----	---	----------	---------	--	---------------	-------	------	-----

8 GRAN COUPE (G16, F93)

840 d xDrive	2.993	235	6	07.2019-	B57D30B		EPBMBN3-V002Z	94886	27,2	400
--------------	-------	-----	---	----------	---------	--	---------------	-------	------	-----

X1 (E84)

sDrive 16 d	1.995	85	4	04.2012-06.2015	N47D20C		EPBMBN3-V002Z	94886	27,2	400
sDrive 18 d	1.995	100	4	03.2009-06.2015	N47D20C		EPBMBN3-V002Z	94886	27,2	400
xDrive 18 d	1.995	100	4	03.2009-06.2015	N47D20C		EPBMBN3-V002Z	94886	27,2	400
sDrive 18 d	1.995	105	4	12.2009-06.2015	N47D20C		EPBMBN3-V002Z	94886	27,2	400
xDrive 18 d	1.995	105	4	10.2009-06.2015	N47D20C		EPBMBN3-V002Z	94886	27,2	400
sDrive 20 d	1.995	120	4	03.2010-06.2015	N47D20C		EPBMBN3-V002Z	94886	27,2	400
xDrive 20 d	1.995	120	4	03.2010-06.2015	N47D20C		EPBMBN3-V002Z	94886	27,2	400
sDrive 20 d	1.995	130	4	10.2009-06.2015	N47D20C		EPBMBN3-V002Z	94886	27,2	400
xDrive 20 d	1.995	130	4	09.2009-06.2012	N47D20C		EPBMBN3-V002Z	94886	27,2	400
sDrive 20 d	1.995	135	4	07.2012-06.2015	N47D20C		EPBMBN3-V002Z	94886	27,2	400
xDrive 20 d	1.995	135	4	07.2012-06.2015	N47D20C		EPBMBN3-V002Z	94886	27,2	400
xDrive 23 d	1.995	150	4	10.2009-06.2015	N47D20D		EPBMBN3-V002Z	94886	27,2	400
xDrive 25 d	1.995	160	4	10.2009-06.2015	N47D20D		EPBMBN3-V002Z	94886	27,2	400

X1 (F48)

sDrive 16 d	1.496	85	3	11.2014-	B37C15A		EPBMBN3-V002Z	94886	27,2	400
sDrive 18 d	1.995	100	4	07.2015-	B47C20A		EPBMBN3-V002Z	94886	27,2	400
xDrive 18 d	1.995	100	4	11.2014-	B47C20A		EPBMBN3-V002Z	94886	27,2	400
sDrive 18 d	1.995	110	4	07.2015-	B47C20A, B47C20B		EPBMBN3-V002Z	94886	27,2	400





BMW

X1 (F48)

xDrive 18 d	1.995	110	4	11.2014-	B47C20A, B47C20B		EPBMBN3-V002Z	94886	27,2	400
xDrive 20 d	1.995	120	4	07.2015-	B47C20A, B47C20B		EPBMBN3-V002Z	94886	27,2	400
sDrive 20 d	1.995	120	4	11.2015-	B47C20A, B47C20B		EPBMBN3-V002Z	94886	27,2	400
xDrive 20 d	1.995	140	4	07.2015-	B47C20A, B47C20B		EPBMBN3-V002Z	94886	27,2	400
sDrive 20 d	1.995	140	4	11.2015-	B47C20A, B47C20B		EPBMBN3-V002Z	94886	27,2	400
xDrive 25 d	1.995	170	4	11.2014-	B47C20B		EPBMBN3-V002Z	94886	27,2	400

X2 (F39)

sDrive 16 d	1.496	85	3	11.2018-	B37C15A		EPBMBN3-V002Z	94886	27,2	400
xDrive 18 d	1.995	100	4	03.2018-	B47C20B		EPBMBN3-V002Z	94886	27,2	400
sDrive 18 d	1.995	100	4	03.2018-	B47C20A, B47C20B		EPBMBN3-V002Z	94886	27,2	400
xDrive 18 d	1.995	110	4	03.2018-	B47C20B		EPBMBN3-V002Z	94886	27,2	400
sDrive 18 d	1.995	110	4	03.2018-	B47C20A, B47C20B		EPBMBN3-V002Z	94886	27,2	400
xDrive 20 d	1.995	120	4	11.2017-	B47C20A		EPBMBN3-V002Z	94886	27,2	400
sDrive 20 d	1.995	120	4	11.2018-	B47C20A, B47C20B		EPBMBN3-V002Z	94886	27,2	400
xDrive 20 d	1.995	140	4	11.2017-	B47C20A		EPBMBN3-V002Z	94886	27,2	400
sDrive 20 d	1.995	140	4	11.2018-	B47C20A, B47C20B		EPBMBN3-V002Z	94886	27,2	400
xDrive 25 d	1.995	170	4	11.2017-	B47C20B		EPBMBN3-V002Z	94886	27,2	400

X3 (E83)

xDrive 18 d	1.995	100	4	04.2009-12.2011	N47D20C		EPBMBN3-V002Z	94886	27,2	400
xDrive 18 d	1.995	105	4	09.2008-12.2011	N47D20C		EPBMBN3-V002Z	94886	27,2	400
2.0 d	1.995	110	4	09.2004-08.2007	M47D20(204D4)	; Position: Suction Pipe	EPBPN3-A004Z	97711	50	300
xDrive 20 d	1.995	120	4	09.2008-08.2010	N47D20C		EPBMBN3-V002Z	94886	27,2	400
xDrive 20 d	1.995	130	4	09.2008-08.2010	N47D20C		EPBMBN3-V002Z	94886	27,2	400
2.0 d	1.995	130	4	09.2007-08.2008	N47D20A		EPBMBN3-V002Z	94886	27,2	400
2.0 d	1.995	130	4	09.2007-08.2008	N47D20C	; Position: Suction Pipe	EPBMBN3-V002Z	94886	27,2	400

X3 (F25)

sDrive 18 d	1.995	100	4	10.2012-03.2014	N47D20C		EPBMBN3-V002Z	94886	27,2	400
sDrive 18 d	1.995	105	4	10.2012-03.2014	N47D20C		EPBMBN3-V002Z	94886	27,2	400
sDrive 18 d	1.995	110	4	04.2014-08.2017	B47D20A		EPBMBN3-V002Z	94886	27,2	400
xDrive 20 d	1.995	120	4	09.2010-03.2014	N47D20C		EPBMBN3-V002Z	94886	27,2	400
xDrive 20 d	1.995	135	4	09.2010-03.2014	N47D20C		EPBMBN3-V002Z	94886	27,2	400
xDrive 20 d	1.995	140	4	04.2014-08.2017	B47D20A		EPBMBN3-V002Z	94886	27,2	400
xDrive 30 d	2.993	155	6	04.2011-08.2017	N57D30A		EPBMBN3-V002Z	94886	27,2	400
xDrive 30 d	2.993	183	6	06.2011-08.2017	N57D30A		EPBMBN3-V002Z	94886	27,2	400
xDrive 30 d	2.993	190	6	04.2011-08.2017	N57D30A		EPBMBN3-V002Z	94886	27,2	400
xDrive 30 d	2.993	204	6	06.2016-08.2017	N57D30A		EPBMBN3-V002Z	94886	27,2	400
xDrive 30 d	2.993	210	6	04.2011-05.2016	N57D30A		EPBMBN3-V002Z	94886	27,2	400

MAP



l kW
C
Y
I



Type-N°

Stock-N°

kPa from
kPa to

BMW

X3 (F25)

xDrive 35 i	2.979	225	6	09.2010-08.2017	N55B30A		EPBBPT4-V006Z	96941	15	250
xDrive 35 d	2.993	230	6	10.2011-08.2017	N57D30B		EPBMBN3-V002Z	94886	27,2	400

X3 (G01, F97)

sDrive 18 d	1.995	100	4	04.2018-	B47D20A, B47D20B		EPBMBN3-V002Z	94886	27,2	400
sDrive 18 d	1.995	110	4	04.2018-	B47D20A, B47D20B		EPBMBN3-V002Z	94886	27,2	400
xDrive 20 d	1.995	120	4	08.2017-	B47D20A, B47D20B		EPBMBN3-V002Z	94886	27,2	400
xDrive 20 d	1.995	140	4	08.2017-	B47D20A, B47D20B		EPBMBN3-V002Z	94886	27,2	400
xDrive 25 d	1.995	155	4	04.2018-	B47D20B		EPBMBN3-V002Z	94886	27,2	400
xDrive 25 d	1.995	170	4	04.2018-	B47D20B		EPBMBN3-V002Z	94886	27,2	400
xDrive 30d	2.993	183	6	12.2017-	B57D30A		EPBMBN3-V002Z	94886	27,2	400
xDrive 30d	2.993	195	6	08.2017-	B57D30A		EPBMBN3-V002Z	94886	27,2	400
xDrive M40 d	2.993	240	6	08.2018-	B57D30B		EPBMBN3-V002Z	94886	27,2	400

X4 (F26)

xDrive 20 d	1.995	120	4	04.2014-03.2018	B47D20A		EPBMBN3-V002Z	94886	27,2	400
xDrive 20 d	1.995	140	4	04.2014-03.2018	B47D20A		EPBMBN3-V002Z	94886	27,2	400
xDrive 30 d	2.993	155	6	04.2014-03.2018	N57D30A		EPBMBN3-V002Z	94886	27,2	400
xDrive 30 d	2.993	183	6	04.2015-03.2018	N57D30A		EPBMBN3-V002Z	94886	27,2	400
xDrive 30 d	2.993	190	6	04.2014-03.2018	N57D30A		EPBMBN3-V002Z	94886	27,2	400
xDrive 30 d	2.993	204	6	04.2014-03.2018	N57D30A		EPBMBN3-V002Z	94886	27,2	400
xDrive 30 d	2.993	210	6	04.2014-03.2018	N57D30A		EPBMBN3-V002Z	94886	27,2	400
xDrive 35 d	2.993	230	6	04.2014-03.2018	N57D30B		EPBMBN3-V002Z	94886	27,2	400

X4 (G02, F98)

xDrive 20 d	1.995	120	4	04.2018-	B47D20A		EPBMBN3-V002Z	94886	27,2	400
xDrive 20 d	1.995	140	4	04.2018-	B47D20A		EPBMBN3-V002Z	94886	27,2	400
xDrive 25 d	1.995	155	4	04.2018-	B47D20B		EPBMBN3-V002Z	94886	27,2	400
xDrive 25 d	1.995	170	4	04.2018-	B47D20B		EPBMBN3-V002Z	94886	27,2	400
xDrive 30 d	2.993	183	6	09.2018-	B57D30A		EPBMBN3-V002Z	94886	27,2	400
xDrive 30 d	2.993	195	6	04.2018-	B57D30A		EPBMBN3-V002Z	94886	27,2	400
M40 d xDrive	2.993	240	6	04.2018-	B57D30B		EPBMBN3-V002Z	94886	27,2	400

X5 (E53)

3.0 d	2.925	135	6	04.2001-09.2003	M57D30(306D1)	; Position: Fuel Line	EPBBPN3-A020Z	91829	40	415
3.0 d	2.925	135	6	04.2001-09.2003	M57D30(306D1)		EPBBPN3-A005Z	90934	30	240
3.0 d	2.993	155	6	10.2003-09.2006	M57D30(306D2)	; For engines with EGR	EPBBPN3-A004Z	97711	50	300
3.0 d	2.993	160	6	10.2003-09.2006	M57D30(306D2)	; For engines with EGR	EPBBPN3-A004Z	97711	50	300

X5 (E70)

xDrive 30 d	2.993	155	6	10.2008-07.2013	N57D30A		EPBMBN3-V002Z	94886	27,2	400
xDrive 30 d	2.993	180	6	04.2010-07.2013	N57D30A		EPBMBN3-V002Z	94886	27,2	400
xDrive 35 i	2.979	225	6	04.2010-07.2013	N55B30A		EPBBPT4-V006Z	96941	15	250



MAP



l kW
C
Y
I



Type-N°

Stock-N°

kPa from

kPa to

BMW

X5 (E70)

xDrive 40 d	2.993	225	6	09.2010-06.2013	N57D30B		EPBMBN3-V002Z	94886	27,2	400
xDrive 50 i	4.395	300	8	04.2010-07.2013	N63B44A		EPBBPT4-V006Z	96941	15	250

X5 (F15, F85)

sDrive 25 d	1.995	155	4	12.2013-07.2015	N47D20D		EPBMBN3-V002Z	94886	27,2	400
xDrive 25 d	1.995	155	4	12.2013-07.2015	N47D20D		EPBMBN3-V002Z	94886	27,2	400
sDrive 25 d	1.995	160	4	12.2013-07.2015	N47D20D		EPBMBN3-V002Z	94886	27,2	400
xDrive 25 d	1.995	160	4	12.2013-07.2015	N47D20D		EPBMBN3-V002Z	94886	27,2	400
xDrive 25 d	2.993	160	6	04.2014-07.2018	N57D30A		EPBMBN3-V002Z	94886	27,2	400
sDrive 25 d	1.995	170	4	08.2015-07.2018	B47D20B		EPBMBN3-V002Z	94886	27,2	400
xDrive 25 d	1.995	170	4	08.2015-07.2018	B47D20B		EPBMBN3-V002Z	94886	27,2	400
xDrive 30 d	2.993	183	6	12.2013-07.2018	N57D30A		EPBMBN3-V002Z	94886	27,2	400
xDrive 30 d	2.993	190	6	08.2013-07.2018	N57D30A		EPBMBN3-V002Z	94886	27,2	400
xDrive 30 d	2.993	204	6	08.2013-07.2018	N57D30A		EPBMBN3-V002Z	94886	27,2	400
xDrive 30 d	2.993	210	6	08.2013-07.2018	N57D30A		EPBMBN3-V002Z	94886	27,2	400
xDrive 40 d	2.993	230	6	12.2013-07.2018	N57D30B		EPBMBN3-V002Z	94886	27,2	400

X5 (G05, F95)

xDrive 25 d	1.995	155	4	08.2019-	B47D20B		EPBMBN3-V002Z	94886	27,2	400
xDrive 25 d	1.995	170	4	08.2019-	B47D20B		EPBMBN3-V002Z	94886	27,2	400
xDrive 30 d	2.993	183	6	08.2018-	B57D30A		EPBMBN3-V002Z	94886	27,2	400
xDrive 30 d	2.993	195	6	08.2018-	B57D30A		EPBMBN3-V002Z	94886	27,2	400

X6 (E71, E72)

xDrive 30 d	2.993	155	6	04.2010-07.2014	N57D30A		EPBMBN3-V002Z	94886	27,2	400
xDrive 30 d	2.993	173	6	04.2008-03.2010	M57D30(306D3)	; Position: Intake Manifold	EPBMBN3-V002Z	94886	27,2	400
xDrive 30 d	2.993	180	6	04.2010-07.2014	N57D30A		EPBMBN3-V002Z	94886	27,2	400
xDrive 35 i	2.979	225	6	01.2008-07.2014	N54B30A, N55B30A		EPBBPT4-V006Z	96941	15	250
xDrive 40 d	2.993	225	6	07.2009-06.2014	N57D30B		EPBMBN3-V002Z	94886	27,2	400
xDrive 50 i	4.395	300	8	07.2008-07.2014	N63B44A		EPBBPT4-V006Z	96941	15	250
ActiveHybrid	4.395	357	8	01.2009-10.2011	N63B44A		EPBBPT4-V006Z	96941	15	250

X6 (F16, F86)

xDrive 30 d	2.993	155	6	08.2014-07.2019	N57D30A		EPBMBN3-V002Z	94886	27,2	400
xDrive 30 d	2.993	183	6	12.2014-07.2019	N57D30A		EPBMBN3-V002Z	94886	27,2	400
xDrive 30 d	2.993	190	6	08.2014-07.2019	N57D30A		EPBMBN3-V002Z	94886	27,2	400
xDrive 30 d	2.993	204	6	08.2014-07.2019	N57D30A		EPBMBN3-V002Z	94886	27,2	400
xDrive 40 d	2.993	230	6	12.2014-07.2019	N57D30B	; Position: Intake Manifold	EPBMBN3-V002Z	94886	27,2	400

X6 (G06, F96)

xDrive 30 d	2.993	155	6	08.2019-	B57D30A		EPBMBN3-V002Z	94886	27,2	400
xDrive 30 d	2.993	183	6	08.2019-	B57D30A		EPBMBN3-V002Z	94886	27,2	400
xDrive 30 d	2.993	195	6	08.2019-	B57D30A		EPBMBN3-V002Z	94886	27,2	400



MAP



l kW
C
Y
I



Type-Nº

Stock-Nº

kPa from
kPa to

BMW

X7 (G07)

xDrive 30 d	2.993	155	6	03.2019-	B57D30A		EPBMBN3-V002Z	94886	27,2	400
xDrive 30 d	2.993	183	6	03.2019-	B57D30A		EPBMBN3-V002Z	94886	27,2	400
xDrive 30 d	2.993	195	6	03.2019-	B57D30A		EPBMBN3-V002Z	94886	27,2	400

Z4 (E89)

sDrive 35 i	2.979	225	6	02.2009-08.2016	N54B30A		EPBBPT4-V006Z	96941	15	250
sDrive 35 is	2.979	250	6	03.2010-08.2016	N54B30A		EPBBPT4-V006Z	96941	15	250

CADILLAC

BLS

2.8 T AWD	2.792	206	6	10.2008-	Z28NET		EPBMPN3-V010Z	93991	10	117,5
2.8 T	2.792	206	6	12.2009-12.2010	Z28NET		EPBMPN3-V010Z	93991	10	117,5

BLS WAGON

2.8 T AWD	2.792	206	6	10.2008-	Z28NET		EPBMPN3-V010Z	93991	10	117,5
2.8 T	2.792	188	6	12.2007-	Z28NET		EPBMPN3-V010Z	93991	10	117,5

CHEVROLET

AVEO (T300)

1.2	1.229	51	4	03.2011-	LWD		EPBMPN3-V017Z	91253	10	120
1.2	1.229	63	4	03.2011-	LDC		EPBMPN3-V017Z	91253	10	120
1.2 LPG	1.229	63	4	11.2012-12.2015	LDC		EPBMPN3-V017Z	91253	10	120
1.4	1.398	74	4	03.2011-	LDD		EPBMPN3-V017Z	91253	10	120

AVEO / KALOS (T200)

1.4 16V	1.399	69	4	05.2003-05.2008	L14(85CUL4)		EPBMPN3-V021Z	92226		
1.4 16V	1.399	69	4	05.2003-05.2008	L14(85CUL4)		EPBMPN3-V018Z	97066	20	950

AVEO / KALOS (T250, T255)

1.2	1.150	53	4	03.2005-12.2007	LY4		EPBMPN3-V021Z	92226		
1.4	1.399	74	4	04.2008-	LDT		EPBMPN3-V017Z	91253	10	120
1.4	1.399	69	4	03.2005-12.2007	L14(85CUL4)		EPBMPN3-V021Z	92226		

CAMARO

3.6	3.564	241	6	09.2011-12.2015	LFX		EPBMPN3-V017Z	91253	10	120
6.2	6.162	298	8	09.2009-12.2015	L99		EPBMPN3-V017Z	91253	10	120
6.2	6.162	318	8	09.2009-12.2015	LS3		EPBMPN3-V017Z	91253	10	120
6.2	6.162	333	8	06.2016-	LT1		EPBMPN3-V017Z	91253	10	120
6.2	6.162	339	8	09.2015-	LT1		EPBMPN3-V017Z	91253	10	120
6.2 ZL1	6.162	432	8	09.2012-12.2015	LSA		EPBMPN3-V017Z	91253	10	120

CAPTIVA (C100, C140)

2.0 D, 2.0 D 4WD	1.991	93	4	10.2006-	LLW		EPBMPN3-V018Z	97066	20	950
2.0 D, 2.0 D 4WD	1.991	110	4	10.2006-	LLW		EPBMPN3-V018Z	97066	20	950
2.4, 2.4 4WD	2.384	123	4	03.2011-	LE5		EPBMPN3-V017Z	91253	10	120
3.0 4WD	2.997	186	6	01.2012-	LFW		EPBMPN3-V017Z	91253	10	120
3.0 4WD	2.997	190	6	11.2010-09.2018	LF1, LFW		EPBMPN3-V017Z	91253	10	120





CHEVROLET

CAPTIVA (C100, C140)

3.0 4WD	2.997	197	6	01.2012-	LFW	; Position: Air Filter Housing; ; Position: Intake Manifold	EPBMPN3-V017Z	91253	10	120
---------	-------	-----	---	----------	-----	--	---------------	-------	----	-----

CORVETTE (C7)

6.2	6.162	343	8	04.2014-	LT1		EPBMPN3-V017Z	91253	10	120
-----	-------	-----	---	----------	-----	--	---------------	-------	----	-----

CRUZE (J300, J305, J308)

1.4	1.398	74	4	07.2013-	LDD	; Position: Intake Manifold	EPBMPN3-V017Z	91253	10	120
1.4	1.364	103	4	09.2010-	LUJ		EPBMPN3-V017Z	91253	10	120
1.4	1.364	103	4	06.2012-	LUJ	; Position: Intake Manifold	EPBMPN3-V017Z	91253	10	120
1.4	1.364	103	4	08.2012-	LUJ	;	EPBMPN3-V017Z	91253	10	120
1.4	1.364	103	4	08.2012-	LUJ	; Position: Left	EPBBPN3-V029Z	92983	20	270
1.6	1.598	80	4	05.2009-	LXT		EPBMPN3-V018Z	97066	20	950
1.6	1.598	83	4	05.2009-	LDE		EPBMPN3-V041Z	92257	10	121,7
1.6	1.598	86	4	12.2012-	LDE		EPBMPN3-V017Z	91253	10	120
1.6	1.598	91	4	05.2009-	LDE		EPBMPN3-V041Z	92257	10	121,7
1.7 D	1.686	96	4	01.2012-	LUD		EPBBPT4-V001Z	92565	11	307
1.8	1.796	103	4	11.2009-	LUW	; Position: Intake Manifold	EPBMPN3-V041Z	92257	10	121,7
1.8	1.796	103	4	10.2011-	2H0		EPBMPN3-V041Z	92257	10	121,7
1.8	1.796	104	4	05.2009-	2H0		EPBMPN3-V041Z	92257	10	121,7
1.8 LPG	1.796	104	4	06.2011-	2H0		EPBMPN3-V041Z	92257	10	121,7
2.0 CDI	1.998	120	4	08.2010-	LNP		EPBBPT4-V001Z	92565	11	307

EPICA (KL1_) | TOSCA

2.0	1.998	94	4	01.2005-12.2006	L88	; Euro 2	EPBMPN3-V005Z	93871	20	100
2.0	1.998	94	4	01.2005-12.2006	L88		EPBMPN3-V018Z	97066	20	950
2.0	1.998	98	4	01.2005-12.2006	L88		EPBMPN3-V018Z	97066	20	950
2.0 D	1.991	110	4	01.2007-	LLW		EPBMPN3-V018Z	97066	20	950

EVANDA

2.0	1.998	96	4	03.2005-	L88		EPBMPN3-V018Z	97066	20	950
-----	-------	----	---	----------	-----	--	---------------	-------	----	-----

HHR

2.2	2.198	107	4	09.2005-12.2006	L61		EPBMPN3-V017Z	91253	10	120
2.2	2.198	108	4	01.2006-12.2011	L61		EPBMPN3-V017Z	91253	10	120
2.2	2.198	111	4	09.2005-12.2008	L61		EPBMPN3-V017Z	91253	10	120
2.4	2.384	125	4	10.2007-12.2011	LE5		EPBMPN3-V005Z	93871	20	100
2.4	2.384	128	4	01.2006-12.2011	LE5		EPBMPN3-V005Z	93871	20	100

LACETTI (J200)

1.4 16V	1.399	70	4	03.2005-	L14		EPBMPN3-V011Z	94242	20	115
1.4 16V	1.399	70	4	03.2005-	L14		EPBMPN3-V018Z	97066	20	950
1.6	1.598	80	4	03.2005-	L44, LXT		EPBMPN3-V011Z	94242	20	115
1.6	1.598	80	4	03.2005-	L44, LXT		EPBMPN3-V018Z	97066	20	950
1.8	1.796	89	4	08.2005-	LDA		EPBMPN3-V011Z	94242	20	115

MAP

 kW
C
Y
I

Type-N°

Stock-N°

kPa from

kPa to

CHEVROLET
LACETTI (J200)

1.8	1.796	89	4	08.2005-	LDA		EPBMPN3-V018Z	97066	20	950
1.8	1.796	90	4	03.2005-	LDA		EPBMPN3-V011Z	94242	20	115
1.8	1.796	90	4	03.2005-	LDA		EPBMPN3-V018Z	97066	20	950
2.0 D	1.991	89	4	01.2007-	LMN		EPBMPN3-V011Z	94242	20	115
2.0 D	1.991	89	4	01.2007-	LMN		EPBMPN3-V018Z	97066	20	950

MALIBU (V300)

2.4	2.384	123	4	01.2012-	LE9		EPBMPN3-V017Z	91253	10	120
2.4	2.384	125	4	01.2012-	LE9		EPBMPN3-V017Z	91253	10	120
3.0	2.997	196	6	04.2013-	LFW		EPBMPN3-V017Z	91253	10	120

MATIZ (M200, M250)

0.8	796	38	3	03.2005- 12.2013	LBF, LQ2		EPBMPN3-V021Z	92226		
0.8 LPG	796	38	3	03.2005-	LBF, LQ2		EPBMPN3-V021Z	92226		
1.0	995	47	4	03.2005- 12.2007	LQ4		EPBMPN3-V021Z	92226		
1.0	995	49	4	03.2005-	LQ4		EPBMPN3-V021Z	92226		
1.0 LPG	995	49	4	03.2005- 03.2011	L11, LA2, LQ4		EPBMPN3-V021Z	92226		

NUBIRA SALOON

1.4	1.399	70	4	01.2006- 12.2008	L14		EPBMPN3-V021Z	92226		
1.6	1.598	80	4	03.2005- 12.2011	L44, LXT		EPBMPN3-V011Z	94242	20	115
1.6	1.598	80	4	03.2005- 12.2011	L44, LXT		EPBMPN3-V018Z	97066	20	950
1.8	1.796	90	4	03.2005- 12.2009	LDA		EPBMPN3-V011Z	94242	20	115
1.8	1.796	90	4	03.2005- 12.2009	LDA		EPBMPN3-V018Z	97066	20	950

ORLANDO (J309)

1.4	1.362	103	4	06.2012-	LUJ		EPBBPN3-V029Z	92983	20	270
1.8	1.796	104	4	02.2011-	2H0		EPBMPN3-V041Z	92257	10	121,7
1.8 LPG	1.796	104	4	06.2011-	2H0		EPBMPN3-V041Z	92257	10	121,7

REZZO (U100)

1.6	1.598	77	4	03.2005-	L44		EPBMPN3-V011Z	94242	20	115
1.6	1.598	79	4	08.2005-	L44		EPBMPN3-V011Z	94242	20	115
2.0	1.998	89	4	03.2005-	L88		EPBMPN3-V005Z	93871	20	100
2.0	1.998	89	4	03.2005-	L88		EPBMPN3-V011Z	94242	20	115
2.0	1.998	90	4	08.2005-	L88		EPBMPN3-V005Z	93871	20	100
2.0	1.998	90	4	08.2005-	L88		EPBMPN3-V011Z	94242	20	115

SPARK

0.8	796	37	3	05.2005- 02.2010	LBF, LQ2		EPBMPN3-V021Z	92226		
1.0 SX	995	46	4	05.2005-	B10S, LA2		EPBMPN3-V021Z	92226		

SPARK (M300)

1.0 LPG	995	48	4	07.2010-	LMT		EPBMPN3-V017Z	91253	10	120
1.0	995	50	4	03.2010-	LMT		EPBMPN3-V017Z	91253	10	120
1.0 LPG	995	50	4	03.2010-	LMT		EPBMPN3-V017Z	91253	10	120



MAP



l kW
C
Y
I



Type-Nº

Stock-Nº

kPa from

kPa to

CHEVROLET

SPARK (M300)

1.2	1.206	60	4	03.2010-	LMU		EPBMPN3-V017Z	91253	10	120
1.2 LPG	1.206	60	4	03.2010-	LMU		EPBMPN3-V017Z	91253	10	120

TRAILBLAZER (31UX)

3.6 4WD	3.564	176	6	01.2013-	LY7		EPBMPN3-V017Z	91253	10	120
---------	-------	-----	---	----------	-----	--	---------------	-------	----	-----

TRAX | TRACKER

1.4 AWD	1.364	103	4	12.2012-	LUJ		EPBBPN3-V029Z	92983	20	270
1.8	1.796	103	4	03.2013-	2HO		EPBMPN3-V017Z	91253	10	120
1.8 AWD	1.796	103	4	03.2013-	2HO		EPBMPN3-V017Z	91253	10	120

VOLT

EV 150	1.398	111	4	11.2011-	LUU		EPBMPN3-V017Z	91253	10	120
--------	-------	-----	---	----------	-----	--	---------------	-------	----	-----

CHRYSLER

CIRRUS

2.0 LX	1.996	96	4	05.1994-09.1997	ECB		EPBMPT4-V044Z	96079	15	102
2.0 LX	1.996	98	4	10.1997-09.2000	ECB		EPBMPT4-V044Z	96079	15	102

CROSSFIRE

3.2	3.199	160	6	07.2003-12.2008	EGX		EPBMPN3-A004Z	90833	10	120
-----	-------	-----	---	-----------------	-----	--	---------------	-------	----	-----

NEON (PL)

1.8 16V	1.796	85	4	09.1997-08.1999	EBD		EPBMPT4-V044Z	96079	15	102
2.0 16V	1.996	107	4	06.1994-08.1999	ECC		EPBMPT4-V044Z	96079	15	102
2.0 16V	1.996	109	4	04.1996-08.1999	420T		EPBMPT4-V044Z	96079	15	102

SEBRING (JR)

2.0	1.996	104	4	04.2001-06.2007	ECC		EPBMPT4-V044Z	96079	15	102
-----	-------	-----	---	-----------------	-----	--	---------------	-------	----	-----

VOYAGER / GRAND VOYAGER III (GS) | TACUMA

2.5 TD	2.499	85	4	01.1995-03.2001	CLIRS		EPBBPT4-V012Z	96542	20	250
--------	-------	----	---	-----------------	-------	--	---------------	-------	----	-----

CITROËN

AX (ZA-_)

11	1.124	44	4	09.1986-12.1997	H1B, HDZ(TU1M)		EPBMPN3-A002Z	96249	15	100
----	-------	----	---	-----------------	----------------	--	---------------	-------	----	-----

BERLINGO (B9)

1.6 Hdi, BlueHdi 75	1.560	55	4	07.2010-	9HN(DV6ETED), BHW(DV6FE)		EPBMBT4-A003Z	93024	12,9	316,5
1.6 Hdi 75	1.560	55	4	04.2008-	9HT(DV6BTED4), 9HT(DV6BUTED4)		EPBBPN3-A001Z	94263	10	240
1.6 Hdi 75, BlueHdi 75	1.560	55	4	04.2008-	9HN(DV6ETED)	; Position: Intake Manifold	EPBMBT4-A003Z	93024	12,9	316,5
1.6 Hdi 75 16V	1.560	55	4	04.2008-	9HT(DV6BTED4)		EPBBPN3-A001Z	94263	10	240
1.6 Hdi 75 4x4	1.560	55	4	02.2012-	9HN(DV6ETED)		EPBBPN3-A001Z	94263	10	240
1.6 Hdi 75 4x4	1.560	55	4	02.2012-	9HN(DV6ETED)	; Position: Suction Pipe	EPBMBT4-A003Z	93024	12,9	316,5
1.6	1.587	66	4	04.2008-	NFR(TU5JP4B)		EPBMPT4-A001Z	93136	10	117
1.6 Hdi 90	1.560	66	4	04.2008-	9HX(DV6ATED4)		EPBBPN3-A001Z	94263	10	240
1.6 Hdi 90	1.560	66	4	07.2010-	9HF(DV6DTED)	; Position: Suction Pipe	EPBMBT4-A003Z	93024	12,9	316,5
1.6 Hdi 90 16V	1.560	66	4	04.2008-	9HS(DV6TED4BU), 9HX(DV6AUTED4)		EPBBPN3-A001Z	94263	10	240
1.6 Hdi 90 16V	1.560	66	4	04.2008-	9HX(DV6ATED4)	; Position: Intake Manifold	EPBBPN3-A001Z	94263	10	240



MAP



l kW
C
Y
I



Type-N°

Stock-N°

kPa from
kPa to

CITROËN

BERLINGO (B9)

1.6 HDi 90 4x4	1.560	66	4	02.2012-12.2014	9HF(DV6DTEd)		EPBBPN3-A001Z	94263	10	240
1.6 HDi 90 4x4	1.560	66	4	02.2012-12.2014	9HF(DV6DTEd)	; Position: Suction Pipe	EPBMBT4-A003Z	93024	12,9	316,5
1.6 HDi 90	1.560	68	4	07.2010-	9HJ(DV6DTEdM), 9HP(DV6DTEd)		EPBMBT4-A003Z	93024	12,9	316,5
1.6 HDi 92	1.560	68	4	07.2010-	9HP(DV6DTEdM)	; Position: Suction Pipe	EPBMBT4-A003Z	93024	12,9	316,5
1.6	1.587	80	4	04.2008-	NFU(TU5JP4)		EPBMPT4-A001Z	93136	10	117
1.6 HDi 110	1.560	80	4	04.2008-	9HZ(DV6TEd4)	; Position: Intake Manifold	EPBBPN3-A001Z	94263	10	240
1.6 HDi 110	1.560	82	4	07.2010-	9HR(DV6C), 9HL(DV6C)	; Position: Suction Pipe	EPBMBT4-A003Z	93024	12,9	316,5
1.6 HDi 115	1.560	84	4	07.2010-	9HR(DV6C)		EPBMBT4-A003Z	93024	12,9	316,5
1.6 HDi 115 4x4	1.560	84	4	02.2012-	9HR(DV6C)	; Position: Suction Pipe	EPBMBT4-A003Z	93024	12,9	316,5
1.6 VTi 120	1.598	88	4	-07.2010	5FS(EP6C)	; Org. No. to: 12294	EPBMPT4-A006Z	96115		

BERLINGO / BERLINGO FIRST BOX (M_)

1.1 i	1.124	44	4	07.1996-03.2008	HFX(TU1JP)		EPBMPT4-A001Z	93136	10	117
1.4 bivalent	1.360	48	4	11.2002-12.2011	KFW(TU3JP)		EPBMPN3-A003Z	92477	15	102
1.4 bivalent	1.360	48	4	11.2002-12.2011	KFW(TU3JP)		EPBMPT4-A001Z	93136	10	117
1.4 i	1.360	55	4	07.1996-12.2011	KFW(TU3A), KFW(TU3JP), KFX(TU3JP)		EPBMPT4-A001Z	93136	10	117
1.4 i	1.360	55	4	-11.1998	KFW(TU3JP), KFX(TU3JP)	; Number of Poles: 3	EPBMPN3-A009Z	92952	20	100
1.4 i	1.360	55	4	11.1998-	KFW(TU3JP), KFX(TU3JP)	; Number of Poles: 3	EPBMPN3-A007Z	96754	20	105
1.4 i bivalent (MBKFW)	1.360	55	4	04.2003-10.2005	KFW(TU3JP)		EPBMPN3-A003Z	92477	15	102
1.4 i bivalent (MBKFW)	1.360	55	4	04.2003-10.2005	KFW(TU3JP)		EPBMPT4-A001Z	93136	10	117
1.6 HDi 75 (MB9HW)	1.560	55	4	07.2005-12.2011	DV6B		EPBBPN3-A001Z	94263	10	240
1.6 HDi 90	1.560	66	4	07.2005-12.2011	9HX(DV6ATED4)		EPBBPN3-A001Z	94263	10	240
1.6 16V (MBNFU)	1.587	80	4	10.2000-03.2008	NFU(TU5JP4)		EPBMPT4-A001Z	93136	10	117
1.8 i	1.761	66	4	-11.1998	LFX(XU7JB)		EPBMPN3-A009Z	92952	20	100
1.8 i	1.761	66	4	11.1998-	LFX(XU7JB)		EPBMPN3-A007Z	96754	20	105

BERLINGO / BERLINGO FIRST MPV (MF, GJK, GFK)

1.1 i	1.124	44	4	07.1996-05.2008	HDZ(TU1M), HFX(TU1JP)		EPBMPT4-A001Z	93136	10	117
1.4 bivalent	1.360	48	4	11.2002-12.2011	KFW(TU3JP)		EPBMPN3-A003Z	92477	15	102
1.4 bivalent	1.360	48	4	11.2002-12.2011	KFW(TU3JP)		EPBMPT4-A001Z	93136	10	117
1.4 i	1.360	55	4	07.1996-12.2011	KFW(TU3JP), KFX(TU3JP)		EPBMPT4-A001Z	93136	10	117
1.4 i bivalent	1.360	55	4	04.2003-10.2008	KFW(TU3JP)		EPBMPN3-A003Z	92477	15	102
1.4 i bivalent	1.360	55	4	04.2003-10.2008	KFW(TU3JP)		EPBMPT4-A001Z	93136	10	117
1.6 HDi 75	1.560	55	4	07.2005-12.2011	DV6B		EPBBPN3-A001Z	94263	10	240
1.6 HDi 90	1.560	66	4	07.2005-05.2008	9HX(DV6ATED4)		EPBBPN3-A001Z	94263	10	240
1.6 16V	1.587	80	4	10.2000-12.2011	NFU(TU5JP4)		EPBMPT4-A001Z	93136	10	117
1.8 i, 1.8 i 4WD	1.761	66	4	-11.1998	LFX(XU7JB)		EPBMPN3-A009Z	92952	20	100
1.8 i, 1.8 i 4WD	1.761	66	4	11.1998-	LFX(XU7JB)		EPBMPN3-A007Z	96754	20	105



MAP



l kW
C
Y
I



Type-N°

Stock-N°

kPa from

kPa to

CITROËN

BX (XB-)

16, 16 E	1.580	65	4	05.1989-12.1994	BDY(XU5M), BDZ(XU5M)		EPBMPN3-A002Z	96249	15	100
19, 19 E	1.905	80	4	06.1988-12.1994	DDZ(XU9M)		EPBMPN3-A003Z	92477	15	102
19 4x4	1.905	80	4	10.1990-05.1991	DDZ(XU9M)		EPBMPN3-A003Z	92477	15	102

C1 (PM_, PN_)

1.0	998	50	3	06.2005-09.2014	CFB(1KR)		EPBMPT4-A030Z	96501	10	130
1.4 HDi	1.398	40	4	06.2005-09.2014	8HT(DV4TD)		EPBBPN3-A006Z	91736	10	240

C1 II (PA_, PS_)

1.0 VTi 68	998	51	3	04.2014-	CFB(1KR)		EPBMPT4-A030Z	96501	10	130
1.0 VTi 72	998	53	3	06.2018-	CFB(1KR)		EPBMPT4-A030Z	96501	10	130

C2 (JM_, JG_)

1.1	1.124	44	4	09.2003-09.2012	HFX(TU1A), HFX(TU1JP)		EPBMPT4-A001Z	93136	10	117
1.4 HDi	1.398	50	4	07.2003-12.2009	8HX(DV4TD), 8HZ(DV4TD)		EPBBPN3-A006Z	91736	10	240
1.4 HDi	1.398	51	4	09.2003-04.2005	8HX(DV4TD)		EPBBPN3-A006Z	91736	10	240
1.4	1.360	54	4	09.2003-12.2009	KFV(TU3A), KFV(TU3JP)		EPBMPT4-A001Z	93136	10	117
1.4 16V	1.360	65	4	04.2005-12.2009	KFU(ET3J4)		EPBMPT4-A001Z	93136	10	117
1.6	1.587	80	4	07.2003-10.2010	NFU(TU5JP4)		EPBMPT4-A001Z	93136	10	117
1.6 HDi	1.560	80	4	09.2005-12.2009	9HZ(DV6TED4)		EPBBPN3-A001Z	94263	10	240
1.6 VTS	1.587	90	4	10.2004-12.2009	NFS(TU5JP4S)		EPBMPT4-A001Z	93136	10	117

C3 I (FC_, FN_)

1.1 i	1.124	44	4	02.2002-	HFX(TU1A), HFX(TU1JP)		EPBMPT4-A001Z	93136	10	117
1.4 HDi	1.398	50	4	02.2002-	8HX(DV4TD)	; For L5; Position: Suction Pipe	EPBBPN3-A006Z	91736	10	240
1.4 i	1.360	54	4	02.2002-11.2010	KFV(TU3A), KFV(TU3JP)		EPBMPT4-A001Z	93136	10	117
1.4 i Bivalent	1.360	54	4	02.2002-	KFV(TU3JP)		EPBMPT4-A001Z	93136	10	117
1.4 HDi	1.398	55	4	05.2005-	8HX(DV4TD)	; For L5; Position: Suction Pipe	EPBBPN3-A006Z	91736	10	240
1.4 16V	1.360	65	4	12.2003-	KFU(ET3J4)		EPBMPT4-A001Z	93136	10	117
1.4 16V HDi	1.398	66	4	02.2002-	8HY(DV4TED4)		EPBBPN3-A001Z	94263	10	240
1.6 16V HDi	1.560	66	4	10.2005-	9HX(DV6ATED4)		EPBBPN3-A001Z	94263	10	240
1.6 16V	1.587	80	4	02.2002-08.2010	NFU(TU5JP4)		EPBMPT4-A001Z	93136	10	117
1.6 16V HDi	1.560	80	4	09.2005-	9HZ(DV6TED4)		EPBBPN3-A001Z	94263	10	240

C3 II (SC_)

1.1 i	1.124	44	4	11.2009-01.2013	HFX(TU1JP)	; Position: Intake Manifold	EPBMPT4-A001Z	93136	10	117
1.4 HDi	1.398	50	4	06.2010-09.2016	8HR(DV4C)		EPBBPN3-A017Z	95311	35	320
1.4 HDi 70	1.398	50	4	11.2009-	8HZ(DV4TD)	; Position: Intake Manifold	EPBBPN3-A006Z	91736	10	240
1.4 HDi 70	1.398	50	4	11.2009-	8HR(DV4C)	; Position: Intake Manifold	EPBBPN3-A017Z	95311	35	320
1.4	1.360	54	4	11.2009-09.2016	KFV(TU3A), KFT(TU3A)	; Position: Intake Manifold	EPBMPT4-A001Z	93136	10	117
1.6 HDi	1.560	68	4	11.2009-09.2016	9HJ(DV6DTEDM), 9HP(DV6DTEDE)		EPBMBT4-A003Z	93024	12,9	316,5
1.6 HDi 110	1.560	82	4	11.2009-	9HR(DV6C)		EPBMBT4-A003Z	93024	12,9	316,5
1.6 HDi 115	1.560	84	4	09.2012-	9HD(DV6C)	; Position: Suction Pipe	EPBMBT4-A003Z	93024	12,9	316,5



MAP

 kW
C
Y
I

Type-N°

Stock-N°

 kPa from
kPa to

CITROËN
C3 PICASSO (SH_)

1.4 VTi 95	1.397	70	4	02.2009-	8FN(EP3), 8FP(EP3C), 8FS(EP3)	; Position: Intake Manifold	EPBMPT4-A006Z	96115		
1.6 HDi	1.560	66	4	02.2009-	9HX(DV6ATED4)	; Position: Intake Manifold	EPBBPN3-A001Z	94263	10	240
1.6 HDi 90	1.560	68	4	07.2010-	9HP(DV6DTED)		EPBMBT4-A003Z	93024	12,9	316,5
1.6 HDi	1.560	80	4	02.2009-	9HZ(DV6TED4)	; Position: Intake Manifold	EPBBPN3-A001Z	94263	10	240
1.6 HDi 110	1.560	82	4	05.2010-	9HR(DV6C)		EPBMBT4-A003Z	93024	12,9	316,5
1.6 HDi 115	1.560	84	4	01.2013-	9HD(DV6C)		EPBMBT4-A003Z	93024	12,9	316,5
1.6 VTi 120	1.598	88	4	02.2009-	5FS(EP6C), 5FW(EP6)		EPBMPT4-A006Z	96115		

C3 PLURIEL (HB_)

1.4 HDi	1.398	50	4	04.2004-	8HX(DV4TD)	; Position: Suction Pipe	EPBBPN3-A006Z	91736	10	240
1.4	1.360	54	4	05.2003-	KFV(TU3A), KFV(TU3JP)		EPBMPT4-A001Z	93136	10	117
1.6	1.587	80	4	05.2003-	NFU(TU5JP4)		EPBMPT4-A001Z	93136	10	117

C4 AIRCROSS

1.6 HDi 115	1.560	84	4	04.2012-	9HD(DV6C)		EPBMBT4-A003Z	93024	12,9	316,5
1.6 HDi 115 AWC	1.560	84	4	05.2012-	9HL(DV6C)		EPBMBT4-A003Z	93024	12,9	316,5

C4 CACTUS

1.6 HDi 90	1.560	68	4	09.2014-	9HP(DV6DTED)	; Position: Suction Pipe	EPBMBT4-A003Z	93024	12,9	316,5
------------	-------	----	---	----------	--------------	--------------------------	---------------	-------	------	-------

C4 GRAND PICASSO I (UA_)

1.6 HDi	1.560	80	4	10.2006- 06.2011	9HZ(DV6TED4), 9HY(DV6TED4)	; Position: Suction Pipe	EPBBPN3-A001Z	94263	10	240
1.6 HDi 110	1.560	82	4	09.2010- 08.2013	9HR(DV6C)		EPBMBT4-A003Z	93024	12,9	316,5
1.6 VTi 120	1.598	88	4	07.2008- 08.2013	5FW(EP6)		EPBMPT4-A006Z	96115		
1.6 16V	1.598	103	4	07.2008- 12.2010	5FT(EP6DT)		EPBBPN3-A024Z	91449	50	350
1.6 16V	1.598	110	4	10.2008- 08.2013	5FX(EP6DT)		EPBBPN3-A024Z	91449	50	350
1.6 THP 155	1.598	115	4	09.2010- 08.2013	5FV(EP6CDT)		EPBBPN3-V030Z	94092	50	465
1.8 i 16V	1.749	92	4	10.2006- 12.2010	6FY(EW7A)		EPBMPT4-A001Z	93136	10	117
2.0 HDi 138	1.997	100	4	10.2006- 12.2013	RHJ(DW10BTED4), RHR(DW10BTED4)	; Position: Suction Pipe	EPBBPN3-A001Z	94263	10	240
2.0 i 16V	1.997	103	4	10.2006- 08.2013	RFJ(EW10A)		EPBMPT4-A001Z	93136	10	117
2.0 HDi 150	1.997	110	4	07.2009- 08.2013	RHE(DW10CTED4)		EPBMBT4-A003Z	93024	12,9	316,5
2.0 HDi 165	1.997	120	4	09.2010- 08.2013	RHH(DW10CTED4)		EPBMBT4-A003Z	93024	12,9	316,5

C4 GRAND PICASSO II (DA_, DE_)

1.6 HDi 90	1.560	68	4	09.2013-	9HP(DV6DTED)		EPBMBT4-A003Z	93024	12,9	316,5
1.6 HDi, BlueHDi 115	1.560	85	4	09.2013-	9HC(DV6C)	; Position: Suction Pipe	EPBMBT4-A003Z	93024	12,9	316,5
1.6 THP 155	1.598	115	4	09.2013-	5FV(EP6CDT)		EPBBPN3-V030Z	94092	50	465
1.6 THP 165	1.598	121	4	07.2014-	5GZ(EP6FDT)		EPBBPN3-V030Z	94092	50	465

C4 I (LC_, DU_, LA_)

1.4 16V	1.360	65	4	11.2004- 07.2011	KFU(ET3J4)		EPBMPT4-A001Z	93136	10	117
1.6 HDi	1.560	66	4	11.2004- 07.2011	9HX(DV6ATED4)		EPBBPN3-A001Z	94263	10	240
1.6 16V	1.587	80	4	11.2004- 07.2011	NFU(TU5JP4)		EPBMPT4-A001Z	93136	10	117
1.6 16V Bio-Flex	1.587	80	4	09.2007- 07.2008	NFU(TU5JP4)		EPBMPT4-A001Z	93136	10	117





Type-N°

Stock-N°

kPa from
kPa to

CITROËN

C4 I (LC_, DU_, LA_)

1.6 HDi	1.560	80	4	11.2004-07.2011	9HZ(DV6TED4), 9HY(DV6TED4)		EPBBPN3-A001Z	94263	10	240
1.6 VTi 120	1.598	88	4	07.2008-07.2011	5FW(EP6)		EPBBPN3-A024Z	91449	50	350
1.6 THP 140	1.598	103	4	06.2008-07.2011	5FT(EP6DT)		EPBBPN3-A024Z	91449	50	350
1.6 THP 150	1.598	110	4	07.2008-07.2011	5FX(EP6DT)		EPBBPN3-A024Z	91449	50	350
2.0 HDi	1.997	81	4	04.2007-07.2008	RHZ(DW10ATED)		EPBBPN3-A001Z	94263	10	240
2.0 16V	1.997	100	4	11.2004-07.2007	RFN(EW10J4)		EPBMPN3-A020Z	96725	20	117
2.0 HDi	1.997	100	4	11.2004-07.2011	RHR(DW10BTED4)		EPBBPN3-A001Z	94263	10	240
2.0 16V	1.997	103	4	11.2004-07.2011	RFJ(EW10A)		EPBMPT4-A001Z	93136	10	117
2.0 16V	1.997	130	4	11.2004-07.2008	RFK(EW10J4S)		EPBMPT4-A001Z	93136	10	117

C4 II (B7)

1.6 HDi 90	1.560	68	4	11.2009-	9HJ(DV6DTEDM), 9HP(DV6DTED)		EPBMBT4-A003Z	93024	12,9	316,5
1.6 HDi 110	1.560	82	4	11.2009-	9HR(DV6C)		EPBMBT4-A003Z	93024	12,9	316,5
1.6 HDi 115	1.560	84	4	07.2012-	9HD(DV6C)		EPBMBT4-A003Z	93024	12,9	316,5
1.6 THP 155	1.598	115	4	11.2009-12.2016	5FV(EP6CDT)		EPBBPN3-V030Z	94092	50	465
2.0 HDi / BlueHDi 150	1.997	110	4	11.2009-	AHR(DW10FD), RHE(DW10CTED4)		EPBMBT4-A003Z	93024	12,9	316,5

C4 PICASSO I MPV (UD_)

1.6 HDi	1.560	80	4	02.2007-08.2013	9HZ(DV6TED4), 9HY(DV6TED4)	; Position: Suction Pipe	EPBBPN3-A001Z	94263	10	240
1.6 HDi 110	1.560	82	4	09.2010-08.2013	9HR(DV6C)		EPBMBT4-A003Z	93024	12,9	316,5
1.6 VTi 120	1.598	88	4	07.2008-08.2013	5FW(EP6)		EPBMPT4-A006Z	96115		
1.6 THP 140	1.598	103	4	07.2008-08.2013	5FT(EP6DT)		EPBBPN3-A024Z	91449	50	350
1.6 16V	1.598	110	4	07.2008-08.2013	5FX(EP6DT)		EPBBPN3-A024Z	91449	50	350
1.6 THP 155	1.598	115	4	09.2010-08.2013	5FV(EP6CDT)		EPBBPN3-V030Z	94092	50	465
1.8 i 16V	1.749	92	4	02.2007-12.2011	6FY(EW7A)		EPBMPT4-A001Z	93136	10	117
2.0 HDi 138	1.997	100	4	10.2006-08.2013	RHJ(DW10BTED4), RHR(DW10BTED4)	; Position: Suction Pipe	EPBBPN3-A001Z	94263	10	240
2.0 i 16V	1.997	103	4	09.2007-08.2013	RFJ(EW10A)		EPBMPT4-A001Z	93136	10	117
2.0 HDi 150	1.997	110	4	07.2009-08.2013	RHE(DW10CTED4)		EPBMBT4-A003Z	93024	12,9	316,5
2.0 HDi 165	1.997	120	4	09.2010-08.2013	RHH(DW10CTED4)		EPBMBT4-A003Z	93024	12,9	316,5

C4 PICASSO II

1.6 HDi 90	1.560	68	4	02.2013-	9HP(DV6DTED)		EPBMBT4-A003Z	93024	12,9	316,5
1.6 THP 155	1.598	115	4	02.2013-	5FV(EP6CDT)		EPBBPN3-V030Z	94092	50	465
1.6 THP 165	1.598	121	4	07.2014-	5GZ(EP6FDT)		EPBBPN3-V030Z	94092	50	465

C5 I (DC_, DE_, RE)

1.8 16V	1.749	85	4	03.2001-08.2004	6FZ(EW7J4)		EPBMPN3-A020Z	96725	20	117
2.0 HDi	1.997	66	4	-09.2003	RHY(DW10TD)		EPBBPN3-A003Z	91268	10	250
2.0 HDi	1.997	66	4	09.2003-	RHY(DW10TD)		EPBBPN3-A006Z	91736	10	240
2.0 HDi	1.997	79	4	-09.2003	RHS(DW10ATED), RHZ(DW10ATED)	; RPO<09820	EPBBPN3-A003Z	91268	10	250
2.0 HDi	1.997	79	4	10.2003-	RHS(DW10ATED), RHZ(DW10ATED)	; RPO>09821	EPBBPN3-A006Z	91736	10	240

MAP



l kW
C
Y
I



Type-N°

Stock-N°

kPa from
kPa to

CITROËN

C5 I (DC_, DE_, RE)

2.0 HDi	1.997	80	4	-09.2003	RHZ(DW10ATED)	; RPO<09820	EPBBPN3-A003Z	91268	10	250
2.0 HDi	1.997	80	4	09.2003-	RHZ(DW10ATED)	; RPO>09821	EPBBPN3-A006Z	91736	10	240
2.0 16V	1.997	100	4	03.2001- 08.2004	RFN(EW10J4)		EPBMPN3-A020Z	96725	20	117
2.0 16V Hpi	1.997	103	4	03.2001- 08.2004	RLZ(EW10D)		EPBMPN3-A020Z	96725	20	117
2.2 HDi	2.179	98	4	-06.2003	4HX(DW12TED4)		EPBBPN3-A003Z	91268	10	250
2.2 HDi	2.179	98	4	06.2003-	4HX(DW12TED4)		EPBBPN3-A006Z	91736	10	240
3.0 V6	2.946	152	6	03.2001- 08.2004	XFJ(ES9J4S)		EPBMPN3-A020Z	96725	20	117
3.0 Carlsson	2.946	173	6	09.2003- 08.2004	XFJ(ES9J4S)		EPBMPN3-A020Z	96725	20	117

C5 II (RC_, RE_)

1.6 HDi	1.560	80	4	09.2004-	9HZ(DV6TED4), 9HY(DV6TED4)		EPBBPN3-A001Z	94263	10	240
1.8 16V	1.749	85	4	09.2004-	6FZ(EW7J4)		EPBMPN3-A020Z	96725	20	117
1.8 16V	1.749	92	4	09.2005-	6FY(EW7A)		EPBMPT4-A001Z	93136	10	117
2.0 HDi	1.997	100	4	09.2004-	RHR(DW10BTED4)		EPBBPN3-A001Z	94263	10	240
2.0 16V	1.997	103	4	09.2004-	RFJ(EW10A)		EPBMPT4-A001Z	93136	10	117
2.2 HDi	2.179	98	4	09.2004-	4HX(DW12TED4)		EPBBPN3-A006Z	91736	10	240
2.2 HDi	2.179	120	4	05.2006-	4HP(DW12BTED4), 4HR(DW12BTED4)		EPBBPN3-A018Z	95753	35	320
2.2 HDi	2.179	125	4	04.2006-	4HT(DW12BTED4)		EPBBPN3-A018Z	95753	35	320
3.0 V6	2.946	152	6	09.2004-	XFU(ES9A), XFJ(ES9J4S)		EPBMPN3-A020Z	96725	20	117

C5 III (RD_, RW_)

1.6 HDi 110	1.560	80	4	02.2008-	9HZ(DV6TED4)	; Position: Intake Manifold	EPBBPN3-A001Z	94263	10	240
1.6 HDi 110	1.560	82	4	07.2010-	9HL(DV6C), 9HR(DV6C)		EPBMBT4-A003Z	93024	12,9	316,5
1.6 HDi 115	1.560	84	4	01.2012-	9HL(DV6C), 9HR(DV6C)		EPBMBT4-A003Z	93024	12,9	316,5
1.6 THP 150	1.598	110	4	07.2010-	5FN(EP6CDT)		EPBBPN3-V030Z	94092	50	465
1.6 THP 150	1.598	110	4	-07.2010	5FN(EP6CDT)		EPBBPN3-A024Z	91449	50	350
1.6 THP 150	1.598	110	4	04.2009-	5FN(EP6CDT)		EPBBPN3-V030Z	94092	50	465
1.6 THP 155	1.598	115	4	-06.2010	5FV(EP6CDT)		EPBBPN3-A024Z	91449	50	350
1.6 THP 155	1.598	115	4	04.2009-	5FV(EP6CDT)		EPBBPN3-V030Z	94092	50	465
1.8 16V	1.749	92	4	02.2008-	6FY(EW7A)		EPBMPT4-A001Z	93136	10	117
2.0 HDi	1.997	100	4	02.2008-	RHF(DW10BTED4), RHR(DW10BTED4)	; Position: Intake Manifold	EPBBPN3-A001Z	94263	10	240
2.0 16V	1.997	103	4	02.2008-	RFJ(EW10A)		EPBMPT4-A001Z	93136	10	117
2.0 HDi 140	1.997	103	4	11.2008-	RHF(DW10BTED4)	; Position: Suction Pipe	EPBBPN3-A001Z	94263	10	240
2.0 HDi 140	1.997	103	4	04.2009-	RHF(DW10BTED4)	; Position: Intake Manifold	EPBBPN3-A001Z	94263	10	240
2.0 HDi 150, BlueHDi 150	1.997	110	4	04.2009-	AHR(DW10FD), RHE(DW10CTED4)	; Position: Suction Pipe	EPBMBT4-A003Z	93024	12,9	316,5
2.0 HDi 165	1.997	120	4	04.2009-	RHH(DW10CTED4)	; Position: Suction Pipe	EPBMBT4-A003Z	93024	12,9	316,5
2.2 HDi	2.179	120	4	04.2009- 12.2011	4HP(DW12BTED4), 4HR(DW12BTED4)		EPBBPN3-A018Z	95753	35	320
2.2 HDi 165	2.179	120	4	02.2008-	4HP(DW12BTED4)		EPBBPN3-A018Z	95753	35	320
2.2 HDi	2.179	125	4	02.2008-	4HT(DW12BTED4)		EPBBPN3-A018Z	95753	35	320



MAP



l kW
C
Y
I



Type-N°

Stock-N°

kPa from

kPa to

CITROËN

C5 III (RD_,RW_)

2.2 HDi 200	2.179	150	4	07.2010-	4HL(DW12C)		EPBBPN3-A018Z	95753	35	320
3.0 V6	2.946	155	6	02.2008-	XFU(ES9A), XFV(ES9A)		EPBMPN3-A020Z	96725	20	117

C6 (TD_)

2.2 HDi	2.179	120	4	06.2006- 12.2010	4HP(DW12BTED4)		EPBBPN3-A018Z	95753	35	320
2.2 HDi	2.179	125	4	06.2006- 12.2012	4HT(DW12BTED4)		EPBBPN3-A018Z	95753	35	320
3.0 V6	2.946	155	6	09.2005- 12.2012	XFV(ES9A), XFJ(ES9J4S)		EPBMPN3-A020Z	96725	20	117

C8 (EA_, EB_)

2.0 HDi	1.997	79	4	07.2002-	RHT(DW10ATED4), RHM(DW10ATED4)	; For vehicles without self-diagnosis system	EPBBPN3-A003Z	91268	10	250
2.0 HDi	1.997	79	4	07.2002-	RHT(DW10ATED4), RHM(DW10ATED4)	; For vehicles with self-diagnosis system	EPBBPN3-A006Z	91736	10	240
2.0 HDi	1.997	80	4	-05.2003	RHW(DW10ATED4)	; RPO<09701	EPBBPN3-A003Z	91268	10	250
2.0 HDi	1.997	80	4	06.2003-	RHW(DW10ATED4)	; RPO>09702	EPBBPN3-A006Z	91736	10	240
2.0 HDi	1.997	81	4	-05.2003	RHT(DW10ATED4)	; RPO<09701	EPBBPN3-A003Z	91268	10	250
2.0 HDi	1.997	81	4	06.2003-	RHT(DW10ATED4)	; RPO>09702	EPBBPN3-A006Z	91736	10	240
2.0 HDi	1.997	88	4	07.2006-	RHK(DW10UTED4)		EPBBPN3-A001Z	94263	10	240
2.0	1.997	100	4	07.2002-	RFN(EW10J4)		EPBMPN3-A020Z	96725	20	117
2.0 HDi 135	1.997	100	4	03.2006-	RHD(DW10CB), RHD(DW10CTED4), RHR(DW10BTED4)		EPBBPN3-A001Z	94263	10	240
2.0 HDi 135	1.997	100	4	03.2006-	RHD(DW10CB)		EPBMBT4-A003Z	93024	12,9	316,5
2.0 16V	1.997	103	4	09.2005-	RFJ(EW10A)		EPBMPT4-A001Z	93136	10	117
2.0 HDi 165	1.997	120	4	03.2006-	RHH(DW10CTED4)		EPBMBT4-A003Z	93024	12,9	316,5
2.2 HDi	2.179	94	4	07.2002-	4HW(DW12TED4)	; For vehicles without self-diagnosis system	EPBBPN3-A003Z	91268	10	250
2.2 HDi	2.179	94	4	07.2002-	4HW(DW12TED4)	; For vehicles with self-diagnosis system	EPBBPN3-A006Z	91736	10	240
2.2 HDi	2.179	120	4	06.2007-	4HP(DW12BTED4), 4HR(DW12BTED4)		EPBBPN3-A018Z	95753	35	320
2.2 HDi	2.179	125	4	06.2006-	4HT(DW12BTED4)		EPBBPN3-A018Z	95753	35	320
2.2	2.230	116	4	07.2002-	3FZ(EW12J4)	; Position: Intake Manifold	EPBMPN3-A007Z	96754	20	105
3.0 V6	2.946	150	6	07.2002-	XFJ(ES9J4S)		EPBMPN3-A020Z	96725	20	117

C-CROSSER (VU_, VV_)

2.2 HDi	2.179	115	4	02.2007-	4HN(DW12MTED4), 4HK(DW12ME5)		EPBBPN3-A018Z	95753	35	320
---------	-------	-----	---	----------	---------------------------------	--	---------------	-------	----	-----

C-ELYSEE (DD_)

1.6 HDi 92	1.560	68	4	11.2012-	9HP(DV6DTED), 9HJ(DV6DTEDM)	; Position: Suction Pipe	EPBMBT4-A003Z	93024	12,9	316,5
------------	-------	----	---	----------	--------------------------------	--------------------------	---------------	-------	------	-------

DS3

1.4 HDi 70	1.398	50	4	04.2010- 07.2015	8HR(DV4C)	; Position: Intake Manifold	EPBBPN3-A017Z	95311	35	320
1.4 VTi 95	1.397	70	4	04.2010- 07.2015	8FP(EP3C)		EPBMPT4-A006Z	96115		
1.6 HDi 90	1.560	68	4	11.2009- 07.2015	9HP(DV6DTED)		EPBMBT4-A003Z	93024	12,9	316,5
1.6 HDi 110	1.560	82	4	11.2009- 07.2015	9HR(DV6C)		EPBMBT4-A003Z	93024	12,9	316,5
1.6 HDi 115	1.560	84	4	08.2012- 07.2015	9HD(DV6C)		EPBMBT4-A003Z	93024	12,9	316,5
1.6 VTi 120	1.598	88	4	04.2010- 07.2015	5FS(EP6C)		EPBMPT4-A006Z	96115		



MAP



l kW
C
Y
I



Type-N°

Stock-N°

kPa from
kPa to

CITROËN

DS3

1.6 THP 150	1.598	110	4	01.2013-07.2015	5FN(EP6CDT)		EPBBPN3-V030Z	94092	50	465
1.6 THP 150	1.598	110	4	01.2010-07.2015	5FX(EP6DT), 5FN(EP6CDT)	; Position: Intake Manifold;	EPBBPN3-A024Z	91449	50	350
1.6 THP 155	1.598	115	4	04.2010-07.2015	5FR(EP6DT), 5FV(EP6CDT)		EPBBPN3-V030Z	94092	50	465
1.6 THP 155	1.598	115	4	04.2010-07.2015	5FR(EP6DT)	; Position: Intake Manifold	EPBBPN3-A024Z	91449	50	350
1.6 THP 155	1.598	115	4	04.2010-07.2015	5FV(EP6CDT)	; Position: Intake Manifold;	EPBBPN3-A024Z	91449	50	350
1.6 THP 165	1.598	120	4	01.2012-07.2015	5FM(EP6DT)	; Position: Intake Manifold	EPBBPN3-A024Z	91449	50	350
1.6 THP 165	1.598	121	4	10.2014-06.2015	5GZ(EP6FDT)		EPBBPN3-V030Z	94092	50	465
1.6 Racing	1.598	149	4	02.2011-07.2015	5FF(EP6DTS)		EPBBPN3-A024Z	91449	50	350
1.6 Racing	1.598	149	4	03.2011-	5FU(EP6CDTX)		EPBBPN3-V030Z	94092	50	465
1.6 Racing	1.598	152	4	02.2011-07.2015	5FD(EP6DTS)		EPBBPN3-A024Z	91449	50	350

DS4

1.6 HDi 90	1.560	68	4	05.2011-07.2015	9HP(DV6DTE)		EPBMBT4-A003Z	93024	12,9	316,5
1.6 HDi 110	1.560	82	4	04.2011-07.2015	9HR(DV6C)		EPBMBT4-A003Z	93024	12,9	316,5
1.6 HDi 115	1.560	84	4	08.2012-07.2015	9HD(DV6C)		EPBMBT4-A003Z	93024	12,9	316,5
1.6 THP 150	1.598	110	4	04.2011-07.2015	5FE(EP6CDTMD)		EPBBPN3-A024Z	91449	50	350
1.6 THP 155	1.598	115	4	04.2011-07.2015	5FV(EP6CDT)		EPBBPN3-V030Z	94092	50	465
1.6 THP 160	1.598	120	4	04.2012-07.2015	5FM(EP6CDTM)		EPBBPN3-A024Z	91449	50	350
1.6 THP 165	1.598	121	4	-01.2015	5FM(EP6CDTM), 5GZ(EP6FDT)		EPBBPN3-V030Z	94092	50	465
1.6 THP 200	1.598	147	4	04.2011-07.2015	5FU(EP6DTX)		EPBBPN3-V030Z	94092	50	465
2.0 HDi 165	1.997	120	4	04.2011-07.2015	RHH(DW10CTED4)		EPBMBT4-A003Z	93024	12,9	316,5

DS5

1.6 HDi 110	1.560	82	4	11.2011-07.2015	9HR(DV6C)		EPBMBT4-A003Z	93024	12,9	316,5
1.6 THP 150	1.598	110	4	11.2011-07.2015	5FE(EP6CDTMD)		EPBBPN3-A024Z	91449	50	350
1.6 THP 155	1.598	115	4	11.2011-07.2015	5FV(EP6CDT)		EPBBPN3-V030Z	94092	50	465
1.6 THP 165	1.598	121	4	01.2012-07.2015	5FM(EP6CDTM), 5FM(EP6DT), 5GZ(EP6FDT)		EPBBPN3-V030Z	94092	50	465
1.6 THP 165 Hybrid	1.598	121	4	01.2015-04.2015	5GZ(EP6FDT)		EPBBPN3-V030Z	94092	50	465
1.6 THP 200	1.598	147	4	11.2011-07.2015	5FU(EP6DTX)		EPBBPN3-V030Z	94092	50	465
2.0 HDi 135	1.997	100	4	11.2011-07.2015	RHD(DW10CD)	; Position: Suction Pipe	EPBMBT4-A003Z	93024	12,9	316,5
2.0 HDi 165	1.997	120	4	11.2011-07.2015	RHH(DW10CTED4)		EPBMBT4-A003Z	93024	12,9	316,5
2.0 HDi 165 Hybrid4 4x4	1.997	120	4	12.2011-07.2015	RHC(DW10CTED4)		EPBMBT4-A003Z	93024	12,9	316,5

EVASION MPV (22, U6) | SYNERGIE

1.8	1.761	73	4	05.1997-07.2002	LFZ(XU7JP)		EPBMPN3-A002Z	96249	15	100
2.0 HDI	1.997	80	4	08.1999-07.2002	RHZ(DW10ATED)		EPBBPN3-A003Z	91268	10	250
2.0 HDi 16V	1.997	80	4	09.1999-07.2002	RHW(DW10ATED4)		EPBBPN3-A003Z	91268	10	250
2.0	1.998	89	4	06.1994-07.2002	RFU(XU10J2C)		EPBMPN3-A002Z	96249	15	100
2.0 16V	1.998	97	4	-12.1998	RFV(XU10J4R)		EPBMPN3-A009Z	92952	20	100
2.0 16V	1.997	100	4	05.2000-07.2002	RFN(EW10J4)		EPBMPN3-A007Z	96754	20	105



CITROËN

EVASION MPV (22, U6) | SYNERGIE

2.1 TD	2.088	80	4	05.1996-07.2002	P8C(XUD11BTE)		EPBBPN3-A027Z	92471	10	200
--------	-------	----	---	-----------------	---------------	---	---------------	-------	----	-----

JUMPER

2.2 HDi 100	2.198	74	4	04.2006-	4HV(P22DTE)		EPBBPT4-A011Z	94601	20	300
2.2 HDi 110	2.198	81	4	07.2011-	4HG(P22DTE)		EPBMPN3-V019Z	93061	10	307,5
2.2 HDi 120	2.198	88	4	04.2006-	4HU(P22DTE)		EPBBPT4-A011Z	94601	20	300
2.2 HDi 130	2.198	96	4	07.2011-	4HH(P22DTE)	 ; Equip. Var. PUMAC	EPBMPN3-V019Z	93061	10	307,5
2.2 HDi 150	2.198	110	4	07.2011-	4HJ(P22DTE)		EPBMPN3-V019Z	93061	10	307,5
3.0 HDi 145	2.999	107	4	07.2010-	F30DTE(F1CE3481N)		EPBBPT4-V001Z	92565	11	307
3.0 HDi 160	2.999	116	4	09.2006-	F1CE0481D(F30DT)		EPBBPT4-V001Z	92565	11	307

JUMPER (230L, 230P, 244, Z_)

2.0 HDI	1.997	62	4	11.2001-04.2002	RHV(DW10TD)		EPBMPN3-A002Z	96249	15	100
2.0 HDi	1.997	62	4	04.2002-	RHV(DW10UTD)		EPBMPN3-A002Z	96249	15	100
2.0	1.998	80	4	03.1994-04.2002	RFW(XU10J2U)		EPBMPN3-A002Z	96249	15	100
2.0 4x4	1.998	80	4	08.1996-04.2002	RFW(XU10J2U)		EPBMPN3-A002Z	96249	15	100
2.0	1.998	81	4	04.2002-	XU10J2		EPBMPN3-A002Z	96249	15	100
2.0 bivalent	1.998	81	4	02.2003-	XU10J2		EPBMPN3-A002Z	96249	15	100
2.2 HDi	2.179	74	4	04.2002-	4HY(DW12UTED)		EPBMPN3-A002Z	96249	15	100
2.8 D	2.798	64	4	01.1999-02.2002	8140.63(F28D)		EPBMPN3-A002Z	96249	15	100
2.8 HDi	2.798	94	4	09.2000-04.2002	8140.43S		EPBMPN3-A002Z	96249	15	100
2.8 HDi 4x4	2.798	94	4	09.2000-04.2002	8140.43S		EPBMPN3-A002Z	96249	15	100

JUMPER | RELAY

2.2 HDi 100	2.198	74	4	04.2006-12.2012	4HV(P22DTE)		EPBBPT4-A011Z	94601	20	300
2.2 HDi 110	2.198	81	4	07.2011-	4HG(P22DTE)		EPBMPN3-V019Z	93061	10	307,5
2.2 HDi 120	2.198	88	4	04.2006-	4HU(P22DTE)		EPBBPT4-A011Z	94601	20	300
2.2 HDi 130	2.198	96	4	07.2011-	4HH(P22DTE)	 ; Equip. Var. PUMAC	EPBMPN3-V019Z	93061	10	307,5
2.2 HDi 150	2.198	110	4	07.2011-	4HJ(P22DTE)		EPBMPN3-V019Z	93061	10	307,5
3.0 HDi 145	2.999	107	4	07.2010-	F30DTE(F1CE3481N)		EPBBPT4-V001Z	92565	11	307
3.0 HDi 155	2.999	115	4	07.2010-	F1CE0481D(F30DT)		EPBBPT4-V001Z	92565	11	307
3.0 HDi 160	2.999	116	4	09.2006-	F1CE0481D(F30DT)		EPBBPT4-V001Z	92565	11	307

JUMPY (U6U_, BS_, BT_, BY_, BZ_, BU_, BV_, BW_, BX_)

2.0 HDi 95	1.997	69	4	-06.2003	RHX(DW10BTED)		EPBBPN3-A003Z	91268	10	250
2.0 HDi 95	1.997	69	4	06.2003-	RHX(DW10BTED)		EPBBPN3-A006Z	91736	10	240
2.0 HDi 110	1.997	80	4	03.2000-10.2006	RHZ(DW10ATED)		EPBBPN3-A003Z	91268	10	250
2.0 HDi 110	1.997	80	4	-06.2003	RHW(DW10ATED4)	 ; RPO<09701	EPBBPN3-A003Z	91268	10	250
2.0 HDi 110	1.997	80	4	06.2003-	RHZ(DW10BTED+)		EPBBPN3-A006Z	91736	10	240
2.0 HDi 110	1.997	80	4	07.2003-	RHW(DW10ATED4)	 ; RPO>09702	EPBBPN3-A006Z	91736	10	240
2.0	1.997	100	4	04.2000-12.2006	RFN(EW10J4)		EPBMPN3-A007Z	96754	20	105
2.0 i 16V	1.997	102	4	03.2000-10.2006	RFN(EW10J4)		EPBMPN3-A007Z	96754	20	105

MAP



l kW
C
Y
I



Type-N°

Stock-N°

kPa from
kPa to

CITROËN

JUMPY (VF7)

1.6 HDi 90 16V	1.560	66	4	01.2007-	9HU(DV6UTED4)		EPBBPN3-A001Z	94263	10	240
1.6 HDi 90 8V	1.560	66	4	01.2007-	9HM(DV6UC)		EPBMBT4-A003Z	93024	12,9	316,5
2.0 HDi 95	1.997	72	4	07.2011-	AHY(DW10CE)		EPBMBT4-A003Z	93024	12,9	316,5
2.0 HDi 120	1.997	88	4	01.2007-	RHK(DW10UTED4)		EPBBPN3-A001Z	94263	10	240
2.0 HDi 125	1.997	94	4	07.2011-	AHZ(DW10CD)		EPBMBT4-A003Z	93024	12,9	316,5
2.0 HDi 140	1.997	100	4	01.2007-	RHR(DW10BTED4)		EPBBPN3-A001Z	94263	10	240
2.0 i	1.997	103	4	01.2007-	RFH(EW10A), RFJ(EW10A)		EPBMPT4-A001Z	93136	10	117
2.0 HDi 165	1.997	120	4	07.2010-	RHH(DW10CTED4)		EPBMBT4-A003Z	93024	12,9	316,5

NEMO (AA_)

1.3 HDi 75	1.248	55	4	10.2010-	FHZ(F13DTE5)		EPBBPT4-V001Z	92565	11	307
1.4 HDi	1.398	50	4	02.2008-	8HS(DV4TED)		EPBBPN3-A006Z	91736	10	240
1.4	1.360	54	4	02.2008-	KFV(TU3A)	; Position: Intake Manifold	EPBMPT4-A001Z	93136	10	117

SAXO (S0, S1, S3_)

1.1 X, SX	1.124	44	4	05.1996- 09.2003	HDZ(TU1M), HFX(TU1JP)		EPBMPT4-A001Z	93136	10	117
1.4 VTS	1.360	55	4	05.1996- 06.2003	KFW(TU3JP), KFX(TU3JP)		EPBMPT4-A001Z	93136	10	117
1.4 VTS	1.360	55	4	-12.1998	KFW(TU3JP), KFX(TU3JP)	; USA	EPBMPN3-A009Z	92952	20	100
1.6 VTL, VTR	1.587	65	4	-06.1998	NFZ(TU5JP)		EPBMPN3-A027Z	90915	20	105
1.6 VTL, VTR	1.587	65	4	07.1998- 12.1998	NFZ(TU5JP)		EPBMPN3-A009Z	92952	20	100
1.6	1.587	66	4	-06.1998	NFZ(TU5JP)		EPBMPN3-A027Z	90915	20	105
1.6	1.587	66	4	07.1998- 12.1998	NFZ(TU5JP)		EPBMPN3-A009Z	92952	20	100
1.6 VTS	1.587	72	4	09.2000- 09.2003	NFT(TU5JP)		EPBMPT4-A001Z	93136	10	117
1.6	1.587	74	4	02.2001- 04.2004	NFT(TU5JP)		EPBMPT4-A001Z	93136	10	117
1.6 VTS	1.587	87	4	-12.1998	NFX(TU5JP4)	; Euro 2	EPBMPN3-A009Z	92952	20	100
1.6 VTS	1.587	87	4	06.1996- 09.2003	NFX(TU5JP4)		EPBMPN3-A020Z	96725	20	117
1.6	1.587	88	4	-12.1998	NFX(TU5JP4)	; Euro 2	EPBMPN3-A009Z	92952	20	100
1.6	1.587	88	4	02.1996- 04.2004	NFX(TU5JP4)		EPBMPN3-A020Z	96725	20	117





XANTIA (X1_, X2_)

1.6 i	1.580	65	4	03.1993- 03.2001	BFZ(XU5JP)		EPBMPN3-A035Z	92810	20	100
1.8 i	1.761	66	4	04.1997- 04.2003	LFX(XU7JB)		EPBMPN3-A009Z	92952	20	100
1.8 i	1.761	74	4	03.1993- 01.1998	LFZ(XU7JP)		EPBMPN3-A027Z	90915	20	105
1.8 i	1.761	74	4	03.1993- 01.1998	LFZ		EPBMPN3-A002Z	96249	15	100
1.8 i 16V	1.761	81	4	06.1995- 04.2003	LFY(XU7JP4)		EPBMPN3-A009Z	92952	20	100
2.0 HDi 90	1.997	66	4	03.1999- 04.2003	RHY(DW10TD)		EPBBPN3-A003Z	91268	10	250
2.0 HDi 109	1.997	80	4	02.1999- 04.2003	RHZ(DW10ATED)		EPBBPN3-A003Z	91268	10	250
2.0 i	1.998	89	4	03.1993- 04.2003	RFX(XU10J2C)		EPBMPN3-A035Z	92810	20	100
2.0	1.998	95	4	03.1993- 05.1995	RFXXU10J2CZL3		EPBMPN3-A035Z	92810	20	100
2.0 i 16V	1.998	97	4	12.1996-	RFV(XU10J4R)		EPBMPN3-A009Z	92952	20	100



CITROËN

XANTIA (X1_, X2_)

2.1 Turbo D 12V	2.088	80	4	06.1995-02.1999	P8C(XUD11BTE)		EPBBPN3-A027Z	92471	10	200
3.0 V6 Break	2.946	140	6	-12.1998	XFZ(ES9J4)		EPBMPN3-A009Z	92952	20	100
3.0 V6 Break	2.946	140	6	12.1998-	XFZ(ES9J4)		EPBMPN3-A007Z	96754	20	105
3.0 i 24V	2.946	140	6	01.1997-04.2003	XFZ(ES9J4)		EPBMPN3-A009Z	92952	20	100



XM (Y3, Y4)

2.0 i	1.998	79	4	05.1989-04.1994	RDZ(XU10MZ), XU102C		EPBMPN3-A002Z	96249	15	100
2.0 i	1.998	89	4	05.1989-06.1994	RFZ		EPBMPN3-A002Z	96249	15	100
2.0 i	1.998	89	4	05.1993-	RFZ(XU10J2)		EPBMPN3-A027Z	90915	20	105
2.0 i 16V	1.998	97	4	11.1998-	RFV(XU10J4R)		EPBMPN3-A007Z	96754	20	105
2.0 i 16V	1.998	97	4	12.1996-11.1998	RFV(XU10J4R)		EPBMPN3-A009Z	92952	20	100
2.1 TD 12V	2.088	80	4	05.1994-10.2000	P8C(XUD11BTE)		EPBBPN3-A027Z	92471	10	200
2.5 TD	2.446	95	4	05.1994-10.2000	THY(DK5ATE)		EPBBPN3-A022Z	92949	20	250
3.0 V6	2.963	123	6	05.1989-06.1994	UFZ(ZPJZ)		EPBMPN3-A003Z	92477	15	102
3.0 V6	2.963	123	6	05.1994-10.2000	UFZ(ZPJZ)		EPBMPN3-A003Z	92477	15	102
3.0 V6	2.946	140	6	-12.1998	XFZ(ES9J4)		EPBMPN3-A009Z	92952	20	100
3.0 V6	2.946	140	6	12.1998-	XFZ(ES9J4)		EPBMPN3-A007Z	96754	20	105
3.0 V6 24V	2.963	147	6	07.1990-06.1994	SKZ(ZPJ4Z), UKZ(ZPJ4Z)		EPBMPN3-A003Z	92477	15	102
3.0 V6 24V	2.963	147	6	05.1994-10.2000	SKZ(ZPJ4Z), UKZ(ZPJ4Z)		EPBMPN3-A003Z	92477	15	102

XSARA (NO, N1, N2, ESTATE VAN)

1.4 i	1.360	55	4	04.1997-08.2005	KFW(TU3JP), KFX(TU3JP)		EPBMPT4-A001Z	93136	10	117
1.4 i	1.360	55	4	-11.1998	KFW(TU3JP), KFX(TU3JP)	 ; RPO<08056	EPBMPN3-A009Z	92952	20	100
1.4 LPG	1.360	55	4	-11.1998	KFW(TU3JP), KFX(TU3JP)	 ; RPO<08056	EPBMPN3-A009Z	92952	20	100
1.6 i	1.587	65	4	-05.1998	NFZ(TU5JP)	 ; RPO<07874	EPBMPN3-A027Z	90915	20	105
1.6 i	1.587	65	4	06.1998-01.1999	NFZ(TU5JP)	 ; RPO>07875; RPO<08119	EPBMPN3-A009Z	92952	20	100
1.6 16V	1.587	80	4	09.2000-08.2005	NFU(TU5JP4)		EPBMPT4-A001Z	93136	10	117
1.8 i	1.761	66	4	-11.1998	LFX(XU7JB)	 ; RPO<08007	EPBMPN3-A009Z	92952	20	100
1.8 i	1.761	74	4	02.1998-09.2000	LFZ(XU7JP)		EPBMPN3-A002Z	96249	15	100
1.8 i Aut.	1.761	74	4	04.1997-09.2000	LFZ(XU7JP)		EPBMPN3-A002Z	96249	15	100
1.8 i 16V	1.761	81	4	-11.1998	LFY(XU7JP4)	 ; RPO<08007	EPBMPN3-A009Z	92952	20	100
1.8 i 16V	1.761	81	4	04.1997-09.2000	LFY(XU7JP4)		EPBMPN3-A003Z	92477	15	102
2.0 HDi 109	1.997	80	4	05.2001-08.2005	RHZ(DW10ATED)		EPBBPN3-A001Z	94263	10	240
2.0 16V	1.998	97	4	-11.1998	RFV(XU10J4R)	 ; RPO<08056	EPBMPN3-A009Z	92952	20	100
2.0 16V	1.997	100	4	09.2000-08.2005	RFN(EW10J4)		EPBMPN3-A020Z	96725	20	117
2.0 i 16V	1.998	120	4	-11.1998	RFS(XU10J4RS)	 ; RPO<08056	EPBMPN3-A009Z	92952	20	100

XSARA PICASSO (N68)

1.6 HDi	1.560	66	4	09.2005-12.2011	9HX(DV6ATED4)	 ; Position: Suction Pipe	EPBBPN3-A001Z	94263	10	240
1.6	1.587	67	4	06.2002-08.2005	NFZ(TU5JP)	 ; Position: Suction Pipe	EPBMPN3-A007Z	96754	20	105

MAP



l kW
C
Y
I



Type-N°

Stock-N°

kPa from
kPa to

CITROËN

XSARA PICASSO (N68)

1.6	1.587	70	4	12.1999-12.2010	NFV(TU5JP)	; Position: Suction Pipe	EPBMPT4-A001Z	93136	10	117
1.6 16V	1.587	80	4	09.2005-12.2011	NFU(TU5JP4)		EPBMPT4-A001Z	93136	10	117
1.6 HDi	1.560	80	4	05.2004-12.2011	9HZ(DV6TED4)	; Position: Suction Pipe	EPBBPN3-A001Z	94263	10	240
1.8 16V	1.749	85	4	02.2000-08.2005	6FZ(EW7J4)		EPBMPN3-A020Z	96725	20	117
2.0 16V	1.997	100	4	01.2003-06.2012	RFN(EW10J4)		EPBMPN3-A020Z	96725	20	117

ZX (N2)

1.4 i	1.360	55	4	03.1991-10.1997	KFX(TU3JP)		EPBMPN3-A009Z	92952	20	100
1.4 i	1.360	55	4	03.1991-10.1997	KDX(TU3MZ), KDZ(TU3MZ), KFX(TU3JP)		EPBMPN3-A002Z	96249	15	100
1.6 i	1.580	65	4	03.1991-10.1997	BDY(XU5M), BFZ(XU5JP)		EPBMPN3-A002Z	96249	15	100
1.6	1.580	66	4	07.1994-10.1997	BDY(XU5M), BFZ(XU5JP)		EPBMPN3-A002Z	96249	15	100
1.8 i	1.761	74	4	07.1992-10.1997	LFZ(XU7JP)		EPBMPN3-A027Z	90915	20	105
1.8 i	1.761	74	4	07.1992-10.1997	LFZ		EPBMPN3-A002Z	96249	15	100
1.8	1.761	76	4	03.1991-10.1997	LFZ(XU7JP)		EPBMPN3-A027Z	90915	20	105
1.8	1.761	76	4	03.1991-10.1997	LFZ(XU7JP)		EPBMPN3-A002Z	96249	15	100
1.8 i 16V	1.761	81	4	01.1996-02.1998	LFY(XU7JP4)		EPBMPN3-A009Z	92952	20	100
1.8	1.761	82	4	04.1996-10.1997	LFY(XU7JP4)		EPBMPN3-A009Z	92952	20	100
2.0 i	1.998	89	4	07.1992-06.1997	RFX(XU10J2C)		EPBMPN3-A002Z	96249	15	100
2.0	1.998	90	4	07.1994-10.1997	RFX(XU10J2C)		EPBMPN3-A002Z	96249	15	100
2.0 i 16V	1.998	120	4	05.1996-06.1997	RFS(XU10J4RS)		EPBMPN3-A009Z	92952	20	100
2.0	1.998	122	4	09.1996-10.1997	RFS(XU10J4RS)		EPBMPN3-A009Z	92952	20	100

DACIA

DOKKER (KE_)

1.6	1.598	61	4	11.2012-	K7M812, K7M828	; Position: Intake Manifold	EPBMPN3-V001Z	90037	20	100
1.6 LPG	1.598	61	4	11.2013-	K7M812, K7M828	; Position: Intake Manifold	EPBMPN3-V001Z	90037	20	100

DUSTER (HS_)

1.5 dCi	1.461	63	4	04.2010-01.2018	K9K796, K9K830		EPBBPN3-V014Z	96895	20	250
1.5 dCi	1.461	66	4	10.2010-01.2018	K9K612, K9K884, K9K892		EPBBPN3-V007Z	97073	20	300
1.5 dCi 4x4	1.461	66	4	10.2010-01.2018	K9K884, K9K894		EPBBPN3-V007Z	97073	20	300
1.5 dCi	1.461	79	4	06.2010-01.2018	K9K896		EPBBPN3-V007Z	97073	20	300
1.5 dCi	1.461	80	4	09.2013-	K9K856, K9K858		EPBBPN3-V007Z	97073	20	300
1.5 dCi 4x4	1.461	80	4	09.2013-	K9K658, K9K856, K9K858, K9K898		EPBBPN3-V007Z	97073	20	300
1.5 dCi 4x4	1.461	81	4	10.2010-01.2018	K9K856, K9K858, K9K898		EPBBPN3-V007Z	97073	20	300
1.6 16V	1.598	77	4	04.2010-01.2018	K4M690, K4M696		EPBMPN3-V001Z	90037	20	100
1.6 16V LPG	1.598	77	4	04.2011-01.2018	K4M616, K4M642		EPBMPN3-V001Z	90037	20	100
1.6 16V 4x4	1.598	77	4	06.2010-01.2018	K4M606		EPBMPN3-V001Z	90037	20	100

DUSTER BOX

1.5 dCi	1.461	66	4	04.2011-	K9K884, K9K892		EPBBPN3-V007Z	97073	20	300
---------	-------	----	---	----------	----------------	--	---------------	-------	----	-----



MAP



l kW
C
Y
I



Type-N°

Stock-N°

kPa from

kPa to

DACIA

DUSTER BOX

1.5 dCi 4x4	1.461	66	4	04.2011-	K9K884, K9K892		EPBBPN3-V007Z	97073	20	300
1.5 dCi	1.461	80	4	04.2013-	K9K666	; Position: Air Filter Housing	EPBBPN3-V016Z	92713	50	350
1.5 dCi	1.461	80	4	09.2013-	K9K856		EPBBPN3-V007Z	97073	20	300
1.5 dCi 4x4	1.461	80	4	09.2013-	K9K658, K9K858		EPBBPN3-V007Z	97073	20	300

LODGY (JS_)

1.5 dCi	1.461	79	4	01.2013-	K9K846		EPBBPN3-V007Z	97073	20	300
1.5 dCi	1.461	80	4	06.2015-	K9K666, K9K846		EPBBPN3-V007Z	97073	20	300
1.5 dCi	1.461	81	4	03.2012-	K9K666, K9K846		EPBBPN3-V007Z	97073	20	300

LOGAN (LS_)

1.4	1.390	55	4	09.2004-	K7J710		EPBMPN3-V001Z	90037	20	100
1.5 dCi	1.461	48	4	09.2005-	K9K790		EPBMPN3-V001Z	90037	20	100
1.5 dCi	1.461	48	4	09.2005-	K9K790		EPBBPN3-V014Z	96895	20	250
1.5 dCi	1.461	50	4	01.2006-	K9K792		EPBMPN3-V001Z	90037	20	100
1.5 dCi	1.461	50	4	01.2006-	K9K792		EPBBPN3-V014Z	96895	20	250
1.5 dCi	1.461	55	4	05.2010-	K9K892		EPBBPN3-V007Z	97073	20	300
1.5 dCi	1.461	63	4	09.2007-	K9K796		EPBMPN3-V001Z	90037	20	100
1.5 dCi	1.461	63	4	09.2007-	K9K796		EPBBPN3-V014Z	96895	20	250
1.5 dCi	1.461	65	4	05.2010-	K9K892		EPBBPN3-V007Z	97073	20	300
1.6	1.598	64	4	09.2004-	K7M710		EPBMPN3-V001Z	90037	20	100
1.6 16V	1.598	77	4	02.2006-	K4M690, K4M694, K4M696, K4M697, K4M698		EPBMPN3-V001Z	90037	20	100

LOGAN EXPRESS (FS_)

1.4	1.390	55	4	03.2009-	K7J710		EPBMPN3-V001Z	90037	20	100
1.5 dCi	1.461	50	4	03.2009-	K9K792		EPBBPN3-V014Z	96895	20	250
1.5 dCi	1.461	55	4	05.2010-	K9K892		EPBBPN3-V007Z	97073	20	300
1.5 dCi	1.461	63	4	03.2009-	K9K796		EPBBPN3-V014Z	96895	20	250
1.5 dCi	1.461	65	4	05.2010-	K9K892		EPBBPN3-V007Z	97073	20	300
1.6 MPI 85	1.598	62	4	05.2010-	K7M800		EPBMPN3-V001Z	90037	20	100
1.6	1.598	64	4	03.2009-	K7M710		EPBMPN3-V001Z	90037	20	100

LOGAN MCV (KS_)

1.4	1.390	55	4	02.2007-	K7J710		EPBMPN3-V001Z	90037	20	100
1.5 dCi	1.461	50	4	02.2007-	K9K792		EPBMPN3-V001Z	90037	20	100
1.5 dCi	1.461	50	4	02.2007-	K9K792		EPBBPN3-V014Z	96895	20	250
1.5 dCi	1.461	55	4	05.2010-	K9K892		EPBBPN3-V007Z	97073	20	300
1.5 dCi	1.461	63	4	09.2007-	K9K796		EPBMPN3-V001Z	90037	20	100
1.5 dCi	1.461	63	4	09.2007-	K9K796		EPBBPN3-V014Z	96895	20	250
1.5 dCi	1.461	65	4	05.2010-	K9K892		EPBBPN3-V007Z	97073	20	300
1.6 MPI 85	1.598	62	4	05.2010-	K7M800		EPBMPN3-V001Z	90037	20	100



MAP

 kW
C
Y
I

Type-N°

Stock-N°

 kPa from
kPa to

DACIA
LOGAN MCV (KS_)

1.6	1.598	64	4	02.2007-	K7M710		EPBMPN3-V001Z	90037	20	100
1.6 16V	1.598	77	4	02.2007-	K4M690, K4M696, K4M697		EPBMPN3-V001Z	90037	20	100

LOGAN PICKUP (US_)

1.4	1.390	55	4	01.2009-	K7J710		EPBMPN3-V001Z	90037	20	100
1.5 dCi	1.461	50	4	03.2008-	K9K792		EPBBPN3-V014Z	96895	20	250
1.5 dCi	1.461	55	4	05.2010-	K9K892		EPBBPN3-V007Z	97073	20	300
1.5 dCi	1.461	63	4	03.2008-	K9K796		EPBBPN3-V014Z	96895	20	250
1.5 dCi	1.461	65	4	05.2010-	K9K892		EPBBPN3-V007Z	97073	20	300
1.6 MPI 85	1.598	62	4	05.2010-	K7M800		EPBMPN3-V001Z	90037	20	100
1.6	1.598	64	4	03.2008-	K7M710		EPBMPN3-V001Z	90037	20	100

SANDERO

1.4	1.390	55	4	06.2008-	K7J710		EPBMPN3-V001Z	90037	20	100
1.5 dCi	1.461	50	4	11.2008-	K9K792		EPBBPN3-V014Z	96895	20	250
1.5 dCi	1.461	55	4	05.2010-	K9K892		EPBBPN3-V007Z	97073	20	300
1.5 dCi	1.461	63	4	11.2008-	K9K796		EPBBPN3-V014Z	96895	20	250
1.5 dCi	1.461	65	4	05.2010-	K9K892		EPBBPN3-V007Z	97073	20	300
1.6	1.598	64	4	06.2008-	K7M710		EPBMPN3-V001Z	90037	20	100

DAEWOO
GENTRA SALOON

1.5	1.485	79	4	06.2013-	B15D2		EPBMPN3-V017Z	91253	10	120
-----	-------	----	---	----------	-------	--	---------------	-------	----	-----

KALOS (KLAS)

1.2	1.150	53	4	04.2003-	B12S1, B12S3, F12S3		EPBMPN3-V021Z	92226		
1.4 16V	1.399	69	4	04.2003-	F14D3		EPBMPN3-V021Z	92226		

LACETTI (KLAN)

1.4	1.399	70	4	02.2004-	F14D3		EPBMPN3-V021Z	92226		
-----	-------	----	---	----------	-------	--	---------------	-------	--	--

LANOS (KLAT)

1.3	1.349	55	4	05.1997-	L13		EPBMPN3-A003Z	92477	15	102
1.5	1.498	63	4	05.1997-	LX6		EPBMPN3-A003Z	92477	15	102
1.6 16V	1.598	78	4	05.1997-	L44		EPBMPN3-A003Z	92477	15	102

LEGANZA (KLAV)

2.0 16V	1.998	93	4	07.2000-04.2004	T20SED		EPBMPN3-V005Z	93871	20	100
2.0 16V	1.998	98	4	06.1997-12.2002	X20SED		EPBMPN3-V005Z	93871	20	100
2.0	1.998	133	4	01.2001-12.2002	T20SED		EPBMPN3-V005Z	93871	20	100
2.2 16V	2.198	100	4	04.1999-12.2002	T22SED		EPBMPN3-V005Z	93871	20	100

MATIZ (M100, M150)

0.8	796	38	3	09.1998-	F8CV		EPBMPN3-A003Z	92477	15	102
0.8	796	38	3	09.1998-	F8CV		EPBMPN3-V021Z	92226		
0.8	796	38	3	09.1998-	F8CV		EPBMPN3-V042Z	92659	15	102



MAP
 kW
C
Y
I

Type-N°

Stock-N°

kPa from

kPa to

DAEWOO**NUBIRA (J100, J150)**

1.6 16V	1.598	76	4	07.2000-	A16DMS		EPBMPN3-A003Z	92477	15	102
1.6 16V	1.598	78	4	05.1997-	A16DMS		EPBMPN3-A003Z	92477	15	102
2.0	1.998	81	4	06.1999- 07.2003	C20SED		EPBMPN3-V005Z	93871	20	100
2.0 16V	1.998	93	4	12.2000-	T20SED		EPBMPN3-V005Z	93871	20	100
2.0 16V	1.998	98	4	05.1997-	X20SED		EPBMPN3-V005Z	93871	20	100

REZZO (U100)

1.8	1.761	67	4	09.2000-	F18D2		EPBMPN3-V011Z	94242	20	115
1.8	1.761	72	4	09.2000-	A18DMS, F18S2		EPBMPN3-V011Z	94242	20	115
1.8	1.761	74	4	09.2000-	F18S2		EPBMPN3-V011Z	94242	20	115
2.0	1.998	89	4	09.2001- 12.2004	X20SED		EPBMPN3-V005Z	93871	20	100
2.0	1.998	89	4	09.2001- 12.2004	X20SED		EPBMPN3-V011Z	94242	20	115
2.0	1.998	94	4	09.2000-	T20SED		EPBMPN3-V005Z	93871	20	100
2.0	1.998	94	4	09.2000-	T20SED		EPBMPN3-V011Z	94242	20	115

TICO (KLY3)

0.8	796	38	3	01.1996- 12.2000	F8CV		EPBMPN3-V021Z	92226		
0.8	796	38	3	01.1996- 12.2000	F8CV		EPBMPN3-V042Z	92659	15	102

DAIHATSU**CHARADE**

1.33 16V	1.329	73	4	05.2011-	1NR-FE		EPBMPN3-V025Z	94855	10	138,7
----------	-------	----	---	----------	--------	--	---------------	-------	----	-------

COPEN (L880_, L881_)

0.7	659	47	4	11.2005-	JB-DET		EPBMPN3-V025Z	94855	10	138,7
0.7	659	50	4	09.2003- 12.2007	JB-DET		EPBMPN3-V025Z	94855	10	138,7

CUORE VII (L275_, L285_, L276_)

1.0	998	51	3	04.2007-	1KR-FE		EPBMPT4-A030Z	96501	10	130
1.0 LPG	998	51	3	09.2011- 12.2012	1KR-FE		EPBMPT4-A030Z	96501	10	130

MATERIA (M4_)

1.3	1.298	67	4	10.2006-	K3-VE		EPBMPN3-V025Z	94855	10	138,7
1.5 LPG	1.495	76	4	01.2010- 12.2011	3SZVE		EPBMPN3-V025Z	94855	10	138,7
1.5	1.495	76	4	10.2006-	3SZVE		EPBMPN3-V025Z	94855	10	138,7
1.5 ECO 4WD	1.495	76	4	10.2006-	3SZVE		EPBMPN3-V025Z	94855	10	138,7

SIRION (M3_)

1.0	998	51	3	01.2005- 06.2013	1KR-FE		EPBMPT4-A030Z	96501	10	130
1.0 LPG	998	51	3	01.2005- 06.2013	1KR-FE		EPBMPT4-A030Z	96501	10	130
1.3	1.298	64	4	01.2005-	K3-VE		EPBMPN3-V025Z	94855	10	138,7
1.3 4WD	1.298	64	4	04.2005-	K3-VE		EPBMPN3-V025Z	94855	10	138,7
1.3	1.298	67	4	03.2008-	K3-VE		EPBMPN3-V025Z	94855	10	138,7
1.3 4WD	1.298	67	4	03.2008-	K3-VE		EPBMPN3-V025Z	94855	10	138,7
1.5	1.495	76	4	03.2008-	3SZVE		EPBMPN3-V025Z	94855	10	138,7



MAP

 kW
C
Y
I

Type-N°

Stock-N°

 kPa from
kPa to

DAIHATSU
TERIOS (J2_) | BEGO

1.3 VVT-i LPG 4x4	1.298	63	4	01.2009-12.2009	K3-VE		EPBMPN3-V025Z	94855	10	138,7
1.3 VVT-i 4x4	1.298	63	4	11.2005-	K3-VE		EPBMPN3-V025Z	94855	10	138,7
1.5 VVT-i 4x4	1.495	75	4	09.2010-	3SZVE		EPBMPN3-V025Z	94855	10	138,7
1.5 VVT-i RWD	1.495	75	4	09.2010-	3SZVE		EPBMPN3-V025Z	94855	10	138,7
1.5 4x4	1.495	77	4	05.2006-	3SZVE		EPBMPN3-V025Z	94855	10	138,7
1.5 LPG 4x4	1.495	77	4	06.2009-	3SZVE		EPBMPN3-V025Z	94855	10	138,7
1.5 VVT-i RWD	1.495	77	4	11.2005-	3SZVE		EPBMPN3-V025Z	94855	10	138,7

DAIMLER
SUPER EIGHT (X350)

4.2	4.196	291	8	09.2005-12.2009	AJ8FT	; Chass.>H30568	EPBMPT4-A007Z	96755	10	120
4.2	4.196	291	8	09.2005-12.2009	AJ8FT	; Chass.<H30567	EPBMPT4-A007Z	96755	10	120

DODGE
CALIBER

2.2 CRD	2.143	120	4	07.2010-	ENE		EPBMPN3-A004Z	90833	10	120
---------	-------	-----	---	----------	-----	--	---------------	-------	----	-----

CARAVAN

2.5 TD	2.499	85	4	01.1995-03.2001	ENC		EPBBPT4-V012Z	96542	20	250
--------	-------	----	---	-----------------	-----	--	---------------	-------	----	-----

DS
DS 3

1.6 THP	1.598	120	4	07.2015-07.2019	5GZ(EP6FDT)		EPBBPN3-A024Z	91449	50	350
1.6 THP 165	1.598	121	4	07.2015-07.2019	5GZ(EP6FDT)		EPBBPN3-V030Z	94092	50	465
1.6 THP 208	1.598	153	4	09.2015-07.2019	5GR (EP6FDTX)		EPBBPN3-V030Z	94092	50	465

DS 4 / DS 4 CROSSBACK (NX_)

1.6 THP 150	1.598	110	4	10.2016-12.2018	5FE (EP6CDTMD)		EPBBPN3-A024Z	91449	50	350
1.6 THP 165	1.598	121	4	07.2015-12.2018	5GZ(EP6FDT)		EPBBPN3-V030Z	94092	50	465
1.6 THP 210	1.598	155	4	07.2015-12.2018	5GM(EP6FDTX)		EPBBPN3-V030Z	94092	50	465

DS 5

1.6 THP 210	1.598	155	4	04.2015-12.2018	5GM(EP6FDTX)		EPBBPN3-V030Z	94092	50	465
2.0 Hybrid4 4x4	1.997	120	4	04.2015-12.2018	RHC(DW10CTED4)	; Position: Suction Pipe	EPBMBT4-A003Z	93024	12,9	316,5

FIAT
500 (312_)

0.9	875	59	2	12.2013-	312A5.000		EPBBPN3-V007Z	97073	20	300
0.9	875	63	2	09.2009-	312A2.000		EPBBPT4-V001Z	92565	11	307
0.9	875	63	2	09.2009-	312A2.000		EPBBPN3-V007Z	97073	20	300
0.9	875	77	2	10.2013-	199B6.000		EPBBPN3-V007Z	97073	20	300
0.9	964	44	2	12.2013-	312A4.000, 312A6.000		EPBMPT4-V003Z	93266	10	118
0.9	964	48	2	09.2012-	312A4.000		EPBMPT4-V003Z	93266	10	118
1.2	1.242	51	4	07.2007-	169A4.000		EPBMPT4-V003Z	93266	10	118
1.2 LPG	1.242	51	4	12.2010-	169A4.000		EPBMPT4-V003Z	93266	10	118



MAP



l kW
C
Y
I



Type-N°

Stock-N°

kPa from

kPa to

FIAT

500 (312_)

1.3 D Multijet	1,248	55	4	10.2007-	169A1.000		EPBMBN3-V001Z	92099	20	256
1.3 D Multijet	1,248	70	4	09.2009-	199B1.000, 312B1.000		EPBBPT4-V001Z	92565	11	307

500L (351_, 352_)

0.9 Natural Power	875	63	2	03.2013-	312A2.000		EPBBPN3-V007Z	97073	20	300
0.9	875	77	2	09.2012-	199B6.000		EPBBPN3-V007Z	97073	20	300
1.4	1,368	70	4	09.2012-	843A1.000	; Position: Intake Manifold	EPBMPT4-V028Z	93902	11,2	250
1.4	1,368	70	4	09.2012-	843A1.000		EPBMPT4-V003Z	93266	10	118
1.4 LPG	1,368	88	4	02.2014-	940B7.000		EPBBPN3-V007Z	97073	20	300
1.4	1,368	88	4	10.2013-	940B7.000		EPBMPT4-V028Z	93902	11,2	250
1.4	1,368	88	4	10.2013-	940B7.000		EPBBPN3-V007Z	97073	20	300

BRAVA (182_)

1.2 16V 80	1,242	59	4	10.2000- 10.2001	188A5.000		EPBMPT4-V003Z	93266	10	118
1.2 16V 80	1,242	60	4	12.1998- 12.2002	182B2.000		EPBMPT4-V032Z	96108		
1.6 16V	1,581	66	4	01.1999-	182A6.000		EPBMPT4-V012Z	91940	20	100
1.6 16V	1,581	66	4	10.1995- 10.2001	182A6.000		EPBMPN3-A002Z	96249	15	100
1.6 16V	1,581	76	4	01.1999-	182A4.000		EPBMPT4-V012Z	91940	20	100
1.6 16V	1,581	76	4	02.1996- 10.2001	182A4.000		EPBMPN3-A002Z	96249	15	100
1.9 JTD	1,910	74	4	09.2000- 10.2001	182B9.000	; Engine No.<2705194	EPBBPN3-V034Z	96381	20	250
1.9 JTD	1,910	74	4	09.2000- 10.2001	182B9.000		EPBMBN3-V001Z	92099	20	256
1.9 JTD 105	1,910	77	4	12.1998- 10.2001	182B4.000		EPBBPN3-V034Z	96381	20	250

BRAVO I (182_)

1.2 16V 80	1,242	59	4	10.2000- 10.2001	188A5.000		EPBMPT4-V003Z	93266	10	118
1.2 16V 80	1,242	60	4	12.1998- 10.2000	182B2.000		EPBMPT4-V032Z	96108		
1.6 16V	1,581	66	4	10.1995- 10.2001	182A6.000		EPBMPN3-A002Z	96249	15	100
1.6 16V	1,581	76	4	01.1999-	182A4.000		EPBMPT4-V012Z	91940	20	100
1.6 16V	1,581	76	4	03.1996- 10.2001	182A4.000		EPBMPN3-A002Z	96249	15	100
1.6	1,596	76	4	09.2000- 10.2001	182B6.000		EPBMPT4-V012Z	91940	20	100
1.9 JTD	1,910	74	4	09.2000- 10.2001	182B9.000	; Engine No.<2705194	EPBBPN3-V034Z	96381	20	250
1.9 JTD	1,910	74	4	09.2000- 10.2001	182B9.000		EPBMBN3-V001Z	92099	20	256
1.9 JTD 105	1,910	77	4	12.1998- 10.2001	182B4.000		EPBBPN3-V034Z	96381	20	250

BRAVO II (198_)

1.4	1,368	66	4	04.2007- 12.2014	192B2.000		EPBMPT4-V003Z	93266	10	118
1.4 LPG	1,368	66	4	12.2008- 12.2014	192B2.000		EPBMPT4-V003Z	93266	10	118
1.4 T-Jet	1,368	88	4	10.2007- 12.2014	198A4.000		EPBMBN3-V001Z	92099	20	256
1.4 16V	1,368	103	4	04.2010- 12.2014	198A7.000		EPBBPT4-V001Z	92565	11	307
1.4 T-Jet	1,368	110	4	09.2007- 12.2014	198A1.000	; Position: Suction Pipe	EPBBPT4-V010Z	91257	20	250
1.4 T-Jet	1,368	110	4	09.2007- 12.2014	198A1.000		EPBMBN3-V001Z	92099	20	256



MAP

 l kW
C
Y
I

Type-N°

Stock-N°

kPa from

kPa to

FIAT
BRAVO II (198_)

1.6 D Multijet	1.598	77	4	09.2007-12.2014	198A3.000, 844A3.000		EPBBPT4-V001Z	92565	11	307
1.6 D Multijet	1.598	88	4	03.2008-12.2014	198A2.000		EPBBPT4-V001Z	92565	11	307
1.9 D Multijet	1.910	88	4	04.2007-12.2014	192A8.000		EPBBPT4-V001Z	92565	11	307
1.9 D Multijet	1.910	110	4	04.2007-12.2014	937A5.000		EPBBPT4-V001Z	92565	11	307
2.0 D Multijet	1.956	120	4	09.2008-12.2014	198A8.000, 844A2.000		EPBBPT4-V001Z	92565	11	307
2.0 D Multijet	1.956	121	4	09.2008-12.2014	198A5.000		EPBBPT4-V001Z	92565	11	307

CINQUECENTO (170_)

0.9 i.e. S	899	29	4	07.1991-07.1999	1170A1.000, 1170A1.046		EPBMPN3-A002Z	96249	15	100
0.9 i.e.	903	30	4	07.1991-09.1994	170A1.046		EPBMPN3-A002Z	96249	15	100
1.1 Sporting	1.108	40	4	10.1994-01.1998	176B2.000		EPBMPN3-A002Z	96249	15	100

COUPE (175_)

2.0 16V	1.995	102	4	11.1993-08.1996	836A3.000		EPBMPN3-A002Z	96249	15	100
2.0 16V Turbo	1.995	140	4	11.1993-08.1996	175A1.000		EPBMPN3-A043Z	92940	20	250

CROMA (154_)

1900 Turbo D i.d.	1.929	69	4	11.1992-12.1996	154D1.000		EPBMPN3-A002Z	96249	15	100
2000 i.e.	1.995	88	4	03.1987-09.1992	154C3.000, 834B.000		EPBMPN3-A002Z	96249	15	100

CROMA (194_)

1.9 D Multijet	1.910	85	4	06.2005-	939A7.000		EPBBPT4-V001Z	92565	11	307
1.9 D Multijet	1.910	88	4	06.2005-12.2011	939A1.000		EPBBPT4-V001Z	92565	11	307
1.9 D Multijet	1.910	100	4	12.2005-	939A8.000		EPBBPT4-V001Z	92565	11	307
1.9 D Multijet	1.910	110	4	06.2005-12.2011	939A2.000		EPBBPT4-V001Z	92565	11	307
2.2 16V	2.198	108	4	06.2005-	194A1.000	; Position: Suction Pipe	EPBMPN3-V005Z	93871	20	100
2.4 D Multijet	2.387	147	5	06.2005-	939A3.000		EPBBPT4-V001Z	92565	11	307

DOBLO (119_, 223_)

1.2	1.242	48	4	03.2001-	223A5.000		EPBMPT4-V012Z	91940	20	100
1.3 D Multijet	1.248	55	4	10.2005-01.2010	199A2.000		EPBMBN3-V001Z	92099	20	256
1.3 D Multijet	1.248	55	4	10.2005-01.2010	199A2.000		EPBBPT4-V001Z	92565	11	307
1.3 D Multijet	1.248	62	4	10.2005-	223A9.000		EPBMBN3-V001Z	92099	20	256
1.3 D Multijet	1.248	62	4	10.2005-	223A9.000		EPBBPT4-V001Z	92565	11	307
1.4	1.368	57	4	10.2005-	350A1.000	; Position: Upper	EPBMPN3-V022Z	91412	10	117
1.4	1.368	57	4	10.2005-	350A1.000		EPBMPT4-V003Z	93266	10	118
1.6 Natural Power	1.596	76	4	09.2002-	182B6.000		EPBMPT4-V012Z	91940	20	100
1.6 16V	1.596	76	4	10.2001-	182B6.000		EPBMPT4-V012Z	91940	20	100
1.9 JTD	1.910	74	4	10.2001-	182B9.000		EPBMBN3-V001Z	92099	20	256
1.9 JTD	1.910	74	4	10.2001-	182B9.000, 223B2.000		EPBBPT4-V001Z	92565	11	307
1.9 JTD	1.910	77	4	07.2003-	223A.7000		EPBMBN3-V001Z	92099	20	256
1.9 JTD	1.910	77	4	07.2003-	223A7.000, 223B1.000		EPBBPT4-V001Z	92565	11	307
1.9 JTD Multijet	1.910	88	4	12.2006-	186A9.000		EPBBPT4-V001Z	92565	11	307



MAP



l kW
C
Y
I



Type-N°

Stock-N°

kPa from

kPa to

FIAT

DOBLO (119_, 223_)

1.9 D Multijet	1.910	88	4	10.2005-	186A9.000		EPBBPT4-V001Z	92565	11	307
----------------	-------	----	---	----------	-----------	--	---------------	-------	----	-----

DOBLO (263_)

1.3 D Multijet	1.248	66	4	02.2010-	199A3.000, 263A2.000		EPBBPT4-V001Z	92565	11	307
1.4	1.368	70	4	02.2010-	843A1.000		EPBMP4-V003Z	93266	10	118
1.4 Natural Power	1.368	88	4	02.2010-	198A4.000	; Position: Intake Manifold; Euro5	EPBBPT4-V010Z	91257	20	250
1.4 Natural Power	1.368	88	4	02.2010-	198A4.000		EPBMBN3-V001Z	92099	20	256
1.4 Natural Power	1.368	88	4	02.2010-	198A4.000		EPBBPN3-V007Z	97073	20	300
1.4	1.368	88	4	10.2011-	198A4.000		EPBMBN3-V001Z	92099	20	256
1.4	1.368	88	4	10.2011-	198A4.000		EPBBPN3-V007Z	97073	20	300
1.4	1.368	88	4	10.2011-	198A4.000	; Euro 5	EPBBPT4-V010Z	91257	20	250
1.4	1.368	88	4	10.2011-	198A4.000		EPBMP4-V028Z	93902	11,2	250
1.6 D Multijet	1.598	66	4	02.2010-	263A4.000, 263A5.000		EPBBPT4-V001Z	92565	11	307
1.6 D Multijet	1.598	74	4	02.2010-	263A3.000, 263A9.000		EPBBPT4-V001Z	92565	11	307
1.6 D Multijet	1.598	77	4	01.2010-	198A3.000, 263A8.000		EPBBPT4-V001Z	92565	11	307
2.0 D Multijet	1.956	99	4	01.2010-	263A1.000		EPBBPT4-V001Z	92565	11	307

DUCATO (230_)

2.0 JTD	1.997	62	4	07.2001- 04.2002	RHV(DW10)		EPBMPN3-A002Z	96249	15	100
2.0	1.998	80	4	03.1994- 04.2002	RFW		EPBMPN3-A002Z	96249	15	100
2.0 4x4	1.998	80	4	11.1994- 04.2002	RFW		EPBMPN3-A002Z	96249	15	100
2.8 D	2.800	64	4	02.1998- 04.2002	8140.63		EPBMPN3-A002Z	96249	15	100
2.8 D 4x4	2.800	64	4	08.1998- 04.2002	8140.63		EPBMPN3-A002Z	96249	15	100
2.8 iDTD 4x4	2.799	90	4	05.1998- 09.2001	8140.43		EPBMPN3-A002Z	96249	15	100
2.8 TDI 4x4	2.800	90	4	06.1999- 04.2002	8140.43		EPBMPN3-A002Z	96249	15	100
2.8 TDI	2.800	90	4	10.1997- 04.2002	8140.43		EPBMPN3-A002Z	96249	15	100
2.8 JTD	2.798	94	4	-03.2002	8140.43S		EPBBPT4-V012Z	96542	20	250
2.8 JTD 4x4	2.798	94	4	-03.2002	8140.43S		EPBBPT4-V012Z	96542	20	250
2.8 JTD	2.798	94	4	11.2000- 04.2002	8140.43S		EPBMPN3-A002Z	96249	15	100
2.8 JTD 4x4	2.798	94	4	11.2000- 04.2002	8140.43S		EPBMPN3-A002Z	96249	15	100

DUCATO (244_)

2.0	1.998	81	4	04.2002-	RFL(XU10J2U)		EPBMPN3-A002Z	96249	15	100
2.0 4x4	1.998	81	4	05.2002- 07.2006	RFL(XU10J2U)		EPBMPN3-A002Z	96249	15	100
2.0 Bipower	1.998	81	4	11.2002-	RFL(XU10J2U)		EPBMPN3-A002Z	96249	15	100
2.3 JTD	2.286	81	4	04.2002-	F1AE0481C		EPBBPT4-V005Z	93700	20	250
2.8 JTD	2.798	94	4	04.2002-	8140.43S		EPBBPT4-V005Z	93700	20	250
2.8 JTD 4x4	2.798	94	4	07.2002-	8140.43S	; Chass.>5971211	EPBMPN3-A002Z	96249	15	100
2.8 JTD 4x4	2.798	94	4	07.2002-	8140.43S		EPBBPT4-V005Z	93700	20	250
2.8 JTD Power	2.800	107	4	05.2004-	8140.43N		EPBBPT4-V005Z	93700	20	250



MAP



l kW
C
Y
I



Type-N°

Stock-N°

kPa from
kPa to

FIAT

DUCATO (250_, 290_)

115 Multijet 2.0 D	1.956	85	4	06.2011-	250A1.000, 250A2.000		EPBBPT4-V001Z	92565	11	307
100 Multijet 2.2 D	2.198	74	4	07.2006-	4HV(P22DTE)		EPBBPT4-A011Z	94601	20	300
110 Multijet 2.3 D	2.287	83	4	10.2011-	F1AE3481G		EPBBPT4-V001Z	92565	11	307
120 Multijet 2.3 D 4x4	2.287	88	4	03.2010-	F1AE0481D		EPBBPT4-V001Z	92565	11	307
120 Multijet 2.3 D	2.287	88	4	07.2006-	F1AE0481D, F1AGL4114, FPT		EPBBPT4-V001Z	92565	11	307
130 Multijet 2.3 D	2.287	96	4	07.2006-	F1AE0481N, F1A- E3481D, F1AGL411D		EPBBPT4-V001Z	92565	11	307
150 Multijet 2.3 D	2.287	109	4	06.2011-	F1AE3481E		EPBBPT4-V001Z	92565	11	307
140 Natural Power	2.999	100	4	04.2009-	F1CE0441A	; Position: Intake Manifold	EPBBPT4-V010Z	91257	20	250
140 Natural Power	2.999	100	4	04.2009-	F1CFA401A		EPBBPT4-V010Z	91257	20	250
140 Natural Power	2.999	100	4	04.2009-	F1CE0441A	; Position: Air Filter Housing	EPBMPT4-V012Z	91940	20	100
140 Natural Power	2.999	100	4	04.2009-	F1CFA401A		EPBMPT4-V012Z	91940	20	100
150 Multijet 3.0 D	2.999	107	4	04.2010-	F1CE3481N		EPBBPT4-V001Z	92565	11	307
160 Multijet 3.0 D	2.999	115	4	07.2006- 12.2011	F1CE3481M		EPBBPT4-V001Z	92565	11	307
160 Multijet 3.0 D	2.999	116	4	07.2006-	F1CE0481D, F1CE3481M		EPBBPT4-V001Z	92565	11	307
180 Multijet 3.0 D	2.999	130	4	06.2011-	F1CE3481E		EPBBPT4-V001Z	92565	11	307

FIORINO BOX BODY/ESTATE (225_)

1.3 D Multijet	1.248	55	4	11.2007-	199A2.000		EPBMBN3-V001Z	92099	20	256
1.3 D Multijet	1.248	55	4	11.2007-	199A2.000, 199A9.000		EPBBPT4-V001Z	92565	11	307
1.3 D Multijet	1.248	70	4	07.2009-	199B1.000, 330A1.000		EPBMBN3-V001Z	92099	20	256
1.3 D Multijet	1.248	70	4	07.2009-	199B1.000, 330A1.000		EPBBPT4-V001Z	92565	11	307
1.4	1.360	54	4	11.2007-	KFT, KfV		EPBMPT4-A001Z	93136	10	117
1.4	1.368	57	4	10.2009-	350A1.000		EPBMPT4-V003Z	93266	10	118
1.4 Natural Power	1.368	57	4	06.2008-	350A1.000		EPBMPT4-V003Z	93266	10	118

FREEMONT (345_)

2.0 JTD	1.956	100	4	08.2011-	939B5.000		EPBBPT4-V001Z	92565	11	307
2.0 JTD	1.956	103	4	08.2011-	939B5.000, 940A5.000		EPBBPT4-V001Z	92565	11	307
2.0 JTD 4x4	1.956	120	4	08.2011-	939B5.000		EPBBPT4-V001Z	92565	11	307
2.0 JTD	1.956	120	4	08.2011-	939B5.000		EPBBPT4-V001Z	92565	11	307
2.0 JTD	1.956	125	4	08.2011-	939B5.000, 940A5.000		EPBBPT4-V001Z	92565	11	307
2.0 JTD 4x4	1.956	125	4	08.2011-	939B5.000, 940A5.000		EPBBPT4-V001Z	92565	11	307

GRANDE PUNTO (199_)

1.2	1.242	48	4	10.2005-	199A4.000		EPBBPT4-V001Z	92565	11	307
1.2	1.242	48	4	10.2005-	199A4.000		EPBMPT4-V003Z	93266	10	118
1.2	1.242	51	4	09.2010-	169A4.000		EPBMPT4-V003Z	93266	10	118
1.3 D Multijet	1.248	55	4	10.2005-	199A2.000		EPBMBN3-V001Z	92099	20	256
1.3 D Multijet	1.248	55	4	10.2005-	199A2.000		EPBBPT4-V001Z	92565	11	307
1.3 D Multijet	1.248	62	4	04.2010-	223A9.000		EPBMBN3-V001Z	92099	20	256



MAP



l kW
C
Y
I



Type-N°

Stock-N°

kPa from

kPa to

FIAT

GRANDE PUNTO (199_)

1.3 D Multijet	1.248	66	4	10.2005-12.2010	199A3.000		EPBBPT4-V001Z	92565	11	307
1.4	1.368	55	4	10.2005-07.2007	199A7.000	; Number of Poles: 3	EPBMPN3-V022Z	91412	10	117
1.4	1.368	55	4	10.2005-07.2007	199A7.000		EPBMPT4-V003Z	93266	10	118
1.4	1.368	57	4	06.2005-12.2015	350A1.000	;	EPBMPN3-V022Z	91412	10	117
1.4	1.368	57	4	06.2005-12.2015	350A1.000		EPBBPT4-V001Z	92565	11	307
1.4	1.368	57	4	06.2005-12.2015	350A1.000		EPBMPT4-V003Z	93266	10	118
1.4 Natural Power	1.368	57	4	07.2008-	350A1.000	; Number of Poles: 3	EPBMPN3-V022Z	91412	10	117
1.4 Natural Power	1.368	57	4	07.2008-	350A1.000		EPBMPT4-V003Z	93266	10	118
1.4 LPG	1.368	57	4	12.2008-	350A1.000	;	EPBMPN3-V022Z	91412	10	117
1.4 LPG	1.368	57	4	12.2008-	350A1.000		EPBMPT4-V003Z	93266	10	118
1.4 LPG	1.368	57	4	03.2009-12.2012	350A1.000		EPBMPN3-V022Z	91412	10	117
1.4 16V	1.368	70	4	10.2005-08.2011	199A6.000	; Number of Poles: 3	EPBMPN3-V022Z	91412	10	117
1.4 16V	1.368	70	4	10.2005-08.2011	199A6.000		EPBBPT4-V001Z	92565	11	307
1.4 T-Jet	1.368	88	4	09.2007-	198A4.000	; Position: Suction Pipe	EPBBPT4-V010Z	91257	20	250
1.4 T-Jet	1.368	88	4	09.2007-	198A4.000		EPBMBN3-V001Z	92099	20	256
1.4 T-Jet	1.368	88	4	09.2007-	198A4.000		EPBBPT4-V001Z	92565	11	307
1.6 D Multijet	1.598	88	4	07.2008-	955A3.000		EPBMBN3-V001Z	92099	20	256
1.9 D Multijet	1.910	85	4	06.2006-12.2009	939A7.000		EPBBPT4-V001Z	92565	11	307
1.9 D Multijet	1.910	88	4	10.2005-	939A1.000		EPBBPT4-V001Z	92565	11	307
1.9 D Multijet	1.910	96	4	10.2005-	199A5.000		EPBBPT4-V001Z	92565	11	307

IDEA (350_)

1.2 16V	1.242	59	4	01.2004-	188A5.000		EPBMPT4-V003Z	93266	10	118
1.3 D Multijet	1.248	51	4	01.2004-	188A9.000		EPBMBN3-V001Z	92099	20	256
1.3 D Multijet	1.248	66	4	10.2005-	199A3.000		EPBBPT4-V001Z	92565	11	307
1.4 LPG	1.368	57	4	03.2009-	350A1.000		EPBMPN3-V022Z	91412	10	117
1.4 LPG	1.368	57	4	03.2009-	350A1.000		EPBMPT4-V003Z	93266	10	118
1.4	1.368	57	4	10.2005-	350A1.000		EPBMPN3-V022Z	91412	10	117
1.4	1.368	57	4	10.2005-	350A1.000		EPBMPT4-V003Z	93266	10	118
1.4	1.368	66	4	12.2003-	192B2.000	; Number of Poles: 3; Position: Suction Pipe	EPBMPN3-V022Z	91412	10	117
1.4	1.368	66	4	12.2003-	192B2.000		EPBMPT4-V003Z	93266	10	118
1.4 16V	1.368	70	4	01.2004-	843A1.000		EPBMPT4-V003Z	93266	10	118
1.6 D Multijet	1.598	88	4	05.2008-	350A2.000		EPBBPT4-V001Z	92565	11	307
1.9 JTD	1.910	74	4	01.2004-	188B2.000		EPBBPT4-V001Z	92565	11	307

LINEA (323_, 110_)

1.3 D Multijet	1.248	66	4	06.2007-	199A3.000		EPBBPT4-V001Z	92565	11	307
1.4	1.368	57	4	06.2007-	350A1.000	; Position: Upper	EPBMPN3-V022Z	91412	10	117
1.4	1.368	57	4	06.2007-	350A1.000		EPBMPT4-V003Z	93266	10	118



MAP



l kW
C
Y
I



Type-N°

Stock-N°

kPa from

kPa to

FIAT

LINEA (323_, 110_)

1.4 T-Jet	1.368	88	4	05.2007-	198A4.000		EPBMBN3-V001Z	92099	20	256
1.4 T-Jet	1.368	88	4	05.2007-	198A4.000, 198A4.000	; Position: Intake Manifold	EPBBPT4-V010Z	91257	20	250
1.6 D Multijet	1.598	77	4	06.2009-	198A3.000		EPBBPT4-V001Z	92565	11	307
1.6	1.598	81	4	10.2011-	310A5.011		EPBBPT4-V001Z	92565	11	307

MAREA (185_)

1.2 16V	1.242	60	4	10.1998- 05.2002	182B2.000		EPBMPT4-V032Z	96108		
1.6	1.581	68	4	03.1999- 08.2000	185A3.000		EPBMPT4-V012Z	91940	20	100
1.6 SX	1.581	72	4	09.2000- 08.2002	182B5.098		EPBMPN3-A002Z	96249	15	100
1.6 100 16V	1.581	76	4	01.1999-	182A4.000		EPBMPT4-V012Z	91940	20	100
1.6 100 16V	1.581	76	4	09.1996- 05.2002	182A4.000		EPBMPN3-A002Z	96249	15	100
1.6	1.596	76	4	09.2000- 08.2002	182B6.000		EPBMPT4-V012Z	91940	20	100
1.6	1.596	76	4	09.2000- 08.2002	182B6.000		EPBMPN3-A002Z	96249	15	100
1.9 TD 100	1.910	74	4	09.1996- 06.2003	182B9.000		EPBMBN3-V001Z	92099	20	256
1.9 JTD 105	1.910	77	4	12.1998- 12.2002	182B4.000		EPBBPN3-V034Z	96381	20	250
1.9 JTD 110	1.910	81	4	-07.2001	186A6.000		EPBBPN3-V034Z	96381	20	250
1.9 JTD 110	1.910	81	4	07.2001-	186A6.000		EPBMBN3-V001Z	92099	20	256
2.4 JTD 130	2.387	96	5	04.1999- 05.2002	185A6.000		EPBBPN3-V034Z	96381	20	250

MULTIPLA (186_)

1.6	1.596	68	4	05.2004- 08.2005	182B6.000		EPBMPT4-V012Z	91940	20	100
1.6 16V	1.596	70	4	04.2002- 06.2010	182B6.000		EPBMPT4-V012Z	91940	20	100
1.6 16V Blupower	1.581	70	4	04.1999- 06.2010	186A3.000		EPBMPT4-V012Z	91940	20	100
1.6	1.596	76	4	09.2000- 06.2010	182B6.000		EPBMPT4-V012Z	91940	20	100
1.6 100 16V	1.581	76	4	04.1999- 06.2010	182A4.000		EPBMPT4-V012Z	91940	20	100
1.6 16V Bipower	1.581	76	4	04.1999- 06.2010	186A4.000		EPBMPT4-V012Z	91940	20	100
1.6 16V Bipower	1.596	76	4	10.2001- 06.2010	182B6.000		EPBMPT4-V012Z	91940	20	100
1.6 16V GPL	1.596	76	4	10.2001- 06.2010	182B6.000		EPBMPT4-V012Z	91940	20	100
1.9 JTD 105	1.910	77	4	04.1999- 06.2010	182B4.000		EPBMBN3-V001Z	92099	20	256
1.9 JTD 110	1.910	81	4	-07.2001	186A6.000		EPBBPN3-V034Z	96381	20	250
1.9 JTD 110	1.910	81	4	07.2001-	186A6.000		EPBMBN3-V001Z	92099	20	256
1.9 JTD 115	1.910	85	4	07.2002- 06.2010	186A8.000		EPBMBN3-V001Z	92099	20	256
1.9 JTD 115	1.910	85	4	07.2002- 06.2010	186A8.000		EPBBPT4-V001Z	92565	11	307
1.9 JTD	1.910	88	4	04.2002- 06.2010	186A9.000		EPBBPT4-V001Z	92565	11	307

PALIO (178_)

1.0	994	45	4	04.1996- 10.2003	178A1.000		EPBMPT4-V012Z	91940	20	100
1.0	994	45	4	04.1996- 10.2003	178A1.000, 178A3.011		EPBMPN3-A002Z	96249	15	100
1.0	994	56	4	04.1996- 10.2003	178A1.000		EPBMPT4-V012Z	91940	20	100
1.2	1.242	44	4	07.1997- 08.2002	178B7.045, 178C4.066, 188A4.000		EPBMPN3-A002Z	96249	15	100



MAPkW
Y
I

Type-N°

Stock-N°

kPa from

kPa to

FIAT**PALIO (178_)**

1.2	1.242	44	4	07.1997-10.2004	178C4.066, 188A4.000		EPBMPT4-V012Z	91940	20	100
1.2	1.242	50	4	06.1999-10.2000	178E2.000		EPBMPN3-A002Z	96249	15	100
1.2	1.242	54	4	06.1998-	176A8.000, 178E2.000		EPBMPN3-A002Z	96249	15	100
1.2	1.242	54	4	04.1996-02.2001	178B5.000		EPBMPN3-A002Z	96249	15	100
1.2	1.242	59	4	09.2001-	188A5.000		EPBMPT4-V003Z	93266	10	118
1.4	1.372	51	4	04.1996-10.2002	178B2.000		EPBMPN3-A002Z	96249	15	100
1.4 Cat	1.372	51	4	04.1996-08.2001	178B2.016		EPBMPN3-A002Z	96249	15	100
1.4	1.368	63	4	10.2002-10.2004	350A1.000	; Position: Upper	EPBMPN3-V022Z	91412	10	117
1.4	1.368	70	4	06.2003-	834A1.000	; Number of Poles: 3	EPBMPN3-V022Z	91412	10	117
1.5	1.461	62	4	02.2002-	178E5.022		EPBMPT4-V012Z	91940	20	100
1.6 16V	1.581	68	4	07.1997-10.2003	178D2.011	; Number of Poles: 4	EPBMPT4-V012Z	91940	20	100
1.6 16V	1.581	74	4	04.1996-10.2002	178B3.000		EPBMPT4-V012Z	91940	20	100
1.6 16V	1.581	74	4	04.1996-10.2002	178B3.000		EPBMPN3-A002Z	96249	15	100
1.6 16V	1.596	76	4	02.2001-01.2012	182B6.000	; Type: 178DYC1A; Type: 178DY-C1AAP	EPBMPT4-V012Z	91940	20	100
1.6 16V	1.596	76	4	02.2001-01.2012	182B6.000		EPBMPN3-A002Z	96249	15	100
1.9 JTD	1.910	59	4	09.2001-	188A2.000		EPBMBN3-V001Z	92099	20	256

PANDA (141_)

750	770	25	4	01.1986-10.2003	156A4.000		EPBBPT4-V002Z	95912	20	300
900	899	29	4	04.1992-12.1996	1170A1.046		EPBMPN3-A002Z	96249	15	100
1000 i.e	999	33	4	08.1992-02.2004	156A2.246		EPBMPN3-A002Z	96249	15	100
1000 i.e. Cat	999	33	4	10.1987-08.1998	141C2.000, 156A2.246		EPBMPN3-A002Z	96249	15	100
1000 4x4	999	33	4	05.1986-12.1994	141C2.000, 156A2.246		EPBMPN3-A002Z	96249	15	100
1100	1.108	37	4	05.1991-12.1999	156C.046		EPBMPN3-A002Z	96249	15	100
1100 Trekking 4x4	1.108	37	4	10.1991-07.2004	156C.046		EPBMPN3-A002Z	96249	15	100
1100	1.108	40	4	02.1995-09.2003	187A1.000		EPBMPT4-V012Z	91940	20	100
1100	1.108	40	4	02.1995-09.2003	176B2.000, 187A1.000		EPBMPN3-A002Z	96249	15	100
1100 4x4	1.108	40	4	02.1995-07.2004	176B2.000		EPBMPN3-A002Z	96249	15	100

PANDA (169_)

1.1 (169.AXA1A)	1.108	40	4	09.2003-	187A1.000		EPBMPT4-V003Z	93266	10	118
1.2	1.242	44	4	09.2003-	188A4.000		EPBMPT4-V003Z	93266	10	118
1.2 4x4	1.242	44	4	10.2004-	188A4.000		EPBMPT4-V003Z	93266	10	118
1.2 LPG	1.242	44	4	-12.2012	188A4.000		EPBMPT4-V003Z	93266	10	118
1.2 Natural Power	1.242	44	4	01.2007-12.2011	188A4.000		EPBMPT4-V012Z	91940	20	100
1.2	1.242	51	4	03.2010-08.2013	169A4.000		EPBMPT4-V003Z	93266	10	118
1.2 4x4	1.242	51	4	04.2010-08.2013	169A4.000		EPBMPT4-V003Z	93266	10	118
1.2 LPG	1.242	51	4	-12.2012	169A4.000		EPBMPT4-V003Z	93266	10	118



MAP



l kW
C
Y
I



Type-N°

Stock-N°

kPa from
kPa to

FIAT

PANDA (169_)

1.3 D Multijet	1.248	51	4	09.2003-	188A9.000		EPBMBN3-V001Z	92099	20	256
1.3 D Multijet 4x4	1.248	51	4	10.2004-	188A9.000		EPBMBN3-V001Z	92099	20	256
1.3 D Multijet	1.248	55	4	06.2006- 08.2013	169A1.000		EPBMBN3-V001Z	92099	20	256
1.3 JTD Multijet 4x4	1.248	55	4	09.2010- 08.2013	169A1.000		EPBMBN3-V001Z	92099	20	256
1.4 Natural Power	1.368	57	4	-12.2012	350A1.000		EPBMPT4-V003Z	93266	10	118
1.4	1.368	74	4	-09.2010	169A3.000		EPBMPT4-V003Z	93266	10	118

PANDA (312_, 319_)

0.9	964	44	2	12.2013-	312A4.000, 312A6.000		EPBMPT4-V003Z	93266	10	118
0.9	964	48	2	02.2012-	312A4.000		EPBBPT4-V001Z	92565	11	307
0.9	964	48	2	02.2012-	312A4.000		EPBMPT4-V003Z	93266	10	118
0.9	964	48	2	02.2012-	312A4.000		EPBBPN3-V007Z	97073	20	300
0.9	875	57	2	02.2012-	312A2.000, 312A7.000		EPBBPN3-V007Z	97073	20	300
0.9	875	59	2	12.2013-	312A5.000		EPBBPN3-V007Z	97073	20	300
0.9 Natural Power	875	59	2	01.2015-	312A2.000		EPBBPN3-V007Z	97073	20	300
0.9	875	63	2	02.2012-	312A2.000		EPBBPT4-V001Z	92565	11	307
0.9	875	63	2	02.2012-	312A2.000		EPBBPN3-V007Z	97073	20	300
0.9 4x4	875	63	2	09.2012-	312A2.000		EPBBPN3-V007Z	97073	20	300
0.9 Natural Power	875	63	2	07.2012-	312A2.000		EPBBPN3-V007Z	97073	20	300
0.9 4x4	875	66	2	06.2014-	312A2.000, 312A7.000		EPBBPN3-V007Z	97073	20	300
1.2	1.242	51	4	02.2012-	169A4.000		EPBMPT4-V003Z	93266	10	118
1.2	1.242	51	4	02.2012-	169A4.000		EPBBPN3-V007Z	97073	20	300
1.2 LPG	1.242	51	4	06.2012-	169A4.000		EPBMPT4-V003Z	93266	10	118
1.3 D Multijet	1.248	55	4	02.2012-	199A1.000, 199A9.000		EPBBPT4-V001Z	92565	11	307

PUNTO (176_)

55 1.1	1.108	40	4	09.1993- 09.1999	176A6.000, 176B2.000		EPBMPN3-A002Z	96249	15	100
60 1.2	1.242	43	4	04.1994- 06.2000	176A7.000		EPBMPN3-A002Z	96249	15	100
60 1.2	1.242	44	4	09.1993- 06.2000	176B1.000, 176B4.000		EPBMPN3-A002Z	96249	15	100
75 1.2	1.242	54	4	10.1993- 09.1999	176A8.000		EPBMPN3-A002Z	96249	15	100
90 1.6	1.581	65	4	01.1994- 04.1997	176A9.000		EPBMPN3-A003Z	92477	15	102

PUNTO (188_)

1.2 60	1.242	44	4	-06.2003	188A4.000	; Type: 188AXA1A	EPBMPT4-V012Z	91940	20	100
1.2 60	1.242	44	4	07.2003-	188A4.000		EPBMPT4-V003Z	93266	10	118
1.2 60	1.242	44	4	09.1999- 12.2010	188A4.000	; Type: 188AX, 188BX	EPBMPT4-V012Z	91940	20	100
1.2 Bipower	1.242	44	4	08.2001- 05.2003	188A4.000		EPBMPT4-V012Z	91940	20	100
1.2 Natural Power	1.242	44	4	09.2003- 03.2012	188A4.000		EPBMPT4-V012Z	91940	20	100
1.2 Natural Power	1.242	44	4	-12.2010	188A4.000		EPBMPT4-V003Z	93266	10	118
1.2 16V 80	1.242	59	4	09.1999- 04.2006	188A5.000		EPBMPT4-V003Z	93266	10	118



MAP



l kW
C
Y
I



Type-N°

Stock-N°

kPa from

kPa to

FIAT

PUNTO (188_)

1.3 JTD 16V	1.248	51	4	06.2003-03.2012	188A9.000		EPBMBN3-V001Z	92099	20	256
1.4	1.368	70	4	-12.2010	843A1.000		EPBMPT4-V003Z	93266	10	118
1.9 JTD 80	1.910	59	4	09.1999-03.2012	188A2.000		EPBBPN3-V034Z	96381	20	250
1.9 JTD	1.910	63	4	02.2000-03.2012	188A7.000		EPBMBN3-V001Z	92099	20	256
1.9 JTD	1.910	74	4	06.2003-03.2012	188B2.000		EPBBPT4-V001Z	92565	11	307

PUNTO (199_)

0.9 Bifuel	875	63	2	03.2012-	312A2.000		EPBBPT4-V001Z	92565	11	307
0.9	875	74	2	12.2013-	199B6.000, 199B7.000		EPBBPN3-V007Z	97073	20	300
0.9	875	77	2	07.2013-	199B6.000		EPBBPN3-V007Z	97073	20	300
1.2	1.242	49	4	01.2015-	199B9.000		EPBMPT4-V003Z	93266	10	118
1.2	1.242	51	4	03.2012-	169A4.000		EPBMPT4-V003Z	93266	10	118
1.3 D Multijet	1.248	55	4	03.2012-	199A2.000		EPBMBN3-V001Z	92099	20	256
1.3 D Multijet	1.248	59	4	12.2013-	199B8.000		EPBMBN3-V001Z	92099	20	256
1.3 D Multijet	1.248	62	4	03.2012-	199B4.000		EPBMBN3-V001Z	92099	20	256
1.3 D Multijet	1.248	70	4	03.2012-	199B1.000, 330A1.000		EPBMBN3-V001Z	92099	20	256
1.3 D Multijet	1.248	70	4	03.2009-	199B1.000		EPBBPT4-V001Z	92565	11	307
1.4	1.368	55	4	03.2012-	199A7.000	;	EPBMPN3-V022Z	91412	10	117
1.4	1.368	55	4	03.2012-	199A7.000		EPBMPT4-V003Z	93266	10	118
1.4	1.368	57	4	03.2012-	350A1.000	;	EPBMPN3-V022Z	91412	10	117
1.4	1.368	57	4	03.2012-	350A1.000		EPBMPT4-V003Z	93266	10	118
1.4 Bifuel	1.368	57	4	03.2012-	350A1.000		EPBMPT4-V003Z	93266	10	118
1.4 LPG	1.368	57	4	03.2012-	350A1.000	; Number of Poles: 3	EPBMPN3-V022Z	91412	10	117
1.4 Natural Power	1.368	57	4	03.2012-	350A1.000		EPBMPT4-V003Z	93266	10	118
1.4 Natural Power	1.368	57	4	03.2009-	350A1.000	; Number of Poles: 3	EPBMPN3-V022Z	91412	10	117
1.4 Multi Air	1.368	77	4	03.2012-	955A6.000		EPBMPT4-V003Z	93266	10	118
1.4 Turbo Multi Air	1.368	99	4	03.2012-	955A2.000	; Position: Intake Manifold; India	EPBMPT4-V028Z	93902	11,2	250
1.4 Turbo Multi Air	1.368	99	4	03.2012-	955A2.000		EPBBPN3-V007Z	97073	20	300

PUNTO EVO (199_)

1.2	1.242	48	4	-12.2011	199A4.000		EPBMPT4-V003Z	93266	10	118
1.2	1.242	51	4	09.2010-12.2011	169A4.000		EPBMPT4-V003Z	93266	10	118
1.3 D Multijet	1.248	55	4	10.2009-02.2012	199A2.000		EPBMBN3-V001Z	92099	20	256
1.3 D Multijet	1.248	55	4	10.2009-02.2012	199A2.000, 199A9.000		EPBBPT4-V001Z	92565	11	307
1.3 D Multijet	1.248	62	4	10.2009-02.2012	199B4.000, 223A9.000		EPBMBN3-V001Z	92099	20	256
1.3 D Multijet	1.248	62	4	10.2009-02.2012	199B4.000, 223A9.000		EPBBPT4-V001Z	92565	11	307
1.3 D Multijet	1.248	66	4	10.2009-02.2012	199A3.000	; Position: Intake Manifold	EPBMBN3-V001Z	92099	20	256
1.3 D Multijet	1.248	70	4	10.2009-02.2012	199B1.000		EPBMBN3-V001Z	92099	20	256
1.3 D Multijet	1.248	70	4	10.2009-02.2012	199B1.000		EPBBPT4-V001Z	92565	11	307



MAP



l kW
C
Y
I



Type-N°

Stock-N°

kPa from
kPa to

FIAT

PUNTO EVO (199_)

1.4	1.368	55	4	07.2009-02.2012	199A7.000		EPBMPN3-V022Z	91412	10	117
1.4	1.368	55	4	10.2009-12.2011	199A7.000		EPBMPT4-V003Z	93266	10	118
1.4 Natural Power	1.368	57	4	-12.2011	350A1.000		EPBMPT4-V003Z	93266	10	118
1.4	1.368	57	4	-12.2011	350A1.000		EPBMPT4-V003Z	93266	10	118
1.4	1.368	57	4	10.2009-02.2012	350A1.000		EPBMPN3-V022Z	91412	10	117
1.4	1.368	57	4	10.2009-02.2012	350A1.000		EPBBPN3-V007Z	97073	20	300
1.4 LPG	1.368	57	4	10.2009-12.2011	350A1.000		EPBMPT4-V003Z	93266	10	118
1.4 LPG	1.368	57	4	06.2009-02.2012	350A1.000		EPBBPN3-V007Z	97073	20	300
1.4 Natural Power	1.368	57	4	10.2009-02.2012	350A1.000	; Number of Poles: 3; Position: Suction Pipe	EPBMPN3-V022Z	91412	10	117
1.4 Natural Power	1.368	57	4	10.2009-02.2012	350A1.000		EPBBPN3-V007Z	97073	20	300
1.4 16V	1.368	77	4	-12.2011	955A6.000		EPBMPT4-V003Z	93266	10	118
1.4 16V	1.368	77	4	10.2009-02.2012	955A6.000		EPBBPN3-V007Z	97073	20	300
1.4 16V	1.368	99	4	10.2009-02.2012	955A2.000	; Number of Poles: 3; Position: Suction Pipe	EPBMPN3-V022Z	91412	10	117
1.4 16V	1.368	99	4	10.2009-02.2012	955A2.000		EPBBPN3-V007Z	97073	20	300
1.6 D Multijet	1.598	88	4	10.2009-02.2012	955A3.000		EPBMBN3-V001Z	92099	20	256
1.6 D Multijet	1.598	88	4	10.2009-02.2012	955A3.000		EPBBPT4-V001Z	92565	11	307

QUBO (225_)

1.3 D Multijet	1.248	55	4	02.2008-	199A2.000		EPBMBN3-V001Z	92099	20	256
1.3 D Multijet	1.248	55	4	02.2008-	199A2.000, 199A9.000		EPBBPT4-V001Z	92565	11	307
1.3 D Multijet	1.248	70	4	07.2010-	199B1.000		EPBMBN3-V001Z	92099	20	256
1.3 D Multijet	1.248	70	4	07.2010-	199B1.000		EPBBPT4-V001Z	92565	11	307
1.4	1.360	54	4	02.2008-	KFT, KfV		EPBMPT4-A001Z	93136	10	117
1.4	1.368	57	4	09.2014-	350A1.000		EPBMPT4-V003Z	93266	10	118
1.4 Natural Power	1.368	57	4	10.2009-	350A1.000		EPBMPT4-V003Z	93266	10	118

SCUDO (220_)

2.0 JTD	1.997	69	4	10.1999-12.2006	RHX		EPBBPN3-A003Z	91268	10	250
2.0 JTD	1.997	80	4	12.2002-12.2006	RHZ		EPBBPN3-A003Z	91268	10	250
2.0 JTD	1.997	80	4	12.1999-12.2006	RHZ		EPBBPN3-A006Z	91736	10	240
2.0 JTD 16V	1.997	80	4	05.1999-12.2006	RHW(DW10ATED4), RHM(DW10ATED4), RHK(DW10UTED4)		EPBBPN3-A003Z	91268	10	250
2.0	1.997	100	4	05.2000-12.2006	RFN(EW10J4)		EPBMPN3-A007Z	96754	20	105

SCUDO (270_, 272_)

1.6 D Multijet	1.560	66	4	01.2007-	9HU	; Position: Intake Manifold	EPBBPN3-A001Z	94263	10	240
2.0 D Multijet	1.997	88	4	01.2007-	RHK		EPBBPN3-A001Z	94263	10	240
2.0 D Multijet	1.997	94	4	04.2011-	RH02		EPBMBT4-A003Z	93024	12,9	316,5
2.0 D Multijet 4x4	1.997	94	4	04.2011-	RH02	; Position: Suction Pipe	EPBMBT4-A003Z	93024	12,9	316,5
2.0 D Multijet	1.997	100	4	01.2007-	RHR, DW10BTED4	; Position: Intake Manifold	EPBBPN3-A001Z	94263	10	240



MAP



l kW
C
Y
I



Type-N°

Stock-N°

kPa from

kPa to

FIAT

SCUDO (270_, 272_)

2.0 D Multijet	1.997	120	4	07.2010-	RH02, RHH	; Position: Suction Pipe	EPBMBT4-A003Z	93024	12,9	316,5
----------------	-------	-----	---	----------	-----------	--------------------------	---------------	-------	------	-------

SEDICI (FY_)

1.6 16V	1.586	79	4	06.2006-10.2014	M16A		EPBMPN3-V031Z	92481	10	120
1.6 16V 4x4	1.586	79	4	06.2006-10.2014	M16A		EPBMPN3-V031Z	92481	10	120
1.6 16V	1.586	88	4	06.2006-10.2014	M16A		EPBMPN3-V031Z	92481	10	120
1.6 16V 4x4	1.586	88	4	06.2006-10.2014	M16A		EPBMPN3-V031Z	92481	10	120
1.9 D Multijet	1.910	88	4	06.2006-10.2011	D19AA		EPBBPT4-V001Z	92565	11	307
1.9 D Multijet 4x4	1.910	88	4	06.2006-10.2011	D19AA		EPBBPT4-V001Z	92565	11	307
2.0 D Multijet	1.956	99	4	06.2006-10.2014	D20AA		EPBBPT4-V001Z	92565	11	307
2.0 D Multijet 4x4	1.956	99	4	06.2006-10.2014	D20AA		EPBBPT4-V001Z	92565	11	307

SEICENTO / 600 (187_)

0.9	899	29	4	11.1997-12.2008	1170A1.046		EPBMPN3-A002Z	96249	15	100
1.1	1.108	40	4	01.1998-01.2010	187A1.000		EPBMPT4-V012Z	91940	20	100
1.1	1.108	40	4	01.1998-01.2010	176B2.000, 187A1.000		EPBMPN3-A002Z	96249	15	100

SIENA (178_, 172_) | ALBEA

1.2	1.242	44	4	09.2001-12.2012	178C4.066, 188A4.000		EPBMPN3-A002Z	96249	15	100
1.2	1.242	54	4	09.1998-12.2002	178B5.000		EPBMPN3-A002Z	96249	15	100
1.4	1.372	51	4	04.1996-12.2009	178B2.000		EPBMPN3-A002Z	96249	15	100
1.4 Cat	1.372	51	4	04.1996-12.2009	178B2.016		EPBMPN3-A002Z	96249	15	100
1.4	1.368	57	4	01.2007-12.2009	350A1.000, 178F3.011		EPBMPN3-V022Z	91412	10	117
1.6 16V	1.581	74	4	06.2000-	178B3.000	; RPO: TRY	EPBMPT4-V012Z	91940	20	100
1.6 16V	1.581	74	4	09.1998-12.2009	178B3.000		EPBMPN3-A002Z	96249	15	100
1.6	1.596	76	4	11.2000-12.2012	182B6.000		EPBMPT4-V012Z	91940	20	100
1.6	1.596	76	4	11.2000-12.2012	182B6.000		EPBMPN3-A002Z	96249	15	100

STILO (192_)

1.2 16V	1.242	59	4	-12.2003	188A5.000		EPBMPT4-V003Z	93266	10	118
1.4 16V	1.368	66	4	03.2005-12.2007	192B2.000		EPBMPT4-V003Z	93266	10	118
1.4 16V	1.368	70	4	10.2003-12.2007	843A1.000		EPBMPT4-V003Z	93266	10	118
1.6 16V	1.596	76	4	10.2001-08.2008	182B6.000		EPBMPT4-V012Z	91940	20	100
1.6	1.596	100	4	04.2005-08.2008	182B6.000		EPBMPT4-V012Z	91940	20	100
1.9 JTD	1.910	59	4	02.2002-08.2008	192A3.000		EPBMBN3-V001Z	92099	20	256
1.9 D	1.910	66	4	09.2004-08.2008	192B5.000		EPBBPT4-V001Z	92565	11	307
1.9 D Multijet	1.910	74	4	09.2005-08.2008	192A9.000		EPBMBN3-V001Z	92099	20	256
1.9 JTD	1.910	85	4	10.2001-11.2006	192A1.000, 937A7.000		EPBBPT4-V001Z	92565	11	307
1.9 JTD	1.910	85	4	01.2003-08.2008	192A1.000, 937A7.000		EPBMBN3-V001Z	92099	20	256
1.9 D Multijet	1.910	88	4	09.2005-08.2008	192A8.000		EPBBPT4-V001Z	92565	11	307
1.9 JTD	1.910	93	4	09.2003-11.2006	937A4.000		EPBBPT4-V001Z	92565	11	307



MAP



l kW
C
Y
I



Type-N°

Stock-N°

kPa from
kPa to

FIAT

STILO (192_)

1.9 JTD	1.910	103	4	01.2004-08.2008	192A5.000		EPBBPT4-V001Z	92565	11	307
1.9 D Multijet	1.910	110	4	09.2005-08.2008	937A5.000		EPBBPT4-V001Z	92565	11	307

STRADA PICKUP (178_)

1.2	1.242	44	4	04.2003-	188A4.000		EPBMPT4-V012Z	91940	20	100
1.2	1.242	54	4	06.1999-12.2006	178B5.000		EPBMPN3-A002Z	96249	15	100
1.3 D Multijet	1.248	62	4	05.2006-	223A9.000		EPBBPT4-V001Z	92565	11	307
1.9 JTD	1.910	59	4	04.2003-	188A2.000		EPBMBN3-V001Z	92099	20	256

TEMPRA (159_)

1.6	1.581	63	4	03.1990-04.1994	159A3.000, 159B9.000		EPBMPN3-A003Z	92477	15	102
1.6 i.e.	1.581	63	4	06.1994-08.1996	159B9.000		EPBMPN3-A003Z	92477	15	102
1.6 i.e.	1.581	66	4	06.1994-08.1996	159B9.000		EPBMPN3-A003Z	92477	15	102
1.8 i.e.	1.756	66	4	09.1993-08.1996	835C4.000		EPBMPN3-A002Z	96249	15	100
1.8 i.e.	1.756	74	4	10.1994-08.1996	836A5.000		EPBMPN3-A002Z	96249	15	100
1.8 i.e.	1.756	76	4	09.1993-08.1996	835C2.000		EPBMPN3-A002Z	96249	15	100
1.8 i.e.	1.756	77	4	03.1992-08.1996	159A4.046		EPBMPN3-A002Z	96249	15	100
1.8 i.e.	1.756	81	4	03.1990-08.1996	159A4.000		EPBMPN3-A002Z	96249	15	100
2.0 i.e.	1.995	83	4	10.1990-09.1996	159A6.046		EPBMPN3-A002Z	96249	15	100
2.0 i.e. 4x4	1.995	83	4	03.1992-03.1995	159A6.046		EPBMPN3-A002Z	96249	15	100

TIPO (160_)

1.8 i.e.	1.756	76	4	04.1993-04.1995	835C2.000		EPBMPN3-A002Z	96249	15	100
1.8 i.e. 16V Sport	1.756	100	4	11.1989-06.1992	160A5.000		EPBMPN3-A002Z	96249	15	100
2.0 i.e.	1.995	83	4	03.1990-04.1995	159A6.046		EPBMPN3-A002Z	96249	15	100
2.0 i.e. 16V Sport	1.995	102	4	03.1993-04.1995	836A3.000		EPBMPN3-A002Z	96249	15	100
2.0 16V	1.995	107	4	07.1991-04.1995	160A8.046		EPBMPN3-A002Z	96249	15	100

TIPO (356_) | EGEEA

1.4	1.368	88	4	03.2016-	940B7.000		EPBMPT4-V028Z	93902	11,2	250
1.4	1.368	88	4	03.2016-	940B7.000		EPBBPN3-V007Z	97073	20	300
1.4 LPG	1.368	88	4	05.2016-	940B7.000		EPBBPN3-V007Z	97073	20	300

ULYSSE (179_)

2.0 JTD	1.997	79	4	05.2003-08.2006	RHM(DW10ATED4)		EPBBPN3-A006Z	91736	10	240
2.0 JTD	1.997	80	4	08.2002-08.2006	RHW(DW10ATED4)		EPBBPN3-A003Z	91268	10	250
2.0 D Multijet	1.997	88	4	05.2006-06.2011	RHK		EPBBPN3-A001Z	94263	10	240
2.0	1.997	100	4	08.2002-06.2011	RFN(EW10J4)		EPBMPN3-A020Z	96725	20	117
2.2 JTD	2.179	94	4	-06.2003	4HW(DW12ATED4)		EPBBPN3-A003Z	91268	10	250
2.2 JTD	2.179	94	4	06.2003-	4HW(DW12ATED4)		EPBBPN3-A006Z	91736	10	240
2.2 D Multijet	2.179	125	4	03.2008-06.2011	4HS		EPBBPN3-A017Z	95311	35	320
2.2 D Multijet	2.179	125	4	03.2008-06.2011	4HS		EPBBPN3-A018Z	95753	35	320
3.0	2.946	150	6	08.2002-06.2011	XFW		EPBMPN3-A020Z	96725	20	117



MAP



l kW
C
Y
I



Type-N°

Stock-N°

kPa from

kPa to

FIAT

ULYSSE (179_)

2.0 D Multijet	1.997	100	4	05.2006-06.2011	RHR		EPBBPN3-A001Z	94263	10	240
----------------	-------	-----	---	-----------------	-----	--	---------------	-------	----	-----

ULYSSE (220_)

1.8	1.761	73	4	05.1997-08.2002	LFW(XU7JP)		EPBMPN3-A002Z	96249	15	100
2.0 JTD 16V	1.997	80	4	05.1999-08.2002	RHW(DW10ATED4)		EPBBPN3-A003Z	91268	10	250
2.0 JTD	1.997	80	4	10.1999-08.2002	RHZ		EPBBPN3-A003Z	91268	10	250
2.0	1.998	89	4	06.1994-08.2002	RFU(XU10J2C)		EPBMPN3-A002Z	96249	15	100
2.0 16V	1.998	97	4	-12.1998	RFV		EPBMPN3-A009Z	92952	20	100
2.0 16V	1.998	97	4	12.1998-	RFV		EPBMPN3-A007Z	96754	20	105
2.0 16V	1.997	100	4	09.2000-08.2002	RFN(EW10J4)		EPBMPN3-A007Z	96754	20	105
2.1 TD	2.088	80	4	03.1996-10.1999	P8C		EPBBPN3-A027Z	92471	10	200

FORD

B-MAX (JK)

1.0 EcoBoost	998	74	3	10.2012-	SFJA, SFJB, SFJC, SFJD		EPBMPN3-V019Z	93061	10	307,5
1.0 EcoBoost	998	88	3	10.2012-	M1JA		EPBMPN3-V019Z	93061	10	307,5
1.0 EcoBoost	998	92	3	10.2012-	M1JE		EPBMPN3-V019Z	93061	10	307,5
1.0 EcoBoost	998	103	3	02.2016-	YYJC		EPBMPT4-V028Z	93902	11,2	250
1.5 TDCi	1.499	55	4	10.2012-	UGJC, XUJA, XUJB, UGJG		EPBBPN3-A017Z	95311	35	320
1.5 TDCi	1.499	70	4	04.2015-	XVJA		EPBMBT4-A003Z	93024	12,9	316,5
1.6 TDCi	1.560	70	4	10.2012-	T3JB		EPBMBT4-A003Z	93024	12,9	316,5

C-MAX (DM2)

1.6 TDCi	1.560	66	4	02.2007-09.2010	GPDA, HHDA, HHDB		EPBBPN3-A001Z	94263	10	240
1.6	1.596	74	4	02.2007-09.2010	HWDA, HWDB, SHDA, SHDB, SHDC		EPBMPT4-A007Z	96755	10	120
1.6 TDCi	1.560	74	4	02.2007-09.2010	G8DC, MTDA		EPBBPN3-A001Z	94263	10	240
1.6 TDCi	1.560	80	4	02.2007-09.2010	G8DA, G8DB, G8DD		EPBBPN3-A001Z	94263	10	240
1.6	1.596	85	4	04.2007-09.2010	HXDA, HXDB, SIDA		EPBMPT4-A007Z	96755	10	120
1.8 TDCi	1.753	85	4	02.2007-09.2010	KKDA, KKDB		EPBBPN3-V021Z	95679	20	300
1.8	1.798	90	4	02.2007-09.2010	QQDC		EPBMPT4-A017Z	96798	10	115
1.8	1.798	92	4	02.2007-09.2010	QQDA, QQDB		EPBMPT4-A017Z	96798	10	115
1.8 Flexifuel	1.798	92	4	02.2007-09.2010	Q7DA		EPBMPT4-A017Z	96798	10	115
2.0 TDCi	1.997	81	4	02.2008-09.2010	IXDA		EPBBPN3-A001Z	94263	10	240
2.0 TDCi	1.997	98	4	02.2007-09.2010	G6DC, G6DE, G6DF		EPBBPN3-A001Z	94263	10	240
2.0 TDCi	1.997	100	4	02.2007-09.2010	G6DA, G6DB, G6DD, G6DG		EPBBPN3-A001Z	94263	10	240
2.0	1.999	107	4	02.2007-09.2010	AODA, AODB, AODE, SYDA		EPBMPT4-A017Z	96798	10	115
2.0 CNG	1.999	107	4	04.2009-09.2010	SYDA		EPBMPT4-A017Z	96798	10	115
2.0 LPG	1.999	107	4	06.2008-09.2010	SYDA		EPBMPT4-A017Z	96798	10	115

C-MAX II / C-MAX II VAN (DXA/CB7, DXA/CEU)

1.0 EcoBoost	998	74	3	-01.2018	M2DA		EPBMPN3-V019Z	93061	10	307,5
--------------	-----	----	---	----------	------	--	---------------	-------	----	-------



MAP



l kW
C
Y
I



Type-N°

Stock-N°

kPa from
kPa to

FORD

C-MAX II / C-MAX II VAN (DXA/CB7, DXA/CEU)

1.0 EcoBoost	998	74	3	10.2012-	SFDA	; Position: Intake Manifold	EPBMPN3-V019Z	93061	10	307,5
1.0 EcoBoost	998	92	3	-01.2018	M1DA		EPBMPN3-V019Z	93061	10	307,5
1.0 EcoBoost	998	92	3	10.2012-	B7DA		EPBMPN3-V019Z	93061	10	307,5
1.5 EcoBoost	1.498	110	4	03.2015-	M8DB		EPBMPT4-V028Z	93902	11,2	250
1.5 EcoBoost	1.498	134	4	03.2015-	M9DB		EPBMPT4-V028Z	93902	11,2	250
1.6 TDCi	1.560	70	4	12.2010-	T3DA, T3DB	; Position: Intake Manifold	EPBMBT4-A003Z	93024	12,9	316,5
1.6 TDCi	1.560	85	4	12.2010-	T1DA	; Position: Intake Manifold	EPBMBT4-A003Z	93024	12,9	316,5
1.6 LPG	1.596	86	4	02.2012-	MUDA		EPBMPT4-A007Z	96755	10	120
1.6 Flexifuel	1.596	88	4	02.2011-	MUDA, MUDD		EPBMPT4-A007Z	96755	10	120
1.6 EcoBoost	1.596	110	4	12.2010-	JQDA, JQDB		EPBMPT4-V028Z	93902	11,2	250
1.6 EcoBoost	1.596	134	4	12.2010-	JTDA, JTDB		EPBMPT4-V028Z	93902	11,2	250
2.0 TDCi	1.997	85	4	02.2011-	TYDA	; Position: Intake Manifold	EPBMBT4-A003Z	93024	12,9	316,5
2.0 TDCi	1.997	100	4	02.2011-	UKDB	; Position: Intake Manifold	EPBMBT4-A003Z	93024	12,9	316,5
2.0 TDCi	1.997	103	4	04.2010-	UFDB	; Position: Intake Manifold	EPBMBT4-A003Z	93024	12,9	316,5
2.0 TDCi	1.997	110	4	03.2015-	T7DB, T7DC, T7DD	; Position: Intake Manifold	EPBMBT4-A003Z	93024	12,9	316,5
2.0 TDCi	1.997	120	4	12.2010-	TXDB	; Position: Intake Manifold	EPBMBT4-A003Z	93024	12,9	316,5
2.0 Energi	1.999	136	4	01.2015-	UADA		EPBMPN4-A035Z	96317	10	115

ECOSPORT

1.0 EcoBoost	998	74	3	04.2018-	SFJL		EPBMPT4-V028Z	93902	11,2	250
1.0 EcoBoost	998	92	3	-10.2017	M1JC, M1JJ, M1JU		EPBMPN3-V019Z	93061	10	307,5
1.0 EcoBoost	998	92	3	11.2017-	M1JC, M1JJ, M1JU		EPBMPT4-V028Z	93902	11,2	250
1.0 EcoBoost	998	103	3	-10.2017	YYJD		EPBMPN3-V019Z	93061	10	307,5
1.0 EcoBoost	998	103	3	11.2017-	YYJD		EPBMPT4-V028Z	93902	11,2	250
1.5 TDCi	1.499	66	4	10.2013-	UGJE		EPBMBT4-A003Z	93024	12,9	316,5
1.5 TDCi	1.499	70	4	05.2015-	XVJD		EPBMBT4-A003Z	93024	12,9	316,5

ESCORT V (AAL, ABL)

RS Cosworth 4x4	1.994	162	4	-06.1994	N5F		EPBMPN3-A043Z	92940	20	250
-----------------	-------	-----	---	----------	-----	--	---------------	-------	----	-----

FIESTA III (GFJ, F3L, F5L, J5_, J3_)

1.6 Turbo	1.598	96	4	03.1990-10.1992	LHA		EPBBPN3-A033Z	96394	20	200
-----------	-------	----	---	-----------------	-----	--	---------------	-------	----	-----

FIESTA III BOX (J5_, J3_, JV_)

1.3	1.299	44	4	02.1996-08.2003	J4C		EPBMPT4-A036Z	97175	10	115
D 1.8	1.753	44	4	05.1998-04.2002	RTK, RTJ		EPBBPN3-A031Z	95922	40	250
1.8 DI	1.753	55	4	09.2000-08.2003	RTN, RTP		EPBMPN3-V008Z	90549	40	250
TD 1.8	1.753	55	4	03.2000-08.2003	RTN, RTP, RTQ		EPBMPN3-V008Z	90549	40	250
TD 1.8	1.753	55	4	03.2000-08.2003	RTN, RTP, RTQ		EPBBPN3-A031Z	95922	40	250
1.8 DI	1.753	55	4	09.2000-08.2003	RTN, RTP		EPBBPN3-A031Z	95922	40	250

FIESTA IV (JA_, JB_)

1.0 i	999	38	4	02.1997-09.1999	ZH10JRB		EPBMPT4-A036Z	97175	10	115
-------	-----	----	---	-----------------	---------	--	---------------	-------	----	-----



MAP



l kW
C
Y
I



Type-Nº

Stock-Nº

kPa from

kPa to

FORD

FIESTA IV (JA_, JB_)

1.25 i 16V	1,242	55	4	-12.1999	DHA, DHB, DHC, DHD, DHE, DHF, DHG		EPBMPT4-A036Z	97175	10	115
1.25 i 16V	1,242	55	4	01.2000-	DHA, DHB, DHC, DHD, DHE, DHF, DHG		EPBMPT4-V037Z	92354	15	117
1.3 i	1,299	37	4	08.1995-01.2002	JJA, JJC, JJE, JJJ, JJK, JJM		EPBMPT4-A036Z	97175	10	115
1.3 i	1,299	44	4	08.1995-01.2002	JBC, J4C, J4J, J4L, J4Q, J4R, J4T		EPBMPT4-A036Z	97175	10	115
1.4 i 16V	1,388	66	4	-12.1999	FHA, FHE		EPBMPT4-A036Z	97175	10	115
1.4 i 16V	1,388	66	4	12.1999-	FHA, FHE		EPBMPT4-V037Z	92354	15	117
1.8 D	1,753	44	4	08.1995-04.2000	RTK, RTJ		EPBBPN3-A031Z	95922	40	250
1.8 DI	1,753	55	4	04.2000-01.2002	RTN, RTP, RTQ		EPBMPN3-V008Z	90549	40	250
1.8 DI	1,753	55	4	04.2000-01.2002	RTN, RTP, RTQ		EPBBPN3-A031Z	95922	40	250

FIESTA V (JH_, JD_)

1.25 16V	1,242	51	4	03.2003-06.2008	M7JA, M7JB		EPBMPT4-A007Z	96755	10	120
1.25 16V	1,242	55	4	05.2002-06.2008	FUJA, FUJB		EPBMPT4-A007Z	96755	10	120
1.3	1,299	44	4	11.2001-06.2008	BAJA		EPBMPT4-A007Z	96755	10	120
1.3	1,299	51	4	11.2001-06.2008	A9JA, A9JB		EPBMPT4-A007Z	96755	10	120
1.4 TDCi	1,399	50	4	11.2001-06.2008	F6JA, F6JB		EPBBPN3-A006Z	91736	10	240
1.4 16V	1,388	59	4	11.2001-06.2008	FXJA, FXJB		EPBMPT4-A007Z	96755	10	120
1.6 TDCi	1,560	66	4	11.2004-06.2008	HHJA, HHJB		EPBBPN3-A001Z	94263	10	240
1.6 TDCi	1,560	66	4	11.2004-06.2008	HHJA, HHJB		EPBBPN3-A006Z	91736	10	240
1.6 16V	1,596	74	4	11.2001-06.2008	FYJA, FYJB		EPBMPT4-A007Z	96755	10	120
ST150	1,999	110	4	03.2005-06.2008	N4JB		EPBMPT4-A017Z	96798	10	115

FIESTA VI (CB1, CCN)

1.0 EcoBoost	998	74	3	01.2013-	SFJA, SFJB, SFJC, SFJD	;	EPBMPN3-V019Z	93061	10	307,5
1.0 EcoBoost	998	74	3	01.2013-	SFJA, SFJB, SFJC, SFJD	;	EPBMPT4-V028Z	93902	11,2	250
1.0 EcoBoost	998	92	3	09.2012-	M1JE, M1JH		EPBMPN3-V019Z	93061	10	307,5
1.0 Sport	998	103	3	05.2014-	YYJA, YYJB		EPBMPN3-V019Z	93061	10	307,5
1.25	1,242	44	4	06.2008-	STJA, STJB, STJC, STJD		EPBMPT4-A020Z	97897	10	115
1.25	1,242	60	4	06.2008-	SNJA, SNJB, SNJC, SNJD		EPBMPT4-A020Z	97897	10	115
1.4 TDCi	1,399	50	4	01.2009-	F6JB, F6JD		EPBBPN3-A006Z	91736	10	240
1.4 TDCi	1,399	51	4	07.2010-	F6JD, KVJA		EPBBPN3-A006Z	91736	10	240
1.4 TDCi	1,399	51	4	07.2010-	F6JD, KVJA		EPBBPN3-A017Z	95311	35	320
1.5 TDCi	1,499	55	4	09.2012-	UGJC, XUJA, XUJB		EPBBPN3-A017Z	95311	35	320
1.6 TDCi	1,560	55	4	06.2008-	HHJF, UBJA	; Position: Intake Manifold	EPBBPN3-A001Z	94263	10	240
1.6 TDCi	1,560	66	4	06.2008-	HHJD, HHJC, HHJE	; Position: Intake Manifold	EPBBPN3-A001Z	94263	10	240
1.6 TDCi	1,560	70	4	02.2010-	TZJA	; Position: Intake Manifold	EPBMBT4-A003Z	93024	12,9	316,5
1.6 Ti-VCT	1,596	88	4	06.2008-	HXJA, HXJB		EPBMPT4-A007Z	96755	10	120
1.6 Ti	1,596	99	4	12.2010-	U5JA		EPBMPT4-A007Z	96755	10	120



MAP



l kW
C
Y
I



Type-N°

Stock-N°

kPa from
kPa to

FORD

FIESTA VI (CB1, CCN)

1.6 ST	1.596	134	4	03.2013-	JTJA, JTJB		EPBMPN3-V019Z	93061	10	307,5
1.6 ST200	1.596	147	4	04.2016-	JTJC		EPBMPN3-V019Z	93061	10	307,5

FIESTA VII

1.0 EcoBoost	998	63	3	04.2018-	Q0JA, Q0JB, Q0JC, Q0JD		EPBMPT4-V028Z	93902	11,2	250
1.0 EcoBoost	998	74	3	-08.2018	SFJE, SFJF, SFJH, SFJJ, SFJK, SFJN, SFJP		EPBMPN3-V019Z	93061	10	307,5
1.0 EcoBoost	998	74	3	09.2018-	SFJE, SFJF, SFJH, SFJJ, SFJK, SFJN, SFJP		EPBMPT4-V028Z	93902	11,2	250
1.0 EcoBoost	998	92	3	05.2017-	M1JL, M1JM		EPBMPT4-V028Z	93902	11,2	250
1.0 EcoBoost	998	103	3	06.2017-	YYJE		EPBMPT4-V028Z	93902	11,2	250

FOCUS C-MAX (DM2)

1.6 TDCi	1.560	66	4	02.2005-03.2007	HHDA, HHDB	; Position: Suction Pipe	EPBBPN3-A001Z	94263	10	240
1.6	1.596	74	4	10.2003-03.2007	HWDA, HWDB		EPBMPT4-A007Z	96755	10	120
1.6 TDCi	1.560	80	4	10.2003-03.2007	G8DA, G8DB, G8DD, G8DE, G8DF		EPBBPN3-A001Z	94263	10	240
1.6 Ti	1.596	85	4	08.2004-03.2007	HXDA, SIDA		EPBMPT4-A007Z	96755	10	120
1.8 TDCi	1.753	85	4	01.2005-03.2007	KKDA, KKDB		EPBBPN3-V021Z	95679	20	300
1.8	1.798	88	4	10.2003-03.2007	CSDA, CSDB		EPBMPT4-A017Z	96798	10	115
1.8	1.798	90	4	09.2005-03.2007	QQDC		EPBMPT4-A017Z	96798	10	115
1.8 Flexifuel	1.798	92	4	01.2006-03.2007	Q7DA		EPBMPT4-A017Z	96798	10	115
1.8	1.798	92	4	04.2004-03.2007	Q7DA, QQDA, QQDB		EPBMPT4-A017Z	96798	10	115
2.0 TDCi	1.997	98	4	10.2003-03.2007	G6DC, G6DE, G6DF		EPBBPN3-A001Z	94263	10	240
2.0 TDCi	1.997	100	4	10.2003-03.2007	G6DA, G6DB, G6DD, G6DG	; Position: Throttle Housing	EPBBPN3-A001Z	94263	10	240
2.0	1.999	107	4	03.2004-03.2007	AODA, AODB, AODE, SYDA		EPBMPT4-A017Z	96798	10	115

FOCUS I (DAW, DBW, DFW, DNW)

1.4 16V	1.388	55	4	10.1998-11.2004	FXDA, FXDB, FXDC, FXDD		EPBMPT4-V015Z	95488	10	117
1.6 16V	1.596	74	4	10.1998-11.2004	FYDA, FYDB, FYDC, FYDD, FYDH		EPBMPT4-V015Z	95488	10	117
1.8 DI, TDDi	1.753	55	4	08.1999-11.2004	BHDA, BHDB		EPBMPN3-V008Z	90549	40	250
1.8 DI, TDDi	1.753	55	4	-09.2003	BHDA, BHDB		EPBBPN3-A031Z	95922	40	250
1.8 Turbo DI, TDDi	1.753	55	4	08.2001-03.2005	BHDA, BHDB		EPBMPN3-V008Z	90549	40	250
1.8 Turbo DI, TDDi	1.753	55	4	-09.2003	BHDA, BHDB		EPBBPN3-A031Z	95922	40	250
1.8 Turbo DI, TDDi	1.753	66	4	10.1998-11.2004	C9DA, C9DB, C9DC		EPBMPN3-V008Z	90549	40	250
1.8 Turbo DI, TDDi	1.753	66	4	-09.2003	C9DC, C9DA, C9DB		EPBBPN3-A031Z	95922	40	250
1.8 TDCi	1.753	74	4	-09.2003	FFDA		EPBBPN3-A031Z	95922	40	250
1.8 TDCi	1.753	74	4	08.2002-11.2004	FFDA		EPBMPN3-V008Z	90549	40	250
1.8 TDCi	1.753	85	4	03.2001-11.2004	F9DA, F9DB		EPBBPN3-A031Z	95922	40	250

FOCUS II (DA_, HCP, DP, DB_, FCH, DH, FFS, DS)

1.4	1.388	59	4	07.2004-09.2012	ASDA, ASDB		EPBMPT4-A007Z	96755	10	120
1.6 TDCi	1.560	66	4	01.2005-09.2012	GPDA, GPDB, GPDC, HHDA, HHDB		EPBBPN3-A001Z	94263	10	240
1.6	1.596	74	4	07.2004-09.2012	HWDA, HWDB, SHDA, SHDB, SHDC		EPBMPT4-A007Z	96755	10	120



MAP



l kW
C
Y
I



Type-N°

Stock-N°

kPa from

kPa to

FORD

FOCUS II (DA_, HCP, DP, DB_, FCH, DH, FFS, DS)

1.6 TDCi	1.560	74	4	07.2004-09.2012	G8DC, MTDA		EPBBPN3-A001Z	94263	10	240
1.6 TDCi	1.560	74	4	07.2004-09.2012	G8DC, MTDA		EPBMPT4-A007Z	96755	10	120
1.6 TDCi	1.560	80	4	07.2004-09.2012	G8DA, G8DB, G8DD, G8DE, G8DF		EPBBPN3-A001Z	94263	10	240
1.6 LPG	1.596	85	4	10.2009-07.2011	SIDA		EPBMPT4-A007Z	96755	10	120
1.6 Ti-VCT	1.596	85	4	07.2004-09.2012	HXDA, HXDB, SIDA		EPBMPT4-A007Z	96755	10	120
1.8 TDCi	1.753	85	4	01.2005-09.2012	KKDA		EPBBPN3-V021Z	95679	20	300
1.8	1.798	92	4	03.2006-09.2012	Q7DA, QQDA, QQDB		EPBMPT4-A017Z	96798	10	115
1.8 Flexifuel	1.798	92	4	01.2006-09.2012	Q7DA, QQDA, QQDB		EPBMPT4-A017Z	96798	10	115
2.0 TDCi	1.997	81	4	02.2008-07.2011	IXDA		EPBBPN3-A001Z	94263	10	240
2.0 TDCi	1.997	98	4	07.2004-01.2008	G6DE, G6DF		EPBBPN3-A001Z	94263	10	240
2.0 TDCi	1.997	100	4	07.2004-09.2012	G6DA, G6DB, G6DD, G6DG		EPBBPN3-A001Z	94263	10	240
2.0	1.999	107	4	07.2004-09.2012	AODA, AODB, AODE, SYDA		EPBMPT4-A017Z	96798	10	115
2.0 CNG	1.999	107	4	04.2009-07.2011	SYDA		EPBMPT4-A017Z	96798	10	115
2.0 LPG	1.999	107	4	06.2008-07.2011	SYDA		EPBMPT4-A017Z	96798	10	115
2.5 ST	2.522	166	5	10.2005-09.2012	HYDA		EPBBPT4-V013Z	91803	20	250
2.5 RS	2.521	224	5	01.2009-07.2011	JZDA		EPBBPT4-V009Z	95675	20	300

FOCUS III

1.0 EcoBoost	998	74	3	02.2012-	M2DA		EPBMPN3-V019Z	93061	10	307,5
1.0 EcoBoost	998	74	3	02.2012-	M2DA, SFDB, M2DB, M2DC		EPBMPT4-V028Z	93902	11,2	250
1.0 EcoBoost	998	92	3	02.2012-	M1DA, M1DC, M1DD	; Type: BK	EPBMPN3-V019Z	93061	10	307,5
1.0 EcoBoost	998	92	3	02.2012-	M1DA, M1DC, M1DD	; Type: C5	EPBMPT4-V028Z	93902	11,2	250
1.0 EcoBoost	998	103	3	10.2017-	M1DH		EPBMPT4-V028Z	93902	11,2	250
1.5 EcoBoost	1.498	110	4	09.2014-	M8DA, M8DB		EPBMPT4-V028Z	93902	11,2	250
1.5 TDCi ECOnetic	1.499	77	4	09.2014-	AEDA, XXDB	; Position: Intake Manifold	EPBMBT4-A003Z	93024	12,9	316,5
1.5 EcoBoost	1.498	134	4	09.2014-	M9DA, M9DB		EPBMPT4-V028Z	93902	11,2	250
1.6 TDCi	1.560	70	4	07.2010-	T3DA	; Position: Intake Manifold	EPBMBT4-A003Z	93024	12,9	316,5
1.6 TDCi ECOnetic	1.560	77	4	05.2012-	NGDA	; Position: Intake Manifold	EPBMBT4-A003Z	93024	12,9	316,5
1.6 TDCi ECOnetic	1.560	77	4	05.2012-	NGDA	; Position: Intake Manifold	EPBMBT4-A003Z	93024	12,9	316,5
1.6 TDCi	1.560	85	4	07.2010-	T1DB	; Position: Intake Manifold	EPBMBT4-A003Z	93024	12,9	316,5
1.6 Flexifuel	1.596	110	4	07.2013-	YUDA		EPBMPN3-V019Z	93061	10	307,5
1.6 EcoBoost	1.596	110	4	07.2010-	JQDA, JQDB		EPBMPN3-V019Z	93061	10	307,5
1.6 EcoBoost	1.596	110	4	07.2010-	YUDA	; Position: Intake Manifold	EPBMPN3-V019Z	93061	10	307,5
1.6 EcoBoost	1.596	110	4	07.2010-	YUDA	;	EPBMPN3-V019Z	93061	10	307,5
1.6 EcoBoost	1.596	134	4	07.2010-	JTDA, JTDB		EPBMPN3-V019Z	93061	10	307,5
2.0 TDCi	1.997	85	4	07.2010-	TYDA	; Position: Intake Manifold	EPBMBT4-A003Z	93024	12,9	316,5
2.0 TDCi	1.997	100	4	07.2010-	UKDB	; Position: Intake Manifold	EPBMBT4-A003Z	93024	12,9	316,5
2.0 TDCi	1.997	103	4	07.2010-	UFDB	; Position: Intake Manifold	EPBMBT4-A003Z	93024	12,9	316,5



MAP

 kW
C
Y
I

Type-N°

Stock-N°

 kPa from
kPa to

FORD
FOCUS III

2.0 TDCi	1.997	110	4	11.2014-	T7DA, T7DB	; Position: Intake Manifold	EPBMBT4-A003Z	93024	12,9	316,5
2.0 TDCi	1.997	120	4	07.2010-	TXDB	; Position: Intake Manifold	EPBMBT4-A003Z	93024	12,9	316,5
2.0 TDCi ST	1.997	136	4	11.2014-	T8DA	; Position: Intake Manifold	EPBMBT4-A003Z	93024	12,9	316,5
2.0 ST	1.999	184	4	07.2012-	R9DA, R9DB, R9DC, R9DD		EPBBPT4-V009Z	95675	20	300
2.0 ST	1.999	184	4	07.2012-	R9DA, R9DB, R9DC, R9DD		EPBMPN3-V019Z	93061	10	307,5
2.3 RS AWD	2.261	257	4	07.2015-	YVDA		EPBMPT4-V028Z	93902	11,2	250

FUSION (JU_)

1.25	1.242	55	4	08.2004-12.2012	FUJA, FUJB		EPBMPT4-A007Z	96755	10	120
1.3	1.299	44	4	11.2002-07.2005	BAJA		EPBMPT4-A007Z	96755	10	120
1.4	1.388	59	4	08.2002-12.2012	FXJA, FXJB, FXJC		EPBMPT4-A007Z	96755	10	120
1.4 LPG	1.388	59	4	01.2010-12.2012	UTJA	; Position: Throttle Housing	EPBMPT4-A007Z	96755	10	120
1.4 TDCi	1.399	50	4	08.2002-12.2012	F6JA, F6JB	; Position: Air Filter Housing	EPBBPN3-A006Z	91736	10	240
1.6 TDCi	1.560	66	4	11.2004-12.2012	HHJA, HHJB	; Position: Intake Manifold	EPBBPN3-A001Z	94263	10	240
1.6	1.596	74	4	08.2002-11.2008	FYJA, FYJB, FYJC		EPBMPT4-A007Z	96755	10	120

GALAXY (CK)

1.5 EcoBoost	1.499	118	4	01.2015-06.2018	UNCI, UNCJ		EPBMPT4-V028Z	93902	11,2	250
2.0 EcoBoost	1.999	176	4	01.2015-	R9CD, R9CI		EPBMPN3-V019Z	93061	10	307,5

GALAXY (WGR)

1.9 TDI	1.896	66	4	-05.2001	ANU		EPBMBT4-D001Z	91628	11	254
1.9 TDI	1.896	66	4	05.2001-	ANU		EPBBPT4-V003Z	91742	20	254
1.9 TDI	1.896	85	4	-05.2001	AUY		EPBMBT4-D001Z	91628	11	254
1.9 TDI	1.896	85	4	04.2000-05.2006	AUY	; Chass.>1U-3A	EPBBPT4-V003Z	91742	20	254
1.9 TDI	1.896	96	4	02.2003-05.2006	ASZ		EPBBPT4-V002Z	95912	20	300
1.9 TDI	1.896	110	4	05.2005-05.2006	BTB		EPBBPT4-V002Z	95912	20	300

GALAXY II (WA6)

1.6 TDCi	1.560	85	4	02.2011-06.2015	T1WA	; Position: Intake Manifold	EPBMBT4-A003Z	93024	12,9	316,5
1.6 EcoBoost	1.596	118	4	11.2010-06.2015	JTWA, JTWB		EPBMPN3-V019Z	93061	10	307,5
1.8 TDCi	1.753	74	4	05.2006-06.2015	FFWA		EPBBPN3-V021Z	95679	20	300
1.8 TDCi	1.753	92	4	05.2006-06.2015	QYWA		EPBBPN3-V021Z	95679	20	300
2.0 Flexifuel	1.999	107	4	-12.2014	TBWA, TBWB		EPBMPT4-A017Z	96798	10	115
2.0	1.999	107	4	05.2006-06.2015	AOWA, AOWB, TBWA, TBWB		EPBMPT4-A017Z	96798	10	115
2.0 TDCi	1.997	100	4	05.2006-06.2015	UKWA	; Position: Intake Manifold	EPBMBT4-A003Z	93024	12,9	316,5
2.0 TDCi	1.997	120	4	03.2010-06.2015	TXWA	; Position: Intake Manifold	EPBMBT4-A003Z	93024	12,9	316,5
2.0 EcoBoost	1.999	146	4	07.2010-06.2015	TNWB		EPBMPN3-V019Z	93061	10	307,5
2.0 EcoBoost	1.999	149	4	03.2010-06.2015	TNWA		EPBMPN3-V019Z	93061	10	307,5
2.0 EcoBoost	1.999	149	4	03.2010-06.2015	TNWA		EPBBPT4-V009Z	95675	20	300
2.2 TDCi	2.179	129	4	03.2008-12.2012	Q4WA	; Position: Intake Manifold	EPBBPN3-A018Z	95753	35	320



MAP



l kW
C
Y
I



Type-N°

Stock-N°

kPa from

kPa to

FORD

GALAXY II (WA6)

2.2 TDCi	2.179	147	4	11.2010-06.2015	KNWA	; Position: Intake Manifold	EPBBPN3-A018Z	95753	35	320
----------	-------	-----	---	-----------------	------	-----------------------------	---------------	-------	----	-----

GRAND C-MAX (DXA/CB7, DXA/CEU)

1.0 EcoBoost	998	74	3	10.2012-	M2DA		EPBMPN3-V019Z	93061	10	307,5
1.0 EcoBoost	998	74	3	10.2012-	SFDA	; Position: Intake Manifold	EPBMPN3-V019Z	93061	10	307,5
1.0 EcoBoost	998	92	3	10.2012-	M1DA, M1DD		EPBMPN3-V019Z	93061	10	307,5
1.5 EcoBoost	1.498	110	4	03.2015-	M8DB		EPBMPT4-V028Z	93902	11,2	250
1.5 EcoBoost	1.498	134	4	03.2015-	M9DB		EPBMPT4-V028Z	93902	11,2	250
1.6 TDCi	1.560	70	4	12.2010-	T3DA	; Position: Intake Manifold	EPBMBT4-A003Z	93024	12,9	316,5
1.6 TDCi	1.560	85	4	12.2010-	T1DA	; Position: Intake Manifold	EPBMBT4-A003Z	93024	12,9	316,5
1.6 EcoBoost	1.596	110	4	12.2010-	JQDA, JQDB		EPBMPT4-V028Z	93902	11,2	250
1.6 EcoBoost	1.596	134	4	12.2010-	JTDA, JTDB		EPBMPT4-V028Z	93902	11,2	250
2.0 TDCi	1.997	85	4	02.2011-	TYDA	; Position: Intake Manifold	EPBMBT4-A003Z	93024	12,9	316,5
2.0 TDCi	1.997	100	4	02.2011-	UKDB	; Position: Intake Manifold	EPBMBT4-A003Z	93024	12,9	316,5
2.0 TDCi	1.997	103	4	02.2011-	UFDB	; Position: Intake Manifold	EPBMBT4-A003Z	93024	12,9	316,5
2.0 TDCi	1.997	110	4	03.2015-	T7DB, T7DC	; Position: Intake Manifold	EPBMBT4-A003Z	93024	12,9	316,5
2.0 TDCi	1.997	120	4	12.2010-	TXDB	; Position: Intake Manifold	EPBMBT4-A003Z	93024	12,9	316,5

KA (RB_)

1.3 i	1.299	36	4	06.1998-11.2008	JJD, JJF, JJG, JJH, JJJ		EPBMPT4-A036Z	97175	10	115
1.3 i	1.299	37	4	09.1996-10.2002	JJB		EPBMPT4-A036Z	97175	10	115
1.3 i	1.299	44	4	09.1996-11.2008	J4D, J4K, J4M, J4N, J4P, J4S, BAA		EPBMPT4-A036Z	97175	10	115
1.3 i	1.299	51	4	08.2002-11.2008	A9A, A9B		EPBMPT4-A007Z	96755	10	120
1.6 i	1.597	70	4	02.2001-11.2008	CDB, CDC		EPBMPT4-A007Z	96755	10	120

KA (RU8)

1.3 TDCi	1.248	55	4	-11.2010	169A1000, FD4	; Position: Intake Manifold	EPBMBN3-V001Z	92099	20	256
----------	-------	----	---	----------	---------------	-----------------------------	---------------	-------	----	-----

KUGA I

2.0 TDCi	1.997	100	4	03.2008-11.2012	G6DG, UKDA	; Position: Throttle Housing	EPBBPN3-A001Z	94263	10	240
2.0 TDCi 4x4	1.997	100	4	03.2008-11.2012	G6DG, UKDA	; Position: Throttle Housing	EPBBPN3-A001Z	94263	10	240
2.0 TDCi	1.997	103	4	03.2010-11.2012	UFDA	; Position: Intake Manifold	EPBMBT4-A003Z	93024	12,9	316,5
2.0 TDCi 4x4	1.997	103	4	03.2010-11.2012	UFDA	; Position: Intake Manifold	EPBMBT4-A003Z	93024	12,9	316,5
2.0 TDCi 4x4	1.997	120	4	03.2010-11.2012	TXDA	; Position: Intake Manifold	EPBMBT4-A003Z	93024	12,9	316,5
2.5 4x4	2.522	147	5	02.2008-11.2012	HYDB, HYDC		EPBBPT4-V009Z	95675	20	300

KUGA II (DM2) | ESCAPE

1.5 EcoBoost	1.499	88	4	01.2016-	BNMA		EPBMPT4-V028Z	93902	11,2	250
1.5 EcoBoost	1.499	110	4	09.2014-	M8MA		EPBMPT4-V028Z	93902	11,2	250
1.5 EcoBoost 4x4	1.499	110	4	07.2016-	M8MA		EPBMPT4-V028Z	93902	11,2	250
1.5 EcoBoost 4x4	1.499	134	4	09.2014-	M9MA		EPBMPT4-V028Z	93902	11,2	250
1.6 EcoBoost	1.596	110	4	03.2013-	JQMA		EPBMPN3-V019Z	93061	10	307,5
1.6 EcoBoost	1.596	110	4	03.2013-	JQMB	; Position: Intake Manifold	EPBMPN3-V019Z	93061	10	307,5



MAP



l kW
C
Y
I



Type-N°

Stock-N°

kPa from
kPa to

FORD

KUGA II (DM2) | ESCAPE

1.6 EcoBoost 4x4	1.596	110	4	03.2013-	JQMA, JQMB		EPBMPN3-V019Z	93061	10	307,5
1.6 EcoBoost 4x4	1.596	132	4	10.2012-04.2015	JTMA		EPBMPN3-V019Z	93061	10	307,5
1.6 EcoBoost 4x4	1.596	134	4	03.2013-	JTMA		EPBMPN3-V019Z	93061	10	307,5
2.0 TDCi	1.998	85	4	03.2013-	TYMA	; Position: Suction Pipe	EPBMBT4-A003Z	93024	12,9	316,5
2.0 TDCi	1.998	88	4	09.2014-	XRMA, XRGB	; Position: Suction Pipe	EPBMBT4-A003Z	93024	12,9	316,5
2.0 TDCi	1.997	100	4	03.2013-	UKMA	; Position: Intake Manifold	EPBMBT4-A003Z	93024	12,9	316,5
2.0 TDCi 4x4	1.997	100	4	03.2013-	UKMA	; Position: Intake Manifold	EPBMBT4-A003Z	93024	12,9	316,5
2.0 TDCi	1.997	103	4	03.2013-	UFMA	; Position: Intake Manifold	EPBMBT4-A003Z	93024	12,9	316,5
2.0 TDCi 4x4	1.997	103	4	03.2013-	UFMA	; Position: Intake Manifold	EPBMBT4-A003Z	93024	12,9	316,5
2.0 TDCi	1.997	110	4	09.2014-	T7MB	; Position: Intake Manifold	EPBMBT4-A003Z	93024	12,9	316,5
2.0 TDCi 4x4	1.997	110	4	09.2014-	T7MA	; Position: Intake Manifold	EPBMBT4-A003Z	93024	12,9	316,5
2.0 TDCi 4x4	1.998	120	4	03.2013-	TXDA	; Position: Intake Manifold	EPBMBT4-A003Z	93024	12,9	316,5
2.0 TDCi 4x4	1.998	132	4	09.2014-	T8MA, T8MB	; Position: Intake Manifold	EPBMBT4-A003Z	93024	12,9	316,5

MAVERICK

2.3 16V	2.261	110	4	03.2004-	GZ		EPBMPN4-A035Z	96317	10	115
---------	-------	-----	---	----------	----	--	---------------	-------	----	-----

MONDEO III (B5Y, B4Y, BWY)

1.8 16V	1.798	81	4	10.2000-03.2007	CGBA, CGBB		EPBMPT4-A017Z	96798	10	115
1.8 16V	1.798	92	4	10.2000-03.2007	CHBA, CHBB		EPBMPT4-A017Z	96798	10	115
1.8 SCi	1.798	96	4	06.2003-03.2007	CFBA		EPBBPT4-A017Z	92559	50	300
1.8 SCi	1.798	96	4	06.2003-03.2007	CFBA		EPBMPN4-A034Z	95507	10	115
2.0 16V DI, TDDi, TDCi	1.998	66	4	10.2000-03.2007	D5BA, SDBA		EPBBPT4-A017Z	92559	50	300
2.0 16V DI, TDDi, TDCi	1.998	66	4	-09.2003	D5BA, SDBA	; 5-Speed; 6-Speed	EPBMPT4-V002Z	94153	40	261
2.0 16V TDDi, TDCi	1.998	85	4	10.2000-03.2007	D6BA, HJBA, HJBB, HJBC		EPBBPT4-A017Z	92559	50	300
2.0 16V TDDi, TDCi	1.998	85	4	-09.2003	D6BA, HJBA, HJBB, HJBC	; 5-Speed; 6-Speed	EPBMPT4-V002Z	94153	40	261
2.0 TDCi	1.998	96	4	10.2001-03.2007	FMBA, N7BA, N7BB		EPBBPT4-A017Z	92559	50	300
2.0 TDCi	1.998	96	4	-09.2003	FMBA, N7BA	; 5-Speed; 6-Speed	EPBMPT4-V002Z	94153	40	261
2.0 16V	1.999	107	4	10.2000-03.2007	CJBA, CJBB		EPBMPT4-A017Z	96798	10	115
2.2 TDCi	2.198	114	4	09.2004-03.2007	QJBA, QJBB		EPBBPT4-A017Z	92559	50	300

MONDEO IV (BA7)

1.6 TDCi	1.560	85	4	12.2010-01.2015	T1BA	; Position: Intake Manifold	EPBMBT4-A003Z	93024	12,9	316,5
1.6 EcoBoost	1.596	118	4	11.2010-01.2015	JTBB, JTBA		EPBMPN3-V019Z	93061	10	307,5
1.8 TDCi	1.753	74	4	03.2007-01.2015	FFBA		EPBBPN3-V021Z	95679	20	300
1.8 TDCi	1.753	92	4	06.2007-01.2015	KHBA, QYBA		EPBBPN3-V021Z	95679	20	300
2.0 TDCi	1.997	100	4	03.2007-12.2014	AZBC	; Position: Intake Manifold	EPBMBT4-A003Z	93024	12,9	316,5
2.0 TDCi	1.997	103	4	03.2007-01.2015	QXBA	; Position: Intake Manifold	EPBMBT4-A003Z	93024	12,9	316,5
2.0	1.999	107	4	03.2007-01.2015	AOBA, AOBC, TBBA, TBBA		EPBMPT4-A017Z	96798	10	115
2.0 Flexifuel	1.999	107	4	03.2009-01.2015	TBBA, TBBA		EPBMPT4-A017Z	96798	10	115



MAP



kW
C
Y
I



Type-N°

Stock-N°

kPa from

kPa to

FORD

MONDEO IV (BA7)

2.0 LPG	1.999	107	4	07.2009-01.2015	TBBA		EPBMPT4-A017Z	96798	10	115
2.0 TDCi	1.997	120	4	03.2010-01.2015	TXBA	; Position: Intake Manifold	EPBMBT4-A003Z	93024	12,9	316,5
2.0 SCTi	1.999	149	4	03.2010-01.2015	TNBA		EPBMPN3-V019Z	93061	10	307,5
2.0 SCTi	1.999	149	4	03.2010-01.2015	TNBA		EPBBPT4-V009Z	95675	20	300
2.0 EcoBoost	1.999	176	4	07.2010-01.2015	TPBA		EPBMPN3-V019Z	93061	10	307,5
2.0 EcoBoost	1.999	176	4	07.2010-01.2015	TPBA		EPBBPT4-V009Z	95675	20	300
2.2 TDCi	2.179	129	4	03.2008-10.2010	Q4BA	; Position: Intake Manifold	EPBBPN3-A018Z	95753	35	320
2.2 TDCi	2.179	147	4	07.2010-01.2015	KNBA	; Position: Intake Manifold	EPBBPN3-A018Z	95753	35	320
2.5	2.521	162	5	03.2007-01.2015	HUBA		EPBBPT4-V009Z	95675	20	300

MONDEO V (CD, CE, CF)

1.0 EcoBoost	998	92	3	02.2015-	M1CB		EPBMPT4-V028Z	93902	11,2	250
1.5 EcoBoost	1.499	118	4	09.2014-	UNCA, UNCB, UNCE, UNCF		EPBMPT4-V028Z	93902	11,2	250
1.5 EcoBoost	1.499	121	4	05.2018-	UNCN		EPBMPT4-V028Z	93902	11,2	250
1.6 TDCi	1.560	85	4	09.2014-	NGCA, U3CA	; Position: Suction Pipe	EPBMBT4-A003Z	93024	12,9	316,5
2.0 Hybrid	1.999	130	4	09.2014-	C20EDEF		EPBMPT4-A017Z	96798	10	115
2.0 Hybrid	1.999	140	4	09.2014-	UACA		EPBMPT4-A017Z	96798	10	115
2.0 EcoBoost	1.999	146	4	05.2015-	TNCC		EPBMPN3-V019Z	93061	10	307,5
2.0 EcoBoost	1.999	149	4	09.2014-	TNCD	; Position: Intake Manifold	EPBMPN3-V019Z	93061	10	307,5
2.0 EcoBoost	1.999	149	4	09.2014-	TNCF		EPBMPN3-V019Z	93061	10	307,5
2.0 EcoBoost	1.999	176	4	09.2014-	R9CB, R9CF, R9CH		EPBMPN3-V019Z	93061	10	307,5

P 100 II

2.0	1.993	57	4	10.1987-12.1992	NAE	; Germany	EPBMPN3-D029Z	95772	15	115
-----	-------	----	---	-----------------	-----	------------	---------------	-------	----	-----

RANGER (ET)

2.5 TDCi 4x4	2.499	105	4	05.2006-07.2012	WLAA		EPBBPT4-V001Z	92565	11	307
3.0 TDCi	2.953	115	4	05.2006-07.2012	MD30DITC		EPBBPT4-V001Z	92565	11	307
3.0 TDCi 4x4	2.953	115	4	05.2006-07.2012	WEC		EPBBPT4-V001Z	92565	11	307

RANGER (TKE)

2.2 TDCi	2.198	88	4	04.2011-	GBVAJPF	; Position: Suction Pipe	EPBMPN3-V019Z	93061	10	307,5
2.2 TDCi	2.198	92	4	04.2011-	GBVAJQW	; Position: Suction Pipe	EPBMPN3-V019Z	93061	10	307,5
2.2 TDCi 4x4	2.198	92	4	04.2011-	GBVAJQW	; Position: Suction Pipe	EPBMPN3-V019Z	93061	10	307,5
2.2 TDCi	2.198	110	4	11.2011-	GBVAJQJ	; Position: Suction Pipe	EPBMPN3-V019Z	93061	10	307,5
2.2 TDCi 4x4	2.198	110	4	04.2011-	GBVAJQJ	; Position: Suction Pipe	EPBMPN3-V019Z	93061	10	307,5
3.2 TDCi 4x4	3.198	147	5	04.2011-	SAFA	; Position: Suction Pipe	EPBMPN3-V019Z	93061	10	307,5

SCORPIO II (GFR, GGR, GNR)

2.5 TD	2.500	92	4	09.1996-08.1998	VM		EPBBPN3-A022Z	92949	20	250
--------	-------	----	---	-----------------	----	--	---------------	-------	----	-----

S-MAX (CJ)

1.5 EcoBoost	1.498	118	4	01.2015-06.2018	UNCI, UNCJ, UNCK		EPBMPT4-V028Z	93902	11,2	250
2.0 EcoBoost	1.999	176	4	01.2015-	R9CD, R9CI		EPBMPN3-V019Z	93061	10	307,5



MAP



l kW
C
Y
I



Type-N°

Stock-N°

kPa from
kPa to

FORD

S-MAX (WA6)

1.6 TDCi	1.560	85	4	02.2011-12.2014	T1WA	; Position: Intake Manifold	EPBMBT4-A003Z	93024	12,9	316,5
1.6 EcoBoost	1.596	118	4	02.2011-12.2014	JTWA, JTWB		EPBMPN3-V019Z	93061	10	307,5
1.8 TDCi	1.753	74	4	-03.2010	FFWA		EPBBPN3-V021Z	95679	20	300
1.8 TDCi	1.753	92	4	05.2006-12.2014	QYWA		EPBBPN3-V021Z	95679	20	300
2.0 TDCi	1.997	100	4	05.2006-12.2014	UKWA	; Position: Intake Manifold	EPBMBT4-A003Z	93024	12,9	316,5
2.0 TDCi	1.997	120	4	03.2010-12.2014	TXWA	; Position: Intake Manifold	EPBMBT4-A003Z	93024	12,9	316,5
2.0	1.999	107	4	05.2006-12.2014	AOWA, AOWB, TBWA, TBWB		EPBMPT4-A017Z	96798	10	115
2.0 Flexifuel	1.999	107	4	05.2006-12.2014	TBWA, TBWB		EPBMPT4-A017Z	96798	10	115
2.0 EcoBoost	1.999	146	4	07.2010-12.2014	TNWB		EPBMPN3-V019Z	93061	10	307,5
2.0 EcoBoost	1.999	149	4	03.2010-12.2014	TNWA		EPBBPT4-V009Z	95675	20	300
2.0 EcoBoost	1.999	176	4	07.2010-12.2014	TPWA		EPBMPN3-V019Z	93061	10	307,5
2.0 EcoBoost	1.999	176	4	07.2010-12.2014	TPWA		EPBBPT4-V009Z	95675	20	300
2.2 TDCi	2.179	129	4	03.2008-12.2012	Q4WA	; Position: Intake Manifold	EPBBPN3-A018Z	95753	35	320
2.2 TDCi	2.179	147	4	07.2010-12.2014	KNWA	; Position: Intake Manifold	EPBBPN3-A018Z	95753	35	320
2.5 ST	2.521	162	5	05.2006-12.2014	HUWA		EPBBPT4-V009Z	95675	20	300

STREET KA (RL2)

1.6	1.599	70	4	05.2003-07.2005	CDRA, CDRB		EPBMPT4-A007Z	96755	10	120
-----	-------	----	---	-----------------	------------	--	---------------	-------	----	-----

TOURNEO CONNECT

1.8 TDCi, TDDi, DI	1.753	55	4	06.2002-12.2013	BHPA, P7PA, P7PB, R2PA		EPBMPN3-V008Z	90549	40	250
1.8 TDCi, TDDi, DI	1.753	55	4	06.2002-12.2013	BHPA, P7PA, P7PB, R2PA		EPBBPN3-A031Z	95922	40	250
1.8 TDCi	1.753	66	4	06.2002-12.2013	HCPA, HCPB, HCPC, HCPD, P9PA, P9PB, P9PC, P9PD, R3PA, RWPE, RWPFF		EPBMPN3-V008Z	90549	40	250
1.8 TDCi	1.753	81	4	08.2006-12.2013	RWPA, RWPB, RWPC, RWPD		EPBMPN3-V008Z	90549	40	250
1.8 16V	1.796	85	4	06.2002-12.2013	EYPA, EYPB, EYPC, EYPD		EPBMPN3-A003Z	92477	15	102

TOURNEO CONNECT / GRAND TOURNEO CONNECT (V408)

1.0 EcoBoost	998	74	3	11.2013-	M2GA, M2GB		EPBMPN3-V019Z	93061	10	307,5
1.6 TDCi	1.560	55	4	09.2013-	UBGA		EPBMBT4-A003Z	93024	12,9	316,5
1.6 TDCi	1.560	70	4	09.2013-	TZGA		EPBMBT4-A003Z	93024	12,9	316,5
1.6 EcoBoost	1.596	110	4	11.2013-	JQGA		EPBMPN3-V019Z	93061	10	307,5

TOURNEO COURIER (B460)

1.0 EcoBoost	998	74	3	02.2014-	SFCA, SFGB, SFCC, SFCD, SFCE, SFCF		EPBMPN3-V019Z	93061	10	307,5
1.6 TDCi	1.560	70	4	02.2014-	T3CA		EPBMBT4-A003Z	93024	12,9	316,5
1.5 TDCi	1.499	55	4	02.2014-	UGCA, UGCB, XUCC, XUCD		EPBBPN3-A017Z	95311	35	320

TOURNEO CUSTOM (V362)

2.2 TDCi	2.198	74	4	04.2012-	DRFG, DRFF, DRF4		EPBMPN3-V019Z	93061	10	307,5
2.2 TDCi	2.198	92	4	04.2012-	CYF4, CYFF		EPBMPN3-V019Z	93061	10	307,5
2.2 TDCi	2.198	114	4	04.2012-	CVFF		EPBMPN3-V019Z	93061	10	307,5



MAP



l kW
C
Y
I



Type-N°

Stock-N°

kPa from

kPa to

FORD TRANSIT (E_ _)

2.5 TD	2.496	55	4	-09.1997	4HA, 4HD		EPBBPN3-A026Z	96088	40	250
2.5 TD	2.496	55	4	09.1997-	4HA, 4HD		EPBBPN3-A032Z	96503	50	250
2.5 TD	2.496	63	4	-09.1997	4GA, 4GB, 4GC, 4GD, 4GE, 4GF		EPBBPN3-A026Z	96088	40	250
2.5 TD	2.496	63	4	09.1997-	4GA, 4GB, 4GC, 4GD, 4GE, 4GF		EPBBPN3-A032Z	96503	50	250
2.5 DI	2.496	63	4	10.1992-06.1994	4GA		EPBBPN3-A026Z	96088	40	250
2.5 DI	2.496	63	4	10.1992-06.1994	4GA		EPBBPN3-A032Z	96503	50	250
2.5 TD	2.496	63	4	10.1992-07.1994	4GA, 4GB, 4GC		EPBBPN3-A026Z	96088	40	250
2.5 TD	2.496	63	4	10.1992-07.1994	4GA, 4GB, 4GC		EPBBPN3-A032Z	96503	50	250
2.5 TD	2.496	74	4	-09.1997	4EB, 4EC		EPBBPN3-A026Z	96088	40	250
2.5 TD	2.496	74	4	09.1997-	4EB, 4EC		EPBBPN3-A032Z	96503	50	250
2.5 TD	2.496	74	4	05.1991-06.1994	4EA		EPBBPN3-A026Z	96088	40	250
2.5 TD	2.496	74	4	05.1991-06.1994	4EA		EPBBPN3-A032Z	96503	50	250
2.5 DI	2.496	85	4	-09.1997	4ED		EPBBPN3-A026Z	96088	40	250
2.5 DI	2.496	85	4	09.1997-	4ED		EPBBPN3-A032Z	96503	50	250
2.9 i	2.935	107	6	-02.1992	BRT		EPBMPN3-D029Z	95772	15	115

TRANSIT (FA_ _ , FM_ _ , FN_ _ , FF_ _ , FD_ _ , FB_ _ , FS_ _ , FZ_ _ , FC_ _)

2.4 DI, 2.4 DI RWD	2.402	55	4	01.2000-05.2006	F4FA		EPBMPT4-V002Z	94153	40	261
2.4 TDDi	2.402	66	4	10.2001-03.2006	D2FE		EPBMPT4-V002Z	94153	40	261
2.4 DI	2.402	66	4	01.2000-05.2006	D2FA, D2FB	; Position: Intake Manifold	EPBMPT4-V002Z	94153	40	261
2.4 TDCi, 2.4 TDCi RWD	2.402	74	4	04.2006-08.2014	PHFA, PHFC		EPBBPT4-A011Z	94601	20	300
2.4 TDE	2.402	85	4	03.2004-05.2006	FXFA		EPBMPT4-V002Z	94153	40	261
2.3 16V LPG RWD	2.261	107	4	-09.2011	GZFC		EPBMPT4-A017Z	96798	10	115
2.0 DI	1.998	55	4	08.2000-05.2006	D3FA		EPBMPT4-V002Z	94153	40	261
2.0 DI	1.998	63	4	08.2000-05.2006	F3FA		EPBMPT4-V002Z	94153	40	261
2.0 DI	1.998	74	4	08.2000-05.2006	ABFA		EPBMPT4-V002Z	94153	40	261
2.0 TDCi	1.998	92	4	08.2002-05.2006	F1FA		EPBMPT4-V002Z	94153	40	261
2.2 TDCi	2.198	63	4	04.2006-08.2014	P8FA, P8FB		EPBBPT4-A011Z	94601	20	300
2.2 TDCi	2.198	63	4	04.2006-08.2014	P8FA, P8FB		EPBMPT4-A017Z	96798	10	115
2.2 TDCi, 2.2 TDCi RWD	2.198	74	4	10.2011-08.2014	DRFA, DRFB, DRFC, DRFD, DRFE		EPBMPN3-V019Z	93061	10	307,5
2.2 TDCi	2.198	81	4	04.2006-08.2014	QVFA		EPBBPT4-A011Z	94601	20	300
2.2 TDCi	2.198	85	4	10.2008-08.2014	SRFA, SRFB, SRFC, SRFD, SRFE		EPBBPT4-A011Z	94601	20	300
2.2 TDCi	2.198	92	4	10.2011-08.2014	CYFA, CYFB, CYFC, CYFD		EPBMPN3-V019Z	93061	10	307,5
2.2 TDCi RWD	2.198	92	4	09.2011-12.2014	CYRA		EPBMPN3-V019Z	93061	10	307,5
2.2 TDCi RWD	2.198	92	4	09.2011-12.2014	CYRB	; Position: Intake Manifold	EPBMPN3-V019Z	93061	10	307,5
2.2 TDCi 4x4	2.198	92	4	10.2011-08.2014	CYRB, CYRC		EPBMPN3-V019Z	93061	10	307,5
2.2 TDCi	2.198	96	4	04.2006-08.2014	QWFA		EPBBPT4-A011Z	94601	20	300
2.2 TDCi RWD	2.198	100	4	10.2011-08.2014	USRA, USRB		EPBMPN3-V019Z	93061	10	307,5



MAP



l kW
C
Y
I



Type-N°

Stock-N°

kPa from
kPa to

FORD

TRANSIT (FA_, FM_, FN_, FF_, FD_, FB_, FS_, FZ_, FC_)

2.2 TDCi	2.198	103	4	10.2007-08.2014	PGFA, PGFB		EPBBPT4-A011Z	94601	20	300
2.2 TDCi	2.198	103	4	10.2007-09.2011	UHFA, UHFB, UHFC		EPBMPN3-V019Z	93061	10	307,5
2.2 TDCi RWD	2.198	114	4	10.2011-08.2014	CVRA, CVRB, CVRC		EPBMPN3-V019Z	93061	10	307,5
2.3 16V CNG RWD	2.261	100	4	-09.2011	GZFC		EPBMPT4-A017Z	96798	10	115
2.3	2.295	105	4	03.2001-03.2006	E5FC		EPBMPT4-V002Z	94153	40	261
2.3	2.295	105	4	03.2001-03.2006	E5FC		EPBMPN3-A003Z	92477	15	102
2.3 16V RWD	2.261	107	4	04.2006-08.2014	GZFA, GZFB, GZFC		EPBMPT4-A017Z	96798	10	115
2.3	2.295	107	4	08.2000-03.2006	E5FA		EPBMPT4-V002Z	94153	40	261
2.3 16V, 2.3 16V RWD	2.295	107	4	08.2000-05.2006	E5FA, E5FC		EPBMPN3-A003Z	92477	15	102
2.3 16V, 2.3 16V RWD	2.295	107	4	08.2000-05.2006	E5FA, E5FC		EPBMPT4-V002Z	94153	40	261
2.3	2.295	107	4	03.2001-03.2006	E5FA		EPBMPN3-A003Z	92477	15	102
2.4 TDCi, 2.4 TDCi RWD	2.402	85	4	04.2006-08.2014	JXFA, JXFC		EPBBPT4-A011Z	94601	20	300
2.4 DI, 2.4 DI RWD	2.402	88	4	01.2000-05.2006	D4FA		EPBMPT4-V002Z	94153	40	261
2.4 TDE	2.402	92	4	07.2001-05.2006	DOFA		EPBMPT4-V002Z	94153	40	261
2.4 TDCi	2.402	101	4	03.2004-05.2006	H9FA		EPBMPT4-V002Z	94153	40	261
2.4 TDCi	2.402	103	4	04.2006-08.2014	H9FD		EPBBPT4-A011Z	94601	20	300
2.4 TDCi 4x4	2.402	103	4	11.2006-08.2014	H9FB		EPBBPT4-A011Z	94601	20	300
2.4 TDCi RWD	2.402	103	4	04.2006-08.2014	H9FB, H9FD		EPBBPT4-A011Z	94601	20	300
3.2 TDCi	3.199	147	5	02.2008-08.2014	SAFA, SAFB		EPBBPT4-A011Z	94601	20	300
3.2 TDCi RWD	3.199	147	5	09.2007-08.2014	SAFA, SAFB		EPBBPT4-A011Z	94601	20	300

TRANSIT (T_)

1.6	1.593	46	4	-12.1988	LAT	: Germany	EPBMPN3-D029Z	95772	15	115
2.0	1.993	56	4	-12.1988	NAW	: Germany	EPBMPN3-D029Z	95772	15	115
2.0	1.994	57	4	-12.1988	NAT, NAV	: Germany	EPBMPN3-D029Z	95772	15	115
2.0 Cat	1.993	57	4	-12.1988	N6T	: Germany	EPBMPN3-D029Z	95772	15	115

TRANSIT CONNECT (P65_, P70_, P80_)

1.8 Di	1.753	55	4	06.2002-12.2013	BHPA, P7PA, P7PB, R2PA		EPBMPN3-V008Z	90549	40	250
1.8 Di	1.753	55	4	-07.2006	BHPA, P7PA, P7PB, R2PA		EPBBPN3-A031Z	95922	40	250
1.8 TDCi	1.753	66	4	06.2002-12.2013	HCPA, HCPB, HCPC, HCPD, P9PA, P9PB, P9PC, P9PD, R3PA, RWPE, RWPF		EPBMPN3-V008Z	90549	40	250
1.8 TDCi	1.753	81	4	08.2006-12.2013	RWPA, RWPB, RWPC, RWPD		EPBMPN3-V008Z	90549	40	250
1.8 16V	1.796	85	4	06.2002-12.2013	EYPA, EYPC, EYPD		EPBMPN3-A003Z	92477	15	102
1.8 16V LPG	1.796	85	4	06.2002-12.2013	EYPA, EYPC, EYPD		EPBMPN3-A003Z	92477	15	102

TRANSIT CONNECT (V403)

1.0 EcoBoost	998	74	3	02.2013-	M2GA, M2GA/M2GB, M2GB, M2GA/M2GB		EPBMPN3-V019Z	93061	10	307,5
1.6 TDCi	1.560	55	4	02.2013-	UBGA		EPBMBT4-A003Z	93024	12,9	316,5
1.6 TDCi	1.560	70	4	02.2013-	TZGA		EPBMBT4-A003Z	93024	12,9	316,5



MAP



l kW
C
Y
I



Type-Nº

Stock-Nº

kPa from

kPa to

FORD

TRANSIT CONNECT (V408)

1.6 TDCi	1.560	85	4	02.2013-	T1GA		EPBMBT4-A003Z	93024	12,9	316,5
1.6 EcoBoost	1.596	110	4	11.2013-	JQGA		EPBMPN3-V019Z	93061	10	307,5

TRANSIT CONNECT ESTATE

1.6 TDCi	1.560	55	4	02.2013-	UBGA		EPBMBT4-A003Z	93024	12,9	316,5
1.6 TDCi	1.560	70	4	02.2013-	TZGA		EPBMBT4-A003Z	93024	12,9	316,5
1.6 TDCi	1.560	85	4	02.2013-	T1GA		EPBMBT4-A003Z	93024	12,9	316,5

TRANSIT COURIER (B460)

1.0 EcoBoost	998	74	3	02.2014-	SFCA, SFCB, SFCC, SFCD, SFCE, SFCF		EPBMPN3-V019Z	93061	10	307,5
1.5 TDCi	1.499	55	4	02.2014-	UGCA, UGCB, XUCC, XUCD		EPBBPN3-A017Z	95311	35	320
1.6 TDCi	1.560	70	4	02.2014-	T3CA		EPBMBT4-A003Z	93024	12,9	316,5

TRANSIT CUSTOM V362 (F3, FY, FZ)

1.0 EcoBoost PHEV	998	92	3	09.2019-	M1FA		EPBMPN3-V019Z	93061	10	307,5
2.2 TDCi	2.198	74	4	04.2012-	DRFF, DRFG, DRF4		EPBMPN3-V019Z	93061	10	307,5
2.2 TDCi	2.198	92	4	04.2012-	CYF4, CYFF		EPBMPN3-V019Z	93061	10	307,5
2.2 TDCi	2.198	114	4	04.2012-	CVFF		EPBMPN3-V019Z	93061	10	307,5

TRANSIT TOURNEO

2.2 TDCi	2.198	85	4	10.2008-08.2014	SRFA, SRFB, SRFC, SRFD, SRFE		EPBBPT4-A011Z	94601	20	300
2.2	2.198	92	4	10.2011-08.2014	CYFA, CYFB		EPBMPN3-V019Z	93061	10	307,5
2.2 TDCi	2.198	96	4	07.2006-08.2014	QWFA		EPBBPT4-A011Z	94601	20	300
2.2 TDCi	2.198	103	4	10.2007-08.2014	PGFA, PGFB, UHFA, UHFB, UHFC		EPBBPT4-A011Z	94601	20	300
2.2 TDCi	2.198	103	4	10.2007-08.2014	PGFA, PGFB	; Position: Intake Manifold	EPBMPN3-V019Z	93061	10	307,5
2.4 D	2.496	55	4	-09.1997	4HA		EPBBPN3-A026Z	96088	40	250
2.4 D	2.496	55	4	09.1997-	4HA		EPBBPN3-A032Z	96503	50	250
2.5 DI	2.496	56	4	-09.1997	4HA		EPBBPN3-A026Z	96088	40	250
2.5 DI	2.496	56	4	09.1997-	4HA		EPBBPN3-A032Z	96503	50	250
2.5 TD	2.496	63	4	-09.1997	4GA, 4GB, 4GC		EPBBPN3-A026Z	96088	40	250
2.5 TD	2.496	63	4	09.1997-	4GA, 4GB, 4GC		EPBBPN3-A032Z	96503	50	250
2.5 TD	2.496	74	4	04.1998-12.2000	4EB, 4EC		EPBBPN3-A032Z	96503	50	250

TRANSIT TOURNEO (FC_ _)

2.0	1.998	55	4	06.2000-08.2003	D3FA		EPBMPT4-V002Z	94153	40	261
2.0	1.998	74	4	06.2000-03.2005	ABFA		EPBMPT4-V002Z	94153	40	261
2.0	1.998	92	4	03.2002-03.2006	FIFA		EPBMPT4-V002Z	94153	40	261

TRANSIT V363 (FAD, FBD, FED, FFD, FCD, FDD)

2.2 TDCi	2.198	74	4	08.2013-	DRF5, DRFG, DRFF		EPBMPN3-V019Z	93061	10	307,5
2.2 TDCi RWD	2.198	74	4	08.2013-	DRR5		EPBMPN3-V019Z	93061	10	307,5
2.2 TDCi	2.198	92	4	08.2013-	CYF5, CYFG		EPBMPN3-V019Z	93061	10	307,5
2.2 TDCi	2.198	92	4	08.2013-	CY14	; Position: Intake Manifold	EPBMPN3-V019Z	93061	10	307,5
2.2 TDCi	2.198	92	4	08.2013-	USF6	; Position: Intake Manifold	EPBMPN3-V019Z	93061	10	307,5



MAP



l kW
C
Y
I



Type-N°

Stock-N°

kPa from
kPa to

FORD

TRANSIT V363 (FAD, FBD, FED, FFD, FCD, FDD)

2.2 TDCi 4x4	2.198	92	4	08.2013-	CYR5		EPBMPN3-V019Z	93061	10	307,5
2.2 TDCi 4x4	2.198	92	4	08.2013-	CY24	; Position: Intake Manifold	EPBMPN3-V019Z	93061	10	307,5
2.2 TDCi RWD	2.198	92	4	08.2013-	USR6, CYR5		EPBMPN3-V019Z	93061	10	307,5
2.2 TDCi RWD	2.198	99	4	08.2013-	UHR5		EPBMPN3-V019Z	93061	10	307,5
2.2 TDCi	2.198	114	4	08.2013-	CVF5		EPBMPN3-V019Z	93061	10	307,5
2.2 TDCi RWD	2.198	114	4	08.2013-	CVR5, UYR6		EPBMPN3-V019Z	93061	10	307,5
2.2 TDCi RWD	2.198	114	4	08.2013-	CV24	; Position: Intake Manifold	EPBMPN3-V019Z	93061	10	307,5
2.2 TDCi 4x4	2.198	114	4	08.2015-	CVR5		EPBMPN3-V019Z	93061	10	307,5
2.2 TDCi 4x4	2.198	114	4	08.2015-	CV24	; Position: Intake Manifold	EPBMPN3-V019Z	93061	10	307,5

GEELY

BL

1.3	1.342	63	4	09.2005-	8A, MR479Q		EPBMPT4-V043Z	97765	20	115
1.5	1.498	69	4	09.2005-	5A-FE, MR479QA		EPBMPT4-D025Z	92358	17	115

HONDA

ACCORD V (CC, CE, CF_, CD)

1.9 i	1.850	85	4	02.1996-10.1998	F18A3		EPBMPN3-R046Z	95625	10	160
2.0 Tdi	1.994	77	4	04.1996-10.1998	20T2N		EPBBPN3-A022Z	92949	20	250
2.0 i	1.997	85	4	01.1994-	F20Z2		EPBMPN3-R046Z	95625	10	160
2.0 i S	1.997	96	4	01.1994-	F20Z1		EPBMPN3-R046Z	95625	10	160
2.0 i LS	1.997	96	4	02.1996-10.1998	F20Z1		EPBMPN3-R046Z	95625	10	160
2.0 i LS 16V	1.997	100	4	09.1993-02.1998	F20B3		EPBMPN3-R012Z	96590	10	170
2.2 i VTEC	2.156	110	4	02.1996-10.1998	F22Z2		EPBMPN3-R012Z	96590	10	170
2.2 i ES	2.156	110	4	09.1993-02.1998	F22B5		EPBMPN3-R012Z	96590	10	170
2.3 i SR	2.259	116	4	-01.1993	H23A3		EPBMPN3-R046Z	95625	10	160

ACCORD VI (CK, CG, CH, CF, CL)

1.6 LS	1.590	79	4	10.1998-12.2002	D16B7		EPBMPN3-A034Z	92094	20	115
1.6 i	1.590	85	4	10.1998-12.2002	D16B6		EPBMPN3-A034Z	92094	20	115
1.8 i	1.850	100	4	12.1999-12.2002	F18B2, F18B4		EPBMPN3-R012Z	96590	10	170
2.0 Turbo DI, 2.0 Tdi	1.994	77	4	02.1999-12.2002	20T2N		EPBBPN3-A022Z	92949	20	250
2.0 Turbo DI, 2.0 Tdi	1.994	77	4	02.1999-12.2002	20T2N		EPBBPN3-A028Z	93277	20	200
2.0 i 16V	1.997	108	4	02.1998-06.2003	F20B5, F20B6, F20B7		EPBMPN3-R012Z	96590	10	170
2.2 Type-R	2.157	156	4	02.1999-12.2002	H22A7		EPBMPN3-R012Z	96590	10	170
2.3	2.254	113	4	11.2000-06.2003	F23A1, F23Z5		EPBMPN3-R012Z	96590	10	170
3.0 V6 24V	2.997	147	6	02.1998-06.2003	J30A1		EPBMPN3-R012Z	96590	10	170

ACCORD VII (CL, CN, CM, CN)

2.0, 2.0 All-wheel Drive	1.998	114	4	02.2003-05.2008	K20A6		EPBMPN3-A015Z	94611	10	165
2.2 i-CTDi	2.204	103	4	01.2004-05.2008	N22A1		EPBBPT4-V001Z	92565	11	307



MAP



l kW
C
Y
I



Type-Nº

Stock-Nº

kPa from

kPa to

HONDA

ACCORD VII (CL, CN, CM, CN)

2.4	2,354	140	4	02.2003-05.2008	K24A, K24A3		EPBMPN3-A015Z	94611	10	165
-----	-------	-----	---	-----------------	-------------	--	---------------	-------	----	-----

ACCORD VIII (CU, CW)

2.2 i-DTEC	2,199	110	4	07.2008-	N22B1		EPBBPT4-V001Z	92565	11	307
2.2 i-DTEC	2,199	132	4	07.2008-	N22B2		EPBBPT4-V001Z	92565	11	307

CITY SALOON (GE4) | FIT ARIA

1.3	1,339	60	4	10.2005-07.2008	L13A3		EPBMPN3-A015Z	94611	10	165
-----	-------	----	---	-----------------	-------	--	---------------	-------	----	-----

CIVIC V (EG, EH, EJ)

1.5 i 16V	1,493	66	4	01.1994-	D15B2		EPBMPN3-R046Z	95625	10	160
1.5 i 16V	1,493	69	4	01.1994-	D15B2		EPBMPN3-R046Z	95625	10	160
1.5 i 16V	1,493	69	4	10.1991-11.1995	D15Z1		EPBMPN3-R012Z	96590	10	170
1.5 i Lsi	1,493	74	4	08.1993-11.1995	D15B7		EPBMPN3-R012Z	96590	10	170
1.6 i Vtec	1,590	92	4	01.1994-03.1996	D16Y6, D16Z9		EPBMPN3-R012Z	96590	10	170
1.6 16V Vtec	1,590	92	4	10.1991-11.1995	D16Z6		EPBMPN3-R012Z	96590	10	170
1.6 VTi 16V	1,595	118	4	10.1991-11.1995	B16A2		EPBMPN3-R012Z	96590	10	170

CIVIC VI (EJ, EK, EM1, MA, MB, MC)

1.4 i	1,396	55	4	04.1998-02.2001	D14A3, D14A5, D14A7, D14Z1, D14Z3		EPBMPN3-R012Z	96590	10	170
1.4 i	1,396	66	4	04.1998-02.2001	D14A2, D14A4, D14A6, D14A8, D14Z2, D14Z4		EPBMPN3-R012Z	96590	10	170
1.5 i Vtec-E	1,493	66	4	09.1994-01.1997	D15Z3		EPBMPN3-R012Z	96590	10	170
1.5 16V	1,493	84	4	01.1997-02.2001	D15Z8		EPBMPN3-R012Z	96590	10	170
1.5 i	1,493	84	4	11.1995-02.2001	D15Z6		EPBMPN3-R012Z	96590	10	170
1.6 i	1,590	77	4	03.1996-03.2000	D16Y7		EPBMPN3-R012Z	96590	10	170
1.6 i	1,590	83	4	09.1994-01.1997	D16Y3		EPBMPN3-R012Z	96590	10	170
1.6 i	1,590	84	4	11.1995-02.2001	D16Y5		EPBMPN3-R012Z	96590	10	170
1.6 16V	1,590	85	4	01.1997-02.2001	D16B2		EPBMPN3-R012Z	96590	10	170
1.6 i Vtec	1,590	92	4	11.1995-02.2001	D16Y6, D16Y8		EPBMPN3-R012Z	96590	10	170
1.6 i Vtec	1,590	93	4	09.1994-01.1997	D16Y2		EPBMPN3-R012Z	96590	10	170
1.6 i Vtec	1,595	118	4	04.1999-12.2000	B16A2		EPBMPN3-R012Z	96590	10	170
1.6 VTi	1,595	118	4	11.1995-02.2001	B16A2		EPBMPN3-R012Z	96590	10	170
1.8 16V	1,797	124	4	01.1997-02.2001	B18C4		EPBMPN3-R012Z	96590	10	170
2.0 i TD	1,994	63	4	01.1997-02.2001	20T2R		EPBBPN3-A022Z	92949	20	250
2.0 TDiC	1,994	74	4	-12.1999	20T2N		EPBBPN3-A022Z	92949	20	250
2.0 i D, 2.0 TDiC	1,994	77	4	-12.1999	20T2N		EPBBPN3-A022Z	92949	20	250

CIVIC VII (EM2, EU, EP, EV, ES, ET)

1.3 IMA	1,339	61	4	10.2003-09.2005	LDA1		EPBMPN3-A015Z	94611	10	165
1.4 i	1,396	55	4	02.2001-09.2005	D14Z6		EPBMPN3-A015Z	94611	10	165
1.4 iS	1,396	66	4	12.2000-09.2005	D14Z5, D14Z6		EPBMPN3-A015Z	94611	10	165
1.6 i	1,590	81	4	02.2001-12.2005	D16V1, D16W7		EPBMPN3-A015Z	94611	10	165



MAP

 kW
C
Y
I

Type-N°

Stock-N°

 kPa from
kPa to

HONDA
CIVIC VII (EM2, EU, EP, EV, ES, ET)

1.7	1.668	85	4	02.2001-09.2005	D17A6		EPBMPN3-A015Z	94611	10	165
1.7 i	1.668	88	4	05.2001-12.2005	D17A8		EPBMPN3-A015Z	94611	10	165
1.7 i VTEC	1.668	92	4	05.2001-12.2005	D17A5, D17A9		EPBMPN3-A015Z	94611	10	165
1.7 CTDi	1.686	74	4	01.2002-09.2005	4EE-2		EPBBPN3-V010Z	95936	20	250
2.0 i Sport	1.998	118	4	09.2001-09.2005	K20A3		EPBMPN3-A015Z	94611	10	165
2.0 Type-R	1.998	147	4	09.2001-09.2005	K20A2		EPBMPN3-A015Z	94611	10	165

CIVIC VIII (FD, FA, FN, FK)

1.3 Hybrid	1.339	70	4	01.2006-	LDA2		EPBMPN3-A015Z	94611	10	165
1.3 Hybrid	1.339	85	4	01.2010-02.2012	LDA2		EPBMPN3-A015Z	94611	10	165
1.4	1.339	61	4	09.2005-	L13A7		EPBMPN3-A015Z	94611	10	165
2.2 CTDi	2.204	103	4	09.2005-	N22A2		EPBBPT4-V001Z	92565	11	307

CR-V I (RD)

2.0 16V 4WD	1.973	94	4	10.1995-12.2001	B20B		EPBMPN3-R012Z	96590	10	170
2.0 16V 4WD	1.973	108	4	01.1999-02.2002	B20Z1		EPBMPN3-R012Z	96590	10	170

CR-V II (RD_)

2.0	1.998	110	4	09.2001-03.2007	K20A4		EPBMPN3-A015Z	94611	10	165
2.2 CTDi	2.204	103	4	02.2005-09.2006	N22A2		EPBBPT4-V001Z	92565	11	307
2.4 Vtec 4WD	2.354	118	4	09.2001-09.2006	K24A1		EPBMPN3-A015Z	94611	10	165

CR-V III (RE_)

2.2 i-CTDi 4WD	2.204	103	4	01.2007-	N22A2		EPBBPT4-V001Z	92565	11	307
2.2 i-DTEC 4WD	2.199	110	4	01.2007-	N22B3		EPBBPT4-V001Z	92565	11	307

CRX III (EH, EG)

1.6 Esi	1.590	92	4	03.1992-12.1998	D16Y8, D16Z6		EPBMPN3-R012Z	96590	10	170
1.6 i Vti	1.595	118	4	03.1992-12.1998	B16A2		EPBMPN3-R012Z	96590	10	170

FR-V (BE)

1.7	1.668	92	4	08.2004-	D17A2		EPBMPN3-A015Z	94611	10	165
2.0	1.998	110	4	02.2005-	K20A9		EPBMPN3-A015Z	94611	10	165
2.2 i CTDi	2.204	103	4	07.2005-	N22A1		EPBBPT4-V001Z	92565	11	307

HR-V (GH)

1.0 Hybrid	995	56	3	04.2000-12.2006	ECA1		EPBMPN3-R046Z	95625	10	160
1.6 16V 4WD	1.590	77	4	03.1999-	D16W1		EPBMPN3-R012Z	96590	10	170
1.6 16V	1.590	77	4	03.1999-	D16W1		EPBMPN3-R012Z	96590	10	170
1.6 16V 4WD	1.590	91	4	10.1999-	D16W5		EPBMPN3-R012Z	96590	10	170

INTEGRA (DC2, DC4)

1.8 Type-R	1.797	140	4	11.1997-10.2001	B18C6		EPBMPN3-R012Z	96590	10	170
------------	-------	-----	---	-----------------	-------	--	---------------	-------	----	-----

JAZZ II (GD_, GE3, GE2)

1.2 i-DSI	1.243	57	4	03.2002-07.2008	L12A1, L12A4		EPBMPN3-A015Z	94611	10	165
1.2 i-DSI	1.243	57	4	03.2002-08.2008	L12A1, L12A4		EPBMPT4-V038Z	94727		
1.3 iDSi	1.339	61	4	03.2002-07.2008	L13A1	; Japan	EPBMPN3-A015Z	94611	10	165



MAP



l kW
C
Y
I



Type-N°

Stock-N°

kPa from

kPa to

HONDA

JAZZ II (GD_, GE3, GE2)

1.3 iDSi	1.339	61	4	03.2002-08.2008	L13A1		EPBMP4-V038Z	94727		
1.4 iDSi	1.339	61	4	12.2006-10.2008	L13A6	;	EPBMP3-A015Z	94611	10	165

JAZZ III (GE_, GG_, GP_, ZA_)

1.3 i	1.339	73	4	07.2008-	L13Z1, L13Z2		EPBMP3-A015Z	94611	10	165
-------	-------	----	---	----------	--------------	--	--------------	-------	----	-----

LEGEND III (KA)

3.5 i 24V	3.474	151	6	02.1996-10.1997	C35A2		EPBMP3-R046Z	95625	10	160
-----------	-------	-----	---	-----------------	-------	--	--------------	-------	----	-----

LEGEND IV (KB_)

3.5 V6 4WD	3.471	217	6	05.2006-12.2012	J35A8		EPBMP3-A015Z	94611	10	165
------------	-------	-----	---	-----------------	-------	--	--------------	-------	----	-----

LOGO (GA)

1.3	1.343	48	4	03.1999-03.2002	D13B7		EPBMP3-R012Z	96590	10	170
-----	-------	----	---	-----------------	-------	--	--------------	-------	----	-----

NSX I (NA)

3.0 24V Vtec Automatic	2.977	188	6	01.1997-	C30A4		EPBMP3-R046Z	95625	10	160
3.2 24V Vtec	3.179	206	6	01.1997-09.2005	C32B2		EPBMP3-R046Z	95625	10	160

PRELUDE IV (BB_)

2.0 i 16V	1.997	98	4	01.1994-	F20A4		EPBMP3-R046Z	95625	10	160
2.2 i 16V Vtec	2.157	136	4	01.1994-	H22A2		EPBMP3-R046Z	95625	10	160
2.3 i 16V	2.259	118	4	01.1994-	H23A2		EPBMP3-R046Z	95625	10	160

PRELUDE V (BB_)

2.0 16V	1.997	98	4	10.1996-10.2000	F20A4		EPBMP3-R012Z	96590	10	170
2.2 16V	2.157	136	4	10.1996-10.2000	H22A2, H22A5		EPBMP3-R012Z	96590	10	170
2.2 16V	2.157	147	4	10.1996-10.2000	H22A4, H22A5, H22A6, H22A8, H22Z1		EPBMP3-R012Z	96590	10	170

S2000 (AP)

2.0	1.997	177	4	06.1999-	F20C VTEC		EPBMP3-R012Z	96590	10	170
-----	-------	-----	---	----------	-----------	--	--------------	-------	----	-----

SHUTTLE (RA)

2.2 16V	2.156	110	4	10.1994-02.1998	F22B8		EPBMP3-R012Z	96590	10	170
2.3 16V	2.254	110	4	10.1997-06.2004	F23A7		EPBMP3-R012Z	96590	10	170

STREAM (RN)

1.7 16V	1.668	92	4	05.2001-09.2006	D17A2		EPBMP3-A015Z	94611	10	165
2.0 16V	1.998	115	4	05.2001-09.2006	K20A1		EPBMP3-A015Z	94611	10	165

HYUNDAI

ACCENT I (X-3)

1.3	1.341	44	4	10.1994-01.2000	G4CH, G4EH		EPBMP3-A003Z	92477	15	102
1.3	1.341	55	4	10.1994-01.2000	G4DH, G4EH		EPBMP3-A003Z	92477	15	102
1.3 i 12V	1.341	62	4	10.1994-01.2000	G4EH		EPBMP3-A003Z	92477	15	102
1.5 i 12V	1.495	65	4	10.1994-01.2000	G4EK		EPBMP3-A003Z	92477	15	102
1.5 i 16V	1.495	73	4	12.1995-01.2000	G4FK		EPBMP4-V043Z	97765	20	115

ACCENT II (LC)

1.3	1.341	55	4	01.2000-11.2005	G4EA		EPBMP4-V039Z	96769	10	115
1.3	1.341	61	4	01.2000-11.2005	G4EA		EPBMP4-V039Z	96769	10	115



MAP

 kW
C
Y
I

Type-N°

Stock-N°

 kPa from
kPa to

HYUNDAI
ACCENT II (LC)

1.3	1.341	62	4	08.2002-11.2005	G4EH		EPBMPT4-V039Z	96769	10	115
1.3	1.341	63	4	01.2000-11.2005	G4EA		EPBMPT4-V039Z	96769	10	115
1.5	1.495	65	4	09.1999-10.2002	G4EK		EPBMPT4-V039Z	96769	10	115
1.5	1.495	66	4	01.2000-11.2005	G4EB		EPBMPT4-V039Z	96769	10	115
1.5	1.495	68	4	01.2000-10.2002	G4EK		EPBMPT4-V039Z	96769	10	115
1.5	1.495	69	4	01.2000-12.2006	G4EK		EPBMPT4-V039Z	96769	10	115
1.5	1.495	73	4	09.1999-10.2002	G4FK		EPBMPT4-V039Z	96769	10	115
1.5	1.495	75	4	09.2000-11.2005	G4EC-G		EPBMPT4-V039Z	96769	10	115
1.5	1.495	75	4	09.1999-10.2002	G4FK		EPBMPT4-V039Z	96769	10	115
1.5	1.495	77	4	09.1999-10.2002	G4FK		EPBMPT4-V039Z	96769	10	115
1.6	1.599	77	4	12.2002-11.2005	G4ED-G		EPBMPT4-V039Z	96769	10	115

ACCENT III (MC)

1.4 GL	1.399	71	4	11.2005-11.2010	G4EE		EPBMPT4-V039Z	96769	10	115
1.5 CRDi GLS	1.493	81	4	11.2005-11.2010	D4FA		EPBMPT4-V014Z	97115	25	950
1.6 GLS	1.599	82	4	11.2005-11.2010	G4ED		EPBMPT4-V039Z	96769	10	115

ACCENT IV (RB)

1.4	1.368	74	4	11.2010-	G4LC		EPBMPT4-V018Z	95148	10	120
1.4	1.396	79	4	11.2010-	G4FA		EPBMPT4-V018Z	95148	10	120
1.4	1.396	80	4	11.2010-12.2017	G4FA		EPBMPT4-V018Z	95148	10	120
1.6	1.591	90	4	11.2010-	G4FC		EPBMPT4-V018Z	95148	10	120
1.6	1.591	91	4	11.2010-	G4FC	; Position: Intake Manifold	EPBMPT4-V018Z	95148	10	120
1.6 CRDi	1.582	100	4	04.2011-	D4FB		EPBMBN3-V006Z	94835	18,2	300,2

ACCENT SALOON (HC) | SOLARIS

1.4	1.368	74	4	07.2018-	G4LC		EPBMPT4-V018Z	95148	10	120
-----	-------	----	---	----------	------	--	---------------	-------	----	-----

ATOS (MX) | AMICA / ATOZ

1.0 i	999	40	4	02.1998-12.2000	G4HC		EPBMPT4-V039Z	96769	10	115
1.0 i	999	41	4	02.1998-03.2002	G4HC		EPBMPT4-V039Z	96769	10	115
1.0 i	999	43	4	03.2001-07.2003	G4HC-E		EPBMPT4-V039Z	96769	10	115
1.1	1.086	43	4	08.2003-12.2008	G4HD		EPBMPT4-V039Z	96769	10	115
1.1	1.086	45	4	06.2003-12.2010	G4HG		EPBMPT4-V039Z	96769	10	115
1.1	1.086	46	4	08.2003-12.2008	G4HG		EPBMPT4-V039Z	96769	10	115

COUPE (GK) | TUSCANI

1.6 16V	1.599	77	4	03.2002-08.2009	G4ED-G		EPBMPT4-V039Z	96769	10	115
1.6 16V	1.599	79	4	03.2002-08.2009	G4ED-G		EPBMPT4-V039Z	96769	10	115
2.0	1.975	100	4	08.2001-08.2009	G4GC-G		EPBMPT4-V039Z	96769	10	115
2.0	1.975	102	4	03.2002-08.2009	G4GC-G		EPBMPT4-V039Z	96769	10	115
2.0	1.975	102	4	03.2002-08.2009	G4GC-G		EPBMPN3-A003Z	92477	15	102
2.0 GLS	1.975	105	4	02.2003-08.2009	G4GC-G		EPBMPT4-V039Z	96769	10	115



HYUNDAI





COUPE (RD) | TIBURON

1.6 i 16V	1.599	84	4	12.1996-04.2002	G4GR		EPBMPN3-A003Z	92477	15	102
1.6 i 16V	1.599	84	4	07.2000-	G4GR		EPBMPT4-V039Z	96769	10	115
1.6 16V	1.599	85	4	07.2000-	G4GR		EPBMPT4-V039Z	96769	10	115
2.0 16V	1.975	99	4	03.2001-04.2002	G4DF		EPBMPN3-A003Z	92477	15	102
2.0	1.975	101	4	08.1999-01.2002	G4DF		EPBMPN3-A003Z	92477	15	102
2.0 16V	1.975	102	4	08.1996-04.2002	G4DF, G4GF		EPBMPN3-A003Z	92477	15	102

CRETA

1.6	1.591	90	4	01.2016-	G4FG		EPBMPT4-V018Z	95148	10	120
1.6 4WD	1.591	90	4	08.2016-	G4FG		EPBMPT4-V018Z	95148	10	120



ELANTRA (XD) | AVANTE

1.6	1.599	66	4	06.2000-07.2006	G4GR		EPBMPT4-V039Z	96769	10	115
1.6	1.599	77	4	05.2003-07.2006	G4ED-G		EPBMPT4-V039Z	96769	10	115
1.6	1.599	79	4	06.2000-07.2006	G4ED-G		EPBMPT4-V039Z	96769	10	115
1.6	1.599	82	4	09.2003-07.2006	G4GA		EPBMPT4-V039Z	96769	10	115
1.8	1.795	79	4	06.2000-07.2003	G4BB		EPBMPT4-V039Z	96769	10	115
1.8	1.795	97	4	06.2000-07.2006	G4BB, G4GB		EPBMPT4-V039Z	96769	10	115
2.0	1.975	102	4	06.2000-07.2006	G4GC-G		EPBMPT4-V039Z	96769	10	115
2.0	1.975	104	4	06.2000-07.2006	G4GC		EPBMPT4-V039Z	96769	10	115
2.0	1.975	105	4	10.2003-07.2006	G4GC		EPBMPT4-V039Z	96769	10	115

ELANTRA SALOON (AD, ADA)

2.0	1.999	110	4	02.2016-	G4NH		EPBMPT4-V018Z	95148	10	120
2.0	1.999	112	4	10.2015-	G4NA	 ;  6-Speed	EPBMPT4-V018Z	95148	10	120

ELANTRA SALOON (HD)

1.6 CVT	1.591	90	4	06.2006-06.2011	G4FC		EPBMPT4-V018Z	95148	10	120
2.0 CVT	1.975	103	4	06.2006-05.2010	G4GC		EPBMPT4-V039Z	96769	10	115
2.0 CVT	1.975	105	4	06.2006-06.2011	G4GC		EPBMPT4-V039Z	96769	10	115

ELANTRA SALOON (MD, UD) | I35 | AVANTE

1.6	1.591	94	4	04.2011-04.2016	G4FG	 ; Position: Intake Manifold	EPBMPT4-V018Z	95148	10	120
1.6	1.591	96	4	06.2011-12.2015	G4FG		EPBMPT4-V018Z	95148	10	120
1.6	1.591	97	4	06.2011-12.2015	G4FG		EPBMPT4-V018Z	95148	10	120
1.6 CRDi	1.582	100	4	10.2015-	D4FB	 ; Euro 5	EPBMBN3-V006Z	94835	18,2	300,2
1.8	1.797	110	4	09.2010-	G4NB		EPBMPT4-V018Z	95148	10	120

EQUUS / CENTENNIAL

3.8	3.778	213	6	03.2009-	G6DA		EPBMPN3-V030Z	92953	10	115
5.0 GDi	5.038	316	8	03.2009-	G8BE		EPBMPT4-V018Z	95148	10	120

EQUUS / CENTENNIAL (JS)

3.5	3.497	155	6	10.1999-03.2009	G6CU		EPBMPN3-V030Z	92953	10	115
-----	-------	-----	---	-----------------	------	---	---------------	-------	----	-----

GENESIS (BH)

3.8 V6	3.778	213	6	01.2008-12.2014	G6DA	 ; Multi Point Injection (MPI)	EPBMPN3-V030Z	92953	10	115
--------	-------	-----	---	-----------------	------	---	---------------	-------	----	-----

MAP



l kW
C
Y
I



Type-N°

Stock-N°

kPa from

kPa to

HYUNDAI

GENESIS COUPE

2.0 CVT	1.998	154	4	06.2008-02.2014	G4KF		EPBBPT4-V007Z	94941	20	250
2.0 T	1.998	157	4	01.2008-12.2012	G4KF		EPBBPT4-V007Z	94941	20	250
2.0 CVT	1.998	184	4	02.2013-02.2014	G4KF		EPBMPT4-V014Z	97115	25	950
2.0 T	1.998	202	4	11.2011-12.2014	G4KF		EPBMPT4-V014Z	97115	25	950

GETZ (TB)

1.1	1.086	46	4	09.2002-09.2005	G4HD		EPBMPT4-V039Z	96769	10	115
1.1	1.086	49	4	09.2005-06.2009	G4HD		EPBMPT4-V039Z	96769	10	115
1.3 i	1.341	60	4	09.2002-03.2004	G4EA		EPBMPT4-V039Z	96769	10	115
1.3	1.341	61	4	09.2004-06.2009	G4EA		EPBMPT4-V039Z	96769	10	115
1.3	1.341	63	4	09.2003-09.2005	G4EA		EPBMPT4-V039Z	96769	10	115
1.4 i	1.399	71	4	08.2005-12.2010	G4EE		EPBMPT4-V039Z	96769	10	115
1.5 CRDi	1.493	65	4	08.2005-06.2009	D4FA		EPBMPT4-V014Z	97115	25	950
1.5 CRDi GLS	1.493	81	4	08.2005-06.2009	D4FA		EPBMPT4-V014Z	97115	25	950
1.6	1.599	77	4	09.2002-09.2005	G4ED-G		EPBMPT4-V039Z	96769	10	115
1.6	1.599	78	4	06.2005-12.2006	G4ED-G		EPBMPT4-V039Z	96769	10	115

GRAND SANTA FÉ

3.3	3.342	183	6	01.2014-	G6DF		EPBMPT4-V018Z	95148	10	120
-----	-------	-----	---	----------	------	--	---------------	-------	----	-----

GRANDEUR (HG) | AZERA

2.4	2.359	132	4	07.2011-	G4KE		EPBMPT4-V018Z	95148	10	120
3.0 MPI	2.999	184	6	07.2011-	G6DG		EPBMPT4-V018Z	95148	10	120

GRANDEUR (IG) | AZERA

3.0 GDI	2.999	192	6	11.2016-	G6DL		EPBMPT4-V018Z	95148	10	120
---------	-------	-----	---	----------	------	--	---------------	-------	----	-----

GRANDEUR (TG) | AZERA

2.2 CRDi	2.188	110	4	06.2006-12.2011	D4EB	; With Charger Intercooler	EPBMPT4-V014Z	97115	25	950
2.2 CRDi	2.188	114	4	06.2006-10.2010	D4EB	; With Charger Intercooler	EPBMPT4-V014Z	97115	25	950
2.7	2.656	141	6	-02.2008	G6BA		EPBMPN3-V030Z	92953	10	115
3.3	3.342	173	6	04.2005-12.2010	G6DB		EPBMPN3-V030Z	92953	10	115
3.3	3.342	191	6	11.2010-12.2011	G6DB		EPBMPN3-V030Z	92953	10	115
3.3	3.342	198	6	02.2007-12.2011	G6DB		EPBMPN3-V030Z	92953	10	115

H-1 (A1)

2.4 4WD	2.351	82	4	02.1998-04.2004	G4CS		EPBMPN3-V030Z	92953	10	115
2.4	2.351	82	4	06.1997-04.2004	G4CS		EPBMPN3-V030Z	92953	10	115
2.4 4WD	2.351	99	4	06.2001-04.2004	G4JS		EPBMPN3-V030Z	92953	10	115
2.4	2.351	101	4	02.2003-04.2004	G4JS		EPBMPN3-V030Z	92953	10	115
2.4	2.351	107	4	11.2001-04.2004	G4JS		EPBMPN3-V030Z	92953	10	115
2.5 D	2.476	57	4	10.1997-04.2004	D4BF		EPBBPT4-V007Z	94941	20	250
2.5 TD 4WD	2.476	59	4	02.1998-04.2004	D4BF		EPBBPT4-V007Z	94941	20	250
2.5 TD	2.476	59	4	06.1997-04.2004	D4BF		EPBBPT4-V007Z	94941	20	250



MAP



ℓ kW C
Y I



Type-N°

Stock-N°

kPa from

kPa to

HYUNDAI

H-1 (A1)

2.5 TD	2.476	59	4	03.2000-09.2000	D4BF		EPBBPT4-V007Z	94941	20	250
2.5 TD 4WD	2.476	73	4	03.2001-04.2004	D4BH		EPBBPT4-V007Z	94941	20	250
2.5 TCi	2.476	73	4	10.1997-12.2007	D4BH		EPBBPT4-V007Z	94941	20	250
2.5 TD	2.476	73	4	03.2000-10.2006	D4BH		EPBBPT4-V007Z	94941	20	250
2.5 D	2.476	73	4	06.2000-10.2006	D4BH		EPBBPT4-V007Z	94941	20	250
2.5 TCi	2.476	74	4	05.2004-12.2007	D4BH		EPBBPT4-V007Z	94941	20	250
2.5 TD 4WD	2.476	74	4	11.2001-04.2004	D4BH		EPBBPT4-V007Z	94941	20	250
2.5 TD	2.476	74	4	10.2001-08.2007	D4BH		EPBBPT4-V007Z	94941	20	250
2.5 CRDi	2.497	81	4	07.2001-04.2004	D4CB	; Euro 4 (D4); Engine Model: VGT	EPBMPT4-V014Z	97115	25	950
2.5 CRDi	2.497	103	4	12.2002-	D4CB	; Euro 4 (D4); Engine Model: VGT	EPBMPT4-V014Z	97115	25	950
2.5 CRDi 4WD	2.497	103	4	12.2002-04.2004	D4CB	; Euro 4 (D4); Engine Model: VGT	EPBMPT4-V014Z	97115	25	950
2.5 CRDi	2.497	103	4	12.2002-12.2007	D4CB	; Euro 4 (D4); Engine Model: VGT	EPBMPT4-V014Z	97115	25	950
2.5 CRDi	2.497	120	4	12.2002-04.2004	D4CB	; Engine Model: VGT; Euro 4 (D4)	EPBMPT4-V014Z	97115	25	950

H-1 (TQ)

2.4 i	2.359	129	4	02.2008-	G4KC		EPBMPT4-V018Z	95148	10	120
-------	-------	-----	---	----------	------	--	---------------	-------	----	-----

H100 (P) | H 150 | H100 / GRACE | BAKKIE

2.5 TD	2.476	59	4	07.1993-03.2000	D4BF	; Euro 2	EPBBPT4-V007Z	94941	20	250
--------	-------	----	---	-----------------	------	----------	---------------	-------	----	-----

H100 | H 150 | GRACE | H100 / GRACE

2.5 TDiC	2.476	59	4	06.1998-10.2003	D4BF	; Euro 2	EPBBPT4-V007Z	94941	20	250
----------	-------	----	---	-----------------	------	----------	---------------	-------	----	-----

H100 PLATFORM (HR) | BAKKI

2.5 TD	2.477	74	4	11.2006-	4D56T		EPBBPT4-V007Z	94941	20	250
--------	-------	----	---	----------	-------	--	---------------	-------	----	-----

H100 PLATFORM | BAKKIE

2.5 D	2.476	59	4	05.1996-12.1997	D4BF		EPBBPT4-V007Z	94941	20	250
-------	-------	----	---	-----------------	------	--	---------------	-------	----	-----

HIGHWAY VAN

2.0 CVVT	1.975	104	4	11.2003-03.2004	G4GC		EPBMPT4-V039Z	96769	10	115
----------	-------	-----	---	-----------------	------	--	---------------	-------	----	-----

I10 (BA, IA) | GRAND I10

1.0 LPG	998	49	3	02.2014-	B3LA		EPBMPT4-V018Z	95148	10	120
1.0 LPG	998	51	3	07.2014-08.2016	B3LA		EPBMPT4-V018Z	95148	10	120
1.2	1.248	64	4	12.2013-	G4LA		EPBMPT4-V018Z	95148	10	120

I10 (PA)

1.0	998	51	3	01.2011-12.2017	G3LA		EPBMPT4-V018Z	95148	10	120
1.1	1.086	48	4	12.2007-12.2013	G4HG		EPBMPT4-V039Z	96769	10	115
1.1	1.086	49	4	01.2008-12.2013	G4HG		EPBMPT4-V039Z	96769	10	115
1.1	1.086	50	4	-08.2010	G4HG		EPBMPT4-V039Z	96769	10	115
1.1	1.086	50	4	09.2010-	G4HG		EPBMPT4-V018Z	95148	10	120
1.1	1.086	51	4	04.2011-12.2013	G4HG		EPBMPT4-V018Z	95148	10	120
1.1 LPG	1.086	51	4	04.2011-12.2013	G4HG		EPBMPT4-V018Z	95148	10	120
1.1 CRDi	1.120	55	3	01.2008-12.2011	D3FA	; With Charger Intercooler	EPBMPT4-V014Z	97115	25	950
1.2	1.248	57	4	11.2008-12.2011	G4LA		EPBMPT4-V018Z	95148	10	120



MAP



l kW
C
Y
I



Type-N°

Stock-N°

kPa from
kPa to

HYUNDAI

I10 (PA)

1.2	1.248	63	4	04.2011-12.2013	G4LA		EPBMPT4-V018Z	95148	10	120
-----	-------	----	---	-----------------	------	--	---------------	-------	----	-----

I10 SALOON

1.2	1.248	64	4	08.2015-	G4LA		EPBMPT4-V018Z	95148	10	120
-----	-------	----	---	----------	------	--	---------------	-------	----	-----

I20 (GB, IB)

1.0 T-GDI	998	74	3	09.2015-	G3LC		EPBMPT4-V014Z	97115	25	950
1.0 T-GDI	998	88	3	09.2015-	G3LC		EPBMPT4-V014Z	97115	25	950
1.1 CRDi	1.120	55	3	11.2014-	D3FA		EPBMPT4-V031Z	94763	18,2	300,2
1.2	1.248	55	4	11.2014-	G4LA		EPBMPT4-V018Z	95148	10	120
1.2 LPG	1.248	55	4	01.2019-	G4LA		EPBMPT4-V018Z	95148	10	120
1.2 LPGI	1.248	61	4	11.2014-	G4LA		EPBMPT4-V018Z	95148	10	120
1.2	1.248	62	4	11.2014-	G4LA		EPBMPT4-V018Z	95148	10	120
1.4 CRDi	1.396	66	4	11.2014-	D4FC		EPBMBN3-V006Z	94835	18,2	300,2
1.4	1.368	74	4	09.2015-	G4LC		EPBMPT4-V018Z	95148	10	120

I20 (PB, PBT)

1.2	1.248	57	4	09.2008-12.2012	G4LA		EPBMPT4-V018Z	95148	10	120
1.2	1.248	63	4	03.2012-12.2015	G4LA		EPBMPT4-V018Z	95148	10	120
1.4	1.396	74	4	09.2008-12.2015	G4FA		EPBMPT4-V018Z	95148	10	120
1.6	1.591	93	4	09.2008-12.2012	G4FC		EPBMPT4-V018Z	95148	10	120

I30 (FD)

1.4	1.396	77	4	10.2007-06.2012	G4FA		EPBMPT4-V018Z	95148	10	120
1.4	1.396	80	4	10.2007-06.2012	G4FA		EPBMPT4-V018Z	95148	10	120
1.6	1.591	85	4	10.2007-06.2012	G4FC		EPBMPT4-V018Z	95148	10	120
1.6	1.591	90	4	10.2007-06.2012	G4FC		EPBMPT4-V018Z	95148	10	120
1.6	1.591	93	4	02.2008-06.2012	G4FC		EPBMPT4-V018Z	95148	10	120
2.0	1.975	105	4	10.2007-06.2012	G4GC-G	; Position: Suction Pipe	EPBMPT4-V039Z	96769	10	115
2.0	1.975	105	4	10.2007-06.2012	G4GC		EPBMPT4-V039Z	96769	10	115

I30 (GD)

1.4	1.368	74	4	12.2014-12.2016	G4LC		EPBMPT4-V018Z	95148	10	120
1.4 CRDi	1.396	66	4	12.2011-12.2016	D4FC	; Position: Intake Manifold	EPBMBN3-V006Z	94835	18,2	300,2
1.4	1.396	73	4	12.2011-12.2015	G4FA		EPBMPT4-V018Z	95148	10	120
1.6 CRDi	1.582	81	4	12.2011-12.2016	D4FB	; Position: Intake Manifold	EPBMBN3-V006Z	94835	18,2	300,2
1.6	1.591	88	4	01.2012-12.2016	G4FC		EPBMPT4-V018Z	95148	10	120
1.6 CRDi	1.582	94	4	12.2011-12.2015	D4FB	; Position: Intake Manifold	EPBMBN3-V006Z	94835	18,2	300,2
1.6	1.591	95	4	12.2011-12.2015	G4FG	; Position: Intake Manifold	EPBMPT4-V014Z	97115	25	950
1.6	1.591	95	4	12.2011-12.2015	G4FG	; Position: Intake Manifold	EPBMPT4-V018Z	95148	10	120
1.6	1.591	96	4	06.2014-	G4FC		EPBMPT4-V018Z	95148	10	120
1.6 GDI	1.591	99	4	12.2011-12.2016	G4FD		EPBMPT4-V018Z	95148	10	120
1.6 CRDi	1.582	100	4	11.2011-12.2016	D4FB		EPBMBN3-V006Z	94835	18,2	300,2



HYUNDAI

I30 (GD)

1.6 T-GDI	1.591	137	4	01.2015-	G4FJ		EPBMPT4-V014Z	97115	25	950
-----------	-------	-----	---	----------	------	---	---------------	-------	----	-----

I30 (PDE, PD, PDEN)

1.0 T-GDI	998	88	3	11.2016-	G3LC		EPBMPT4-V014Z	97115	25	950
1.4 MPI	1.368	73	4	05.2017-	G4LC		EPBMPT4-V018Z	95148	10	120
1.4 MPI	1.368	74	4	11.2016-	G4LC		EPBMPT4-V018Z	95148	10	120
1.4 T-GDI	1.353	103	4	11.2016-	G4LD		EPBMPT4-V014Z	97115	25	950
1.6 CRDi	1.582	70	4	11.2016-	D4FB		EPBMBN3-V006Z	94835	18,2	300,2
1.6 CRDi	1.598	70	4	08.2018-	D4FE		EPBMBN3-V006Z	94835	18,2	300,2
1.6 CRDi	1.582	81	4	11.2016-	D4FB		EPBMBN3-V006Z	94835	18,2	300,2
1.6 CRDi	1.598	85	4	08.2018-	D4FE		EPBMBN3-V006Z	94835	18,2	300,2
1.6 CRDi	1.582	94	4	08.2018-	D4FB		EPBMBN3-V006Z	94835	18,2	300,2
1.6 CRDi	1.582	100	4	03.2017-	D4FB		EPBMBN3-V006Z	94835	18,2	300,2
1.6 CRDi	1.598	100	4	08.2018-	D4FE		EPBMBN3-V006Z	94835	18,2	300,2
2.0 N	1.998	184	4	07.2017-	G4KH		EPBMPT4-V014Z	97115	25	950
2.0 N	1.998	202	4	07.2017-	G4KH		EPBMPT4-V014Z	97115	25	950

I30 COUPE

1.4 CRDi	1.396	66	4	05.2013-	D4FC		EPBMBN3-V006Z	94835	18,2	300,2
1.4	1.396	73	4	05.2013-	G4FA	 ; Euro 3 (D3)	EPBMPT4-V018Z	95148	10	120
1.4	1.368	74	4	12.2014-	G4LC		EPBMPT4-V018Z	95148	10	120
1.6 CRDi	1.582	81	4	11.2015-	D4FB	 ; Euro 4 (D4); Euro 5; Euro 6	EPBMBN3-V006Z	94835	18,2	300,2
1.6 MPI	1.591	88	4	11.2016-	G4FC		EPBMPT4-V018Z	95148	10	120
1.6 CRDi	1.582	94	4	05.2013-	D4FB	 ; Euro 4 (D4); Euro 5; Euro 6	EPBMBN3-V006Z	94835	18,2	300,2
1.6 GDI	1.591	99	4	05.2013-	G4FD		EPBMPT4-V018Z	95148	10	120
1.6 CRDi	1.582	100	4	12.2014-	D4FB	 ; Euro 4 (D4); Euro 5; Euro 6	EPBMBN3-V006Z	94835	18,2	300,2
1.6 T-GDI	1.591	137	4	01.2015-	G4FJ		EPBMPT4-V014Z	97115	25	950

I40 (VF)

1.6 CRDi	1.598	85	4	07.2018-	D4FE		EPBMBN3-V006Z	94835	18,2	300,2
1.6 GDI	1.591	99	4	07.2011-	G4FD		EPBMPT4-V018Z	95148	10	120
1.6 CRDi	1.598	100	4	07.2018-	D4FE		EPBMBN3-V006Z	94835	18,2	300,2
1.7 CRDi	1.685	85	4	-01.2015	D4FD	 ; Position: Intake Manifold	EPBMPT4-V018Z	95148	10	120
1.7 CRDi	1.685	85	4	01.2015-	D4FD	 ; Position: Intake Manifold	EPBMBN3-V006Z	94835	18,2	300,2
1.7 CRDi	1.685	100	4	-01.2015	D4FD	 ; Position: Intake Manifold	EPBMPT4-V018Z	95148	10	120
1.7 CRDi	1.685	100	4	01.2015-	D4FD	 ; Position: Intake Manifold	EPBMBN3-V006Z	94835	18,2	300,2
1.7 CRDi	1.685	104	4	01.2015-	D4FD		EPBMBN3-V006Z	94835	18,2	300,2
2.0 CVVT	1.999	110	4	10.2012-	G4NA		EPBMPT4-V018Z	95148	10	120
2.0 GDi	1.999	121	4	12.2014-	G4NC		EPBMPT4-V018Z	95148	10	120
2.0 CVVT	1.999	121	4	10.2012-	G4NA		EPBMPT4-V018Z	95148	10	120
2.0 GDI	1.999	130	4	07.2011-	G4NC		EPBMPT4-V018Z	95148	10	120

MAP



l kW
C
Y
I



Type-N°

Stock-N°

kPa from
kPa to

HYUNDAI

I40 (VF)

2.0 GDI	1.999	131	4	03.2012-	G4NC		EPBMPT4-V018Z	95148	10	120
---------	-------	-----	---	----------	------	--	---------------	-------	----	-----

IONIQ (AE)

1.6 GDI Hybrid	1.580	77	4	03.2016-	G4LE	; Euro 5	EPBMPT4-V018Z	95148	10	120
1.6 GDI Hybrid	1.580	104	4	03.2016-	G4LE	; Euro 5	EPBMPT4-V018Z	95148	10	120

IX20 (JC)

1.4	1.396	66	4	11.2010-	G4FA		EPBMPT4-V018Z	95148	10	120
1.4 LPG	1.396	66	4	11.2010-	G4FA		EPBMPT4-V018Z	95148	10	120
1.4	1.396	74	4	11.2010-	G4FA		EPBMPT4-V018Z	95148	10	120
1.6	1.591	92	4	11.2010-	G4FC		EPBMPT4-V018Z	95148	10	120
1.6 LPG	1.591	92	4	11.2010-	G4FC		EPBMPT4-V018Z	95148	10	120

IX35 (LM, EL, ELH) | TUCSON

1.6	1.591	99	4	11.2010-	G4FD		EPBMPT4-V018Z	95148	10	120
2.0 CVVT, 2.0 CVVT 4WD	1.998	110	4	08.2009-	G4KD		EPBMPT4-V018Z	95148	10	120
2.0 CVVT, 2.0 CVVT 4WD	1.999	110	4	08.2013- 12.2015	G4NA		EPBMPT4-V018Z	95148	10	120
2.0	1.999	113	4	08.2013- 12.2015	G4NA		EPBMPT4-V018Z	95148	10	120
2.0 4WD	1.999	116	4	09.2014-	G4NA		EPBMPT4-V018Z	95148	10	120
2.0, 2.0 4WD	1.998	120	4	01.2010-	G4KD		EPBMPT4-V018Z	95148	10	120
2.0	1.998	122	4	01.2010-	G4KD		EPBMPT4-V018Z	95148	10	120
2.0 Gdi, 2.0 Gdi 4WD	1.999	122	4	08.2013-	G4NC		EPBMPT4-V018Z	95148	10	120
2.4 DCVVT-I 4WD	2.359	128	4	07.2010- 12.2013	G4KE	; Position: Intake Manifold	EPBMPT4-V018Z	95148	10	120
2.4 4WD	2.359	129	4	09.2012- 12.2013	G4KE		EPBMPT4-V018Z	95148	10	120

IX55

3.8 V6 4WD	3.778	191	6	01.2007-	G6DA		EPBMPN3-V030Z	92953	10	115
3.8 V6	3.778	194	6	01.2011-	G6DA	; Position: Intake Manifold	EPBMPN3-V030Z	92953	10	115
3.8 V6 4WD	3.778	194	6	01.2011-	G6DA		EPBMPN3-V030Z	92953	10	115

KONA (OS) | KAUAI

1.0 T-GDi	998	88	3	07.2017-	G3LC		EPBMPT4-V014Z	97115	25	950
1.6 GDi Hybrid	1.580	77	4	06.2019-	G4LE		EPBMPT4-V018Z	95148	10	120
1.6 CRDi	1.598	85	4	08.2018-	D4FE		EPBMBN3-V006Z	94835	18,2	300,2
1.6 CRDi e-VGT	1.598	100	4	08.2018-	D4FE		EPBMBN3-V006Z	94835	18,2	300,2
1.6 CRDi e-VGT AWD	1.598	100	4	08.2018-	D4FE		EPBMBN3-V006Z	94835	18,2	300,2
1.6 T-GDi	1.591	130	4	07.2017-	G4FJ		EPBMPT4-V014Z	97115	25	950
1.6 T-GDi 4WD	1.591	130	4	06.2017-	G4FJ		EPBMPT4-V014Z	97115	25	950

LANTRA I (J-1)

1.5 i.e.	1.468	63	4	10.1990- 11.1995	G4DJ		EPBMPN3-A003Z	92477	15	102
----------	-------	----	---	---------------------	------	--	---------------	-------	----	-----

LANTRA II (J-2)

1.5 12V	1.495	65	4	12.1996- 09.2000	G4EK		EPBMPN3-A003Z	92477	15	102
1.6 i	1.599	66	4	11.1995- 09.2000	G4GR		EPBMPN3-A003Z	92477	15	102
1.6 16V	1.599	84	4	11.1995- 09.2000	G4GR		EPBMPN3-A003Z	92477	15	102



HYUNDAI

LANTRA II (J-2)

1.8 16V	1.795	94	4	11.1995-09.2000	G4GM		EPBMPN3-A003Z	92477	15	102
2.0 16V	1.975	102	4	11.1995-10.2000	G4GF		EPBMPN3-A003Z	92477	15	102



MATRIX (FC) | LAVITA

1.5 CRDi	1.493	75	4	12.2004-08.2010	D4FA		EPBBPT4-V007Z	94941	20	250
1.5 CRDi	1.493	75	4	12.2004-08.2010	D4FA	 ; Euro 4 (D4)	EPBMPT4-V014Z	97115	25	950
1.5 CRDi VGT	1.493	81	4	08.2005-08.2010	D4FA	 ; Position: Suction Pipe	EPBBPT4-V007Z	94941	20	250
1.5 CRDi VGT	1.493	81	4	08.2005-08.2010	D4FA	 ; Euro 4 (D4); With Charger Intercooler	EPBMPT4-V014Z	97115	25	950
1.6	1.599	66	4	01.2002-12.2005	G4ED-L		EPBMPT4-V039Z	96769	10	115
1.6	1.599	76	4	06.2001-08.2010	G4ED-G		EPBMPT4-V039Z	96769	10	115
1.8	1.795	90	4	06.2001-08.2010	G4GB-G		EPBMPT4-V039Z	96769	10	115

PONY (X-1)

1.5	1.468	53	4	10.1985-09.1989	G4DJ		EPBMPN3-A003Z	92477	15	102
-----	-------	----	---	-----------------	------	---	---------------	-------	----	-----

PONY (X-2)

1.5	1.468	53	4	10.1989-01.1995	G15B, G4DJ		EPBMPN3-A003Z	92477	15	102
1.5 i	1.468	61	4	10.1989-01.1995	G15B, G4DJ		EPBMPN3-A003Z	92477	15	102
1.5 i	1.468	62	4	10.1989-01.1995	G15B, G4DJ		EPBMPN3-A003Z	92477	15	102







PORTER

2.5 TD	2.477	73	4	07.1994-04.2004	D4BH		EPBBPT4-V007Z	94941	20	250
--------	-------	----	---	-----------------	------	---	---------------	-------	----	-----









S COUPE (SLC)

1.5 i	1.468	62	4	02.1990-05.1996	G4DJ		EPBMPN3-A003Z	92477	15	102
1.5 i	1.495	65	4	04.1992-05.1996	G4EK		EPBMPN3-A003Z	92477	15	102

SANTA FÉ I (SM)

2.0 CRDi	1.991	83	4	08.2001-03.2006	D4EA		EPBBPN3-V023Z	90603	20	250
2.0 CRDi 4x4	1.991	83	4	04.2001-03.2006	D4EA		EPBBPN3-V023Z	90603	20	250
2.0	1.997	99	4	08.2001-03.2006	G4JP		EPBMPT4-V039Z	96769	10	115
2.4 16V	2.351	100	4	02.2001-03.2006	G4JS-G	 ; Position: Intake Manifold	EPBMPN3-V030Z	92953	10	115
2.4 16V 4x4	2.351	100	4	02.2001-03.2006	G4JS-G	 ; Position: Intake Manifold	EPBMPN3-V030Z	92953	10	115
2.4 16V	2.351	107	4	02.2001-03.2006	G4JS-G	 ; Position: Intake Manifold	EPBMPN3-V030Z	92953	10	115
2.4 16V 4x4	2.351	107	4	02.2001-03.2006	G4JS-G	 ; Position: Intake Manifold	EPBMPN3-V030Z	92953	10	115

SANTA FÉ II (CM)

2.0 CRDi	1.995	110	4	12.2010-12.2012	D4HA	 ; With Charger Intercooler	EPBMPT4-V014Z	97115	25	950
2.0 CRDi 4x4	1.995	110	4	12.2010-12.2012	D4HA	 ; With Charger Intercooler	EPBMPT4-V014Z	97115	25	950
2.2 CRDi	2.188	102	4	03.2006-12.2012	D4EB	 ; With Charger Intercooler	EPBMPT4-V014Z	97115	25	950
2.2 CRDi 4x4	2.188	102	4	03.2006-12.2012	D4EB	 ; With Charger Intercooler	EPBMPT4-V014Z	97115	25	950
2.2 CRDi GLS	2.188	110	4	03.2006-12.2009	D4EB	 ; With Charger Intercooler	EPBMPT4-V014Z	97115	25	950
2.2 CRDi GLS 4x4	2.188	110	4	03.2006-12.2009	D4EB	 ; With Charger Intercooler	EPBMPT4-V014Z	97115	25	950
2.2 CRDi	2.188	114	4	03.2006-12.2009	D4EB	 ; With Charger Intercooler	EPBMPT4-V014Z	97115	25	950
2.2 CRDi 4x4	2.188	114	4	03.2006-12.2009	D4EB	 ; With Charger Intercooler	EPBMPT4-V014Z	97115	25	950

MAP



l kW
C
Y
I



Type-Nº

Stock-Nº

kPa from
kPa to

HYUNDAI

SANTA FÉ II (CM)

2.4	2.359	128	4	11.2010-12.2012	G4KE		EPBMPT4-V018Z	95148	10	120
2.4 4x4	2.359	128	4	07.2010-12.2012	G4KE		EPBMPT4-V018Z	95148	10	120
2.7	2.656	125	6	03.2006-12.2012	G6BA		EPBMPN3-V030Z	92953	10	115
2.7 4x4	2.656	125	6	03.2006-12.2012	G6BA		EPBMPN3-V030Z	92953	10	115
2.7 V6 GLS	2.656	139	6	03.2006-12.2009	G6EA		EPBMPN3-V030Z	92953	10	115
2.7 V6 GLS 4x4	2.656	139	6	03.2006-12.2009	G6EA		EPBMPN3-V030Z	92953	10	115
2.7 4x4	2.656	147	6	01.2007-12.2012	G6BA		EPBMPN3-V030Z	92953	10	115

SANTA FÉ III (DM, DMA)

2.4 CCVT AWD	2.359	129	4	09.2012-	G4KE		EPBMPT4-V018Z	95148	10	120
2.4 GDI	2.359	138	4	05.2015-	G4KJ		EPBMPT4-V018Z	95148	10	120
2.4 GDI 4WD	2.359	138	4	05.2015-	G4KJ		EPBMPT4-V018Z	95148	10	120
2.4	2.359	141	4	09.2012-12.2015	G4KJ		EPBMPT4-V018Z	95148	10	120
2.4 4WD	2.359	141	4	09.2012-	G4KJ		EPBMPT4-V018Z	95148	10	120

SANTA FÉ IV (TM, TMA)

2.4 AWD	2.359	127	4	07.2018-	G4KE		EPBMPT4-V018Z	95148	10	120
2.4 GDI AWD	2.359	136	4	07.2018-	G4KJ		EPBMPT4-V018Z	95148	10	120
2.4 GDI AWD	2.359	138	4	07.2018-	G4KJ		EPBMPT4-V018Z	95148	10	120

SOLARIS (HCR) | ACCENT

1.4	1.368	74	4	01.2017-	G4LC		EPBMPT4-V018Z	95148	10	120
1.6	1.591	90	4	01.2017-	G4FG		EPBMPT4-V018Z	95148	10	120

SONATA IV (EF) | SONICA

2.0 16V	1.997	96	4	10.2001-11.2004	G4JP-EG		EPBMPT4-V039Z	96769	10	115
2.0 16V	1.997	100	4	06.1998-10.2001	G4JP-G		EPBMPT4-V039Z	96769	10	115
2.4 16V	2.351	105	4	03.1998-10.2001	G4BS		EPBMPN3-V030Z	92953	10	115

SONATA V (NF) | SONICA

2.0 VVTi GLS	1.998	106	4	05.2005-12.2010	G4KA		EPBMPT4-V018Z	95148	10	120
2.0 GLSi	1.998	119	4	07.2008-12.2010	G4KD		EPBMPT4-V018Z	95148	10	120
2.0 VVTi GLS	1.998	121	4	01.2008-12.2010	G4KD		EPBMPT4-V018Z	95148	10	120
2.4	2.359	128	4	06.2008-12.2010	G4KE		EPBMPT4-V018Z	95148	10	120
3.3	3.342	171	6	01.2005-12.2010	G6DB		EPBMPN3-V030Z	92953	10	115
3.3	3.342	173	6	06.2005-12.2010	G6DB		EPBMPN3-V030Z	92953	10	115
3.3	3.342	184	6	01.2008-12.2010	G6DB		EPBMPN3-V030Z	92953	10	115
3.3	3.342	186	6	09.2007-12.2008	G6DB		EPBMPN3-V030Z	92953	10	115

SONATA VI (YF)

2.0	1.998	110	4	01.2009-06.2014	G4KD		EPBMPT4-V018Z	95148	10	120
2.0 i	1.998	120	4	09.2012-06.2014	G4KD		EPBMPT4-V018Z	95148	10	120
2.0 i	1.998	121	4	01.2011-06.2014	G4KD	: Position: Intake Manifold	EPBMPT4-V018Z	95148	10	120
2.0	1.999	115	4	09.2010-12.2015	G4NA	: Position: Intake Manifold	EPBMPT4-V018Z	95148	10	120



MAP



l kW
C
Y
I



Type-N°

Stock-N°

kPa from

kPa to

HYUNDAI

SONATA VI (YF)

2.4	2.359	128	4	01.2009-11.2010	G4KC		EPBMPT4-V018Z	95148	10	120
2.4	2.359	130	4	01.2010-12.2015	G4KC		EPBMPT4-V018Z	95148	10	120

SONATA VII (LF)

2.0 CVT	1.999	110	4	11.2018-	G4NA		EPBMPT4-V018Z	95148	10	120
2.4	2.359	138	4	09.2014-	G4KJ		EPBMPT4-V018Z	95148	10	120

TERRACAN (HP)

2.5 TD	2.476	74	4	12.2001-12.2006	D4BH		EPBBPT4-V007Z	94941	20	250
3.5 i V6 4WD	3.497	143	6	12.2001-12.2006	G6CU		EPBMPN3-V030Z	92953	10	115
3.5 i V6 4WD	3.497	147	6	12.2001-12.2006	G6CU		EPBMPN3-V030Z	92953	10	115

TIBURON

2.0 CVT	1.975	105	4	10.2006-12.2008	G4GC		EPBMPT4-V039Z	96769	10	115
---------	-------	-----	---	-----------------	------	--	---------------	-------	----	-----

TRAJET (FO)

2.0 CRDi	1.991	83	4	04.2001-07.2008	D4EA		EPBBPN3-V023Z	90603	20	250
2.0	1.997	100	4	-02.2004	G4JP-G		EPBMPT4-V039Z	96769	10	115
2.0	1.975	104	4	11.2003-07.2008	G4GC		EPBMPT4-V039Z	96769	10	115

TUCSON (JM)

2.0 CRDi	1.991	83	4	08.2004-03.2010	D4EA	; Engine Model: VGT; Euro 4 (D4)	EPBMPT4-V014Z	97115	25	950
2.0 CRDi All-wheel Drive	1.991	83	4	08.2004-03.2010	D4EA	; Engine Model: VGT; Euro 4 (D4)	EPBMPT4-V014Z	97115	25	950
2.0 CRDi All-wheel Drive	1.991	103	4	01.2006-03.2010	D4EA-F	; Engine Model: VGT; Euro 4 (D4)	EPBMPT4-V014Z	97115	25	950
2.0	1.975	104	4	08.2004-	G4GC		EPBMPT4-V039Z	96769	10	115
2.0 All-wheel Drive	1.975	104	4	08.2004-03.2010	G4GC		EPBMPT4-V039Z	96769	10	115
2.0	1.975	105	4	01.2007-01.2012	G4GC		EPBMPT4-V039Z	96769	10	115
2.0 All-wheel Drive	1.975	105	4	07.2005-11.2010	G4GC		EPBMPT4-V039Z	96769	10	115

TUCSON (TL, TLE)

1.6 CRDi	1.598	85	4	08.2018-	D4FE		EPBMBN3-V006Z	94835	18,2	300,2
1.6 CRDi All-wheel Drive	1.598	85	4	08.2018-	D4FE		EPBMBN3-V006Z	94835	18,2	300,2
1.6 CRDi hybrid 48V	1.598	85	4	03.2019-	D4FE		EPBMBN3-V006Z	94835	18,2	300,2
1.6 GDi	1.591	97	4	06.2015-	G4FD		EPBMPT4-V018Z	95148	10	120
1.6 CRDi hybrid 48V	1.598	100	4	03.2019-	D4FE		EPBMBN3-V006Z	94835	18,2	300,2
1.6 CRDi hybrid 48V All-wheel Drive	1.598	100	4	03.2019-	D4FE		EPBMBN3-V006Z	94835	18,2	300,2
1.6 CRDi	1.598	100	4	08.2018-	D4FE		EPBMBN3-V006Z	94835	18,2	300,2
1.6 CRDi All-wheel Drive	1.598	100	4	08.2018-	D4FE		EPBMBN3-V006Z	94835	18,2	300,2
1.6 T-GDi	1.591	130	4	06.2015-	G4FJ		EPBMPT4-V014Z	97115	25	950
1.6 T-GDi All-wheel Drive	1.591	130	4	06.2015-	G4FJ		EPBMPT4-V014Z	97115	25	950
1.7 CRDi	1.685	85	4	06.2015-	D4FD		EPBMBN3-V006Z	94835	18,2	300,2
1.7 CRDi	1.685	104	4	06.2015-	D4FD	; Euro 5	EPBMBN3-V006Z	94835	18,2	300,2
2.0 CVT	1.999	110	4	06.2015-	G4NA	; Euro 3 (D3)	EPBMPT4-V018Z	95148	10	120
2.0	1.999	114	4	06.2015-	G4NA	; Euro 3 (D3)	EPBMPT4-V018Z	95148	10	120



MAP



l kW
C
Y
I



Type-N°

Stock-N°

kPa from

kPa to

HYUNDAI

TUCSON (TL, TLE)

2.4 GDI All-wheel Drive	2.359	135	4	07.2019-	G4KJ		EPBMPT4-V018Z	95148	10	120
-------------------------	-------	-----	---	----------	------	--	---------------	-------	----	-----

VELOSTER (FS)

1.6 GDI	1.591	103	4	03.2011-12.2017	G4FD		EPBMPT4-V018Z	95148	10	120
---------	-------	-----	---	-----------------	------	--	---------------	-------	----	-----

1.6 T-GDI	1.591	137	4	10.2012-12.2017	G4FJ		EPBMPT4-V014Z	97115	25	950
-----------	-------	-----	---	-----------------	------	--	---------------	-------	----	-----

XG (XG)

30	2.972	138	6	12.1998-12.2005	G6CT-G		EPBMPN3-V030Z	92953	10	115
----	-------	-----	---	-----------------	--------	--	---------------	-------	----	-----

3.0	2.972	153	6	10.2001-05.2005	G6CT		EPBMPN3-V030Z	92953	10	115
-----	-------	-----	---	-----------------	------	--	---------------	-------	----	-----

350	3.497	145	6	10.2002-12.2005	G6CU		EPBMPN3-V030Z	92953	10	115
-----	-------	-----	---	-----------------	------	--	---------------	-------	----	-----

XG SALOON

300	2.972	143	6	09.2000-12.2001	G6CT		EPBMPN3-V030Z	92953	10	115
-----	-------	-----	---	-----------------	------	--	---------------	-------	----	-----

INFINITI

EX

37	3.696	235	6	09.2010-	VQ37VHR		EPBMPN3-A050Z	96018		
----	-------	-----	---	----------	---------	--	---------------	-------	--	--

37	3.696	235	6	09.2010-	VQ37VHR	; Position: Brake Booster	EPBMPN3-A049Z	93927		
----	-------	-----	---	----------	---------	---------------------------	---------------	-------	--	--

FX

37 AWD	3.696	235	6	10.2008-	VQ37VHR		EPBMPN3-A050Z	96018		
--------	-------	-----	---	----------	---------	--	---------------	-------	--	--

37 AWD	3.696	235	6	10.2008-	VQ37VHR	; Position: Brake Booster	EPBMPN3-A049Z	93927		
--------	-------	-----	---	----------	---------	---------------------------	---------------	-------	--	--

G CONVERTIBLE

37	3.696	235	6	09.2010-	VQ37VHR		EPBMPN3-A049Z	93927		
----	-------	-----	---	----------	---------	--	---------------	-------	--	--

G COUPE

37	3.694	243	6	09.2007-	VQ37VHR		EPBMPN3-A049Z	93927		
----	-------	-----	---	----------	---------	--	---------------	-------	--	--

37	3.696	235	6	09.2010-	VQ37VHR		EPBMPN3-A049Z	93927		
----	-------	-----	---	----------	---------	--	---------------	-------	--	--

G SALOON

37	3.694	243	6	10.2008-	VQ37VHR		EPBMPN3-A049Z	93927		
----	-------	-----	---	----------	---------	--	---------------	-------	--	--

37 X	3.696	235	6	10.2008-	VQ37VHR		EPBMPN3-A049Z	93927		
------	-------	-----	---	----------	---------	--	---------------	-------	--	--

37	3.696	235	6	10.2008-	VQ37VHR		EPBMPN3-A049Z	93927		
----	-------	-----	---	----------	---------	--	---------------	-------	--	--

M (Y51)

37	3.696	235	6	03.2010-	VQ37VHR		EPBMPN3-A049Z	93927		
----	-------	-----	---	----------	---------	--	---------------	-------	--	--

M37

3.7	3.696	246	6	01.2011-	VQ37VHR		EPBMPN3-A049Z	93927		
-----	-------	-----	---	----------	---------	--	---------------	-------	--	--

3.7 AWD	3.696	246	6	01.2011-	VQ37VHR		EPBMPN3-A049Z	93927		
---------	-------	-----	---	----------	---------	--	---------------	-------	--	--

Q70 (Y51)

3.7	3.696	235	6	03.2013-	VQ37VHR		EPBMPN3-A049Z	93927		
-----	-------	-----	---	----------	---------	--	---------------	-------	--	--

QX50 I

37 AWD	3.696	235	6	08.2013-	VQ37VHR		EPBMPN3-A049Z	93927		
--------	-------	-----	---	----------	---------	--	---------------	-------	--	--

QX56

56 AWD	5.552	298	8	03.2010-	VK56VD		EPBMPN3-A050Z	96018		
--------	-------	-----	---	----------	--------	--	---------------	-------	--	--

ISUZU

TROOPER III

3.5 V6 24V	3.494	158	6	04.2000-08.2004	6VE1		EPBMPN3-V005Z	93871	20	100
------------	-------	-----	---	-----------------	------	--	---------------	-------	----	-----



MAP



l kW
C
Y
I



Type-Nº

Stock-Nº

kPa from

kPa to

ISUZU

TROOPER III

3.5 V6 24V AWD	3.494	158	6	04.2000-08.2004	6VE1		EPBMPN3-V005Z	93871	20	100
----------------	-------	-----	---	-----------------	------	--	---------------	-------	----	-----

IVECO

DAILY III

29L10V	2.287	70	4	09.2002-07.2007	F1AE0481A		EPBBPT4-V005Z	93700	20	250
35C10V, 35S10V	2.287	70	4	09.2002-07.2007	F1AE0481A		EPBBPT4-V005Z	93700	20	250
29L12V	2.287	85	4	09.2002-07.2007	F1AE0481B		EPBBPT4-V005Z	93700	20	250
35C12V, 35S12V	2.287	85	4	09.2002-07.2007	F1AE0481B		EPBBPT4-V005Z	93700	20	250
35C12, 35S12, 40C12	2.287	85	4	-03.2006	F1AE0481B		EPBBPT4-V005Z	93700	20	250
29L14	2.287	100	4	01.2005-04.2006	F1AE0481M		EPBBPT4-V005Z	93700	20	250
35C14, 35S14	2.287	100	4	01.2005-04.2006	F1AE0481M		EPBBPT4-V005Z	93700	20	250
35S9V, 35C9V	2.798	62	4	05.1999-07.2007	8140.63		EPBMPN3-A002Z	96249	15	100
29L9	2.798	66	4	-09.2002	8140.43R	; Engine No. <3487098	EPBBPT4-V012Z	96542	20	250
29L9	2.798	66	4	-09.2002	8140.43R	; Engine No. >3487099	EPBBPT4-V005Z	93700	20	250
35C9, 35S9	2.798	66	4	11.2001-04.2006	8140.43R	; Engine No. <3487098	EPBBPT4-V012Z	96542	20	250
35C9, 35S9	2.798	66	4	11.2001-04.2006	8140.43R	; Engine No. >3487099	EPBBPT4-V005Z	93700	20	250
29L11	2.798	78	4	05.1999-04.2006	8140.43B, 8140.43C		EPBBPT4-V012Z	96542	20	250
29L11	2.798	78	4	05.2001-03.2006	8140.43B		EPBBPT4-V005Z	93700	20	250
35S11V, 35C11V	2.798	78	4	05.1999-07.2007	8140.43B, 8140.43C		EPBBPT4-V012Z	96542	20	250
35S11V, 35C11V	2.798	78	4	05.2001-03.2006	8140.43B	; Engine No. >3487099	EPBBPT4-V005Z	93700	20	250
50C11	2.798	78	4	05.1999-07.2007	8140.43B, 8140.43C		EPBBPT4-V012Z	96542	20	250
50C11	2.798	78	4	05.2001-09.2004	8140.43B	; Engine No. >3487099	EPBBPT4-V005Z	93700	20	250
29L13	2.798	92	4	-03.2006	8140.43S	; Engine No. <3487098	EPBBPT4-V012Z	96542	20	250
29L13	2.798	92	4	-03.2006	8140.43S	; Engine No. >3487099	EPBBPT4-V005Z	93700	20	250
35S13V, 35C13V	2.798	92	4	-03.2006	8140.43S	; Engine No. <3487098	EPBBPT4-V012Z	96542	20	250
35S13V, 35C13V	2.798	92	4	-03.2006	8140.43S	; Engine No. >3487099	EPBBPT4-V005Z	93700	20	250
35S13, 40C13, 50C13	2.798	92	4	-03.2006	8140.43S		EPBBPT4-V005Z	93700	20	250
35S13, 40C13, 50C13	2.798	92	4	05.1999-05.2006	8140.43S		EPBBPT4-V012Z	96542	20	250
40C13	2.798	92	4	01.2001-09.2004	8140.43S	; Engine No. <3487098	EPBBPT4-V012Z	96542	20	250
40C13	2.798	92	4	01.2001-09.2004	8140.43S	; Engine No. >3487099	EPBBPT4-V005Z	93700	20	250
50C13	2.798	92	4	-09.2004	8140.43S	; Engine No. <3487098	EPBBPT4-V012Z	96542	20	250
50C13	2.798	92	4	-09.2004	8140.43S	; Engine No. >3487099	EPBBPT4-V005Z	93700	20	250
35C15	2.798	107	4	-03.2006	8140.43N	; Engine No. <3487098	EPBBPT4-V012Z	96542	20	250
35C15	2.798	107	4	-03.2006	8140.43N	; Engine No. >3487099	EPBBPT4-V005Z	93700	20	250
35C15V, 35S15V	2.798	107	4	-03.2006	8140.43N	; Engine No. <3487098	EPBBPT4-V012Z	96542	20	250
35C15V, 35S15V	2.798	107	4	-03.2006	8140.43N	; Engine No. >3487099	EPBBPT4-V005Z	93700	20	250
40C15	2.798	107	4	04.2003-09.2004	8140.43N	; Engine No. <3487098	EPBBPT4-V012Z	96542	20	250
40C15	2.798	107	4	04.2003-09.2004	8140.43N	; Engine No. >3487099	EPBBPT4-V005Z	93700	20	250



MAP



l kW
C
Y
I



Type-N°

Stock-N°

kPa from
kPa to

IVECO

DAILY III

40C15	2.798	107	4	04.2003-09.2004	8140.43N	; Engine No. <3487098	EPBBPT4-V012Z	96542	20	250
40C15	2.798	107	4	04.2003-09.2004	8140.43N	; Engine No. >3487099	EPBBPT4-V005Z	93700	20	250
50C15	2.798	107	4	-09.2004	8140.43N	; Engine No. <3487098	EPBBPT4-V012Z	96542	20	250
50C15	2.798	107	4	-09.2004	8140.43N	; Engine No. >3487099	EPBBPT4-V005Z	93700	20	250
65C15	2.798	107	4	-09.2004	8140.43N	; Engine No. <3487098	EPBBPT4-V012Z	96542	20	250
65C15	2.798	107	4	-09.2004	8140.43N	; Engine No. >3487099	EPBBPT4-V005Z	93700	20	250
35C14	2.998	100	4	09.2004-04.2006	F1CE0481A, F1CE0481E		EPBBPT4-V001Z	92565	11	307
40C14	2.998	100	4	09.2004-04.2006	F1CE0481A		EPBBPT4-V001Z	92565	11	307
50C14	2.998	100	4	09.2004-04.2006	F1CE0481A, F1CE0481E		EPBBPT4-V001Z	92565	11	307
65C14	2.998	100	4	09.2004-04.2006	F1CE0481A, F1CE0481E		EPBBPT4-V001Z	92565	11	307
35C17, 35S17	2.998	122	4	01.2005-04.2006	F1CE0481B		EPBBPT4-V001Z	92565	11	307
40C17, 40S17	2.998	122	4	01.2005-04.2006	F1CE0481B		EPBBPT4-V001Z	92565	11	307
50C17	2.998	122	4	09.2004-04.2006	F1CE0481B		EPBBPT4-V001Z	92565	11	307
65C17	2.998	122	4	09.2004-04.2006	F1CE0481B		EPBBPT4-V001Z	92565	11	307

DAILY IV

29L10	2.287	70	4	05.2006-08.2011	F1AE0481F		EPBBPT4-V001Z	92565	11	307
35C10, 35S10	2.287	70	4	05.2006-08.2011	F1AE0481F		EPBBPT4-V001Z	92565	11	307
40C10	2.287	70	4	05.2006-08.2011	F1AE0481F		EPBBPT4-V001Z	92565	11	307
35C11, 35S11	2.287	78	4	07.2007-08.2011	F1AE0481U		EPBBPT4-V001Z	92565	11	307
40C11	2.287	78	4	07.2007-08.2011	F1AE0481U		EPBBPT4-V001Z	92565	11	307
29L12	2.287	85	4	05.2006-08.2011	F1AE0481G		EPBBPT4-V001Z	92565	11	307
35C12, 35S12	2.287	85	4	05.2006-08.2011	F1AE0481G, F1AE0481R		EPBBPT4-V001Z	92565	11	307
40C12, 40C14	2.287	85	4	05.2006-08.2011	F1AE0481G		EPBBPT4-V001Z	92565	11	307
35C13, 35S13	2.287	93	4	07.2007-08.2011	F1AE0481V		EPBBPT4-V001Z	92565	11	307
40C13	2.287	93	4	07.2007-08.2011	F1AE0481V		EPBBPT4-V001Z	92565	11	307
29L14	2.287	100	4	05.2006-08.2011	F1AE0481H		EPBBPT4-V001Z	92565	11	307
35C14, 35S14	2.287	100	4	05.2006-08.2011	F1AE0481H		EPBBPT4-V001Z	92565	11	307
35C14G, 35S14G	2.998	100	4	07.2007-08.2011	F1CE0441A		EPBBPT4-V001Z	92565	11	307
40C14G	2.998	100	4	07.2007-08.2011	F1CE0441A		EPBBPT4-V001Z	92565	11	307
50C14G	2.998	100	4	07.2007-08.2011	F1CE0441A		EPBBPT4-V001Z	92565	11	307
65C14G	2.998	100	4	07.2007-08.2011	F1CE0441A		EPBBPT4-V001Z	92565	11	307
35C14, 35S14	2.998	103	4	09.2009-08.2011	F1CE3481L		EPBBPT4-V001Z	92565	11	307
40C14	2.998	103	4	09.2009-08.2011	F1CE3481L		EPBBPT4-V001Z	92565	11	307
45C14	2.998	103	4	09.2009-08.2011	F1CE3481L		EPBBPT4-V001Z	92565	11	307
50C14	2.998	103	4	09.2009-08.2011	F1CE3481L		EPBBPT4-V001Z	92565	11	307
60C14	2.998	103	4	09.2009-08.2011	F1CE3481L		EPBBPT4-V001Z	92565	11	307



MAP



l kW
C
Y
I



Type-N°

Stock-N°

kPa from

kPa to

IVECO

DAILY IV

65C14	2.998	103	4	09.2009-08.2011	F1CE3481L		EPBBPT4-V001Z	92565	11	307
70C14	2.998	103	4	09.2009-08.2011	F1CE3481L		EPBBPT4-V001Z	92565	11	307
35C15	2.998	107	4	05.2006-08.2011	F1CE0481F		EPBBPT4-V001Z	92565	11	307
40C15	2.998	107	4	05.2006-08.2011	F1CE0481F		EPBBPT4-V001Z	92565	11	307
45C15	2.998	107	4	05.2006-08.2011	F1CE0481F		EPBBPT4-V001Z	92565	11	307
50C15	2.998	107	4	05.2006-08.2011	F1CE0481F		EPBBPT4-V001Z	92565	11	307
60C15	2.998	107	4	05.2006-08.2011	F1CE0481F		EPBBPT4-V001Z	92565	11	307
65C15	2.998	107	4	05.2006-08.2011	F1CE0481F		EPBBPT4-V001Z	92565	11	307
35C17, 35S17	2.998	125	4	07.2007-08.2011	F1CE3481C		EPBBPT4-V001Z	92565	11	307
40C17	2.998	125	4	07.2007-08.2011	F1CE3481C		EPBBPT4-V001Z	92565	11	307
45C17	2.998	125	4	07.2007-08.2011	F1CE3481C		EPBBPT4-V001Z	92565	11	307
50C17	2.998	125	4	07.2007-08.2011	F1CE3481C		EPBBPT4-V001Z	92565	11	307
55S17	2.998	125	4	07.2007-08.2011	F1CE3481C		EPBBPT4-V001Z	92565	11	307
65C17	2.998	125	4	07.2007-08.2011	F1CE3481C		EPBBPT4-V001Z	92565	11	307
70C17	2.998	125	4	07.2007-08.2011	F1CE3481C		EPBBPT4-V001Z	92565	11	307
35C18, 35S18	2.998	130	4	05.2006-08.2011	F1CE0481H		EPBBPT4-V001Z	92565	11	307
40C18	2.998	130	4	05.2006-08.2011	F1CE0481H		EPBBPT4-V001Z	92565	11	307
45C18	2.998	130	4	05.2006-08.2011	F1CE0481H		EPBBPT4-V001Z	92565	11	307
50C18	2.998	130	4	05.2006-08.2011	F1CE0481H		EPBBPT4-V001Z	92565	11	307
60C18	2.998	130	4	05.2006-08.2011	F1CE0481H		EPBBPT4-V001Z	92565	11	307
65C18	2.998	130	4	05.2006-08.2011	F1CE0481H		EPBBPT4-V001Z	92565	11	307

DAILY V

26L11, 29L11, 35C11, 35S11, 40C11	2.287	78	4	09.2011-02.2014	F1AE3481A		EPBBPT4-V001Z	92565	11	307
29L13, 35C13, 35S13, 40C13, 40S13	2.287	93	4	09.2011-02.2014	F1AE3481B		EPBBPT4-V001Z	92565	11	307
29L15, 35S15, 35C15L, 40C15L, 50C15L	2.287	107	4	09.2011-02.2014	F1AE3481C		EPBBPT4-V001Z	92565	11	307
35C15, 35S15, 40C15, 45C15, 50C15, 60C15, 65C15, 70C15	2.998	107	4	09.2011-02.2014	F1CE3481B, F1CE3481J		EPBBPT4-V001Z	92565	11	307
35C17, 35S17, 40C17, 45C17, 50C17, 60C17, 70C17	2.998	125	4	09.2011-02.2014	F1CE3481C, F1CE3481K		EPBBPT4-V001Z	92565	11	307

DAILY VI

NaturalPower 35C14, 35S14, 40C14, 50C14, 65C14, 70C14	2.998	100	4	03.2014-	F1CFA401A		EPBBPT4-V010Z	91257	20	250
---	-------	-----	---	----------	-----------	--	---------------	-------	----	-----

MASSIF

3.0 HPI	2.998	107	4	10.2008-02.2011	F1CE0481F		EPBBPT4-V001Z	92565	11	307
3.0 HPT	2.998	130	4	10.2008-02.2011	F1CE0481H		EPBBPT4-V001Z	92565	11	307

JAGUAR

F-PACE (X761)

3.0 SCV6 AWD	2.995	250	6	09.2015-	306PS		EPBBPT4-V009Z	95675	20	300
3.0 SCV6 AWD	2.995	280	6	09.2015-	306PS		EPBBPT4-V009Z	95675	20	300

XE (X760)

2.0	1.999	147	4	03.2015-	204PT		EPBMPN3-V019Z	93061	10	307,5
-----	-------	-----	---	----------	-------	--	---------------	-------	----	-------



MAP

 kW
C
Y
I

Type-N°

Stock-N°

 kPa from
kPa to

JAGUAR
XE (X760)

2.0	1.999	177	4	03.2015-	204PT		EPBMPN3-V019Z	93061	10	307,5
-----	-------	-----	---	----------	-------	--	---------------	-------	----	-------

XF I (X250)

2.0	1.999	177	4	06.2012-04.2015	204PT		EPBMPN3-V019Z	93061	10	307,5
2.2 D	2.179	120	4	04.2011-04.2015	224DT		EPBBPN3-A018Z	95753	35	320
2.2 D	2.179	140	4	05.2011-04.2015	224DT		EPBBPN3-A018Z	95753	35	320
2.2 D	2.179	147	4	03.2012-04.2015	224DT		EPBBPN3-A018Z	95753	35	320
5.0 Kompressor	5.000	346	8	09.2009-08.2010	508PS		EPBBPT4-V009Z	95675	20	300
5.0 Kompressor	5.000	375	8	09.2009-08.2010	508PS		EPBBPT4-V009Z	95675	20	300
5.0 XFR-S	5.000	405	8	10.2012-04.2015	508PS		EPBBPT4-V009Z	95675	20	300

XF II (X260)

2.0	1.999	177	4	05.2015-	204PT		EPBMPN3-V019Z	93061	10	307,5
3.0	2.995	250	6	05.2015-	306PS		EPBBPT4-V009Z	95675	20	300
3.0 AWD	2.995	250	6	07.2015-	306PS		EPBBPT4-V009Z	95675	20	300
3.0	2.995	280	6	05.2015-	306PS		EPBBPT4-V009Z	95675	20	300
3.0 AWD	2.995	280	6	07.2015-	306PS		EPBBPT4-V009Z	95675	20	300

XF SPORTBRAKE (X250)

2.2 D	2.179	120	4	09.2012-04.2014	224DT		EPBBPN3-A018Z	95753	35	320
2.2 D	2.179	147	4	09.2012-04.2014	224DT		EPBBPN3-A018Z	95753	35	320
3.0 D	2.993	177	6	09.2012-04.2014	306DT	; For engines with secondary air intake	EPBBPN3-A031Z	95922	40	250
3.0 D	2.993	202	6	09.2012-04.2014	306DT	; For engines with secondary air intake	EPBBPN3-A031Z	95922	40	250

XJ (X350, X358)

D 2.7	2.720	152	6	10.2005-03.2009	AJD	; For engines with secondary air intake	EPBBPN3-A031Z	95922	40	250
3.0	2.967	175	6	05.2003-03.2009	AJ-V6	; For engines with secondary air intake	EPBBPN3-A031Z	95922	40	250
3.0	2.967	179	6	04.2004-01.2007	AJ-V6	; For engines with secondary air intake	EPBBPN3-A031Z	95922	40	250
3.6	3.555	190	8	05.2003-03.2009	RG (AJ-V8)	; For engines with secondary air intake	EPBBPN3-A031Z	95922	40	250
4.2	4.196	219	8	05.2003-03.2009	AJ8FT	; For engines with secondary air intake	EPBBPN3-A031Z	95922	40	250

XJ (X351)

2.0 Ti4	1.999	177	4	05.2012-	204PT		EPBMPN3-V019Z	93061	10	307,5
3.0 V6	2.967	175	6	01.2011-	AJ-V6	; For engines with secondary air intake	EPBBPN3-A031Z	95922	40	250
5.0 SCV8	5.000	346	8	10.2009-	508PS		EPBBPT4-V009Z	95675	20	300
5.0 SCV8	5.000	375	8	10.2009-	508PS		EPBBPT4-V009Z	95675	20	300

XK (X150)

3.6	3.555	190	8	07.2007-07.2014	RG (AJ-V8)	; For engines with secondary air intake	EPBBPN3-A031Z	95922	40	250
-----	-------	-----	---	-----------------	------------	---	---------------	-------	----	-----



MAP



l kW
C
Y
I



Type-Nº

Stock-Nº

kPa from

kPa to

JAGUAR

XK (X150)

4.2 XK8	4.196	219	8	03.2006-07.2014	AJ8FT	; For engines with secondary air intake	EPBBPN3-A031Z	95922	40	250
5.0 V8	5.000	283	8	01.2009-07.2014	508PN		EPBBPT4-V009Z	95675	20	300
5.0 XKR	5.000	375	8	01.2009-07.2014	508PS		EPBBPT4-V009Z	95675	20	300
5.0 XKR-S	5.000	405	8	01.2011-07.2014	508PS		EPBBPT4-V009Z	95675	20	300

X-TYPE (X400)

2.0 D	1.998	96	4	07.2003-11.2009	R4-X404	; Chass. <E43463	EPBMPT4-V002Z	94153	40	261
2.2 D	2.198	110	4	10.2005-11.2009	QJBA	; Chass. <E43463	EPBMPT4-V002Z	94153	40	261

JEEP

CHEROKEE (XJ)

2.1 TD	2.068	59	4	06.1989-03.1992	J8S		EPBMPN3-A003Z	92477	15	102
2.1 D 4x4	2.068	59	4	10.1986-09.1992	J8S 742		EPBMPN3-A003Z	92477	15	102

COMMANDER (XK, XH)

3.0 CRD 4x4	2.987	160	6	04.2006-12.2010	EXL		EPBBPN3-A011Z	91149	50	310
-------------	-------	-----	---	-----------------	-----	--	---------------	-------	----	-----

COMPASS (MK49)

2.2 CRD	2.143	100	4	05.2011-	ENE		EPBMPN3-A004Z	90833	10	120
2.2 CRD 4x4	2.143	100	4	05.2011-	ENE		EPBMPN3-A004Z	90833	10	120
2.2 CRD 4x4	2.143	120	4	12.2010-	OM 651.925	; Position: Suction Pipe	EPBMPN3-A004Z	90833	10	120

GRAND CHEROKEE III (WH, WK)

3.0 CRD 4x4	2.987	155	6	05.2006-12.2010	EXL		EPBBPN3-A011Z	91149	50	310
3.0 CRD 4x4	2.987	160	6	06.2005-12.2010	EXL		EPBBPN3-A011Z	91149	50	310

PATRIOT (MK74)

2.2 CRD	2.143	100	4	01.2011-12.2017	ENE		EPBMPN3-A004Z	90833	10	120
2.2 CRD 4x4	2.143	100	4	01.2011-12.2017	ENE		EPBMPN3-A004Z	90833	10	120
2.2 CRD 4x4	2.143	120	4	01.2011-12.2017	ENE		EPBMPN3-A004Z	90833	10	120

WRANGLER I (YJ, SJ_)

2.5	2.464	76	4	01.1988-12.1991	E246L		EPBMPN3-A003Z	92477	15	102
2.5	2.464	89	4	12.1991-08.1996	EPE		EPBMPN3-A003Z	92477	15	102
4.0	3.964	131	6	12.1991-08.1996	ERH		EPBMPN3-A003Z	92477	15	102

WRANGLER II (TJ)

2.5	2.464	87	4	08.1996-04.2007	P00		EPBMPN3-A003Z	92477	15	102
4.0 Rubicon	3.964	128	6	08.2003-04.2007	ERH		EPBMPN3-A003Z	92477	15	102
4.0	3.960	130	6	08.1996-04.2007	S01		EPBMPN3-A003Z	92477	15	102

WRANGLER III (JK)

2.8 CRD	2.777	130	4	-12.2010	ENS	; Position: Suction Pipe	EPBMPN3-A004Z	90833	10	120
2.8 CRD	2.776	147	4	-12.2010	ENS	; Position: Suction Pipe	EPBMPN3-A004Z	90833	10	120

KIA

BONGO

2.4 TDCi	2.477	69	4	10.2003-	D4BH		EPBBPT4-V007Z	94941	20	250
----------	-------	----	---	----------	------	--	---------------	-------	----	-----



MAP



l kW
C
Y
I



Type-N°

Stock-N°

kPa from
kPa to

KIA

CARENS II (FJ)

1.6	1.594	77	4	07.2002-	GA6D		EPBMPT4-V033Z	90173		
-----	-------	----	---	----------	------	--	---------------	-------	--	--

CARENS III (UN)

1.6 CVVT	1.591	97	4	08.2009-	G4FC		EPBMPT4-V018Z	95148	10	120
1.6 CVVT	1.591	93	4	10.2010-	G4FC		EPBMPT4-V018Z	95148	10	120
1.6 CRDi 128	1.582	94	4	10.2010-	D4FB		EPBMPT4-V014Z	97115	25	950

CARENS IV

1.6 GDi	1.591	99	4	03.2013-	G4FD		EPBMPT4-V018Z	95148	10	120
2.0 GDi	1.999	122	4	03.2013-	G4NC		EPBMPT4-V018Z	95148	10	120

CARNIVAL / GRAND CARNIVAL III (VQ) | SEDONA

2.7 V6	2.656	139	6	-05.2009	G6EA		EPBMPN3-V030Z	92953	10	115
--------	-------	-----	---	----------	------	--	---------------	-------	----	-----

CEE'D / PRO CEE'D (ED)

1.4 LPG	1.396	64	4	06.2011-04.2012	G4FA		EPBMPT4-V018Z	95148	10	120
1.4 CVVT	1.396	66	4	07.2009-12.2012	G4FA		EPBMPT4-V018Z	95148	10	120
1.4	1.396	77	4	12.2006-12.2012	G4FA		EPBMPT4-V018Z	95148	10	120
1.4	1.396	80	4	12.2006-12.2012	G4FA		EPBMPT4-V018Z	95148	10	120
1.4 LPG	1.396	80	4	01.2009-12.2010	G4FA		EPBMPT4-V018Z	95148	10	120
1.6 CRDi 90	1.582	66	4	02.2008-09.2012	D4FBL	; With Charger Intercooler	EPBMPT4-V014Z	97115	25	950
1.6	1.591	85	4	09.2007-12.2012	G4FC		EPBMPT4-V018Z	95148	10	120
1.6 CRDi 115	1.582	85	4	02.2008-09.2012	D4FB	; With Charger Intercooler	EPBMPT4-V014Z	97115	25	950
1.6 LPG	1.591	87	4	06.2011-12.2011	G4FC		EPBMPT4-V018Z	95148	10	120
1.6	1.591	90	4	12.2006-12.2012	G4FC		EPBMPT4-V018Z	95148	10	120
1.6 LPG	1.591	91	4	06.2007-09.2012	G4FC		EPBMPT4-V018Z	95148	10	120
1.6 CVVT	1.591	92	4	06.2009-12.2012	G4FC		EPBMPT4-V018Z	95148	10	120
1.6	1.591	93	4	09.2007-12.2012	G4FC		EPBMPT4-V018Z	95148	10	120
1.6 CRDi 128	1.582	94	4	10.2010-09.2012	D4FB	; With Charger Intercooler	EPBMPT4-V014Z	97115	25	950
2.0	1.975	105	4	12.2006-12.2012	G4GC		EPBMPT4-V039Z	96769	10	115
2.0 LPG	1.975	105	4	01.2009-12.2009	G4GC		EPBMPT4-V039Z	96769	10	115

CEE'D / PRO CEE'D (JD)

1.0 T-GDI	998	74	3	04.2015-	G3LC		EPBMPT4-V014Z	97115	25	950
1.0 T-GDI	998	88	3	07.2015-	G3LC		EPBMPT4-V014Z	97115	25	950
1.4 CVVT	1.396	66	4	05.2012-	G4FA		EPBMPT4-V018Z	95148	10	120
1.4 CRDi	1.396	66	4	04.2015-	D4FC		EPBMBN3-V006Z	94835	18,2	300,2
1.4 LPG	1.396	72	4	01.2013-	G4FA		EPBMPT4-V018Z	95148	10	120
1.4 CVVT	1.396	73	4	05.2012-	G4FA		EPBMPT4-V018Z	95148	10	120
1.4 MPI	1.368	74	4	04.2015-	G4LC		EPBMPT4-V018Z	95148	10	120
1.6 CVVT	1.591	92	4	05.2012-	G4FC	; Position: Intake Manifold	EPBMPT4-V014Z	97115	25	950
1.6 CVVT	1.591	92	4	05.2012-	G4FC	; Position: Intake Manifold	EPBMPT4-V018Z	95148	10	120
1.6 CRDi	1.582	94	4	10.2012-	D4FB	; Euro 5; Euro 6	EPBMBN3-V006Z	94835	18,2	300,2



MAP



l kW
C
Y
I



Type-Nº

Stock-Nº

kPa from

kPa to

KIA

CEE'D / PRO CEE'D (JD)

1.6 CVVT	1.591	95	4	01.2013-	G4FC		EPBMPT4-V018Z	95148	10	120
1.6 CVVT	1.591	96	4	11.2014-	G4FC		EPBMPT4-V018Z	95148	10	120
1.6 GDI	1.591	99	4	05.2012-	G4FD		EPBMPT4-V018Z	95148	10	120
1.6 CRDi 136	1.582	100	4	07.2015-	D4FB		EPBMBN3-V006Z	94835	18,2	300,2
1.6 GT	1.591	150	4	06.2013-	G4FJ		EPBMPT4-V014Z	97115	25	950

CEED / PROCEED (GD)

1.0 T-GDI	998	88	3	03.2018-	G3LC		EPBMPT4-V014Z	97115	25	950
1.4 LPG	1.368	71	4	12.2018-	G4LC		EPBMPT4-V018Z	95148	10	120
1.4	1.368	73	4	03.2018-	G4LC		EPBMPT4-V018Z	95148	10	120
1.4 T-GDI	1.353	103	4	03.2018-	G4LD		EPBMPT4-V014Z	97115	25	950
1.6 CRDi 115	1.598	85	4	03.2018-	D4FE		EPBMBN3-V006Z	94835	18,2	300,2
1.6	1.591	94	4	03.2018-	G4FG		EPBMPT4-V018Z	95148	10	120
1.6 CRDi 136	1.598	100	4	03.2018-	D4FE		EPBMBN3-V006Z	94835	18,2	300,2
1.6 T-GDI	1.591	147	4	10.2018-	G4FJ		EPBMPT4-V014Z	97115	25	950
1.6 T-GDI GT	1.591	150	4	10.2018-	G4FJ		EPBMPT4-V014Z	97115	25	950

CERATO I (LD)

1.5 CRDi	1.493	66	4	07.2005-12.2009	D4FA	; Position: Intake Manifold	EPBBPT4-V007Z	94941	20	250
1.5 CRDi	1.493	75	4	07.2005-	D4FA	; Position: Intake Manifold	EPBBPT4-V007Z	94941	20	250
1.6	1.599	77	4	-09.2006	G4ED		EPBMPT4-V039Z	96769	10	115
1.6	1.599	77	4	10.2006-	G4ED		EPBMPT4-V018Z	95148	10	120
1.6	1.599	90	4	04.2004-01.2007	G4GR		EPBMPT4-V018Z	95148	10	120
1.6	1.591	90	4	05.2006-12.2009	G4FC		EPBMPT4-V018Z	95148	10	120
2.0	1.975	105	4	03.2004-05.2007	G4GC		EPBMPT4-V039Z	96769	10	115

CERATO II (TD)

1.6	1.591	90	4	01.2010-	G4FC		EPBMPT4-V018Z	95148	10	120
1.6 CVVT	1.591	91	4	02.2009-	G4FC		EPBMPT4-V018Z	95148	10	120
1.6	1.591	93	4	01.2010-06.2013	G4FC		EPBMPT4-V018Z	95148	10	120
2.0 CVVT	1.998	110	4	07.2009-06.2013	G4KD		EPBMPT4-V018Z	95148	10	120
2.0	1.998	115	4	01.2009-	G4KD		EPBMPT4-V018Z	95148	10	120

CERATO III (YD)

1.6 MPi	1.591	96	4	06.2013-	G4FC		EPBMPT4-V018Z	95148	10	120
1.6 T-GDI	1.591	150	4	12.2013-	G4FJ		EPBMPT4-V014Z	97115	25	950
2.0 MPi	1.997	110	4	06.2013-	G4KD		EPBMPT4-V018Z	95148	10	120
2.0 MPi	1.999	112	4	03.2016-	G4NA		EPBMPT4-V018Z	95148	10	120

K2500 (SD) | FRONTIER

2.5 D	2.476	69	4	01.2003-	D4BH		EPBBPT4-V007Z	94941	20	250
2.5 CRDi	2.497	96	4	01.2010-	D4CB		EPBBPT4-V007Z	94941	20	250



MAP



l kW
C
Y
I



Type-N°

Stock-N°

kPa from
kPa to

KIA

MAGENTIS (GD, MS)

2.0	1.997	100	4	05.2001-09.2005	G4JP		EPBMPT4-V039Z	96769	10	115
-----	-------	-----	---	-----------------	------	--	---------------	-------	----	-----

MAGENTIS (MG) | LOTZE

2.0 CRDi	1.991	100	4	11.2005-12.2008	D4EA	; With Charger Intercooler	EPBMPT4-V014Z	97115	25	950
2.0	1.998	121	4	09.2009-	G4KD		EPBMPT4-V018Z	95148	10	120
2.7	2.656	138	6	11.2005-	G6EA		EPBMPN3-V030Z	92953	10	115
2.7 V6	2.656	142	6	07.2009-	G6EA		EPBMPN3-V030Z	92953	10	115

OPIRUS (GH)

3.5	3.497	149	6	09.2003-	G6CU		EPBMPN3-V030Z	92953	10	115
3.8 V6	3.778	196	6	10.2006-	G6DA		EPBMPN3-V030Z	92953	10	115

OPTIMA

2.0 CVVT	1.998	110	4	01.2011-12.2015	G4KD		EPBMPT4-V018Z	95148	10	120
2.0 CVVT Hybrid	1.999	110	4	03.2012-	G4NE		EPBMPT4-V018Z	95148	10	120
2.0 CVVL	1.998	121	4	03.2012-	G4KD		EPBMPT4-V018Z	95148	10	120
2.0 CVVT	1.999	121	4	03.2013-12.2015	G4NA		EPBMPT4-V018Z	95148	10	120
2.0	1.998	125	4	03.2012-	G4KD		EPBMPT4-V018Z	95148	10	120
2.4	2.359	132	4	03.2012-	G4KJ	; Position: Intake Manifold	EPBMPT4-V018Z	95148	10	120
2.4	2.359	149	4	09.2010-	G4KJ	; Position: Intake Manifold	EPBMPT4-V018Z	95148	10	120

OPTIMA (JF)

1.6 CRDi	1.598	100	4	01.2018-	D4FE		EPBMBN3-V006Z	94835	18,2	300,2
1.6 T-GDI	1.591	132	4	09.2018-	G4FJ		EPBMPT4-V014Z	97115	25	950
1.7 CRDi	1.685	99	4	09.2016-	D4FD		EPBMBN3-V006Z	94835	18,2	300,2
1.7 CRDi	1.685	104	4	11.2015-	D4FD		EPBMBN3-V006Z	94835	18,2	300,2
2.0	1.999	110	4	09.2015-	G4ND		EPBMPT4-V018Z	95148	10	120
2.0 GDI Hybrid	1.999	115	4	09.2016-	G4NG		EPBMPT4-V018Z	95148	10	120
2.0 CVVL	1.999	120	4	09.2015-	G4ND		EPBMPT4-V018Z	95148	10	120
2.0 GDI Hybrid	1.999	151	4	09.2016-	G4NG		EPBMPT4-V018Z	95148	10	120
2.0 T-GDi GT	1.998	175	4	01.2018-	G4KH		EPBMPT4-V014Z	97115	25	950
2.0 T-GDi	1.998	180	4	09.2015-	G4KH		EPBMPT4-V014Z	97115	25	950
2.4 GDI	2.359	138	4	09.2015-	G4KJ		EPBMPT4-V018Z	95148	10	120

PICANTO (JA)

1.0 T-GDi	998	74	3	03.2017-	G3LC		EPBMPT4-V014Z	97115	25	950
-----------	-----	----	---	----------	------	--	---------------	-------	----	-----

PICANTO (SA)

1.0	999	45	4	04.2004-	G4HE		EPBMPT4-V039Z	96769	10	115
1.0 LPG	999	45	4	01.2009-04.2011	G4HE		EPBMPT4-V039Z	96769	10	115
1.0	999	46	4	09.2007-	G4HE		EPBMPT4-V039Z	96769	10	115
1.1	1.086	48	4	04.2004-	G4HG		EPBMPT4-V039Z	96769	10	115
1.1 LPG	1.086	48	4	01.2009-04.2011	G4HG		EPBMPT4-V039Z	96769	10	115

PICANTO (TA)

1.0 LPG	998	49	3	08.2013-	B3LA		EPBMPT4-V018Z	95148	10	120
---------	-----	----	---	----------	------	--	---------------	-------	----	-----



MAP



l kW C Y I



Type-N°

Stock-N°

kPa from

kPa to

KIA

PICANTO (TA)

1.0	998	51	3	05.2011-	G3LA		EPBMPT4-V018Z	95148	10	120
1.0 Bi-Fuel	998	60	3	05.2011-	B3LA		EPBMPT4-V018Z	95148	10	120
1.2	1.248	63	4	09.2011-	G4LA		EPBMPT4-V018Z	95148	10	120
1.2	1.248	64	4	09.2011-02.2017	G4LA		EPBMPT4-V018Z	95148	10	120

PREGIO BOX (TB)

2.5 TDi D	2.476	69	4	09.2002-	D4BH		EPBBPT4-V007Z	94941	20	250
-----------	-------	----	---	----------	------	--	---------------	-------	----	-----

PREGIO BUS

2.5 D	2.477	69	4	08.1995-09.2004	D4BH		EPBBPT4-V007Z	94941	20	250
-------	-------	----	---	-----------------	------	--	---------------	-------	----	-----

PRIDE (DA)

1.3	1.324	44	4	01.1990-10.2000	B3A6		EPBMPN3-A003Z	92477	15	102
1.3	1.324	47	4	10.1996-05.2001	B3A5		EPBMPN3-A003Z	92477	15	102
1.3 16V	1.324	53	4	01.1990-09.2001	B3A7		EPBMPN3-A003Z	92477	15	102

QUORIS

3.8	3.778	216	6	03.2017-	G6DK		EPBMPN3-V030Z	92953	10	115
5.0 GDI	5.038	312	8	05.2015-	G8BE		EPBMPT4-V018Z	95148	10	120

RIO (DC_)

1.3	1.343	55	4	09.2000-02.2005	A3E		EPBMPT4-V033Z	90173		
1.5 16V	1.493	72	4	09.2000-02.2005	A5D		EPBMPT4-V033Z	90173		

RIO II (JB)

1.4	1.399	55	4	01.2010-12.2011	G4EE		EPBMPT4-V039Z	96769	10	115
1.4 16V	1.399	71	4	03.2005-	G4EE		EPBMPT4-V039Z	96769	10	115
1.6 CVVT	1.599	82	4	03.2005-	G4ED		EPBMPT4-V039Z	96769	10	115

RIO III (UB)

1.2	1.248	51	4	09.2011-	G4LA		EPBMPT4-V018Z	95148	10	120
1.2 CVVT	1.248	62	4	11.2014-	G4LA	;	EPBMPT4-V018Z	95148	10	120
1.2 CVVT	1.248	62	4	11.2014-	G4LA	;	EPBMPT4-V018Z	95148	10	120
1.25 LPG	1.248	63	4	09.2011-	G4LA		EPBMPT4-V018Z	95148	10	120
1.2 CVVT	1.248	63	4	04.2015-	G4LA		EPBMPT4-V018Z	95148	10	120
1.25 CVVT	1.248	63	4	09.2011-	G4LA	;	EPBMPT4-V018Z	95148	10	120
1.25 CVVT	1.248	63	4	09.2011-	G4LA	;	EPBMPT4-V018Z	95148	10	120
1.2 CVVT	1.248	64	4	11.2014-	G4LA	;	EPBMPT4-V018Z	95148	10	120
1.2 CVVT	1.248	64	4	11.2014-	G4LA	;	EPBMPT4-V018Z	95148	10	120
1.25 CVVT	1.248	65	4	09.2011-	G4LA	; Position: Intake Manifold	EPBMPT4-V018Z	95148	10	120
1.4 CRDi	1.396	66	4	04.2015-	D4FC		EPBMBN3-V006Z	94835	18,2	300,2
1.4 CVVT	1.396	79	4	06.2011-	G4FA		EPBMPT4-V018Z	95148	10	120
1.4 CVVT	1.396	80	4	09.2011-	G4FA		EPBMPT4-V018Z	95148	10	120
1.6 CVVT	1.591	90	4	06.2012-	G4FC		EPBMPT4-V018Z	95148	10	120

RIO IV (YB, SC, FB)

1.0 T-GDI 100	998	74	3	01.2017-	G3LC		EPBMPT4-V014Z	97115	25	950
---------------	-----	----	---	----------	------	--	---------------	-------	----	-----



MAP



l kW
C
Y
I



Type-N°

Stock-N°

kPa from
kPa to

KIA

RIO IV (YB, SC, FB)

1.0 T-GDI 120	998	88	3	01.2017-	G3LC		EPBMPT4-V014Z	97115	25	950
1.25	1.248	62	4	01.2017-	G4LA		EPBMPT4-V018Z	95148	10	120
1.4	1.368	73	4	01.2017-	G4LC		EPBMPT4-V018Z	95148	10	120
1.4	1.368	74	4	01.2017-	G4LC		EPBMPT4-V018Z	95148	10	120
1.4 CRDi 77	1.396	57	4	01.2017-	D4FC		EPBMBN3-V006Z	94835	18,2	300,2
1.4 CRDi 90	1.396	66	4	01.2017-	D4FC		EPBMBN3-V006Z	94835	18,2	300,2
1.6	1.591	90	4	01.2017-	G4FG		EPBMPT4-V018Z	95148	10	120

SEPHIA (FA) | MENTOR

1.5 i	1.498	59	4	02.1996-10.1997	B5		EPBMPN3-A003Z	92477	15	102
-------	-------	----	---	-----------------	----	--	---------------	-------	----	-----

SHUMA (FB)

1.5	1.498	59	4	03.1996-12.1998	B5		EPBMPN3-A003Z	92477	15	102
1.5 i 16V	1.498	65	4	10.1997-03.2001	BFD		EPBMPN3-A003Z	92477	15	102
1.6	1.594	75	4	05.2001-08.2004	GA6D		EPBMPT4-V033Z	90173		
1.6	1.594	75	4	05.2001-05.2004	GA6D		EPBMPT4-V033Z	90173		

SORENTO I (JC)

2.4	2.351	102	4	08.2002-	G4JS		EPBMPN3-V030Z	92953	10	115
3.3 V6 4WD	3.342	182	6	02.2007-	G6DB		EPBMPN3-V030Z	92953	10	115
3.5 V6 4WD	3.497	143	6	08.2002-	G6CU		EPBMPN3-V030Z	92953	10	115

SORENTO II (XM)

2.4 LPG	2.359	126	4	04.2010-12.2015	G4KE		EPBMPT4-V018Z	95148	10	120
2.4 LPG 4WD	2.359	126	4	04.2010-12.2015	G4KE		EPBMPT4-V018Z	95148	10	120
2.4 CVVT	2.359	128	4	11.2009-	G4KE		EPBMPT4-V018Z	95148	10	120
2.4 CVVT 4WD	2.359	128	4	11.2009-	G4KE		EPBMPT4-V018Z	95148	10	120
2.4 GDI	2.359	141	4	10.2012-	G4KJ		EPBMPT4-V018Z	95148	10	120
2.4 GDI 4WD	2.359	141	4	10.2012-	G4KJ		EPBMPT4-V018Z	95148	10	120

SORENTO III (UM)

2.4	2.359	129	4	01.2015-	G4KE		EPBMPT4-V018Z	95148	10	120
2.4 4WD	2.359	129	4	01.2015-	G4KE		EPBMPT4-V018Z	95148	10	120
2.4 GDI	2.359	138	4	01.2015-	G4KJ		EPBMPT4-V018Z	95148	10	120
2.4 GDI 4WD	2.359	138	4	01.2015-	G4KJ		EPBMPT4-V018Z	95148	10	120
3.5 D-CVVT	3.470	183	6	12.2018-	G6DC		EPBMPT4-V018Z	95148	10	120
3.5 D-CVVT 4WD	3.470	183	6	12.2018-	G6DC		EPBMPT4-V018Z	95148	10	120

SOUL (AM)

1.6 CVVT	1.591	77	4	02.2009-	G4FC		EPBMPT4-V018Z	95148	10	120
1.6 LPG	1.591	87	4	06.2011-12.2014	G4FC		EPBMPT4-V018Z	95148	10	120
1.6 LPG	1.591	92	4	02.2009-12.2014	G4FC		EPBMPT4-V018Z	95148	10	120
1.6 CVVT	1.591	93	4	02.2009-	G4FC		EPBMPT4-V018Z	95148	10	120
1.6 CVVT	1.591	95	4	03.2012-	G4FC		EPBMPT4-V018Z	95148	10	120



MAP



l kW
C
Y
I



Type-N°

Stock-N°

kPa from

kPa to

KIA

SOUL (AM)

1.6 GDI	1.591	103	4	06.2011-	G4FD		EPBMPT4-V018Z	95148	10	120
---------	-------	-----	---	----------	------	--	---------------	-------	----	-----

SOUL II (PS)

1.6 CVVT	1.591	91	4	02.2014-	G4FG		EPBMPT4-V018Z	95148	10	120
1.6 GDI	1.591	97	4	02.2014-	G4FD		EPBMPT4-V018Z	95148	10	120
2.0 CVVT	1.999	110	4	08.2016-	G4NA		EPBMPT4-V018Z	95148	10	120
2.0 CVVT	1.999	113	4	02.2014-	G4NA	; 6-Speed	EPBMPT4-V018Z	95148	10	120

SOUL III (SK3)

1.6 MPi	1.591	91	4	01.2019-	G4FG		EPBMPT4-V018Z	95148	10	120
2.0 MPi	1.999	110	4	01.2019-	G4NA		EPBMPT4-V018Z	95148	10	120

SPORTAGE (JE_, KM_)

2.0 LPG	1.975	101	4	06.2009-05.2010	G4GC		EPBMPT4-V039Z	96769	10	115
2.0 i 16V	1.975	104	4	09.2004-	G4GC	; Position: Intake Manifold	EPBMPT4-V039Z	96769	10	115
2.0 16V 4WD	1.975	104	4	09.2004-	G4GC	; Position: Intake Manifold	EPBMPT4-V039Z	96769	10	115
2.0	1.998	122	4	01.2009-05.2010	G4KD		EPBMPT4-V039Z	96769	10	115

SPORTAGE (QL, QLE)

1.6 CRDi Eco-Dynamics+	1.598	85	4	03.2019-	D4FE		EPBMBN3-V006Z	94835	18,2	300,2
1.6 CRDi	1.598	85	4	07.2018-	D4FE		EPBMBN3-V006Z	94835	18,2	300,2
1.6 GDI	1.591	97	4	09.2015-	G4FD		EPBMPT4-V018Z	95148	10	120
1.6 CRDi Eco-Dynamics+	1.598	100	4	03.2019-	D4FE		EPBMBN3-V006Z	94835	18,2	300,2
1.6 CRDi Eco-Dynamics+ AWD	1.598	100	4	03.2019-	D4FE		EPBMBN3-V006Z	94835	18,2	300,2
1.6 CRDi	1.598	100	4	07.2018-	D4FE		EPBMBN3-V006Z	94835	18,2	300,2
1.6 CRDi AWD	1.598	100	4	07.2018-	D4FE		EPBMBN3-V006Z	94835	18,2	300,2
1.6 T-GDI	1.591	130	4	09.2015-	G4FJ		EPBMPT4-V014Z	97115	25	950
1.6 T-GDI AWD	1.591	130	4	09.2015-	G4FJ		EPBMPT4-V014Z	97115	25	950
1.7 CRDi	1.685	85	4	09.2015-	D4FD		EPBMBN3-V006Z	94835	18,2	300,2
1.7 CRDi	1.685	104	4	11.2016-	D4FD	; Euro 5	EPBMBN3-V006Z	94835	18,2	300,2
2.0	1.999	110	4	12.2015-	G4NA	; Euro 3 (D3)	EPBMPT4-V018Z	95148	10	120
2.0 AWD	1.999	110	4	12.2015-	G4NA		EPBMPT4-V018Z	95148	10	120
2.0	1.999	114	4	12.2015-	G4NA		EPBMPT4-V018Z	95148	10	120
2.0 AWD	1.999	114	4	12.2015-	G4NA		EPBMPT4-V018Z	95148	10	120

SPORTAGE (SL)

1.6 LPG	1.591	99	4	01.2014-12.2015	G4FD		EPBMPT4-V018Z	95148	10	120
1.6 GDI	1.591	99	4	02.2011-	G4FD		EPBMPT4-V018Z	95148	10	120
2.0 CVVT	1.998	110	4	06.2010-12.2013	G4KD		EPBMPT4-V018Z	95148	10	120
2.0 CVVT AWD	1.998	110	4	06.2010-12.2013	G4KD		EPBMPT4-V018Z	95148	10	120
2.0 CVVT	1.999	110	4	01.2014-12.2015	G4NA		EPBMPT4-V018Z	95148	10	120
2.0 CVVT AWD	1.999	110	4	01.2014-12.2015	G4NA		EPBMPT4-V018Z	95148	10	120
2.0 CVVT AWD	1.999	113	4	11.2014-12.2015	G4NA		EPBMPT4-V018Z	95148	10	120



MAP

 e kW
C
Y
I

Type-N°

Stock-N°

 kPa from
kPa to

KIA
SPORTAGE (SL)

2.0 CVVT	1.998	120	4	07.2010-	G4KD		EPBMPT4-V018Z	95148	10	120
2.0 CVVT AWD	1.998	120	4	07.2010-	G4KD		EPBMPT4-V018Z	95148	10	120
2.0 CVVT	1.998	122	4	07.2010-	G4KD		EPBMPT4-V018Z	95148	10	120
2.0 CVVT AWD	1.998	122	4	07.2010-	G4KD		EPBMPT4-V018Z	95148	10	120
2.0 GDI	1.998	122	4	02.2014-	G4NC		EPBMPT4-V018Z	95148	10	120
2.0 GDI AWD	1.998	122	4	02.2014-	G4NC		EPBMPT4-V018Z	95148	10	120

STINGER (CK)

2.0 T-GDI	1.998	145	4	07.2018-	G4KL		EPBMPT4-V014Z	97115	25	950
2.0 T-GDI 4WD	1.998	145	4	07.2018-	G4KL		EPBMPT4-V014Z	97115	25	950
2.0 T-GDI	1.998	180	4	07.2018-	G4KL		EPBMPT4-V014Z	97115	25	950
2.0 T-GDI	1.998	182	4	06.2017-	G4KL		EPBMPT4-V014Z	97115	25	950
2.0 T-GDI 4WD	1.998	182	4	06.2017-	G4KL		EPBMPT4-V014Z	97115	25	950
2.0 T-GDi	1.998	188	4	06.2017-	G4KL		EPBMPT4-V014Z	97115	25	950

STONIC (YB)

1.0 T-GDi	998	74	3	08.2018-	G3LC		EPBMPT4-V014Z	97115	25	950
1.0 T-GDi	998	88	3	07.2017-	G3LC		EPBMPT4-V014Z	97115	25	950
1.2 CVVT	1.248	62	4	07.2017-	G4LA		EPBMPT4-V018Z	95148	10	120
1.4 LPG	1.368	71	4	11.2018-	G4LC		EPBMPT4-V018Z	95148	10	120
1.4 CVVT	1.368	73	4	07.2017-	G4LC		EPBMPT4-V018Z	95148	10	120
1.6 CRDi	1.582	81	4	07.2017-	D4FB		EPBMBN3-V006Z	94835	18,2	300,2
1.6 CRDi	1.598	85	4	08.2018-	D4FE		EPBMBN3-V006Z	94835	18,2	300,2
1.6 CRDi	1.598	100	4	08.2018-	D4FE		EPBMBN3-V006Z	94835	18,2	300,2

VENGA (YN)

CRDi	1.396	57	4	04.2015-	D4FC		EPBMBN3-V006Z	94835	18,2	300,2
1.4 CVVT	1.396	66	4	02.2010-	G4FA		EPBMPT4-V018Z	95148	10	120
1.4 LPG	1.396	66	4	02.2010-	G4FA		EPBMPT4-V018Z	95148	10	120
CRDi	1.396	66	4	04.2015-	D4FC		EPBMBN3-V006Z	94835	18,2	300,2
1.6 CVVT	1.591	92	4	02.2010-	G4FC		EPBMPT4-V018Z	95148	10	120

XCEED (CD)

1.0 T-GDI	998	88	3	06.2019-	G3LC		EPBMPT4-V014Z	97115	25	950
1.4 T-GDI	1.353	103	4	06.2019-	G4LD		EPBMPT4-V014Z	97115	25	950
1.6 CRDi 115	1.598	85	4	06.2019-	D4FE		EPBMBN3-V006Z	94835	18,2	300,2
1.6 CRDi 136	1.598	100	4	06.2019-	D4FE		EPBMBN3-V006Z	94835	18,2	300,2
1.6 T-GDI	1.591	150	4	06.2019-	G4FJ		EPBMPT4-V014Z	97115	25	950

LANCIA
DEDRA (835_)

1.6 i.e.	1.581	57	4	08.1989- 03.1993	835A1.046		EPBMPN3-A002Z	96249	15	100
1.6 LE Cat	1.581	66	4	07.1994- 07.1999	159B9.000		EPBMPN3-A003Z	92477	15	102



MAP



Type-N°
Stock-N°
kPa from
kPa to

LANCIA

DEDRA (835_)

1.6 i.e.	1.581	66	4	08.1989-06.1994	835A1.000		EPBMPN3-A003Z	92477	15	102
1.6 i.e.	1.581	66	4	08.1989-06.1994	835A1.000		EPBMPN3-A002Z	96249	15	100
1.6 16V	1.581	76	4	01.1996-07.1999	182A4.000	; Number of Poles: 4	EPBMPT4-V012Z	91940	20	100
1.6 16V	1.581	76	4	01.1996-07.1999	182A4.000		EPBMPN3-A003Z	92477	15	102
1.8 i.e.	1.756	66	4	08.1993-07.1999	835C5.000		EPBMPN3-A002Z	96249	15	100
1.8 i.e.	1.756	74	4	07.1994-07.1999	836A5.000		EPBMPN3-A002Z	96249	15	100
1.8 i.e.	1.756	77	4	09.1989-07.1999	835A2.046		EPBMPN3-A002Z	96249	15	100
1.8 i.e.	1.756	80	4	09.1989-06.1994	835A2.000		EPBMPN3-A002Z	96249	15	100
2.0 i.e.	1.995	83	4	09.1989-07.1999	835A5.046		EPBMPN3-A002Z	96249	15	100
2.0 i.e.	1.995	86	4	09.1989-07.1992	835A5.000		EPBMPN3-A002Z	96249	15	100
2.0 16V	1.995	102	4	07.1994-07.1999	836A3.000		EPBMPN3-A002Z	96249	15	100

DELTA I (831_)

1.6 GT i.e.	1.585	66	4	05.1987-08.1992	149C2.000		EPBMPN3-A003Z	92477	15	102
1.6 GT i.e.	1.585	80	4	08.1986-08.1988	831B7.000		EPBMPN3-A002Z	96249	15	100
1.6 HF Turbo	1.585	97	4	04.1987-03.1989	831B7.046		EPBMPN3-A003Z	92477	15	102
1.6 HF Turbo	1.585	103	4	08.1986-08.1988	831B3.000		EPBMPN3-A003Z	92477	15	102
2.0 16V HF Evo Integrale	1.995	155	4	06.1993-01.1994	831E5.046		EPBMPN3-A043Z	92940	20	250

DELTA II (836_)

1.6 i.e.	1.581	66	4	03.1996-08.1999	182A6.000		EPBMPN3-A002Z	96249	15	100
1.6 i.e. 16V	1.581	76	4	01.1996-08.1999	182A4.000	; Number of Poles: 4	EPBMPT4-V012Z	91940	20	100
1.6 i.e. 16V	1.581	76	4	01.1996-08.1999	182A4.000		EPBMPN3-A002Z	96249	15	100
2.0 16V	1.995	102	4	06.1993-08.1999	836A3.000		EPBMPN3-A002Z	96249	15	100
2.0 16V Turbo	1.995	137	4	06.1993-08.1999	836A2.000		EPBMPN3-A043Z	92940	20	250
2.0 16V Turbo	1.995	142	4	07.1996-08.1999	175A4.000		EPBMPN3-A043Z	92940	20	250

DELTA III (844_)

1.4	1.368	88	4	09.2008-08.2014	198A4.000		EPBBPT4-V010Z	91257	20	250
1.4	1.368	88	4	09.2008-08.2014	198A4.000		EPBMBN3-V001Z	92099	20	256
1.4 Bifuel	1.368	88	4	07.2011-08.2014	198A4.000		EPBBPT4-V010Z	91257	20	250
1.4 Bifuel	1.368	88	4	07.2011-08.2014	198A4.000		EPBMBN3-V001Z	92099	20	256
1.4 16V	1.368	103	4	07.2010-08.2014	198A7.000		EPBBPT4-V001Z	92565	11	307
1.4	1.368	110	4	09.2008-08.2014	198A1.000		EPBBPT4-V010Z	91257	20	250
1.4	1.368	110	4	09.2008-08.2014	198A1.000		EPBMBN3-V001Z	92099	20	256
1.6 D Multijet	1.598	88	4	09.2008-08.2014	198A2.000		EPBBPT4-V001Z	92565	11	307
1.8	1.742	147	4	01.2009-08.2014	939B1.000		EPBBPN3-V007Z	97073	20	300
2.0 D Multijet	1.956	121	4	09.2008-08.2014	198A5.000, 198A8.000		EPBBPT4-V001Z	92565	11	307

KAPPA (838_)

2.4 JTD	2.387	100	5	06.1998-10.2001	838A8.000		EPBBPN3-V034Z	96381	20	250
---------	-------	-----	---	-----------------	-----------	--	---------------	-------	----	-----



MAP

 kW
C
Y
I

Type-N°

Stock-N°

 kPa from
kPa to

LANCIA
LYBRA (839_)

1.6 16V	1.581	76	4	07.1999-10.2005	182A4.000		EPBMPT4-V012Z	91940	20	100
1.6	1.596	76	4	10.2000-10.2005	182B6.000		EPBMPT4-V012Z	91940	20	100
1.9 JTD	1.910	77	4	07.1999-09.2001	AR32302	; Engine No. <2705194	EPBBPN3-V034Z	96381	20	250
1.9 JTD	1.910	77	4	07.1999-09.2001	AR32302		EPBMBN3-V001Z	92099	20	256
1.9 JTD	1.910	81	4	09.2000-05.2001	AR37101	; Engine No. <2705194	EPBBPN3-V034Z	96381	20	250
1.9 JTD	1.910	81	4	09.2000-05.2001	AR37101		EPBMBN3-V001Z	92099	20	256
1.9 JTD	1.910	85	4	05.2001-10.2005	937A2.000	; Engine No. <2705194	EPBBPN3-V034Z	96381	20	250
1.9 JTD	1.910	85	4	05.2001-10.2005	937A2.000		EPBMBN3-V001Z	92099	20	256
2.4 JTD	2.387	99	5	07.1999-02.2001	839A5.000, AR32501		EPBBPN3-V034Z	96381	20	250
2.4 JTD	2.387	103	5	09.2000-10.2005	839A6.000		EPBMBN3-V001Z	92099	20	256
2.4 JTD	2.387	110	5	05.2002-10.2005	841C.000		EPBMBN3-V001Z	92099	20	256

MUSA (350_)

1.3 D Multijet	1.248	51	4	10.2004-09.2012	188A9.000	; Position: Intake Manifold	EPBMBN3-V001Z	92099	20	256
1.3 D Multijet	1.248	66	4	09.2006-09.2012	199A3.000		EPBBPT4-V001Z	92565	11	307
1.3 D Multijet	1.248	70	4	03.2009-09.2012	199B1.000		EPBBPT4-V001Z	92565	11	307
1.4	1.368	57	4	09.2005-09.2012	350A1.000	;	EPBMPN3-V022Z	91412	10	117
1.4	1.368	57	4	09.2005-09.2012	350A1.000		EPBMPT4-V003Z	93266	10	118
1.4 LPG	1.368	57	4	11.2010-09.2012	350A1.000	;	EPBMPN3-V022Z	91412	10	117
1.4 LPG	1.368	57	4	11.2010-09.2012	350A1.000		EPBMPT4-V003Z	93266	10	118
1.4	1.368	66	4	10.2007-09.2012	192B2.000		EPBMPT4-V003Z	93266	10	118
1.4	1.368	70	4	10.2004-09.2012	843A1.000		EPBMPT4-V003Z	93266	10	118
1.6 D Multijet	1.598	85	4	07.2008-09.2012	350A2.000, 350A3.000		EPBBPT4-V001Z	92565	11	307
1.6 D Multijet	1.598	88	4	07.2008-09.2012	350A2.000		EPBBPT4-V001Z	92565	11	307
1.9 D Multijet	1.910	74	4	10.2004-09.2012	188B2.000		EPBBPT4-V001Z	92565	11	307

PHEDRA (179_)

2.0 JTD	1.997	80	4	09.2002-11.2010	RHW(DW10ATED4)		EPBBPN3-A003Z	91268	10	250
2.0 JTD	1.997	88	4	06.2006-11.2010	RHK(DW10UTED4)		EPBBPN3-A001Z	94263	10	240
2.0 D Multijet	1.997	100	4	07.2006-11.2010	RHR(DW10BTED4)		EPBBPN3-A001Z	94263	10	240
2.0	1.997	100	4	09.2002-11.2010	RFN(EW10J4)		EPBMPN3-A020Z	96725	20	117
2.2 JTD	2.179	94	4	-06.2003	4HW(DW12ATED4)		EPBBPN3-A003Z	91268	10	250
2.2 JTD	2.179	94	4	06.2003	4HW(DW12ATED4)		EPBBPN3-A006Z	91736	10	240
2.2 JTD	2.179	120	4	04.2006-11.2010	4HP, 4HR		EPBBPN3-A006Z	91736	10	240
2.2 D Multijet	2.179	125	4	03.2008-11.2010	4HT, 4HS		EPBBPN3-A017Z	95311	35	320
2.2 D Multijet	2.179	125	4	03.2008-11.2010	4HT, 4HS		EPBBPN3-A018Z	95753	35	320
3.0 V6	2.946	150	6	09.2002-11.2010	ES9J4S		EPBMPN3-A020Z	96725	20	117

THESIS (841_)

2.0 Turbo	1.998	136	5	07.2002-07.2009	841E.000	; 4; Number of Poles: 4	EPBBPT4-V010Z	91257	20	250
-----------	-------	-----	---	-----------------	----------	--------------------------	---------------	-------	----	-----



MAP



l kW
C
Y
I



Type-N°

Stock-N°

kPa from

kPa to

LANCIA

THESIS (841_)

2.0 Turbo	1.998	136	5	07.2002-07.2009	841E.000	; Number of Poles: 3	EPBMPN3-V022Z	91412	10	117
2.4 JTD	2.387	110	5	07.2002-07.2009	841C.000		EPBMBN3-V001Z	92099	20	256
2.4 JTD	2.387	129	5	05.2003-07.2009	841G.000		EPBBPT4-V001Z	92565	11	307
2.4 D Multijet	2.387	136	5	04.2006-07.2009	841P.000		EPBBPT4-V001Z	92565	11	307

Y (840_)

1.1	1.108	40	4	11.1995-09.2003	176B2.000		EPBMPN3-A002Z	96249	15	100
1.2	1.242	44	4	03.1996-09.2003	188A4.000, 840A3.000		EPBMPN3-A002Z	96249	15	100
1.2	1.242	44	4	01.2000-	188A4.000, 840A3.000		EPBMPT4-V012Z	91940	20	100
1.2 16V	1.242	63	4	04.1997-09.2003	176B9.000		EPBMPT4-V012Z	91940	20	100

YPSILON (312_)

0.9 TwinAir	875	63	2	05.2011-	312A2.000		EPBBPT4-V001Z	92565	11	307
0.9 TwinAir	875	63	2	05.2011-	312A2.000		EPBBPN3-V007Z	97073	20	300
1.2 Bi-fuel	1.242	49	4	02.2012-	169A4.000		EPBMPT4-V003Z	93266	10	118
1.2 Bi-fuel	1.242	51	4	02.2012-	169A4.000		EPBMPT4-V003Z	93266	10	118
1.2	1.242	51	4	06.2011-	169A4.000		EPBMPT4-V003Z	93266	10	118
1.3 D Multijet	1.248	70	4	05.2011-	199B1.000, 312B1.000		EPBBPT4-V001Z	92565	11	307

YPSILON (843_)

1.2	1.242	44	4	10.2003-12.2011	188A4.000		EPBMPT4-V003Z	93266	10	118
1.3 JTD	1.248	51	4	10.2003-12.2011	188A9.000		EPBMBN3-V001Z	92099	20	256
1.3 D Multijet	1.248	55	4	09.2006-12.2011	199A2.000		EPBMBN3-V001Z	92099	20	256
1.3 D Multijet	1.248	66	4	09.2006-12.2011	199A3.000		EPBMBN3-V001Z	92099	20	256
1.3 D Multijet	1.248	66	4	09.2006-12.2011	199A3.000		EPBBPT4-V001Z	92565	11	307
1.3 D Multijet	1.248	77	4	05.2007-12.2011	199A3.000		EPBMBN3-V001Z	92099	20	256
1.3 D Multijet	1.248	77	4	05.2007-12.2011	199A3.000		EPBBPT4-V001Z	92565	11	307
1.4	1.368	57	4	02.2006-12.2011	350A1.000	; Position: Upper	EPBMPN3-V022Z	91412	10	117
1.4	1.368	57	4	02.2006-12.2011	350A1.000		EPBMPT4-V003Z	93266	10	118
1.4 LPG	1.368	57	4	11.2010-12.2011	350A1.000	; Position: Upper	EPBMPN3-V022Z	91412	10	117

ZETA (22_)

2.0 16V	1.998	97	4	05.1998-07.2000	RFV(XU10J4R)	; VET >8057	EPBMPN3-A007Z	96754	20	105
2.0 16V	1.998	97	4	05.1998-07.2000	RFV(XU10J4R)	; VET <8057	EPBMPN3-A009Z	92952	20	100
2.0 16V	1.997	100	4	07.2000-09.2002	RFN		EPBMPN3-A007Z	96754	20	105
2.1 TD	2.088	80	4	05.1996-09.1999	P8C		EPBBPN3-A027Z	92471	10	200

LAND ROVER

DEFENDER (L316)

2.2 Td4 4x4	2.198	90	4	08.2011-02.2016	DT224	; Chass. >CA000001	EPBMPN3-V019Z	93061	10	307,5
2.2 Td4 4x4	2.198	110	4	02.2015-02.2016	DT224	; Chass. >CA000001	EPBMPN3-V019Z	93061	10	307,5
2.5 Td5 4x4	2.495	90	5	06.1998-02.2016	10P, 14P, 15P		EPBBPT4-V012Z	96542	20	250



MAP



l kW
C
Y
I



Type-N°

Stock-N°

kPa from

kPa to

LAND ROVER

DISCOVERY II (L318)

2.5 Td5 4x4	2.495	102	5	11.1998-06.2004	10P, 15P		EPBBPT4-V012Z	96542	20	250
-------------	-------	-----	---	-----------------	----------	--	---------------	-------	----	-----

DISCOVERY IV (L319)

3.0 TD 4x4	2.993	155	6	05.2010-	306DT		EPBMPN3-A051Z	92149		
3.0 TD 4x4	2.993	180	6	09.2009-	306DT		EPBMPN3-A051Z	92149		
3.0 TD 4x4	2.993	183	6	07.2012-	306DT		EPBMPN3-A051Z	92149		
3.0 SDV6 4x4	2.993	188	6	11.2009-	306DT		EPBMPN3-A051Z	92149		

DISCOVERY SPORT (L550)

2.0 4x4	1.999	177	4	11.2014-	204PT		EPBMPN3-V019Z	93061	10	307,5
2.2 D 4x4	2.179	110	4	09.2014-	224DT		EPBBPN3-A018Z	95753	35	320
2.2 D 4x4	2.179	140	4	09.2014-	224DT		EPBBPN3-A018Z	95753	35	320

FREELANDER (L314)

1.8 16V 4x4	1.796	86	4	04.1998-10.2006	18K4F		EPBMPT4-V009Z	96309	10	117
1.8 i 16V 4x4	1.796	88	4	02.1998-10.2006	18K4F		EPBMPT4-V009Z	96309	10	117
2.0 Td4 4x4	1.951	80	4	03.2001-10.2006	204D3		EPBBPN3-A005Z	90934	30	240
2.0 Td4 4x4	1.951	82	4	11.2000-10.2006	204D3		EPBBPN3-A005Z	90934	30	240
2.0 Td4 4x4	1.951	82	4	11.2000-10.2006	M47		EPBBPN3-A005Z	90934	30	240
2.0 DI 4x4	1.994	72	4	02.1998-10.2006	20T2N		EPBBPN3-A028Z	93277	20	200
2.5 V6 4x4	2.497	130	6	11.2000-10.2006	25K4F		EPBBPN3-A005Z	90934	30	240

FREELANDER 2 (L359)

2.0 Si4 4x4	1.999	177	4	10.2011-10.2014	204PT		EPBMPN3-V019Z	93061	10	307,5
2.0 Si4 4x4	1.999	177	4	10.2011-10.2014	204PT		EPBBPT4-V009Z	95675	20	300
2.2 eD4	2.179	110	4	08.2010-10.2014	DW12BTED4	; Position: Intake Manifold	EPBBPN3-A018Z	95753	35	320
2.2 eD4	2.179	110	4	08.2010-10.2014	224DT, DW12BTED4		EPBBPT4-V009Z	95675	20	300
2.2 TD4 4x4	2.179	110	4	10.2006-10.2014	224DT, DW12BTED4		EPBBPT4-V009Z	95675	20	300
2.2 TD4 4x4	2.179	110	4	10.2006-10.2014	224DT, DW12BTED4	; Position: Intake Manifold	EPBBPN3-A018Z	95753	35	320
2.2 TD4 4x4	2.179	112	4	01.2007-10.2014	224DT	; Position: Intake Manifold	EPBBPN3-A018Z	95753	35	320
2.2 TD4 4x4	2.179	112	4	01.2007-10.2014	224DT		EPBBPT4-V009Z	95675	20	300
2.2 TD4 4x4	2.179	115	4	10.2006-10.2014	224DT	; Position: Intake Manifold	EPBBPN3-A018Z	95753	35	320
2.2 TD4 4x4	2.179	118	4	10.2006-10.2014	224DT, DW12BTED4		EPBBPT4-V009Z	95675	20	300
2.2 TD4 4x4	2.179	118	4	10.2006-10.2014	224DT, DW12BTED4	; Position: Intake Manifold	EPBBPN3-A018Z	95753	35	320
2.2 SD4 4x4	2.179	140	4	08.2010-10.2014	224DT	; Position: Intake Manifold	EPBBPN3-A018Z	95753	35	320
2.2 SD4 4x4	2.179	140	4	08.2010-10.2014	224DT		EPBBPT4-V009Z	95675	20	300





RANGE ROVER EVOQUE (L538)

2.0 4x4	1.999	176	4	09.2011-	204PT		EPBMPN3-V019Z	93061	10	307,5
2.0 4x4	1.999	177	4	06.2011-	204PT		EPBMPN3-V019Z	93061	10	307,5
2.0 4x4	1.999	177	4	06.2011-	204PT		EPBBPT4-V009Z	95675	20	300
2.2 D	2.179	110	4	06.2011-	224DT		EPBBPN3-A018Z	95753	35	320
2.2 D	2.179	110	4	06.2011-	224DT		EPBBPT4-V009Z	95675	20	300



LAND ROVER



RANGE ROVER EVOQUE (L538)

2.2 D 4x4	2.179	110	4	06.2011-	224DT		EPBBPN3-A018Z	95753	35	320
2.2 D 4x4	2.179	110	4	06.2011-	224DT		EPBBPT4-V009Z	95675	20	300
2.2 D 4x4	2.179	140	4	06.2011-	224DT		EPBBPN3-A018Z	95753	35	320
2.2 D 4x4	2.179	140	4	06.2011-	224DT		EPBBPT4-V009Z	95675	20	300









RANGE ROVER II (P38A)

2.5 D 4x4	2.497	100	6	07.1994-03.2002	256T(BMW)		EPBBPN3-A013Z	95023	30	245
-----------	-------	-----	---	-----------------	-----------	---	---------------	-------	----	-----





RANGE ROVER III (L322)

3.0 D 4x4	2.926	130	6	03.2002-08.2012	306D1		EPBBPN3-A005Z	90934	30	240
4.2 4x4	4.197	291	8	05.2005-08.2012	428PS	 ; For mechanically actuated throttle	EPBMPT4-A007Z	96755	10	120
5.0 4x4	4.999	375	8	09.2009-08.2012	508PS		EPBBPT4-V009Z	95675	20	300







RANGE ROVER IV (L405)

3.0 TDV6 4x4	2.993	155	6	10.2013-	306DT		EPBMPN3-A051Z	92149		
3.0 SDV6 4x4	2.993	183	6	08.2012-	306DT		EPBMPN3-A051Z	92149		
3.0 TDV6 4x4	2.993	190	6	08.2012-	306DT		EPBMPN3-A051Z	92149		
3.0 SDV6 Hybrid 4x4	2.993	250	6	10.2013-	306DT		EPBMPN3-A051Z	92149		
3.0 SCV6 4x4	2.995	250	6	10.2013-	306PS		EPBBPT4-V009Z	95675	20	300
3.0 SCV6 4x4	2.995	280	6	06.2015-	306PS		EPBBPT4-V009Z	95675	20	300
5.0 SCV8 4x4	5.000	375	8	08.2012-	508PS		EPBBPT4-V009Z	95675	20	300
5.0 SCV8 4x4	5.000	405	8	06.2015-	508PS		EPBBPT4-V009Z	95675	20	300

RANGE ROVER SPORT (L320)

3.0 D 4x4	2.993	183	6	08.2012-03.2013	306DT		EPBMPN3-A051Z	92149		
4.2 4x4	4.197	287	8	02.2005-03.2013	428PS		EPBMPT4-A007Z	96755	10	120
5.0 4x4	4.999	372	8	04.2009-03.2013	508PS		EPBBPT4-V009Z	95675	20	300
5.0 4x4	4.999	375	8	09.2009-03.2013	508PS		EPBBPT4-V009Z	95675	20	300

RANGE ROVER SPORT (L494)

3.0 SDV6 4x4	2.993	215	6	04.2013-	306DT		EPBMPN3-A051Z	92149		
3.0 SDV6 4x4	2.993	225	6	09.2014-	306DT		EPBMPN3-A051Z	92149		
3.0 SDV6 Hybrid 4x4	2.993	250	6	10.2013-	306DT		EPBMPN3-A051Z	92149		
3.0 SCV6 4x4	2.995	250	6	04.2013-	306PS		EPBBPT4-V009Z	95675	20	300
5.0 SCV8 4x4	4.999	375	8	04.2013-	508PS		EPBBPT4-V009Z	95675	20	300
5.0 SCV8 4x4	4.999	405	8	01.2014-	508PS		EPBBPT4-V009Z	95675	20	300

LDV

MAXUS

2.5 D	2.499	70	4	02.2005-12.2008	VM39C, VM40C, VMR425		EPBBPT4-V001Z	92565	11	307
2.5 D	2.499	88	4	02.2005-12.2009	VM39C		EPBBPT4-V001Z	92565	11	307

LEXUS

ES (_V6_)

200	1.998	110	4	08.2015-06.2018	6AR-FSE		EPBMPN3-V025Z	94855	10	138,7
-----	-------	-----	---	-----------------	---------	---	---------------	-------	----	-------

MAP



l kW
C
Y
I



Type-N°

Stock-N°

kPa from
kPa to

LEXUS

ES (_V6_)

300h	2.494	118	4	06.2012-06.2018	2AR-FXE		EPBMPN3-V025Z	94855	10	138,7
------	-------	-----	---	-----------------	---------	--	---------------	-------	----	-------

ES (_Z10_, _A10_, _H10_)

200	1.998	110	4	10.2018-	6AR-FSE		EPBMPN3-V025Z	94855	10	138,7
-----	-------	-----	---	----------	---------	--	---------------	-------	----	-------

GS (_L1_)

300h	2.494	133	4	10.2013-	2AR-FSE		EPBMPN4-A023Z	91984	11,2	307,2
450h	3.456	213	6	07.2012-	2GR-FXE		EPBMPT4-A030Z	96501	10	130
450h	3.456	215	6	01.2012-	2GR-FXE		EPBMPT4-A030Z	96501	10	130

GX (URJ15_, GRJ15_)

460 4WD	4.608	218	8	-08.2010	1UR-FE		EPBMPT4-A030Z	96501	10	130
460 4WD	4.608	218	8	09.2010-	1UR-FE		EPBMPN4-A023Z	91984	11,2	307,2
460 4WD	4.608	225	8	-08.2010	1UR-FE		EPBMPT4-A030Z	96501	10	130
460 4WD	4.608	225	8	09.2010-	1UR-FE		EPBMPN4-A023Z	91984	11,2	307,2

IS II (_E2_)

200d	2.231	110	4	07.2010-07.2012	2AD-FTV		EPBMBN3-V005Z	90946	27,8	400
220d	2.231	130	4	08.2005-07.2012	2AD-FHV		EPBMBN3-V005Z	90946	27,8	400

IS III (_E3_)

300h	2.494	131	4	04.2013-	2AR-FSE		EPBMPN4-A023Z	91984	11,2	307,2
------	-------	-----	---	----------	---------	--	---------------	-------	------	-------

LC (_Z10_)

500h	3.456	220	6	11.2016-	8GR-FXS		EPBMPN4-A023Z	91984	11,2	307,2
------	-------	-----	---	----------	---------	--	---------------	-------	------	-------

LS (_F5_)

500h	3.456	220	6	10.2017-	8GR-FXS		EPBMPN4-A023Z	91984	11,2	307,2
500h AWD	3.456	220	6	10.2017-	8GR-FXS		EPBMPN4-A023Z	91984	11,2	307,2
500h	3.456	264	6	11.2017-	8GR-FXS		EPBMPN4-A023Z	91984	11,2	307,2

NX (_Z1_)

200	1.987	110	4	11.2014-	3ZR-FAE		EPBMPN3-V025Z	94855	10	138,7
200 AWD	1.987	110	4	11.2014-	3ZR-FAE		EPBMPN3-V025Z	94855	10	138,7
300h	2.494	114	4	07.2014-	2AR-FXE		EPBMPN3-V025Z	94855	10	138,7
300h AWD	2.494	114	4	07.2014-	2AR-FXE		EPBMPN3-V025Z	94855	10	138,7

RC (_C1_)

300h	2.494	133	4	09.2014-	2AR-FSE		EPBMPN4-A023Z	91984	11,2	307,2
------	-------	-----	---	----------	---------	--	---------------	-------	------	-------

RX (_L1_)

450h	3.456	183	6	12.2008-10.2015	2GR-FXE		EPBMPT4-A030Z	96501	10	130
450h AWD	3.456	183	6	12.2008-10.2015	2GR-FXE		EPBMPT4-A030Z	96501	10	130

RX (_L2_)

450h	3.456	193	6	10.2015-	2GR-FXS		EPBMPN4-A023Z	91984	11,2	307,2
450h AWD	3.456	193	6	11.2015-	2GR-FXS		EPBMPN4-A023Z	91984	11,2	307,2
450h AWD	3.456	230	6	11.2015-	2GR-FXS		EPBMPN4-A023Z	91984	11,2	307,2

MAZDA

2 (DE_, DH_)

1.3 BiFuel	1.349	55	4	05.2011-11.2014	ZJ-46		EPBMPN3-V032Z	94413	10	213,5
------------	-------	----	---	-----------------	-------	--	---------------	-------	----	-------



MAP



l kW
C
Y
I



Type-N°

Stock-N°

kPa from

kPa to

MAZDA

2 (DE_, DH_)

1.3 MZR	1.349	62	4	01.2010-06.2015	ZJ-VE	; Position: Intake Manifold	EPBMPN3-V032Z	94413	10	213,5
1.3 BiFuel	1.349	62	4	05.2011-11.2014	ZJ-46		EPBMPN3-V032Z	94413	10	213,5
1.3	1.349	63	4	10.2007-06.2015	ZJ-VE	; Position: Intake Manifold	EPBMPN3-V032Z	94413	10	213,5
1.4 MZR-CD	1.399	50	4	01.2008-06.2015	Y404		EPBBPN3-A006Z	91736	10	240
1.5 MZR	1.498	75	4	06.2011-06.2015	ZY05	; Position: Intake Manifold	EPBMPN3-V032Z	94413	10	213,5
1.5 MZR	1.498	75	4	06.2011-06.2015	ZY66		EPBMPN3-V032Z	94413	10	213,5
1.5	1.498	76	4	10.2007-06.2015	ZY-VE, ZY-DE	; Position: Intake Manifold	EPBMPN3-V032Z	94413	10	213,5

2 (DY) | DEMIO

1.25	1.242	55	4	04.2003-06.2007	FUJA		EPBMPT4-A007Z	96755	10	120
1.3 L	1.348	67	4	04.2003-06.2007	ZJ-04		EPBMPT4-A007Z	96755	10	120
1.2	1.242	55	4	02.2003-06.2007	FUJA		EPBMPT4-A007Z	96755	10	120
1.4	1.388	59	4	02.2003-06.2007	FXJA		EPBMPT4-A007Z	96755	10	120
1.6	1.596	74	4	02.2003-06.2007	FYJA		EPBMPT4-A007Z	96755	10	120

3 (BK)

1.3	1.349	62	4	10.2003-06.2009	ZJ-VE, ZJ07, ZJ32		EPBMPN3-A016Z	96896	10	115
1.6 MZ-CD	1.560	66	4	06.2006-12.2009	Y406	; Position: Intake Manifold	EPBBPN3-A001Z	94263	10	240
1.6	1.598	77	4	10.2003-06.2009	B6ZE, Z601, Z627		EPBMPN3-A016Z	96896	10	115
1.6 DI Turbo	1.560	80	4	06.2004-06.2009	Y601	; Position: Intake Manifold	EPBBPN3-A001Z	94263	10	240
2.0	1.999	104	4	10.2003-06.2006	LF17	; Position: Intake Manifold	EPBMPN4-A035Z	96317	10	115
2.0 MZR-CD	1.998	105	4	07.2006-06.2009	RF7J	; Position: Intake Manifold	EPBMPN3-V024Z	93159	26,9	400
2.0	1.999	110	4	10.2003-12.2009	LF50, LF72, LFDE, LFN7, LFN8, LFVE		EPBMPN3-A016Z	96896	10	115
2.0	1.999	110	4	10.2003-12.2009	LF50, LF72, LFN7, LFN8		EPBMPN4-A035Z	96317	10	115

3 (BL)

1.6 MZR	1.598	77	4	12.2008-09.2014	Z6	; Position: Intake Manifold	EPBMPN3-V032Z	94413	10	213,5
1.6 MZR	1.598	79	4	01.2010-12.2013	Z6	; Position: Intake Manifold	EPBMPN3-V032Z	94413	10	213,5
1.6 MZ-CD	1.560	80	4	12.2008-05.2013	Y601, Y642	; Position: Intake Manifold; Number of Gears: 5 Speed	EPBBPN3-A001Z	94263	10	240
1.6 MZ-CD	1.560	80	4	12.2008-05.2013	Y601		EPBMBT4-A003Z	93024	12,9	316,5
2.0 MZR	1.999	108	4	04.2009-09.2014	LF-5H	; Position: Intake Manifold	EPBMPN4-A035Z	96317	10	115
2.0 MZR	1.999	110	4	01.2009-09.2014	LF17, LF-DE	; Position: Intake Manifold	EPBMPN4-A035Z	96317	10	115
2.2 MZR CD	2.184	110	4	01.2009-09.2014	R2AA	; Position: Intake Manifold	EPBMPN3-V024Z	93159	26,9	400
2.2 MZR CD	2.184	136	4	01.2009-05.2013	R2AA	; Position: Intake Manifold	EPBMPN3-V024Z	93159	26,9	400
2.5	2.488	122	4	03.2009-09.2014	L5-VE		EPBMPN4-A035Z	96317	10	115

323 S VI (BJ)

1.3	1.324	53	4	01.2001-05.2004	B3 (16V)		EPBMPN3-A016Z	96896	10	115
1.6	1.598	70	4	01.2001-05.2004	ZM		EPBMPN3-A016Z	96896	10	115
1.6	1.598	72	4	01.2001-05.2004	ZM		EPBMPN3-A016Z	96896	10	115
2.0	1.991	96	4	01.2001-05.2004	FS7E, FS7G		EPBMPN3-A016Z	96896	10	115



MAP



l kW
C
Y
I



Type-N°

Stock-N°

kPa from
kPa to

MAZDA

5 (CR19)

1.8	1.798	85	4	02.2005-05.2010	L823	; Position: Intake Manifold	EPBMPN4-A035Z	96317	10	115
2.0 CD	1.998	81	4	02.2005-05.2010	RF7J	; Position: Intake Manifold	EPBMPN3-V024Z	93159	26,9	400
2.0 CD	1.998	105	4	02.2005-05.2010	RF7J		EPBMPN3-V024Z	93159	26,9	400
2.0	1.999	107	4	02.2005-05.2010	LFF7	; Position: Intake Manifold	EPBMPN4-A035Z	96317	10	115

5 (CW)

1.6 CD	1.560	85	4	09.2010-	Y655		EPBMBT4-A003Z	93024	12,9	316,5
1.8 MZR	1.798	85	4	09.2010-	L850		EPBMPN4-A035Z	96317	10	115
2.0	1.999	106	4	06.2010-	LF-ZB		EPBMPN4-A035Z	96317	10	115
2.0	1.999	108	4	01.2011-	LF-ZB	; Position: Intake Manifold	EPBMPN4-A035Z	96317	10	115
2.0	1.999	110	4	09.2010-	LF-5H, LF-ZB		EPBMPN4-A035Z	96317	10	115

6 (GG)

1.8	1.798	88	4	08.2002-08.2007	L813, L823, L828, L829		EPBMPN3-A016Z	96896	10	115
1.8	1.798	88	4	08.2002-08.2007	L813, L823, L828	; Position: Intake Manifold	EPBMPN4-A035Z	96317	10	115
2.0 DI	1.998	89	4	08.2002-08.2007	RF5C		EPBMPN3-A016Z	96896	10	115
2.0 DI	1.998	100	4	08.2002-08.2007	RF5C		EPBMPN3-A016Z	96896	10	115
2.0	1.999	104	4	08.2002-08.2007	LF17, LF18		EPBMPN3-A016Z	96896	10	115
2.0	1.999	104	4	08.2002-08.2007	LF17, LF18	; Position: Intake Manifold	EPBMPN4-A035Z	96317	10	115
2.0	1.999	108	4	03.2005-08.2007	LFF7	; Position: Intake Manifold	EPBMPN4-A035Z	96317	10	115
2.3	2.261	120	4	03.2005-07.2007	L3C1	; Position: Intake Manifold	EPBMPN4-A035Z	96317	10	115
2.3	2.261	122	4	08.2002-08.2007	L3C1	; Position: Intake Manifold	EPBMPN4-A035Z	96317	10	115
2.3	2.261	122	4	08.2002-08.2007	L3C1		EPBMPN3-A016Z	96896	10	115
2.3 MPS Turbo	2.261	191	4	12.2005-08.2007	L3KG	; Position: Intake Manifold	EPBMPN4-A035Z	96317	10	115

6 (GH)

1.8 MZR	1.798	88	4	08.2007-07.2013	L813	; Position: Intake Manifold	EPBMPN4-A035Z	96317	10	115
2.0 MZR	1.999	108	4	08.2007-07.2013	LF17		EPBMPN4-A035Z	96317	10	115
2.0 MZR	1.999	114	4	01.2010-07.2013	LF-DE		EPBMPN4-A035Z	96317	10	115
2.5 MZR	2.488	125	4	08.2007-07.2013	L5-VE		EPBMPN4-A035Z	96317	10	115

6 STATION WAGON (GY)

1.8	1.798	88	4	08.2002-08.2007	L813	; Position: Intake Manifold	EPBMPN4-A035Z	96317	10	115
1.8	1.798	88	4	08.2002-08.2007	L813		EPBMPN3-A016Z	96896	10	115
2.0 DI	1.998	89	4	08.2002-08.2007	RF5C		EPBMPN3-A016Z	96896	10	115
2.0 DI	1.998	100	4	08.2002-02.2005	RF5C		EPBMPN3-A016Z	96896	10	115
2.0	1.999	104	4	08.2002-08.2007	LF17, LF18		EPBMPN3-A016Z	96896	10	115
2.0	1.999	104	4	08.2002-08.2007	LF17, LF18	; Position: Intake Manifold	EPBMPN4-A035Z	96317	10	115
2.0	1.999	108	4	03.2005-08.2007	LFF7	; Position: Intake Manifold	EPBMPN4-A035Z	96317	10	115
2.3 AWD	2.261	119	4	11.2002-08.2007	L3C1	; Position: Intake Manifold	EPBMPN4-A035Z	96317	10	115
2.3 AWD	2.261	119	4	11.2002-08.2007	L3C1		EPBMPN3-A016Z	96896	10	115



MAP



l kW C
Y I



Type-N°

Stock-N°

kPa from

kPa to

MAZDA

6 STATION WAGON (GY)

2.3	2.261	122	4	01.2002-02.2008	L3C1	; Position: Intake Manifold	EPBMPN4-A035Z	96317	10	115
2.3	2.261	122	4	01.2002-02.2008	L3C1		EPBMPN3-A016Z	96896	10	115

626 V (GF, GW)

1.8	1.840	74	4	12.1999-10.2002	FP9A		EPBMPN3-A016Z	96896	10	115
2.0 DITD	1.998	66	4	09.1999-10.2002	RF3F		EPBMPN3-A016Z	96896	10	115

BT-50 PICKUP (CD, UN)

2.5 MRZ-CD 4x4	2.499	105	4	12.2006-12.2015	WLAA		EPBBPT4-V001Z	92565	11	307
----------------	-------	-----	---	-----------------	------	--	---------------	-------	----	-----

CX-7 (ER)

2.5 MZR	2.488	120	4	07.2009-03.2013	L5-VE		EPBMPN4-A035Z	96317	10	115
---------	-------	-----	---	-----------------	-------	--	---------------	-------	----	-----

DEMIO (DW)

1.5 16V	1.498	55	4	04.2000-07.2003	B5E		EPBMPN3-A016Z	96896	10	115
---------	-------	----	---	-----------------	-----	--	---------------	-------	----	-----

MPV II (LW)

2.3	2.261	104	4	07.2002-02.2006	L3	; Number of Poles: 4	EPBMPN4-A035Z	96317	10	115
-----	-------	-----	---	-----------------	----	----------------------	---------------	-------	----	-----

MX-5 III (NC)

1.8	1.798	93	4	03.2005-12.2014	L828, L8-DE	; Position: Intake Manifold	EPBMPN4-A035Z	96317	10	115
-----	-------	----	---	-----------------	-------------	-----------------------------	---------------	-------	----	-----

PREMACY (CP)

1.9	1.840	74	4	07.1999-03.2005	FP		EPBMPN3-A016Z	96896	10	115
1.9	1.840	84	4	07.1999-03.2005	FP		EPBMPN3-A016Z	96896	10	115
2.0 TD	1.998	66	4	10.1999-07.2000	RF3F		EPBMPN3-A016Z	96896	10	115
2.0	1.991	96	4	11.2001-03.2005	FS7E, FS7G		EPBMPN3-A016Z	96896	10	115

RX-8 (SE, FE)

1.3	1.308	141	2	10.2003-06.2012	13B-MSP		EPBMPN3-A016Z	96896	10	115
1.3	1.308	170	2	10.2003-06.2012	13B-MSP		EPBMPN3-A016Z	96896	10	115

TRIBUTE (EP)

2.3 GX	2.261	110	4	12.2003-10.2004	L3-VE		EPBMPN4-A035Z	96317	10	115
--------	-------	-----	---	-----------------	-------	--	---------------	-------	----	-----

XEDOS 9 (TA)

2.5 V6	2.497	120	6	07.2000-09.2002	KL		EPBMPN3-A016Z	96896	10	115
--------	-------	-----	---	-----------------	----	--	---------------	-------	----	-----

MERCEDES-BENZ

A-CLASS (W168)

A 160 CDI	1.689	44	4	07.1998-02.2001	OM668.941		EPBBPN3-A009Z	96930	50	250
A 160 CDI	1.689	44	4	07.1998-02.2001	OM668.941	; Chass. >J178472	EPBBPN3-A002Z	94523	15	260
A 160 CDI	1.689	55	4	02.2001-08.2004	OM668.940	; Chass. <J178471	EPBBPN3-A009Z	96930	50	250
A 160 CDI	1.689	55	4	02.2001-08.2004	OM668.940	; Chass. >J178472	EPBBPN3-A002Z	94523	15	260
A 170 CDI	1.689	66	4	07.1998-02.2001	OM668.940		EPBBPN3-A009Z	96930	50	250
A 170 CDI	1.689	66	4	07.1998-02.2001	OM668.940	; Chass. >J178472	EPBBPN3-A002Z	94523	15	260
A 170 CDI	1.689	70	4	02.2001-08.2004	OM668.942	; Chass. <J178471	EPBBPN3-A009Z	96930	50	250
A 170 CDI	1.689	70	4	02.2001-08.2004	OM668.942	; Chass. >J178472	EPBBPN3-A002Z	94523	15	260

A-CLASS (W169)

A 160 CDI	1.991	60	4	09.2004-06.2012	OM640.942		EPBBPN3-A011Z	91149	50	310
-----------	-------	----	---	-----------------	-----------	--	---------------	-------	----	-----



MAP



l kW
C
Y
I



Type-N°

Stock-N°

kPa from

kPa to

MERCEDES-BENZ

A-CLASS (W169)

A 180 CDI	1.991	80	4	09.2004-06.2012	OM640.940		EPBBPN3-A011Z	91149	50	310
A 200 CDI	1.991	100	4	09.2004-06.2012	OM640.941		EPBBPN3-A011Z	91149	50	310
A 200 CDI	1.991	103	4	09.2004-06.2012	OM640.941		EPBBPN3-A011Z	91149	50	310

A-CLASS (W176)

A 220 d 4-matic	2.143	130	4	07.2015-05.2018	OM651.930		EPBMBN3-V007Z	96602		
-----------------	-------	-----	---	-----------------	-----------	--	---------------	-------	--	--

B-CLASS (W245)

B 170 NGT	2.034	85	4	04.2008-11.2011	M266.960	; Position: Intake Manifold	EPBMPN3-A004Z	90833	10	120
B 180 CDI	1.991	80	4	03.2005-11.2011	OM640.940		EPBBPN3-A011Z	91149	50	310
B 180 NGT	2.034	85	4	04.2008-11.2011	M266.960	; Position: Intake Manifold	EPBMPN3-A004Z	90833	10	120
B 200 CDI	1.991	103	4	03.2005-11.2011	OM640.941		EPBBPN3-A011Z	91149	50	310

B-CLASS (W246, W242)

B 180 CDI	1.796	80	4	11.2011-08.2014	OM651.901		EPBMBN3-A003Z	90717	28,9	400
B 200 CDI	1.796	100	4	11.2011-08.2014	OM651.901		EPBMBN3-A003Z	90717	28,9	400

C-CLASS (S202, W202)

C 200 CDI	2.151	75	4	03.1998-03.2001	OM611.960	; Chass. <A809594, F894083	EPBBPN3-A009Z	96930	50	250
C 200 CDI	2.151	75	4	03.1998-03.2001	OM611.960	; Chass. >A809595, F894084	EPBBPN3-A002Z	94523	15	260
C 220 CDI	2.151	92	4	09.1997-03.2001	OM611.960	; Chass. <A809594, F894083	EPBBPN3-A009Z	96930	50	250
C 220 CDI	2.151	92	4	09.1997-03.2001	OM611.960	; Chass. >A809595, F894084	EPBBPN3-A002Z	94523	15	260
C 230 T	2.295	110	4	06.1996-06.1998	M111.974		EPBMPN3-A003Z	92477	15	102
C 230 Kompressor	2.295	142	4	10.1995-05.2000	M111.975		EPBMPN3-A038Z	94914	50	450
C 240 T	2.597	125	6	09.2000-03.2001	M112.915		EPBMPN3-A004Z	90833	10	120
C 250 Turbo-D	2.497	110	5	10.1995-03.2001	OM605.960		EPBBPN3-A009Z	96930	50	250
C 280	2.799	142	6	05.1993-05.2000	M104.941		EPBMPN3-A038Z	94914	50	450
C 280	2.799	145	6	06.1997-03.2001	M112.920		EPBMPN3-A004Z	90833	10	120
C 36 AMG	3.606	206	6	05.1994-05.2000	M104.941		EPBMPN3-A038Z	94914	50	450
C 43 AMG	4.266	225	8	01.2001-	M113.944		EPBMPN3-A004Z	90833	10	120

C-CLASS (CL203, S203, W203)

C 160 Kompressor	1.796	90	4	05.2002-05.2008	M271.921		EPBBPN3-A002Z	94523	15	260
C 180 Kompressor	1.796	105	4	05.2002-05.2008	M271.946		EPBBPN3-A002Z	94523	15	260
C 200 CDI	2.148	75	4	02.2001-08.2007	OM611.962, OM646.962	; Engine No. <30112421	EPBBPN3-A002Z	94523	15	260
C 200 CDI	2.148	85	4	09.2000-08.2007	OM611.962		EPBBPN3-A002Z	94523	15	260
C 200 CDI	2.148	90	4	03.2003-05.2008	OM646.962, OM646.963	; Engine No. <30112421	EPBBPN3-A002Z	94523	15	260
C 200 Kompressor	1.998	120	4	05.2000-06.2002	M111.955		EPBBPN3-A002Z	94523	15	260
C 200 Kompressor	1.796	120	4	05.2002-05.2008	M271.940		EPBBPN3-A002Z	94523	15	260
C 200 CGI Kompressor	1.796	125	4	03.2003-05.2008	M271.942		EPBBPN3-A002Z	94523	15	260
C 220 CDI	2.148	100	4	05.2000-02.2007	OM611.962		EPBBPN3-A002Z	94523	15	260
C 220 CDI	2.148	105	4	05.2000-08.2007	OM611.962, OM646.963		EPBBPN3-A002Z	94523	15	260
C 220 CDI	2.148	110	4	02.2003-02.2007	OM646.963	; Position: Air Filter Housing	EPBMPN3-A004Z	90833	10	120



MERCEDES-BENZ

C-CLASS (CL203, S203, W203)

C 220 CDI	2.148	110	4	02.2004-05.2008	OM646.963	; Engine No. <30112421	EPBBPN3-A002Z	94523	15	260
C 220 CDI	2.148	110	4	02.2004-05.2008	OM646.963		EPBBPN3-A011Z	91149	50	310
C 230 Kompressor	1.796	141	4	05.2002-05.2008	M271.948		EPBBPN3-A002Z	94523	15	260
C 230 Kompressor	2.295	145	4	03.2001-05.2002	M111.981		EPBBPN3-A002Z	94523	15	260
C 270 CDI	2.685	125	5	12.2000-08.2007	OM612.962		EPBBPN3-A002Z	94523	15	260
C 280	2.996	170	6	01.2005-08.2007	M272.940		EPBMPN3-A004Z	90833	10	120
C 280 4-matic	2.996	170	6	01.2005-08.2007	M272.941		EPBMPN3-A004Z	90833	10	120
C 320	3.199	160	6	05.2000-05.2008	M112.946		EPBMPN3-A004Z	90833	10	120
C 320 CDI	2.987	165	6	06.2005-08.2007	OM642.910		EPBBPN3-A011Z	91149	50	310
C 350	3.498	200	6	01.2005-08.2007	M272.960		EPBMPN3-A004Z	90833	10	120
C 350 4-matic	3.498	200	6	01.2005-08.2007	M272.970		EPBMPN3-A004Z	90833	10	120
C 30 CDI AMG	2.950	170	5	01.2003-02.2007	OM612.990	; Position: Air Filter Housing	EPBMPN3-A004Z	90833	10	120
C 30 CDI AMG	2.950	170	5	09.2002-05.2008	OM612.990	; For engines with EGR	EPBBPN3-A002Z	94523	15	260
C 32 AMG Kompressor	3.199	260	6	03.2001-08.2007	M112.961		EPBBPN3-A002Z	94523	15	260

C-CLASS (C204, S204, W204)

C 180 CDI	2.143	88	4	01.2011-01.2014	OM651.913	; Position: Air Filter Housing	EPBMPN3-A004Z	90833	10	120
C 180 CDI	2.143	88	4	01.2011-08.2014	OM651.913		EPBMBN3-A003Z	90717	28,9	400
C 180 Kompressor	1.796	115	4	01.2007-08.2014	M271.952		EPBBPN3-A002Z	94523	15	260
C 180 Kompressor	1.597	115	4	01.2008-08.2014	M271.910		EPBBPN3-A002Z	94523	15	260
C 200 CDI	2.143	100	4	01.2011-01.2014	OM651.913	; Position: Air Filter Housing	EPBMPN3-A004Z	90833	10	120
C 200 CDI	2.143	100	4	08.2010-08.2014	OM651.913		EPBMBN3-A003Z	90717	28,9	400
C 200 CDI	2.148	100	4	08.2007-12.2009	OM646.811		EPBBPN3-A011Z	91149	50	310
C 200 Kompressor	1.796	135	4	01.2007-01.2014	M271.950		EPBBPN3-A002Z	94523	15	260
C 200 Kompressor	1.796	135	4	08.2007-08.2014	M271.950		EPBMBN3-V007Z	96602		
C 200	1.796	137	4	05.2011-01.2014	M271.820	; Position: Suction Pipe; Position: Air Filter Housing	EPBMPN3-A004Z	90833	10	120
C 220 CDI	2.148	120	4	01.2007-11.2008	OM646.811	; Position: Suction Pipe	EPBMPN3-A004Z	90833	10	120
C 220 CDI	2.148	120	4	08.2007-11.2008	OM646.811		EPBBPN3-A011Z	91149	50	310
C 220 CDI	2.143	120	4	12.2008-08.2014	OM651.911		EPBMBN3-V007Z	96602		
C 220 CDI	2.143	120	4	06.2011-	OM651.911	; Position: Air Filter Housing	EPBMPN3-A004Z	90833	10	120
C 220 CDI	2.143	125	4	12.2008-01.2014	OM651.911	; Position: Air Filter Housing	EPBMPN3-A004Z	90833	10	120
C 220 CDI	2.143	125	4	12.2008-08.2014	OM651.911		EPBMBN3-A003Z	90717	28,9	400
C 220 CDI	2.148	125	4	08.2007-11.2008	OM646.811		EPBBPN3-A011Z	91149	50	310
C 250 CDI	2.143	150	4	08.2008-01.2014	OM651.911	; Position: Air Filter Housing	EPBMPN3-A004Z	90833	10	120
C 250 CDI	2.143	150	4	08.2008-01.2014	OM651.911		EPBMBN3-A003Z	90717	28,9	400
C 250 CDI 4-matic	2.143	150	4	01.2011-01.2014	OM651.912	; Position: Air Filter Housing	EPBMPN3-A004Z	90833	10	120
C 250 CDI 4-matic	2.143	150	4	04.2010-08.2014	OM651.912		EPBMBN3-A003Z	90717	28,9	400

MAP



l kW
C
Y
I



Type-N°

Stock-N°

kPa from

kPa to

MERCEDES-BENZ

C-CLASS (C204, S204, W204)

C 250 CGI	1.796	150	4	07.2009-08.2014	M271.860		EPBMBN3-V007Z	96602		
C 280	2.996	170	6	08.2007-08.2014	M272.947	; Position: Intake Manifold	EPBMPN3-A004Z	90833	10	120
C 300	2.996	170	6	08.2007-08.2014	M272.947	; Position: Intake Manifold	EPBMPN3-A004Z	90833	10	120
C 300 CDI 4-matic	2.987	170	6	01.2011-01.2014	OM642.832		EPBBPN3-A011Z	91149	50	310
C 320 CDI	2.987	165	6	08.2007-08.2014	OM642.960		EPBBPN3-A011Z	91149	50	310
C 350 CDI	2.987	165	6	07.2009-01.2014	OM642.960	; Position: Air Filter Housing	EPBMPN3-A004Z	90833	10	120
C 320 CDI 4-matic	2.987	165	6	07.2007-01.2014	OM642.961		EPBBPN3-A011Z	91149	50	310
C 320 CDI 4-matic	2.987	165	6	07.2007-01.2014	OM642.961	; Position: Air Filter Housing	EPBMPN3-A004Z	90833	10	120
C 350 CDI	2.987	170	6	10.2009-01.2014	OM642.830	; Position: Air Filter Housing	EPBMPN3-A004Z	90833	10	120
C 350 CDI	2.987	170	6	10.2009-01.2014	OM642.830		EPBBPN3-A011Z	91149	50	310
C 350 CDI 4-matic	2.987	170	6	10.2009-08.2014	OM642.832	; Position: Air Filter Housing	EPBMPN3-A004Z	90833	10	120
C 350 CDI 4-matic	2.987	170	6	10.2009-08.2014	OM642.832		EPBBPN3-A011Z	91149	50	310
C 350 CDI	2.987	195	6	06.2011-08.2014	OM642.834	; Position: Air Filter Housing	EPBMPN3-A004Z	90833	10	120
C 350 CDI	2.987	195	6	06.2011-08.2014	OM642.834		EPBBPN3-A011Z	91149	50	310
C 350	3.498	200	6	01.2007-08.2014	M272.961	; Position: Intake Manifold	EPBMPN3-A004Z	90833	10	120

C-CLASS (A205, C205, S205, W205)

C 200 d	2.143	100	4	10.2015-05.2018	OM651.921		EPBMBN3-V007Z	96602		
C 220 d	2.143	120	4	10.2015-05.2018	OM651.921		EPBMBN3-V007Z	96602		
C 220 BlueTEC / d	2.143	120	4	03.2014-05.2018	OM651.921		EPBMBN3-V007Z	96602		
C 220 d	2.143	125	4	10.2015-05.2018	OM651.921		EPBMBN3-V007Z	96602		
C 220 BlueTEC / d	2.143	125	4	02.2014-05.2018	OM651.921		EPBMBN3-V007Z	96602		
C 220 d 4-matic	2.143	125	4	04.2015-05.2018	OM651.921		EPBMBN3-V007Z	96602		
C 250 BlueTEC / d	2.143	150	4	02.2014-05.2018	OM651.921		EPBMBN3-V007Z	96602		
C 250 BlueTEC / d 4-matic	2.143	150	4	02.2014-05.2018	OM651.921		EPBMBN3-V007Z	96602		
C 250 d	2.143	150	4	10.2015-05.2018	OM651.921		EPBMBN3-V007Z	96602		
C 250 d 4-matic	2.143	150	4	04.2016-05.2018	OM651.921		EPBMBN3-V007Z	96602		
C 300 BlueTEC Hybrid / h	2.143	150	4	05.2014-05.2018	OM651.921		EPBMBN3-V007Z	96602		

CLC-CLASS (CL203)

CLC 160	1.597	95	4	02.2009-06.2011	M271.911		EPBBPN3-A002Z	94523	15	260
CLC 180 Kompressor	1.796	105	4	05.2008-06.2011	M271.946		EPBBPN3-A002Z	94523	15	260
CLC 200 CDI	2.148	90	4	05.2008-06.2011	OM646.962		EPBBPN3-A002Z	94523	15	260
CLC 200 CDI	2.148	90	4	05.2008-06.2011	OM646.962		EPBBPN3-A011Z	91149	50	310
CLC 200 Kompressor	1.796	135	4	05.2008-06.2011	M271.957		EPBBPN3-A002Z	94523	15	260
CLC 220 CDI	2.148	110	4	05.2008-06.2011	OM646.963		EPBBPN3-A002Z	94523	15	260
CLC 220 CDI	2.148	110	4	05.2008-06.2011	OM646.963		EPBBPN3-A011Z	91149	50	310

CLK (A208, C208)

200 Kompressor	1.998	120	4	06.2000-06.2002	M111.956		EPBBPN3-A002Z	94523	15	260
----------------	-------	-----	---	-----------------	----------	--	---------------	-------	----	-----



MERCEDES-BENZ
CLK (A208, C208)

230 Kompressor	2.295	145	4	06.2000-06.2002	M111.982		EPBBPN3-A002Z	94523	15	260
320	3.199	160	6	06.1997-06.2002	M112.940		EPBMPN3-A004Z	90833	10	120
430	4.266	205	8	07.1998-06.2002	M113.943		EPBMPN3-A004Z	90833	10	120

CLK (A209, C209)

CLK 200 CGI	1.796	125	4	07.2003-03.2010	M271.942		EPBBPN3-A002Z	94523	15	260
CLK 200 Kompressor	1.796	120	4	09.2002-03.2010	M271.940		EPBBPN3-A002Z	94523	15	260
CLK 200 Kompressor	1.796	135	4	10.2006-03.2010	M271.955		EPBBPN3-A002Z	94523	15	260
CLK 220 CDI	2.148	110	4	01.2005-05.2009	OM646.966	; Position: Air Filter Housing	EPBMPN3-A004Z	90833	10	120
CLK 240	2.597	125	6	06.2002-03.2010	M112.912		EPBMPN3-A004Z	90833	10	120
CLK 270 CDI	2.685	125	5	10.2002-05.2009	OM612.962, OM612.967		EPBBPN3-A002Z	94523	15	260
CLK 320	3.199	160	6	06.2002-03.2010	M112.955		EPBMPN3-A004Z	90833	10	120
CLK 320 CDI	2.987	165	6	01.2005-03.2010	OM642.910		EPBBPN3-A011Z	91149	50	310
CLK 500	4.966	225	8	06.2002-05.2009	M113.968		EPBMPN3-A004Z	90833	10	120
CLK 500	5.461	285	8	06.2006-03.2010	M273.967		EPBMPN3-A004Z	90833	10	120
CLK 55 AMG	5.439	270	8	09.2002-03.2010	M113.987		EPBMPN3-A004Z	90833	10	120

CLS (C219)

CLS 300	2.996	170	6	04.2009-12.2010	M272.943	; Position: Intake Manifold	EPBMPN3-A004Z	90833	10	120
CLS 320 CDI	2.987	155	6	05.2005-04.2009	OM642.920	; Position: Intake Manifold	EPBBPN3-A011Z	91149	50	310
CLS 320 CDI	2.987	165	6	01.2005-12.2010	OM642.920	; Position: Air Filter Housing	EPBMPN3-A004Z	90833	10	120
CLS 350 CDI	2.987	165	6	04.2009-12.2010	OM642.920	; Position: Air Filter Housing	EPBMPN3-A004Z	90833	10	120
CLS 350 CDI	2.987	165	6	04.2009-12.2010	OM642.920		EPBBPN3-A011Z	91149	50	310
CLS 55 AMG	5.439	350	8	01.2005-12.2010	M113.990		EPBBPN3-A002Z	94523	15	260

CLS / CLS SHOOTING BRAKE (C218, X218)

CLS 250 CDI / BlueTEC / d	2.143	150	4	04.2011-12.2017	OM651.924		EPBMBN3-A003Z	90717	28,9	400
CLS 350 BlueTEC / d	2.987	185	6	02.2013-12.2017	OM642.852	; Position: Air Filter Housing	EPBMPN3-A004Z	90833	10	120
CLS 350 BlueTEC / d	2.987	185	6	02.2013-12.2017	OM642.852, OM642.853		EPBBPN3-A011Z	91149	50	310
CLS 350 BlueTEC / d 4-matic	2.987	185	6	02.2013-12.2017	OM642.858	; Position: Air Filter Housing	EPBMPN3-A004Z	90833	10	120
CLS 350 BlueTEC / d 4-matic	2.987	185	6	05.2014-12.2017	OM642.854, OM642.858		EPBBPN3-A011Z	91149	50	310
CLS 350 BlueTEC / d	2.987	190	6	05.2014-12.2017	OM642.853	; Position: Air Filter Housing	EPBMPN3-A004Z	90833	10	120
CLS 350 BlueTEC / d	2.987	190	6	05.2014-12.2017	OM642.852, OM642.853		EPBBPN3-A011Z	91149	50	310
CLS 350 d 4-matic	2.987	190	6	04.2015-12.2017	OM642.854, OM642.858		EPBBPN3-A011Z	91149	50	310
CLS 350 CDI / d	2.987	195	6	01.2011-08.2014	OM642.852, OM642.853		EPBBPN3-A011Z	91149	50	310
CLS 350 CDI / d	2.987	195	6	10.2012-08.2014	OM642.853	; Position: Air Filter Housing	EPBMPN3-A004Z	90833	10	120
CLS 350 CDI / d 4-matic	2.987	195	6	09.2011-08.2014	OM642.854	; Position: Air Filter Housing	EPBMPN3-A004Z	90833	10	120
CLS 350 CDI / d 4-matic	2.987	195	6	09.2011-08.2014	OM642.854, OM642.858		EPBBPN3-A011Z	91149	50	310

E-CLASS (A124, C124, S124, W124)

E 320	3.199	162	6	06.1993-06.1997	M104.992		EPBMPN3-A038Z	94914	50	450
-------	-------	-----	---	-----------------	----------	--	---------------	-------	----	-----

MAP



l kW
C
Y
I



Type-N°

Stock-N°

kPa from

kPa to

MERCEDES-BENZ

E-CLASS (S210, W210, VF210)

E 200 CDI	2.151	75	4	06.1998-03.2002	OM611.961		EPBBPN3-A009Z	96930	50	250
E 200 CDI	2.151	75	4	06.1998-03.2002	OM611.961		EPBBPN3-A002Z	94523	15	260
E 200 CDI	2.148	85	4	07.1999-03.2002	OM611.961		EPBBPN3-A009Z	96930	50	250
E 200 CDI	2.148	85	4	07.1999-03.2002	OM611.961		EPBBPN3-A002Z	94523	15	260
E 200 Kompressor	1.998	120	4	08.2000-03.2003	M111.957		EPBBPN3-A002Z	94523	15	260
E 220 CDI	2.151	92	4	06.1998-07.1999	OM611.961		EPBBPN3-A009Z	96930	50	250
E 220 CDI	2.151	92	4	06.1998-07.1999	OM611.961		EPBBPN3-A002Z	94523	15	260
E 220 CDI	2.148	100	4	07.1999-03.2003	OM611.961		EPBBPN3-A009Z	96930	50	250
E 220 CDI	2.148	105	4	07.1999-03.2003	OM611.961		EPBBPN3-A009Z	96930	50	250
E 220 CDI	2.148	105	4	07.1999-03.2003	OM611.961		EPBBPN3-A002Z	94523	15	260
E 240	2.597	125	6	08.2000-03.2003	M112.914		EPBMPN3-A004Z	90833	10	120
E 250 d	2.497	83	5	06.1996-06.1998	OM605.912		EPBBPN3-A009Z	96930	50	250
E 250 Turbo-D	2.497	110	5	06.1997-07.1999	OM605.962		EPBBPN3-A009Z	96930	50	250
E 270 CDI	2.685	125	5	07.1999-03.2003	OM612.961		EPBBPN3-A002Z	94523	15	260
E 290 Turbo-D	2.874	95	5	03.1996-07.1999	OM602.982		EPBBPN3-A009Z	96930	50	250
E 300 Turbo-D	2.996	130	6	12.1996-07.1999	OM606.962		EPBBPN3-A009Z	96930	50	250
E 320 CDI	3.226	145	6	07.1999-03.2003	OM613.961		EPBBPN3-A002Z	94523	15	260
E 320	3.199	165	6	01.2001-	M112.941		EPBMPN3-A004Z	90833	10	120
E 320 4-matic	3.199	165	6	01.2001-	M112.941		EPBMPN3-A004Z	90833	10	120
E 420 T	4.196	205	8	06.1996-06.1997	M119.985		EPBMPN3-A038Z	94914	50	450
E 430	4.266	205	8	01.2001-	M113.940		EPBMPN3-A004Z	90833	10	120
E 430 4-matic	4.266	205	8	01.2001-	M113.940		EPBMPN3-A004Z	90833	10	120
E 55 AMG	5.439	260	8	01.2001-	M113.980		EPBMPN3-A004Z	90833	10	120

E-CLASS (S211, W211, VF211)

E 200 CDI	2.148	75	4	07.2002-12.2008	OM646.951		EPBBPN3-A002Z	94523	15	260
E 200 CDI	2.148	90	4	07.2002-12.2008	OM646.951		EPBBPN3-A002Z	94523	15	260
E 200 Kompressor	1.796	120	4	11.2002-07.2009	M271.941		EPBBPN3-A002Z	94523	15	260
E 200 NGT	1.796	120	4	03.2004-12.2008	M271.941		EPBBPN3-A002Z	94523	15	260
E 200 Kompressor	1.796	135	4	04.2006-07.2009	M271.956		EPBBPN3-A002Z	94523	15	260
E 220 CDI	2.148	100	4	03.2002-07.2009	OM646.961		EPBBPN3-A002Z	94523	15	260
E 220 CDI	2.148	110	4	03.2002-12.2008	OM646.961		EPBBPN3-A002Z	94523	15	260
E 220 CDI	2.149	120	4	03.2003-12.2008	OM646.821	; Position: Air Filter Housing	EPBMPN3-A004Z	90833	10	120
E 240 T	2.597	130	6	03.2003-07.2009	M112.913		EPBMPN3-A004Z	90833	10	120
E 240 T 4-matic	2.597	130	6	07.2003-07.2009	M112.917		EPBMPN3-A004Z	90833	10	120
E 270 CDI	2.685	120	5	03.2002-12.2008	OM647.961		EPBBPN3-A011Z	91149	50	310
E 270 CDI	2.685	130	5	-03.2004	OM647.961		EPBBPN3-A002Z	94523	15	260
E 270 CDI	2.685	130	5	04.2004-03.2005	OM647.961		EPBBPN3-A011Z	91149	50	310





Type-N°

Stock-N°

kPa from
kPa to

MERCEDES-BENZ

E-CLASS (S211, W211, VF211)

E 280 CDI	3.222	130	6	05.2004-07.2009	OM648.961	; Engine No. <30064540	EPBBPN3-A002Z	94523	15	260
E 320 CDI	3.222	150	6	11.2002-07.2009	OM648.961	; Engine No. <30064540	EPBBPN3-A002Z	94523	15	260
E 320	3.199	165	6	03.2002-12.2008	M112.949		EPBMPN3-A004Z	90833	10	120
E 320 T 4-matic	3.199	165	6	07.2003-07.2009	M112.954		EPBMPN3-A004Z	90833	10	120
E 320 CDI	2.987	165	6	03.2005-12.2008	OM642.920		EPBBPN3-A011Z	91149	50	310
E 350 CGI	3.498	215	6	05.2006-07.2009	M272.985		EPBMPN3-A004Z	90833	10	120
E 400 CDI	3.996	191	8	02.2003-12.2008	OM628.961		EPBBPN3-A002Z	94523	15	260
E 500 T	4.966	225	8	10.2003-07.2009	M113.967		EPBMPN3-A004Z	90833	10	120
E 500 T 4-matic	4.966	225	8	10.2003-07.2009	M113.969		EPBMPN3-A004Z	90833	10	120
E 55 AMG Kompressor	5.439	350	8	10.2002-07.2009	M113.990		EPBBPN3-A002Z	94523	15	260
E 63 AMG	6.208	378	8	03.2006-07.2009	M156.983		EPBMPN3-A004Z	90833	10	120

E-CLASS (S212, W212)

E 200 CDI / BlueTEC	2.143	100	4	01.2009-12.2016	OM651.925		EPBMBN3-A003Z	90717	28,9	400
E 200 NGT	1.796	120	4	03.2011-12.2015	M271.958		EPBBPN3-A002Z	94523	15	260
E 200 CGI	1.796	135	4	08.2009-12.2016	M271.820, M271.860		EPBMBN3-V007Z	96602		
E 220 CDI	2.143	120	4	08.2009-08.2014	OM651.924	; Position: Air Filter Housing	EPBMPN3-A004Z	90833	10	120
E 220 BlueTEC 4-matic	2.143	125	4	12.2014-12.2016	OM651.924		EPBMBN3-V007Z	96602		
E 220 CDI / BlueTEC	2.143	125	4	01.2009-12.2016	OM651.924		EPBMBN3-A003Z	90717	28,9	400
E 220 BlueTEC	2.143	130	4	05.2015-12.2016	OM651.924		EPBMBN3-V007Z	96602		
E 250 CDI / BlueTEC	2.143	150	4	01.2009-12.2016	OM651.924		EPBMBN3-A003Z	90717	28,9	400
E 250 CDI / BlueTEC 4-matic	2.143	150	4	07.2010-12.2016	OM651.924		EPBMBN3-A003Z	90717	28,9	400
E 250 CGI	1.796	150	4	01.2009-12.2015	M271.860		EPBMBN3-V007Z	96602		
E 300 CDI	2.987	150	6	12.2009-12.2010	OM642.850	; Position: Air Filter Housing	EPBMPN3-A004Z	90833	10	120
E 300 CDI	2.987	150	6	12.2009-12.2010	OM642.850		EPBBPN3-A011Z	91149	50	310
E 300 CDI / BlueTEC	2.987	170	6	11.2009-12.2016	OM642.850, OM642.852		EPBBPN3-A011Z	91149	50	310
E 300 CDI / BlueTEC	2.987	170	6	11.2009-12.2016	OM642.850, OM642.852	; Position: Air Filter Housing	EPBMPN3-A004Z	90833	10	120
E 350 BlueTEC	2.987	155	6	01.2009-12.2015	OM642.850	; Position: Air Filter Housing	EPBMPN3-A004Z	90833	10	120
E 350 BlueTEC	2.987	155	6	01.2009-12.2015	OM642.850		EPBBPN3-A011Z	91149	50	310
E 350 BlueTEC	2.987	155	6	11.2009-12.2013	OM642.850	; Position: Air Filter Housing	EPBMPN3-A004Z	90833	10	120
E 350 BlueTEC	2.987	155	6	11.2009-12.2013	OM642.850		EPBBPN3-A011Z	91149	50	310
E 350 BlueTEC	2.987	185	6	11.2012-12.2016	OM642.852	; Position: Air Filter Housing	EPBMPN3-A004Z	90833	10	120
E 350 BlueTEC	2.987	185	6	11.2012-12.2016	OM642.852		EPBBPN3-A011Z	91149	50	310
E 350 BlueTEC 4-matic	2.987	185	6	11.2012-12.2016	OM642.858	; Position: Air Filter Housing	EPBMPN3-A004Z	90833	10	120
E 350 BlueTEC 4-matic	2.987	185	6	11.2012-12.2016	OM642.858		EPBBPN3-A011Z	91149	50	310
E 350 BlueTEC	2.987	190	6	05.2014-12.2016	OM642.852	; Position: Air Filter Housing	EPBMPN3-A004Z	90833	10	120
E 350 BlueTEC	2.987	190	6	05.2014-12.2016	OM642.852		EPBBPN3-A011Z	91149	50	310



MAP



l kW
C
Y
I



Type-N°

Stock-N°

kPa from

kPa to

MERCEDES-BENZ

E-CLASS (S212, W212)

E 350 BlueTEC 4-matic	2.987	190	6	07.2014-12.2016	OM642.852, OM642.858	; Position: Air Filter Housing	EPBMPN3-A004Z	90833	10	120
E 350 BlueTEC 4-matic	2.987	190	6	07.2014-12.2016	OM642.852, OM642.858		EPBBPN3-A011Z	91149	50	310
E 350 CDI	2.987	170	6	01.2009-12.2015	OM642.850	; Position: Air Filter Housing	EPBMPN3-A004Z	90833	10	120
E 350 CDI	2.987	170	6	01.2009-12.2015	OM642.850		EPBBPN3-A011Z	91149	50	310
E 350 CDI	2.987	195	6	03.2011-12.2015	OM642.852	; Position: Air Filter Housing	EPBMPN3-A004Z	90833	10	120
E 350 CDI	2.987	195	6	03.2011-12.2015	OM642.852		EPBBPN3-A011Z	91149	50	310
E 350 CDI 4-matic	2.987	170	6	09.2009-12.2011	OM642.856	; Position: Air Filter Housing	EPBMPN3-A004Z	90833	10	120
E 350 CDI 4-matic	2.987	170	6	09.2009-12.2011	OM642.856		EPBBPN3-A011Z	91149	50	310
E 350 CDI 4-matic	2.987	195	6	03.2011-12.2015	OM642.858	; Position: Air Filter Housing	EPBMPN3-A004Z	90833	10	120
E 350 CDI 4-matic	2.987	195	6	03.2011-12.2015	OM642.858		EPBBPN3-A011Z	91149	50	310

E-CLASS (S213, W213)

E 350 d	2.987	190	6	01.2016-05.2018	OM642.855		EPBBPN3-A011Z	91149	50	310
---------	-------	-----	---	-----------------	-----------	--	---------------	-------	----	-----

E-CLASS COUPE / CABRIOLET (A207, C207)

E 200 CGI	1.796	135	4	01.2010-12.2016	M271.820, M271.860		EPBMBN3-V007Z	96602		
E 220 CDI	2.143	120	4	02.2010-12.2014	OM651.911		EPBMBN3-V007Z	96602		
E 220 CDI / BlueTEC / d	2.143	125	4	01.2010-12.2016	OM651.911		EPBMBN3-A003Z	90717	28,9	400
E 250 CDI / BlueTEC / d	2.143	150	4	01.2009-12.2016	OM651.911		EPBMBN3-A003Z	90717	28,9	400
E 250 CGI	1.796	150	4	01.2009-12.2016	M271.860		EPBMBN3-V007Z	96602		
E 350 CDI	2.987	170	6	01.2009-12.2011	OM642.836	; Position: Air Filter Housing	EPBMPN3-A004Z	90833	10	120
E 350 CDI	2.987	170	6	01.2009-12.2011	OM642.836		EPBBPN3-A011Z	91149	50	310
E 350 BlueTEC	2.987	185	6	06.2013-12.2016	OM642.838	; Position: Air Filter Housing	EPBMPN3-A004Z	90833	10	120
E 350 BlueTEC	2.987	185	6	06.2013-12.2016	OM642.838		EPBBPN3-A011Z	91149	50	310
E 350 BlueTEC / d	2.987	190	6	05.2014-12.2016	OM642.838	; Position: Air Filter Housing	EPBMPN3-A004Z	90833	10	120
E 350 BlueTEC / d	2.987	190	6	05.2014-12.2016	OM642.838		EPBBPN3-A011Z	91149	50	310
E 350 CDI	2.987	195	6	04.2011-12.2013	OM642.838	; Position: Air Filter Housing	EPBMPN3-A004Z	90833	10	120
E 350 CDI	2.987	195	6	04.2011-12.2013	OM642.838		EPBBPN3-A011Z	91149	50	310

G-CLASS (W461)

G 270 CDI	2.685	115	5	01.2003-	OM612.966		EPBBPN3-A002Z	94523	15	260
G 280 CDI	2.987	135	6	04.2009-	OM642.884, OM642.975		EPBBPN3-A011Z	91149	50	310
G 300 CDI	2.987	135	6	04.2010-	OM642.884	; Position: Air Filter Housing	EPBMPN3-A004Z	90833	10	120

G-CLASS (W463)

G 270 CDI	2.685	115	5	10.2001-	OM612.965		EPBBPN3-A002Z	94523	15	260
G 300 TD	2.996	130	6	08.1996-07.2000	OM606.964		EPBBPN3-A009Z	96930	50	250
G 320	3.199	158	6	01.2001-	M112.945	; Position: Intake Manifold	EPBMPN3-A004Z	90833	10	120
G 320 CDI	2.987	165	6	09.2006-	OM642.970	; Position: Air Filter Housing	EPBMPN3-A004Z	90833	10	120
G 320 CDI	2.987	165	6	09.2006-	OM642.970		EPBBPN3-A011Z	91149	50	310
G 350 CDI	2.987	155	6	07.2011-	OM642.886	; Position: Air Filter Housing	EPBMPN3-A004Z	90833	10	120





MERCEDES-BENZ

G-CLASS (W463)

G 350 CDI	2.987	155	6	07.2011-	OM642.886		EPBBPN3-A011Z	91149	50	310
G 350 d	2.987	180	6	06.2015-	OM642.887		EPBBPN3-A011Z	91149	50	310
G 400 CDI	3.996	184	8	12.2000-	OM628.962	; Position: Suction Pipe	EPBMPN3-A004Z	90833	10	120
G 400 CDI	3.996	184	8	12.2000-	OM628.962		EPBBPN3-A002Z	94523	15	260
G 500	4.966	218	8	04.1998-	M113.962	; Position: Intake Manifold	EPBMPN3-A004Z	90833	10	120
G 500	4.966	218	8	04.1998-	M113.962	; Position: Suction Pipe	EPBMPN3-A004Z	90833	10	120
G 500	5.461	285	8	05.2008-	M273.963	; Position: Suction Pipe	EPBMPN3-A004Z	90833	10	120
G 55 AMG	5.439	260	8	04.1999-	M113.982	; Position: Intake Manifold	EPBMPN3-A004Z	90833	10	120
G 55 AMG	5.439	350	8	06.2004-	M113.993		EPBBPN3-A002Z	94523	15	260
G 55 AMG	5.439	368	8	08.2006-	M113.993		EPBBPN3-A002Z	94523	15	260
G 55 AMG	5.439	373	8	08.2008-	M113.993		EPBBPN3-A002Z	94523	15	260
G 65 AMG	5.980	450	12	05.2012-	M279.982	; Position: Air Filter Housing; 2↑	EPBMPN3-A004Z	90833	10	120

GLC / GLC COUPE (C253, X253)

220 d 4-matic	2.143	120	4	06.2015-04.2019	OM651.921		EPBMBN3-V007Z	96602		
220 d 4-matic	2.143	125	4	06.2015-04.2019	OM651.921		EPBMBN3-V007Z	96602		
250 d 4-matic	2.143	150	4	06.2015-04.2019	OM651.921		EPBMBN3-V007Z	96602		

GL-CLASS (X164)

GL 320 CDI / 350 BlueTEC 4-matic	2.987	155	6	12.2009-08.2012	OM642.820		EPBBPN3-A011Z	91149	50	310
GL 320 CDI 4-matic	2.987	165	6	09.2006-05.2009	OM642.940		EPBBPN3-A011Z	91149	50	310
GL 350 CDI 4-matic	2.987	165	6	05.2009-08.2012	OM642.940		EPBBPN3-A011Z	91149	50	310
GL 350 CDI 4-matic	2.987	195	6	10.2010-08.2012	OM642.822		EPBBPN3-A011Z	91149	50	310
GL 420 CDI 4-matic	3.996	225	8	09.2006-05.2009	OM629.912	; Position: Intake Manifold	EPBMPN3-A004Z	90833	10	120
GL 420 CDI 4-matic	3.996	225	8	09.2006-05.2009	OM629.912		EPBBPN3-A011Z	91149	50	310
GL 450 4-matic	4.663	250	8	09.2006-08.2012	M273.923	; Position: Intake Manifold	EPBMPN3-A004Z	90833	10	120
GL 450 CDI 4-matic	3.996	225	8	05.2009-08.2012	OM629.912	; Position: Intake Manifold	EPBMPN3-A004Z	90833	10	120
GL 450 CDI 4-matic	3.996	225	8	05.2009-08.2012	OM629.912		EPBBPN3-A011Z	91149	50	310
GL 500 4-matic	5.461	285	8	09.2006-12.2012	M273.963	; Position: Intake Manifold	EPBMPN3-A004Z	90833	10	120

GL-CLASS (X166)

GL 350 CDI / BlueTec 4-matic	2.987	190	6	07.2012-10.2015	OM642.826	; Position: Air Filter Housing	EPBMPN3-A004Z	90833	10	120
GL 350 CDI / BlueTec 4-matic	2.987	190	6	07.2012-10.2015	OM642.826		EPBBPN3-A011Z	91149	50	310

GLE / GLE COUPE (C292, W166)

250 d	2.143	150	4	04.2015-10.2018	OM651.960		EPBMBN3-V007Z	96602		
250 d 4-matic	2.143	150	4	04.2015-10.2018	OM651.960		EPBMBN3-V007Z	96602		
350 d 4-matic	2.987	190	6	03.2015-10.2019	OM642.824, OM642.826		EPBBPN3-A011Z	91149	50	310

GLK-CLASS (X204)

200 CDI	2.143	105	4	07.2010-06.2015	OM651.913, OM651.916		EPBMBN3-A003Z	90717	28,9	400
220 CDI	2.143	120	4	12.2008-06.2015	OM651.916	; Position: Air Filter Housing	EPBMPN3-A004Z	90833	10	120
220 CDI 4-matic	2.143	120	4	12.2008-06.2015	OM651.912	; Position: Air Filter Housing	EPBMPN3-A004Z	90833	10	120

MAP



l kW
C
Y
I



Type-N°

Stock-N°

kPa from
kPa to

MERCEDES-BENZ

GLK-CLASS (X204)

220 CDI	2.143	125	4	12.2008-06.2015	OM651.916	; Position: Air Filter Housing	EPBMPN3-A004Z	90833	10	120
220 CDI	2.143	125	4	04.2009-	OM651.916		EPBMBN3-A003Z	90717	28,9	400
220 CDI 4-matic	2.143	125	4	12.2008-06.2015	OM651.912	; Position: Air Filter Housing	EPBMPN3-A004Z	90833	10	120
220 CDI 4-matic	2.143	125	4	12.2008-06.2015	OM651.912		EPBMBN3-A003Z	90717	28,9	400
250 CDI 4-matic	2.143	150	4	09.2009-06.2015	OM651.912	; Position: Air Filter Housing	EPBMPN3-A004Z	90833	10	120
250 CDI 4-matic	2.143	150	4	09.2009-06.2015	OM651.912		EPBMBN3-A003Z	90717	28,9	400
320 CDI 4-matic	2.987	165	6	06.2008-06.2015	OM642.961	; Position: Air Filter Housing	EPBMPN3-A004Z	90833	10	120
320 CDI 4-matic	2.987	165	6	06.2008-06.2015	OM642.961		EPBBPN3-A011Z	91149	50	310
350 CDI 4-matic	2.987	165	6	07.2009-01.2010	OM642.832	; Position: Air Filter Housing	EPBMPN3-A004Z	90833	10	120
350 CDI 4-matic	2.987	165	6	07.2009-01.2010	OM642.832		EPBBPN3-A011Z	91149	50	310
350 CDI 4-matic	2.987	170	6	02.2010-06.2015	OM642.832	; Position: Air Filter Housing	EPBMPN3-A004Z	90833	10	120
350 CDI 4-matic	2.987	170	6	02.2010-06.2015	OM642.832		EPBBPN3-A011Z	91149	50	310
350 CDI 4-matic	2.987	195	6	07.2012-06.2015	OM642.835	; Position: Air Filter Housing	EPBMPN3-A004Z	90833	10	120
350 CDI 4-matic	2.987	195	6	07.2012-06.2015	OM642.835		EPBBPN3-A011Z	91149	50	310
350	3.498	200	6	04.2009-06.2015	M272.991	; Position: Intake Manifold	EPBMPN3-A004Z	90833	10	120
350 4-matic	3.498	200	6	06.2008-04.2011	M272.971	; Position: Intake Manifold	EPBMPN3-A004Z	90833	10	120

M-CLASS (W163)

ML 350	3.724	173	6	02.2003-06.2005	M112.970	; Position: Intake Manifold	EPBMPN3-A004Z	90833	10	120
ML 350	3.724	180	6	08.2002-06.2005	M112.970	; Position: Intake Manifold	EPBMPN3-A004Z	90833	10	120
ML 400 CDI	3.996	184	8	09.2001-06.2005	OM628.963		EPBBPN3-A002Z	94523	15	260
ML 430	4.266	200	8	01.2001-	M113.942	; Position: Intake Manifold	EPBMPN3-A004Z	90833	10	120
ML 500	4.966	215	8	09.2001-06.2005	M113.965	; Position: Intake Manifold	EPBMPN3-A004Z	90833	10	120

M-CLASS (W164)

ML 280 CDI 4-matic	2.987	140	6	07.2005-07.2009	OM642.940	; Position: Air Filter Housing	EPBMPN3-A004Z	90833	10	120
ML 280 CDI 4-matic	2.987	140	6	07.2005-07.2009	OM642.940		EPBBPN3-A011Z	91149	50	310
ML 300 CDI 4-matic	2.987	140	6	07.2009-12.2011	OM642.940		EPBBPN3-A011Z	91149	50	310
ML 300 CDI 4-matic	2.987	150	6	02.2010-12.2011	OM642.820	; Position: Air Filter Housing	EPBMPN3-A004Z	90833	10	120
ML 300 CDI 4-matic	2.987	150	6	02.2010-12.2011	OM642.820		EPBBPN3-A011Z	91149	50	310
ML 350 CDI 4-matic	2.987	155	6	09.2009-12.2011	OM642.820	; Position: Air Filter Housing	EPBMPN3-A004Z	90833	10	120
ML 350 CDI 4-matic	2.987	155	6	09.2009-12.2011	OM642.820		EPBBPN3-A011Z	91149	50	310
ML 350 CDI 4-matic	2.987	165	6	07.2009-12.2011	OM642.940		EPBBPN3-A011Z	91149	50	310
ML 350 CDI 4-matic	2.987	170	6	02.2010-12.2011	OM642.820		EPBBPN3-A011Z	91149	50	310
ML 420 CDI 4-matic	3.996	225	8	02.2006-09.2009	OM629.912	; Position: Intake Manifold	EPBMPN3-A004Z	90833	10	120
ML 420 CDI 4-matic	3.996	225	8	02.2006-09.2009	OM629.912		EPBBPN3-A011Z	91149	50	310
ML 450 CDI 4-matic	3.996	225	8	09.2009-12.2011	OM629.912	; Position: Intake Manifold	EPBMPN3-A004Z	90833	10	120
ML 450 CDI 4-matic	3.996	225	8	09.2009-12.2011	OM629.912		EPBBPN3-A011Z	91149	50	310
ML 500 4-matic	4.966	225	8	07.2005-12.2011	M113.964	; Position: Intake Manifold	EPBMPN3-A004Z	90833	10	120





Type-Nº

Stock-Nº

kPa from
kPa to

MERCEDES-BENZ

M-CLASS (W166)

ML 250 CDI / BlueTEC 4-matic	2.143	150	4	06.2011-12.2015	OM651.960	; Position: Air Filter Housing	EPBMPN3-A004Z	90833	10	120
ML 250 CDI / BlueTEC 4-matic	2.143	150	4	06.2011-12.2015	OM651.960		EPBMBN3-A003Z	90717	28,9	400
ML 350 BlueTEC 4-matic	2.987	190	6	06.2011-02.2015	OM642.826	; Position: Air Filter Housing	EPBMPN3-A004Z	90833	10	120
ML 350 BlueTEC 4-matic	2.987	190	6	06.2011-02.2015	OM642.826, OM642.864		EPBBPN3-A011Z	91149	50	310

R-CLASS (W251, V251)

R 280 CDI	2.987	140	6	05.2006-12.2012	OM642.872	; Position: Air Filter Housing	EPBMPN3-A004Z	90833	10	120
R 280 CDI	2.987	140	6	05.2006-12.2012	OM642.870, OM642.872, OM642.950		EPBBPN3-A011Z	91149	50	310
R 280 CDI 4-matic	2.987	140	6	05.2006-12.2012	OM642.950		EPBBPN3-A011Z	91149	50	310
R 300 CDI	2.987	140	6	07.2009-12.2012	OM642.870, OM642.872, OM642.950	; Position: Air Filter Housing	EPBMPN3-A004Z	90833	10	120
R 300 CDI	2.987	140	6	07.2009-12.2012	OM642.870, OM642.872, OM642.950		EPBBPN3-A011Z	91149	50	310
R 300 CDI 4-matic	2.987	140	6	07.2009-12.2012	OM642.950		EPBBPN3-A011Z	91149	50	310
R 320 CDI 4-matic	2.987	155	6	01.2006-12.2012	OM642.870	; Position: Air Filter Housing	EPBMPN3-A004Z	90833	10	120
R 320 CDI 4-matic	2.987	155	6	01.2006-12.2012	OM642.870, OM642.950		EPBBPN3-A011Z	91149	50	310
R 320 CDI 4-matic	2.987	165	6	01.2006-07.2010	OM642.950		EPBBPN3-A011Z	91149	50	310
R 350 CDI 4-matic	2.987	155	6	01.2006-12.2014	OM642.870	; Position: Air Filter Housing	EPBMPN3-A004Z	90833	10	120
R 350 CDI 4-matic	2.987	155	6	01.2006-12.2014	OM642.870, OM642.950		EPBBPN3-A011Z	91149	50	310
R 350 CDI 4-matic	2.987	165	6	07.2009-12.2012	OM642.950		EPBBPN3-A011Z	91149	50	310
R 350 CDI 4-matic	2.987	195	6	08.2010-12.2014	OM642.872	; Position: Air Filter Housing	EPBMPN3-A004Z	90833	10	120
R 350 CDI 4-matic	2.987	195	6	08.2010-12.2014	OM642.872		EPBBPN3-A011Z	91149	50	310

S-CLASS (W140)

S 420	4.196	205	8	01.1993-10.1998	M119.971		EPBMPN3-A038Z	94914	50	450
S 500	4.973	235	8	01.1993-10.1998	M119.970, M119.980		EPBMPN3-A038Z	94914	50	450
S 600	5.987	290	12	01.1993-10.1998	M120.980, M120.982		EPBMPN3-A038Z	94914	50	450

S-CLASS (W220)

S 320 CDI	3.222	145	6	08.1999-09.2002	OM613.960		EPBBPN3-A002Z	94523	15	260
S 320 CDI	3.222	150	6	09.2002-08.2005	OM648.960	; Position: Air Filter Housing	EPBMPN3-A004Z	90833	10	120
S 320 CDI	3.222	150	6	09.2002-08.2005	OM648.960		EPBBPN3-A002Z	94523	15	260
S 320	3.199	165	6	10.1998-08.2005	M112.944		EPBMPN3-A038Z	94914	50	450
S 400 CDI	3.996	184	8	06.2000-08.2005	OM628.960		EPBBPN3-A002Z	94523	15	260
S 400 CDI	3.996	191	8	06.2003-08.2005	OM628.960		EPBBPN3-A002Z	94523	15	260
S 430	4.266	205	8	10.1998-08.2005	M113.941		EPBMPN3-A038Z	94914	50	450
S 500	4.966	225	8	10.1998-08.2005	M113.960, M113.966		EPBMPN3-A038Z	94914	50	450
S 55 AMG Kompressor	5.439	368	8	06.2002-08.2005	M113.991		EPBBPN3-A002Z	94523	15	260
S 600	5.513	368	12	09.2002-08.2005	M275.950		EPBBPN3-A002Z	94523	15	260
S 65 AMG	5.980	450	12	03.2004-08.2005	M275.980		EPBBPN3-A002Z	94523	15	260

MAP



l kW
C
Y
I



Type-N°

Stock-N°

kPa from
kPa to

MERCEDES-BENZ

S-CLASS (W221)

S 250 CDI	2.143	150	4	01.2011-12.2013	OM651.961	; Position: Air Filter Housing	EPBMPN3-A004Z	90833	10	120
S 250 CDI	2.143	150	4	01.2011-12.2013	OM651.961		EPBMBN3-A003Z	90717	28,9	400
S 320 CDI 4-matic	2.987	155	6	10.2005-12.2013	OM642.932	; Position: Air Filter Housing	EPBMPN3-A004Z	90833	10	120
S 320 CDI	2.987	173	6	12.2005-06.2009	OM642.930	; Position: Air Filter Housing	EPBMPN3-A004Z	90833	10	120
S 320 CDI 4-matic	2.987	173	6	10.2006-12.2013	OM642.932		EPBBPN3-A011Z	91149	50	310
S 350 CDI	2.987	173	6	06.2009-12.2013	OM642.930	; Position: Air Filter Housing	EPBMPN3-A004Z	90833	10	120
S 350 BlueTec	2.987	190	6	04.2011-12.2013	OM642.862	; Position: Air Filter Housing	EPBMPN3-A004Z	90833	10	120
S 350 BlueTec	2.987	190	6	04.2011-12.2013	OM642.862		EPBBPN3-A011Z	91149	50	310
S 350 BlueTEC 4-matic	2.987	190	6	04.2011-12.2013	OM642.868	; Position: Air Filter Housing	EPBMPN3-A004Z	90833	10	120
S 350 BlueTEC 4-matic	2.987	190	6	04.2011-12.2013	OM642.868		EPBBPN3-A011Z	91149	50	310
S 350	3.498	200	6	10.2005-12.2013	M272.965	; Position: Intake Manifold	EPBMPN3-A004Z	90833	10	120
S 350 4-matic	3.498	200	6	02.2008-12.2013	M272.975	; Position: Intake Manifold	EPBMPN3-A004Z	90833	10	120
S 420 CDI	3.996	235	8	10.2006-12.2009	OM629.911		EPBBPN3-A011Z	91149	50	310
S 600	5.513	380	12	12.2005-12.2013	M275.953		EPBBPN3-A002Z	94523	15	260
S 65 AMG	5.980	450	12	07.2006-02.2011	M275.982		EPBBPN3-A002Z	94523	15	260
S 65 AMG	5.980	463	12	10.2010-12.2013	M275.982		EPBBPN3-A002Z	94523	15	260

S-CLASS (W222, V222, X222)

S 350 BlueTEC 4-matic	2.987	185	6	02.2014-05.2017	OM642.867	; Position: Air Filter Housing	EPBMPN3-A004Z	90833	10	120
S 350 BlueTEC 4-matic	2.987	185	6	02.2014-05.2017	OM642.867		EPBBPN3-A011Z	91149	50	310
S 350 BlueTEC / d	2.987	190	6	05.2013-05.2017	OM642.861	; Position: Air Filter Housing	EPBMPN3-A004Z	90833	10	120
S 350 BlueTEC / d	2.987	190	6	05.2013-05.2017	OM642.861		EPBBPN3-A011Z	91149	50	310
S 350 BlueTEC / d 4-matic	2.987	190	6	02.2014-05.2017	OM642.867	; Position: Air Filter Housing	EPBMPN3-A004Z	90833	10	120
S 350 BlueTEC / d 4-matic	2.987	190	6	02.2014-05.2017	OM642.861, OM642.867		EPBBPN3-A011Z	91149	50	310

S-CLASS COUPE (C215)

CL 55 AMG	5.439	265	8	10.1999-03.2006	M113.986	; Position: Suction Pipe	EPBMPN3-A004Z	90833	10	120
CL 55 AMG Kompressor	5.439	368	8	06.2002-03.2006	M113.991		EPBBPN3-A002Z	94523	15	260
CL 600	5.513	368	12	09.2002-03.2006	M275.950		EPBBPN3-A002Z	94523	15	260
CL 65 AMG	5.980	450	12	09.2003-03.2006	M275.980		EPBBPN3-A002Z	94523	15	260

S-CLASS COUPE (C216)

CL 500	5.461	285	8	06.2006-12.2013	M273.961	; Position: Intake Manifold	EPBMPN3-A004Z	90833	10	120
CL 500 4-matic	5.461	285	8	02.2008-12.2013	M273.968	; Position: Intake Manifold	EPBMPN3-A004Z	90833	10	120
CL 600	5.513	380	12	05.2006-12.2013	M275.953		EPBBPN3-A002Z	94523	15	260
CL 65 AMG	5.980	450	12	09.2007-07.2010	M275.982		EPBBPN3-A002Z	94523	15	260
CL 65 AMG	5.980	463	12	02.2011-12.2013	M275.982		EPBBPN3-A002Z	94523	15	260

S-CLASS COUPE / CABRIOLET (A217, C217)

AMG S 65	5.980	463	12	04.2016-05.2019	M279.980		EPBMBN3-V007Z	96602		
----------	-------	-----	----	-----------------	----------	--	---------------	-------	--	--

SL (R129)

320	3.199	170	6	09.1993-10.2001	M104.991		EPBMPN3-A038Z	94914	50	450
-----	-------	-----	---	-----------------	----------	--	---------------	-------	----	-----



MAP



l kW
C
Y
I



Type-N°

Stock-N°

kPa from

kPa to

MERCEDES-BENZ

SL (R129)

500	4.973	235	8	09.1992-10.2001	M119.972, M119.982		EPBMPN3-A038Z	94914	50	450
600	5.987	290	12	07.1992-10.2001	M120.981, M120.983		EPBMPN3-A038Z	94914	50	450

SL (R230)

55 AMG	5.439	350	8	10.2001-06.2002	M113.992		EPBBPN3-A002Z	94523	15	260
55 AMG Kompressor	5.439	368	8	06.2002-01.2012	M113.992		EPBBPN3-A002Z	94523	15	260
55 AMG	5.439	380	8	03.2006-01.2012	M113.995		EPBBPN3-A002Z	94523	15	260
600	5.513	368	12	04.2003-01.2012	M275.951		EPBBPN3-A002Z	94523	15	260
600	5.513	380	12	03.2006-01.2012	M275.954		EPBBPN3-A002Z	94523	15	260
65 AMG	5.980	450	12	03.2004-01.2012	M275.981		EPBBPN3-A002Z	94523	15	260

SLC (R172)

250 d	2.143	150	4	01.2016-10.2017	OM651.980		EPBMBN3-V007Z	96602		
-------	-------	-----	---	-----------------	-----------	--	---------------	-------	--	--

SLK (R170)

200 Kompressor	1.998	120	4	03.2000-04.2004	M111.958		EPBBPN3-A002Z	94523	15	260
230 Kompressor	2.295	142	4	09.1996-03.2000	M111.973		EPBMPN3-A038Z	94914	50	450
230 Kompressor	2.295	145	4	03.2000-04.2004	M111.983		EPBBPN3-A002Z	94523	15	260
230 Kompressor	2.295	145	4	03.2000-04.2004	M111.983		EPBMPN3-A038Z	94914	50	450
320	3.199	160	6	03.2000-04.2004	M112.947	; Position: Suction Pipe	EPBMPN3-A004Z	90833	10	120
32 AMG Kompressor	3.199	260	6	03.2001-04.2004	M112.960		EPBBPN3-A002Z	94523	15	260

SLK (R171)

200 Kompressor	1.795	120	4	03.2004-02.2011	M271.944		EPBBPN3-A002Z	94523	15	260
200 Kompressor	1.796	135	4	01.2008-02.2011	M271.954		EPBBPN3-A002Z	94523	15	260
55 AMG	5.439	265	8	06.2004-02.2011	M113.989	; Position: Suction Pipe	EPBMPN3-A004Z	90833	10	120
55 AMG	5.439	294	8	06.2006-02.2011	M113.989	; Position: Suction Pipe	EPBMPN3-A004Z	90833	10	120

SLK (R172)

250 CDI / d	2.143	150	4	01.2012-	OM651.980		EPBMBN3-A003Z	90717	28,9	400
-------------	-------	-----	---	----------	-----------	--	---------------	-------	------	-----

SLR (R199)

5.4	5.439	460	8	04.2004-	M155.980		EPBBPN3-A002Z	94523	15	260
5.4	5.439	478	8	10.2006-	M155.980		EPBBPN3-A002Z	94523	15	260

SPRINTER (901, 902)

208 CDI	2.148	60	4	04.2000-05.2006	OM611.987		EPBBPN3-A002Z	94523	15	260
211 CDI	2.148	80	4	04.2000-05.2006	OM611.981		EPBBPN3-A002Z	94523	15	260
213 CDI	2.148	95	4	04.2000-05.2006	OM611.981		EPBBPN3-A002Z	94523	15	260
216 CDI	2.685	115	5	04.2000-05.2006	OM612.981		EPBBPN3-A002Z	94523	15	260

SPRINTER (903)

308 CDI	2.148	60	4	04.2000-05.2006	OM611.987		EPBBPN3-A002Z	94523	15	260
311 CDI	2.148	80	4	04.2000-05.2006	OM611.981		EPBBPN3-A002Z	94523	15	260
311 CDI 4x4	2.148	80	4	08.2002-05.2006	OM611.981		EPBBPN3-A002Z	94523	15	260
313 CDI	2.148	95	4	04.2000-05.2006	OM611.981		EPBBPN3-A002Z	94523	15	260
313 CDI 4x4	2.148	95	4	08.2002-05.2006	OM611.981		EPBBPN3-A002Z	94523	15	260



MAP



l kW
C
Y
I



Type-N°

Stock-N°

kPa from
kPa to

MERCEDES-BENZ

SPRINTER (903)

316 CDI	2.685	115	5	04.2000-05.2006	OM612.981, OM647.981		EPBBPN3-A002Z	94523	15	260
316 CDI 4x4	2.685	115	5	08.2002-05.2006	OM612.981, OM647.981		EPBBPN3-A002Z	94523	15	260

SPRINTER (904)

408 CDI	2.148	60	4	04.2000-05.2006	OM611.987		EPBBPN3-A002Z	94523	15	260
411 CDI	2.148	80	4	04.2000-05.2006	OM611.981		EPBBPN3-A002Z	94523	15	260
411 CDI 4x4	2.148	80	4	04.2000-05.2006	OM611.981		EPBBPN3-A002Z	94523	15	260
413 CDI	2.148	95	4	04.2000-05.2006	OM611.981		EPBBPN3-A002Z	94523	15	260
413 CDI 4x4	2.148	95	4	04.2000-05.2006	OM611.981		EPBBPN3-A002Z	94523	15	260
416 CDI	2.685	115	5	04.2000-05.2006	OM612.981, OM647.981		EPBBPN3-A002Z	94523	15	260
416 CDI 4x4	2.685	115	5	04.2000-05.2006	OM612.981, OM647.981		EPBBPN3-A002Z	94523	15	260

SPRINTER (905)





























616 CDI	2.685	115	5	04.2001-05.2006	OM612.981		EPBBPN3-A002Z	94523	15	260
---------	-------	-----	---	-----------------	-----------	--	---------------	-------	----	-----

SPRINTER (906)

209 CDI	2.148	65	4	06.2006-12.2009	OM646.984		EPBBPN3-A011Z	91149	50	310
210 CDI	2.143	70	4	03.2009-05.2016	OM651.955	; Position: Air Filter Housing	EPBMPN3-A004Z	90833	10	120
210 CDI	2.143	70	4	03.2009-05.2016	OM651.955		EPBMBN3-A003Z	90717	28,9	400
211 CDI	2.148	80	4	06.2006-12.2009	OM646.985		EPBBPN3-A011Z	91149	50	310
211 CDI	2.143	84	4	04.2016-	OM651.955		EPBMBN3-V007Z	96602		
213 CDI	2.143	95	4	03.2009-05.2016	OM651.955, OM651.957		EPBMBN3-A003Z	90717	28,9	400
213 CDI	2.148	95	4	-03.2009	OM646.986		EPBMBN3-A003Z	90717	28,9	400
213 CDI	2.148	95	4	06.2006-12.2009	OM646.986		EPBBPN3-A011Z	91149	50	310
214 CDI	2.143	105	4	04.2016-	OM651.955		EPBMBN3-V007Z	96602		
215 CDI	2.148	110	4	06.2006-12.2009	OM646.986, OM646.989, OM646.990		EPBBPN3-A002Z	94523	15	260
215 CDI	2.148	110	4	06.2006-12.2009	OM646.986, OM646.989, OM646.990		EPBMBN3-A003Z	90717	28,9	400
215 CDI	2.148	110	4	06.2006-12.2009	OM646.986, OM646.989, OM646.990		EPBBPN3-A011Z	91149	50	310
216	1.796	115	4	09.2008-05.2016	M271.951		EPBBPN3-A002Z	94523	15	260
216 CDI	2.143	120	4	03.2009-	OM651.955, OM651.957		EPBMBN3-A003Z	90717	28,9	400
218 CDI	2.987	135	6	06.2006-12.2009	OM642.896, OM642.992, OM642.993		EPBBPN3-A011Z	91149	50	310
219 CDI / BlueTEC	2.987	140	6	03.2009-05.2016	OM642.896, OM642.992		EPBBPN3-A011Z	91149	50	310
309 CDI	2.148	65	4	06.2006-12.2009	OM646.984		EPBBPN3-A011Z	91149	50	310
310 CDI	2.143	70	4	03.2009-05.2016	OM651.955, OM651.956		EPBMBN3-A003Z	90717	28,9	400
310 CDI	2.143	70	4	03.2009-12.2013	OM651.955, OM651.956	; Position: Air Filter Housing	EPBMPN3-A004Z	90833	10	120
311 CDI	2.148	80	4	06.2006-12.2009	OM646.985		EPBBPN3-A011Z	91149	50	310
311 CDI 4x4	2.148	80	4	02.2008-12.2009	OM646.985		EPBBPN3-A011Z	91149	50	310
311 CDI	2.143	84	4	05.2016-	OM651.955		EPBMBN3-V007Z	96602		



MERCEDES-BENZ
SPRINTER (906)

313 CDI	2.148	95	4	-03.2009	OM646.986		EPBMBN3-A003Z	90717	28,9	400
313 CDI	2.143	95	4	03.2009-	OM651.955, OM651.956		EPBMBN3-A003Z	90717	28,9	400
313 CDI	2.143	95	4	06.2006- 05.2016	OM651.955, OM651.956	 ; Position: Air Filter Housing	EPBMPN3-A004Z	90833	10	120
313 CDI	2.148	95	4	06.2006- 05.2016	OM646.986		EPBBPN3-A011Z	91149	50	310
313 CDI 4x4	2.143	95	4	05.2009-	OM651.955	 ; Position: Air Filter Housing	EPBMPN3-A004Z	90833	10	120
314 CDI	2.143	105	4	05.2016-	OM651.955		EPBMBN3-V007Z	96602		
314 CDI 4x4	2.143	105	4	05.2016-	OM651.955		EPBMBN3-V007Z	96602		
315 CDI	2.148	110	4	06.2006- 12.2009	OM646.986, OM646.989, OM646.990		EPBBPN3-A002Z	94523	15	260
315 CDI	2.148	110	4	06.2006- 12.2009	OM646.986, OM646.989, OM646.990		EPBMBN3-A003Z	90717	28,9	400
315 CDI	2.148	110	4	06.2006- 12.2009	OM646.986, OM646.989, OM646.990		EPBBPN3-A011Z	91149	50	310
315 CDI 4x4	2.148	110	4	02.2008- 12.2009	OM646.986, OM646.989, OM646.990		EPBBPN3-A002Z	94523	15	260
315 CDI 4x4	2.148	110	4	02.2008- 12.2009	OM646.986, OM646.989, OM646.990		EPBMBN3-A003Z	90717	28,9	400
315 CDI 4x4	2.148	110	4	02.2008- 12.2009	OM646.986, OM646.989, OM646.990		EPBBPN3-A011Z	91149	50	310
316	1.796	115	4	09.2008-	M271.951		EPBBPN3-A002Z	94523	15	260
316 LGT	1.796	115	4	09.2008-	M271.951		EPBBPN3-A002Z	94523	15	260
316 NGT	1.796	115	4	09.2008-	M271.951		EPBBPN3-A002Z	94523	15	260
316 CDI	2.143	120	4	03.2009-	OM651.955, OM651.957		EPBMBN3-A003Z	90717	28,9	400
316 CDI	2.143	120	4	03.2009-	OM651.955	 ; Position: Air Filter Housing	EPBMPN3-A004Z	90833	10	120
316 CDI 4x4	2.143	120	4	03.2009-	OM651.955, OM651.957		EPBMBN3-A003Z	90717	28,9	400
316 CDI 4x4	2.143	120	4	08.2011-	OM651.957, OM651.955	 ; Position: Air Filter Housing	EPBMPN3-A004Z	90833	10	120
318 CDI	2.987	135	6	06.2006- 12.2009	OM642.896, OM642.986, OM642.992, OM642.993		EPBBPN3-A011Z	91149	50	310
318 CDI	2.987	135	6	02.2008- 12.2009	OM642.992, OM642.993, OM642.896	 ; Position: Air Filter Housing	EPBMPN3-A004Z	90833	10	120
318 CDI 4x4	2.987	135	6	02.2008- 12.2009	OM642.896, OM642.986, OM642.992, OM642.993		EPBBPN3-A011Z	91149	50	310
319 CDI / BlueTEC	2.987	140	6	03.2009-	OM642.992, OM642.896, OM642.898	 ; Position: Air Filter Housing	EPBMPN3-A004Z	90833	10	120
319 CDI / BlueTEC	2.987	140	6	03.2009-	OM642.896, OM642.898, OM642.986, OM642.992		EPBBPN3-A011Z	91149	50	310
319 CDI / BlueTEC 4x4	2.987	140	6	03.2009-	OM642.896, OM642.898, OM642.986, OM642.992		EPBBPN3-A011Z	91149	50	310
411 CDI	2.148	80	4	06.2009- 12.2018	OM646.985		EPBBPN3-A011Z	91149	50	310
414 CDI	2.143	105	4	05.2016-	OM651.955		EPBMBN3-V007Z	96602		
415 CDI	2.148	110	4	-03.2009	OM646.986, OM646.989, OM646.990		EPBBPN3-A002Z	94523	15	260

MAP



l kW
C
Y
I



Type-N°

Stock-N°

kPa from
kPa to

MERCEDES-BENZ









SPRINTER (906)

415 CDI	2.148	110	4	-03.2009	OM646.986, OM646.989, OM646.990		EPBMBN3-A003Z	90717	28,9	400
415 CDI	2.148	110	4	06.2006- 12.2009	OM646.986, OM646.989, OM646.990		EPBBPN3-A011Z	91149	50	310
415 CDI	2.148	110	4	06.2006- 12.2009	OM646.990, OM646.989	; Position: Air Filter Housing	EPBMPN3-A004Z	90833	10	120
415 CDI	2.148	110	4	06.2009- 12.2009	OM646.986, OM646.989, OM646.990		EPBBPN3-A002Z	94523	15	260
416 CDI	2.143	120	4	03.2009-	OM651.957	; Position: Air Filter Housing	EPBMPN3-A004Z	90833	10	120
416 CDI	2.143	120	4	03.2009-	OM651.955, OM651.957		EPBMBN3-A003Z	90717	28,9	400
418 CDI	2.987	135	6	06.2006- 12.2009	OM642.896, OM642.986, OM642.992, OM642.993		EPBBPN3-A011Z	91149	50	310
418 CDI	2.987	135	6	06.2009- 05.2016	OM642.992, OM642.993, OM642.896	; Position: Air Filter Housing	EPBMPN3-A004Z	90833	10	120
419 CDI	2.987	140	6	03.2009-	OM642.896, OM642.898, OM642.986, OM642.992		EPBBPN3-A011Z	91149	50	310
419 CDI	2.987	140	6	03.2009-	OM642.992, OM642.896, OM642.898	; Position: Air Filter Housing	EPBMPN3-A004Z	90833	10	120
509 CDI	2.148	65	4	06.2006- 12.2009	OM646.984		EPBBPN3-A011Z	91149	50	310
510 CDI	2.143	70	4	03.2009-	OM651.955		EPBMBN3-A003Z	90717	28,9	400
510 CDI	2.143	70	4	03.2009- 05.2016	OM651.955	; Position: Air Filter Housing	EPBMPN3-A004Z	90833	10	120
511 CDI	2.148	80	4	06.2006- 12.2009	OM646.985		EPBBPN3-A011Z	91149	50	310
511 CDI	2.148	80	4	06.2006- 12.2009	OM646.985		EPBBPN3-A011Z	91149	50	310
511 CDI	2.143	84	4	05.2016-	OM651.955		EPBMBN3-V007Z	96602		
513 CDI	2.143	95	4	06.2006- 05.2016	OM651.955	; Position: Air Filter Housing	EPBMPN3-A004Z	90833	10	120
513 CDI	2.148	95	4	06.2006- 05.2016	OM646.986	; Position: Air Filter Housing	EPBMPN3-A004Z	90833	10	120
513 CDI	2.148	95	4	03.2009-	OM646.986		EPBMBN3-A003Z	90717	28,9	400
513 CDI 4x4	2.143	95	4	05.2011- 05.2016	OM651.955, OM651.957		EPBMBN3-A003Z	90717	28,9	400
514 CDI	2.143	105	4	05.2016-	OM651.955		EPBMBN3-V007Z	96602		
514 CDI 4x4	2.143	105	4	05.2016-	OM651.955		EPBMBN3-V007Z	96602		
515 CDI	2.148	110	4	-03.2009	OM646.986, OM646.989, OM646.990		EPBMBN3-A003Z	90717	28,9	400
515 CDI	2.148	110	4	06.2006- 12.2009	OM646.986, OM646.989, OM646.990		EPBBPN3-A002Z	94523	15	260
515 CDI	2.148	110	4	06.2006- 12.2009	OM646.986, OM646.989, OM646.990		EPBBPN3-A011Z	91149	50	310
515 CDI 4x4	2.148	110	4	06.2006- 12.2009	OM646.986, OM646.989, OM646.990		EPBBPN3-A002Z	94523	15	260
515 CDI 4x4	2.148	110	4	06.2006- 12.2009	OM646.986, OM646.989, OM646.990		EPBBPN3-A011Z	91149	50	310
515 CDI 4x4	2.148	110	4	06.2006- 12.2009	OM646.990, OM646.989	; Position: Air Filter Housing	EPBMPN3-A004Z	90833	10	120
516	1.796	115	4	09.2008-	M271.951		EPBBPN3-A002Z	94523	15	260
516 NGT	1.796	115	4	09.2008-	M271.951		EPBBPN3-A002Z	94523	15	260



MERCEDES-BENZ

SPRINTER (906)

516 CDI	2.143	120	4	03.2009-	OM651.957	 ; Position: Air Filter Housing	EPBMPN3-A004Z	90833	10	120
516 CDI	2.143	120	4	03.2009-	OM651.955, OM651.957		EPBMBN3-A003Z	90717	28,9	400
516 CDI 4x4	2.143	120	4	05.2011-	OM651.955, OM651.957		EPBMBN3-A003Z	90717	28,9	400
518 CDI	2.987	135	6	06.2006- 12.2009	OM642.896, OM642.986, OM642.992, OM642.993		EPBBPN3-A011Z	91149	50	310
518 CDI 4x4	2.987	135	6	06.2006- 12.2009	OM642.896, OM642.986, OM642.992, OM642.993		EPBBPN3-A011Z	91149	50	310
518 CDI 4x4	2.987	135	6	06.2006- 12.2009	OM642.992, OM642.993, OM642.896	 ; Position: Air Filter Housing	EPBMPN3-A004Z	90833	10	120
519 CDI / BlueTEC	2.987	140	6	03.2009-	OM642.992, OM642.896, OM642.898	 ; Position: Air Filter Housing	EPBMPN3-A004Z	90833	10	120
519 CDI / BlueTEC	2.987	140	6	03.2009-	OM642.896, OM642.898, OM642.986, OM642.992		EPBBPN3-A011Z	91149	50	310
519 CDI / BlueTEC 4x4	2.987	140	6	03.2009-	OM642.896, OM642.898, OM642.986, OM642.992		EPBBPN3-A011Z	91149	50	310

















SPRINTER (909)

311 CDI	2.148	80	4	09.2013-	OM646.701	 ; Position: Air Filter Housing	EPBMPN3-A004Z	90833	10	120
411 CDI	2.148	80	4	09.2013-	OM646.701	 ; Position: Air Filter Housing	EPBMPN3-A004Z	90833	10	120

VANEO (414)

1.7 CDI	1.689	55	4	02.2002- 07.2005	OM668.914		EPBBPN3-A002Z	94523	15	260
1.7 CDI	1.689	67	4	02.2002- 07.2005	OM668.914		EPBBPN3-A002Z	94523	15	260

VARIO BOX BODY/ESTATE

512 D	2.874	90	5	09.1996- 12.2010	OM602.984		EPBBPN3-A009Z	96930	50	250
612 D	2.874	90	5	09.1996- 12.2010	OM602.984, OM602.985		EPBBPN3-A009Z	96930	50	250
613 D, 614 D	4.250	95	4	09.1996- 12.2013	OM904.908		EPBBPN3-A009Z	96930	50	250
613 D, 614 D	4.250	95	4	09.1996- 12.2013	OM900.917, OM904.908		EPBBPT4-V024Z	92064	40	360
613 D, 614 D	4.250	95	4	09.1996- 12.2013	OM900.917, OM904.908		EPBBPT4-V023Z	94656	50	400
613 D, 614 D	4.250	100	4	09.1996- 12.2011	OM904.908		EPBBPT4-V024Z	92064	40	360
613 D, 614 D	4.250	100	4	09.1996- 12.2011	OM904.908		EPBBPT4-V023Z	94656	50	400
615 D, 616 D	4.250	112	4	09.1998-	OM904.923		EPBBPT4-V024Z	92064	40	360
615 D, 616 D	4.250	112	4	09.1998-	OM904.923		EPBBPT4-V023Z	94656	50	400
615 D, 616 D	4.250	115	4	09.1998-	OM904.923		EPBBPN3-A009Z	96930	50	250
615 D, 616 D	4.250	115	4	09.1998-	OM900.918, OM904.923		EPBBPT4-V024Z	92064	40	360
615 D, 616 D	4.250	115	4	09.1998-	OM900.918, OM904.923		EPBBPT4-V023Z	94656	50	400
618 D	4.249	130	4	09.2006-	OM900.919, OM904.964		EPBBPT4-V024Z	92064	40	360
618 D	4.249	130	4	09.2006-	OM900.919, OM904.964		EPBBPT4-V023Z	94656	50	400
812 D	2.874	90	5	09.1996- 12.2010	OM602.984, OM602.985		EPBBPN3-A009Z	96930	50	250
813 D, 814 D	4.250	95	4	09.1996- 12.2013	OM904.908		EPBBPN3-A009Z	96930	50	250
813 D, 814 D	4.250	95	4	09.1996- 12.2013	OM900.917, OM904.908		EPBBPT4-V024Z	92064	40	360

MAP



l kW C
Y I



Type-N°

Stock-N°

kPa from
kPa to

MERCEDES-BENZ

VARIO BOX BODY/ESTATE

813 D, 814 D	4.250	95	4	09.1996-12.2013	OM900.917, OM904.908		EPBBPT4-V023Z	94656	50	400
813 D, 814 D	4.250	100	4	09.1996-12.2013	OM904.908		EPBBPT4-V024Z	92064	40	360
813 D, 814 D	4.250	100	4	09.1996-12.2013	OM904.908		EPBBPT4-V023Z	94656	50	400
813 DA, 814 DA 4x4	4.250	95	4	09.1996-12.2013	OM904.908		EPBBPN3-A009Z	96930	50	250
813 DA, 814 DA 4x4	4.250	95	4	09.1996-12.2013	OM904.908		EPBBPT4-V024Z	92064	40	360
813 DA, 814 DA 4x4	4.250	95	4	09.1996-12.2013	OM904.908		EPBBPT4-V023Z	94656	50	400
813 DA, 814 DA 4x4	4.250	100	4	09.1996-	OM904.908		EPBBPT4-V024Z	92064	40	360
813 DA, 814 DA 4x4	4.250	100	4	09.1996-	OM904.908		EPBBPT4-V023Z	94656	50	400
815 D, 816 D	4.250	112	4	09.1996-12.2010	OM904.923		EPBBPT4-V024Z	92064	40	360
815 D, 816 D	4.250	112	4	09.1996-12.2010	OM904.923		EPBBPT4-V023Z	94656	50	400
815 D, 816 D	4.250	115	4	09.1996-12.2013	OM904.923		EPBBPN3-A009Z	96930	50	250
815 D, 816 D	4.250	115	4	09.1996-12.2013	OM900.918, OM904.923		EPBBPT4-V024Z	92064	40	360
815 D, 816 D	4.250	115	4	09.1996-12.2013	OM900.918, OM904.923		EPBBPT4-V023Z	94656	50	400
815 DA, 816 DA 4x4	4.250	112	4	09.1996-12.2010	OM904.923		EPBBPT4-V024Z	92064	40	360
815 DA, 816 DA 4x4	4.250	112	4	09.1996-12.2010	OM904.923		EPBBPT4-V023Z	94656	50	400
815 DA, 816 DA 4x4	4.250	115	4	09.1996-12.2013	OM904.923		EPBBPN3-A009Z	96930	50	250
815 DA, 816 DA 4x4	4.250	115	4	09.1996-12.2013	OM904.923		EPBBPT4-V024Z	92064	40	360
815 DA, 816 DA 4x4	4.250	115	4	09.1996-12.2013	OM904.923		EPBBPT4-V023Z	94656	50	400
818 D	4.249	130	4	09.2006-	OM900.919, OM904.964		EPBBPT4-V024Z	92064	40	360
818 D	4.249	130	4	09.2006-	OM900.919, OM904.964		EPBBPT4-V023Z	94656	50	400

VARIO BUS

O 810	4.250	75	4	09.1996-12.2010	OM904.904		EPBBPT4-V024Z	92064	40	360
O 810	4.250	75	4	09.1996-12.2010	OM904.904		EPBBPT4-V023Z	94656	50	400
O 812	2.874	90	5	09.1996-12.2010	OM602.984, OM602.985		EPBBPN3-A009Z	96930	50	250
O 814	4.250	100	4	09.1996-12.2010	OM904.908		EPBBPT4-V024Z	92064	40	360
O 814	4.250	100	4	09.1996-12.2010	OM904.908		EPBBPT4-V023Z	94656	50	400
O 815	4.250	112	4	09.1996-12.2010	OM904.923		EPBBPT4-V024Z	92064	40	360
O 815	4.250	112	4	09.1996-12.2010	OM904.923		EPBBPT4-V023Z	94656	50	400

VARIO CAB WITH ENGINE

810 DT	4.250	75	4	09.1996-12.2010	OM904.904		EPBBPT4-V024Z	92064	40	360
810 DT	4.250	75	4	09.1996-12.2010	OM904.904		EPBBPT4-V023Z	94656	50	400
814 DT	4.250	100	4	09.1996-	OM904.908		EPBBPN3-A009Z	96930	50	250
814 DT	4.250	100	4	09.1996-	OM904.908		EPBBPT4-V024Z	92064	40	360
814 DT	4.250	100	4	09.1996-	OM904.908		EPBBPT4-V023Z	94656	50	400
816 DT	4.250	112	4	09.1996-	OM904.923		EPBBPT4-V024Z	92064	40	360
816 DT	4.250	112	4	09.1996-	OM904.923		EPBBPT4-V023Z	94656	50	400







































Type-N°

Stock-N°

kPa from
kPa to

**MERCEDES-BENZ
VARIO DUMP TRUCK**

612 D	2.874	90	5	09.1996-12.2010	OM602.984, OM602.985		EPBBPN3-A009Z	96930	50	250
613 D, 614 D	4.250	95	4	09.1996-12.2013	OM904.908		EPBBPN3-A009Z	96930	50	250
613 D, 614 D	4.250	95	4	09.1996-12.2013	OM900.917, OM904.908		EPBBPT4-V024Z	92064	40	360
613 D, 614 D	4.250	95	4	09.1996-12.2013	OM900.917, OM904.908		EPBBPT4-V023Z	94656	50	400
613 D, 614 D	4.250	100	4	09.1996-11.2012	OM904.908		EPBBPT4-V024Z	92064	40	360
613 D, 614 D	4.250	100	4	09.1996-11.2012	OM904.908		EPBBPT4-V023Z	94656	50	400
615 D, 616 D	4.250	112	4	09.1998-	OM904.923		EPBBPT4-V024Z	92064	40	360
615 D, 616 D	4.250	112	4	09.1998-	OM904.923		EPBBPT4-V023Z	94656	50	400
615 D, 616 D	4.250	115	4	09.1998-	OM904.923		EPBBPN3-A009Z	96930	50	250
615 D, 616 D	4.250	115	4	09.1998-	OM900.918, OM904.923		EPBBPT4-V024Z	92064	40	360
615 D, 616 D	4.250	115	4	09.1998-	OM900.918, OM904.923		EPBBPT4-V023Z	94656	50	400
618 D	4.249	130	4	09.2006-	OM900.919, OM904.964		EPBBPT4-V024Z	92064	40	360
618 D	4.249	130	4	09.2006-	OM900.919, OM904.964		EPBBPT4-V023Z	94656	50	400
812 D	2.874	90	5	09.1996-12.2010	OM602.984, OM602.985		EPBBPN3-A009Z	96930	50	250
813 D, 814 D	4.250	95	4	09.1996-12.2013	OM904.908		EPBBPN3-A009Z	96930	50	250
813 D, 814 D	4.250	95	4	09.1996-12.2013	OM900.917, OM904.908		EPBBPT4-V024Z	92064	40	360
813 D, 814 D	4.250	95	4	09.1996-12.2013	OM900.917, OM904.908		EPBBPT4-V023Z	94656	50	400
813 D, 814 D	4.250	100	4	09.1996-12.2013	OM904.908		EPBBPT4-V024Z	92064	40	360
813 D, 814 D	4.250	100	4	09.1996-12.2013	OM904.908		EPBBPT4-V023Z	94656	50	400
813 DA, 814 DA 4x4	4.250	95	4	09.1996-12.2013	OM904.908		EPBBPN3-A009Z	96930	50	250
813 DA, 814 DA 4x4	4.250	95	4	09.1996-12.2013	OM904.908		EPBBPT4-V024Z	92064	40	360
813 DA, 814 DA 4x4	4.250	95	4	09.1996-12.2013	OM904.908		EPBBPT4-V023Z	94656	50	400
813 DA, 814 DA 4x4	4.250	100	4	09.1996-12.2013	OM904.908		EPBBPT4-V024Z	92064	40	360
813 DA, 814 DA 4x4	4.250	100	4	09.1996-12.2013	OM904.908		EPBBPT4-V023Z	94656	50	400
815 D, 816 D	4.250	112	4	09.1996-	OM904.923		EPBBPT4-V024Z	92064	40	360
815 D, 816 D	4.250	112	4	09.1996-	OM904.923		EPBBPT4-V023Z	94656	50	400
815 D, 816 D	4.250	115	4	09.1996-12.2013	OM904.923		EPBBPN3-A009Z	96930	50	250
815 D, 816 D	4.250	115	4	09.1996-12.2013	OM900.918, OM904.923		EPBBPT4-V024Z	92064	40	360
815 D, 816 D	4.250	115	4	09.1996-12.2013	OM900.918, OM904.923		EPBBPT4-V023Z	94656	50	400
815 DA, 816 DA 4x4	4.250	112	4	09.1996-12.2010	OM904.923		EPBBPT4-V024Z	92064	40	360
815 DA, 816 DA 4x4	4.250	112	4	09.1996-12.2010	OM904.923		EPBBPT4-V023Z	94656	50	400
815 DA, 816 DA 4x4	4.250	115	4	09.1996-12.2013	OM904.923		EPBBPN3-A009Z	96930	50	250
815 DA, 816 DA 4x4	4.250	115	4	09.1996-12.2013	OM904.923		EPBBPT4-V024Z	92064	40	360
815 DA, 816 DA 4x4	4.250	115	4	09.1996-12.2013	OM904.923		EPBBPT4-V023Z	94656	50	400
818 D	4.249	130	4	09.2006-	OM900.919, OM904.964		EPBBPT4-V024Z	92064	40	360
818 D	4.249	130	4	09.2006-	OM900.919, OM904.964		EPBBPT4-V023Z	94656	50	400

MAP



l kW
C
Y
I



Type-N°

Stock-N°

kPa from
kPa to

MERCEDES-BENZ

VARIO DUMP TRUCK







818 DA 4x4	4.249	130	4	09.2006-	OM904.964		EPBBPT4-V024Z	92064	40	360
818 DA 4x4	4.249	130	4	09.2006-	OM904.964		EPBBPT4-V023Z	94656	50	400

VARIO PLATFORM/CHASSIS







512 D	2.874	90	5	09.1996-12.2010	OM602.984		EPBBPN3-A009Z	96930	50	250
612 D	2.874	90	5	09.1996-12.2010	OM602.984, OM602.985		EPBBPN3-A009Z	96930	50	250
613 D, 614 D	4.250	95	4	09.1996-	OM904.908		EPBBPN3-A009Z	96930	50	250
613 D, 614 D	4.250	95	4	09.1996-	OM904.908, OM904.917		EPBBPT4-V024Z	92064	40	360
613 D, 614 D	4.250	95	4	09.1996-	OM904.908, OM904.917		EPBBPT4-V023Z	94656	50	400
613 D, 614 D	4.250	100	4	09.1996-12.2011	OM904.908		EPBBPT4-V024Z	92064	40	360
613 D, 614 D	4.250	100	4	09.1996-12.2011	OM904.908		EPBBPT4-V023Z	94656	50	400
615 D, 616 D	4.250	112	4	09.1998-	OM904.923		EPBBPT4-V024Z	92064	40	360
615 D, 616 D	4.250	112	4	09.1998-	OM904.923		EPBBPT4-V023Z	94656	50	400
615 D, 616 D	4.250	115	4	09.1998-	OM904.923		EPBBPN3-A009Z	96930	50	250
615 D, 616 D	4.250	115	4	09.1998-	OM900.918, OM904.923		EPBBPT4-V024Z	92064	40	360
615 D, 616 D	4.250	115	4	09.1998-	OM900.918, OM904.923		EPBBPT4-V023Z	94656	50	400
618 D	4.249	130	4	09.2006-	OM900.919, OM904.964		EPBBPT4-V024Z	92064	40	360
618 D	4.249	130	4	09.2006-	OM900.919, OM904.964		EPBBPT4-V023Z	94656	50	400
812 D	2.874	90	5	09.1996-12.2010	OM602.984, OM602.985		EPBBPN3-A009Z	96930	50	250
813 D, 814 D	4.250	95	4	09.1996-12.2013	OM904.908		EPBBPN3-A009Z	96930	50	250
813 D, 814 D	4.250	95	4	09.1996-12.2013	OM900.917, OM904.908		EPBBPT4-V024Z	92064	40	360
813 D, 814 D	4.250	95	4	09.1996-12.2013	OM900.917, OM904.908		EPBBPT4-V023Z	94656	50	400
813 D, 814 D	4.250	100	4	09.1996-12.2013	OM904.908		EPBBPT4-V024Z	92064	40	360
813 D, 814 D	4.250	100	4	09.1996-12.2013	OM904.908		EPBBPT4-V023Z	94656	50	400
813 DA, 814 DA 4x4	4.250	95	4	09.1996-12.2013	OM904.908		EPBBPN3-A009Z	96930	50	250
813 DA, 814 DA 4x4	4.250	95	4	09.1996-12.2013	OM904.908		EPBBPT4-V024Z	92064	40	360
813 DA, 814 DA 4x4	4.250	95	4	09.1996-12.2013	OM904.908		EPBBPT4-V023Z	94656	50	400
813 DA, 814 DA 4x4	4.250	100	4	09.1996-12.2013	OM904.908		EPBBPT4-V024Z	92064	40	360
813 DA, 814 DA 4x4	4.250	100	4	09.1996-12.2013	OM904.908		EPBBPT4-V023Z	94656	50	400
815 D	4.250	110	4	-01.2001	OM904.936	; Engine No. >040488	EPBBPT4-V024Z	92064	40	360
815 D, 816 D	4.250	112	4	09.1996-12.2010	OM904.923		EPBBPT4-V024Z	92064	40	360
815 D, 816 D	4.250	112	4	09.1996-12.2010	OM904.923		EPBBPT4-V023Z	94656	50	400
815 D, 816 D	4.250	115	4	09.1996-12.2013	OM904.923		EPBBPN3-A009Z	96930	50	250
815 D, 816 D	4.250	115	4	09.1996-12.2013	OM900.918, OM904.923		EPBBPT4-V024Z	92064	40	360
815 D, 816 D	4.250	115	4	09.1996-12.2013	OM900.918, OM904.923		EPBBPT4-V023Z	94656	50	400
815 DA, 816 DA 4x4	4.250	112	4	09.1996-12.2010	OM904.923		EPBBPT4-V024Z	92064	40	360
815 DA, 816 DA 4x4	4.250	112	4	09.1996-12.2010	OM904.923		EPBBPT4-V023Z	94656	50	400
815 DA, 816 DA 4x4	4.250	115	4	09.1996-12.2013	OM904.923		EPBBPN3-A009Z	96930	50	250



MERCEDES-BENZ
VARIO PLATFORM/CHASSIS

815 DA, 816 DA 4x4	4.250	115	4	09.1996-12.2013	OM904.923		EPBBPT4-V024Z	92064	40	360
815 DA, 816 DA 4x4	4.250	115	4	09.1996-12.2013	OM904.923		EPBBPT4-V023Z	94656	50	400
818 D	4.249	130	4	09.2006-	OM900.919, OM904.964		EPBBPT4-V024Z	92064	40	360
818 D	4.249	130	4	09.2006-	OM900.919, OM904.964		EPBBPT4-V023Z	94656	50	400
818 DA 4x4	4.249	130	4	09.2006-	OM904.964		EPBBPT4-V024Z	92064	40	360
818 DA 4x4	4.249	130	4	09.2006-	OM904.964		EPBBPT4-V023Z	94656	50	400

V-CLASS (W447)

V 200 CDI / d	2.143	100	4	03.2014-	OM651.950		EPBMBN3-V007Z	96602		
V 200 CDI / d 4-matic	2.143	100	4	04.2015-	OM651.950		EPBMBN3-V007Z	96602		
V 220 CDI / d	2.143	120	4	03.2014-	OM651.950		EPBMBN3-V007Z	96602		
V 220 CDI / d 4-matic	2.143	120	4	03.2015-	OM651.950		EPBMBN3-V007Z	96602		
V 250 BlueTEC / d	2.143	140	4	03.2014-	OM651.950		EPBMBN3-V007Z	96602		
V 250 BlueTEC / d 4-matic	2.143	140	4	12.2014-	OM651.950		EPBMBN3-V007Z	96602		

VIANO (W639)

CDI 2.0	2.148	80	4	-10.2006	OM646.982		EPBBPN3-A002Z	94523	15	260
CDI 2.0	2.148	80	4	09.2003-	OM646.982	 ; Position: Suction Pipe	EPBBPN3-A004Z	90833	10	120
CDI 2.0 4-matic	2.148	80	4	-10.2006	OM646.982		EPBBPN3-A002Z	94523	15	260
CDI 2.0 4-matic	2.148	80	4	07.2005-	OM646.982	 ; Position: Suction Pipe	EPBBPN3-A004Z	90833	10	120
CDI 2.0	2.148	85	4	08.2005-	OM646.982	 ; Position: Suction Pipe	EPBBPN3-A004Z	90833	10	120
CDI 2.0	2.148	85	4	08.2005-	OM646.982		EPBBPN3-A002Z	94523	15	260
CDI 2.0	2.148	85	4	08.2005-	OM646.982		EPBBPN3-A011Z	91149	50	310
CDI 2.0	2.143	100	4	07.2010-	OM651.940	 ; Position: Suction Pipe	EPBBPN3-A004Z	90833	10	120
CDI 2.0	2.143	100	4	07.2010-	OM651.940		EPBMBN3-A003Z	90717	28,9	400
CDI 2.0 4-matic	2.143	100	4	07.2010-	OM651.940	 ; Position: Suction Pipe	EPBBPN3-A004Z	90833	10	120
CDI 2.0 4-matic	2.143	100	4	07.2010-	OM651.940		EPBMBN3-A003Z	90717	28,9	400
CDI 2.2	2.148	110	4	-08.2010	OM646.980, OM646.982		EPBBPN3-A002Z	94523	15	260
CDI 2.2	2.148	110	4	09.2003-	OM646.982	 ; Position: Suction Pipe	EPBBPN3-A004Z	90833	10	120
CDI 2.2	2.148	110	4	09.2003-	OM646.980, OM646.982		EPBBPN3-A011Z	91149	50	310
CDI 2.2 4-matic	2.148	110	4	07.2005-	OM646.982	 ; Position: Suction Pipe	EPBBPN3-A004Z	90833	10	120
CDI 2.2 4-matic	2.148	110	4	07.2005-	OM646.982		EPBBPN3-A002Z	94523	15	260
CDI 2.2 4-matic	2.148	110	4	07.2005-	OM646.982		EPBBPN3-A011Z	91149	50	310
CDI 2.2	2.143	120	4	07.2010-	OM651.940	 ; Position: Suction Pipe	EPBBPN3-A004Z	90833	10	120
CDI 2.2	2.143	120	4	07.2010-	OM651.940		EPBMBN3-A003Z	90717	28,9	400
CDI 2.2 4-matic	2.143	120	4	07.2010-	OM651.940	 ; Position: Suction Pipe	EPBBPN3-A004Z	90833	10	120
CDI 2.2 4-matic	2.143	120	4	07.2010-	OM651.940		EPBMBN3-A003Z	90717	28,9	400
CDI 3.0	2.987	150	6	03.2006-	OM642.990	 ; Position: Air Filter Housing	EPBBPN3-A004Z	90833	10	120
CDI 3.0	2.987	150	6	03.2006-	OM642.990		EPBBPN3-A011Z	91149	50	310

MAP



l kW
C
Y
I



Type-N°

Stock-N°

kPa from

kPa to

MERCEDES-BENZ

VIANO (W639)

CDI 3.0	2.987	165	6	07.2010-	OM642.890		EPBBPN3-A011Z	91149	50	310
---------	-------	-----	---	----------	-----------	--	---------------	-------	----	-----

VITO (W447)

114 CDI	2.143	100	4	10.2014-	OM651.950		EPBMBN3-V007Z	96602		
114 CDI / 114 BlueTEC 4-matic	2.143	100	4	07.2015-	OM651.950		EPBMBN3-V007Z	96602		
114 CDI 4-matic	2.143	100	4	07.2015-	OM651.950		EPBMBN3-V007Z	96602		
114 CDI 4x4	2.143	100	4	07.2015-	OM651.950		EPBMBN3-V007Z	96602		
116 CDI	2.143	120	4	10.2014-	OM651.950		EPBMBN3-V007Z	96602		
116 CDI / 116 BlueTEC	2.143	120	4	10.2014-	OM651.950		EPBMBN3-V007Z	96602		
116 CDI / 116 BlueTEC 4-matic	2.143	120	4	07.2015-	OM651.950		EPBMBN3-V007Z	96602		
116 CDI 4-matic	2.143	120	4	07.2015-	OM651.950		EPBMBN3-V007Z	96602		
116 CDI 4x4	2.143	120	4	07.2015-	OM651.950		EPBMBN3-V007Z	96602		
119 BlueTEC	2.143	140	4	10.2014-	OM651.950		EPBMBN3-V007Z	96602		
119 BlueTEC 4-matic	2.143	140	4	12.2014-	OM651.950		EPBMBN3-V007Z	96602		
119 CDI / 119 BlueTEC	2.143	140	4	10.2014-	OM651.950		EPBMBN3-V007Z	96602		
119 CDI / 119 BlueTEC 4-matic	2.143	140	4	12.2014-	OM651.950		EPBMBN3-V007Z	96602		
119 CDI / BlueTEC	2.143	140	4	10.2014-	OM651.950		EPBMBN3-V007Z	96602		
119 CDI / BlueTEC 4x4	2.143	140	4	07.2015-	OM651.950		EPBMBN3-V007Z	96602		

VITO (W639)

109 CDI	2.148	65	4	-10.2006	OM646.983		EPBBPN3-A002Z	94523	15	260
109 CDI	2.148	65	4	09.2003-	OM646.983	; Position: Suction Pipe	EPBMPN3-A004Z	90833	10	120
109 CDI	2.148	70	4	08.2006-	OM646.980	; Position: Suction Pipe	EPBMPN3-A004Z	90833	10	120
109 CDI	2.148	70	4	08.2006-	OM646.980, OM646.981		EPBBPN3-A011Z	91149	50	310
109 CDI 4x4	2.148	70	4	09.2007-	OM646.981		EPBBPN3-A011Z	91149	50	310
110 CDI	2.143	70	4	09.2010-	OM651.940	; Position: Suction Pipe	EPBMPN3-A004Z	90833	10	120
110 CDI	2.143	70	4	09.2010-	OM651.940		EPBMBN3-A003Z	90717	28,9	400
111 CDI	2.148	80	4	-10.2006	OM646.982		EPBBPN3-A002Z	94523	15	260
111 CDI	2.148	80	4	09.2003-	OM646.982	; Position: Suction Pipe	EPBMPN3-A004Z	90833	10	120
111 CDI 4x4	2.148	80	4	09.2007-	OM646.982	; Position: Suction Pipe	EPBMPN3-A004Z	90833	10	120
111 CDI 4x4	2.148	80	4	09.2007-	OM646.982		EPBBPN3-A002Z	94523	15	260
111 CDI 4x4	2.148	80	4	09.2007-	OM646.982		EPBBPN3-A011Z	91149	50	310
111 CDI	2.148	85	4	09.2007-	OM646.980, OM646.982		EPBBPN3-A002Z	94523	15	260
111 CDI	2.148	85	4	09.2007-	OM646.980, OM646.982		EPBBPN3-A011Z	91149	50	310
111 CDI	2.148	85	4	09.2007-	OM646.982, OM646.980	; Position: Suction Pipe	EPBMPN3-A004Z	90833	10	120
113 CDI	2.143	100	4	09.2010-	OM651.940	; Position: Suction Pipe	EPBMPN3-A004Z	90833	10	120
113 CDI	2.143	100	4	09.2010-	OM651.940		EPBMBN3-A003Z	90717	28,9	400
113 CDI 4x4	2.143	100	4	09.2010-	OM651.940	; Position: Suction Pipe	EPBMPN3-A004Z	90833	10	120
113 CDI 4x4	2.143	100	4	09.2010-	OM651.940		EPBMBN3-A003Z	90717	28,9	400





MERCEDES-BENZ

VITO (W639)





115 CDI	2.148	110	4	-07.2010	OM646.980, OM646.982		EPBBPN3-A002Z	94523	15	260
115 CDI	2.148	110	4	09.2003-	OM646.982	 ; Position: Suction Pipe	EPBMPN3-A004Z	90833	10	120
115 CDI 4x4	2.148	110	4	-07.2010	OM646.982		EPBBPN3-A002Z	94523	15	260
115 CDI 4x4	2.148	110	4	07.2006-	OM646.982	 ; Position: Suction Pipe	EPBMPN3-A004Z	90833	10	120
116 CDI 4x4	2.143	120	4	09.2010-	OM651.940	 ; Position: Suction Pipe	EPBMPN3-A004Z	90833	10	120
116 CDI	2.143	120	4	09.2010-	OM651.940	 ; Position: Suction Pipe	EPBMPN3-A004Z	90833	10	120
116 CDI	2.143	120	4	09.2010-	OM651.940		EPBMBN3-A003Z	90717	28,9	400
116 CDI 4x4	2.143	120	4	09.2010-	OM651.940		EPBMBN3-A003Z	90717	28,9	400
119	3.199	140	6	09.2003-	M112.951	 ; Position: Intake Manifold	EPBMPN3-A004Z	90833	10	120
120 CDI	2.987	150	6	07.2006-	OM642.990	 ; Position: Air Filter Housing	EPBMPN3-A004Z	90833	10	120
120 CDI	2.987	150	6	07.2006-	OM642.990		EPBBPN3-A011Z	91149	50	310
122	3.199	160	6	09.2003-	M112.951	 ; Position: Intake Manifold	EPBMPN3-A004Z	90833	10	120
122 CDI	2.987	165	6	09.2010-	OM642.890	 ; Position: Air Filter Housing	EPBMPN3-A004Z	90833	10	120
122 CDI	2.987	165	6	09.2010-	OM642.890		EPBBPN3-A011Z	91149	50	310
123	3.724	165	6	06.2004-07.2008	M112.976	 ; Position: Intake Manifold	EPBMPN3-A004Z	90833	10	120
123	3.724	170	6	06.2004-07.2008	M112.976	 ; Position: Intake Manifold	EPBMPN3-A004Z	90833	10	120

MG



EXPRESS BOX

1.4	1.396	76	4	03.2003-05.2005	14 K4F		EPBMPT4-V009Z	96309	10	117
1.8	1.796	86	4	03.2003-05.2005	18 K4F		EPBMPT4-V009Z	96309	10	117
160	1.796	118	4	03.2003-05.2005	18 K4K		EPBMPT4-V009Z	96309	10	117





MG TF

115	1.588	85	4	03.2002-12.2009	16 K4F		EPBMPT4-V009Z	96309	10	117
120	1.796	88	4	03.2002-12.2009	18 K4F		EPBMPT4-V009Z	96309	10	117
135	1.796	100	4	03.2002-12.2009	18 K4F		EPBMPT4-V009Z	96309	10	117
160	1.796	118	4	03.2002-12.2009	18 K4K		EPBMPT4-V009Z	96309	10	117

MG ZR

105	1.396	76	4	06.2001-04.2005	14 K4F		EPBMPT4-V009Z	96309	10	117
120	1.796	86	4	06.2001-04.2005	18 K4F		EPBMPT4-V009Z	96309	10	117
160	1.796	118	4	06.2001-04.2005	18 K4K	 ; Chass. >471565	EPBMPT4-V009Z	96309	10	117

MG ZS

1.6	1.588	79	4	07.2003-04.2005	16 K4F		EPBMPT4-V009Z	96309	10	117
120	1.796	86	4	07.2001-10.2005	18 K4F		EPBMPT4-V009Z	96309	10	117
2.0 TD	1.994	74	4	01.2004-10.2005	20 T2N		EPBBPN3-A028Z	93277	20	200
180	2.497	130	6	07.2001-10.2005	25 K4F		EPBMPT4-V009Z	96309	10	117

MG ZT / ZT-T

1.8 16V	1.795	88	4	01.2003-07.2005	18 K4F		EPBMPT4-V009Z	96309	10	117
1.8 T 16V	1.795	118	4	01.2003-07.2005	18 K4G		EPBMPT4-V009Z	96309	10	117

MAP



l kW
C
Y
I



Type-N°

Stock-N°

kPa from
kPa to

MG

MG ZT / ZT-T

160	2.497	118	6	06.2001-07.2005	25 K4F		EPBMPT4-V009Z	96309	10	117
180	2.497	130	6	02.2004-10.2005	25 K4F		EPBMPT4-V009Z	96309	10	117
190	2.497	140	6	06.2001-07.2005	25 K4F		EPBMPT4-V009Z	96309	10	117

MGF (RD)

1.6	1.588	82	4	02.2000-03.2002	16 K4F		EPBMPT4-V009Z	96309	10	117
1.8 i 16V	1.796	88	4	03.1995-03.2002	18 K4F		EPBMPT4-V009Z	96309	10	117
1.8 i VVC	1.796	107	4	03.1995-03.2002	18 K4K	; Chass. >522573	EPBMPT4-V009Z	96309	10	117
1.8 i VVC	1.796	118	4	10.2001-03.2002	18 K4K	; Chass. >522573	EPBMPT4-V009Z	96309	10	117

MINI

MINI (F55, F56, F57)

One D	1.496	70	3	02.2014-	B37C15A		EPBMBN3-V002Z	94886	27,2	400
Cooper D	1.496	85	3	10.2013-	B37C15A		EPBMBN3-V002Z	94886	27,2	400
Cooper SD	1.995	120	4	09.2013-	B47C20A, B47C20B		EPBMBN3-V002Z	94886	27,2	400
Cooper SD	1.995	125	4	09.2013-	B47C20A, B47C20B		EPBMBN3-V002Z	94886	27,2	400

MINI (R50, R52, R53)

One	1.398	55	4	04.2003-09.2006	W10B14A		EPBMPT4-V009Z	96309	10	117
One	1.598	66	4	06.2001-11.2007	W10B16A		EPBMPT4-V009Z	96309	10	117
Cooper	1.598	85	4	06.2001-07.2008	W10B16A		EPBMPT4-V009Z	96309	10	117
Cooper S	1.598	120	4	03.2002-11.2007	W11B16A		EPBBPT4-V008Z	92801	15	245
Cooper S	1.598	125	4	07.2004-11.2007	W11B16A		EPBBPT4-V008Z	92801	15	245
S Works	1.598	149	4	11.2003-06.2005	W11B16A		EPBBPT4-V008Z	92801	15	245
John Cooper Works	1.598	155	4	11.2003-11.2007	W11B16A		EPBBPT4-V008Z	92801	15	245
John Cooper Works	1.598	160	4	03.2006-09.2006	W11B16A		EPBBPT4-V008Z	92801	15	245

MINI (R56, R57)

One	1.397	55	4	03.2009-03.2010	N12B14A		EPBMPT4-A006Z	96115		
One	1.397	70	4	11.2006-03.2010	N12B14A		EPBMPT4-A006Z	96115		
One D	1.560	66	4	06.2009-07.2010	9HZ(DV6TED4)	; Position: Throttle Housing	EPBBPN3-A001Z	94263	10	240
One D	1.598	66	4	07.2010-11.2013	N47C16A		EPBMBN3-V002Z	94886	27,2	400
Cooper D	1.560	80	4	11.2006-09.2010	9HZ(DV6TED4), W16D16(9HZ)		EPBBPN3-A001Z	94263	10	240
Cooper D	1.598	82	4	05.2009-11.2013	N47C16A		EPBMBN3-V002Z	94886	27,2	400
Cooper	1.598	88	4	10.2006-02.2012	N12B16A, N16B16A		EPBMPT4-A006Z	96115		
Cooper S	1.598	120	4	03.2010-	N14B16A, N18B16A		EPBBPN3-V030Z	94092	50	465
Cooper S	1.598	128	4	04.2008-07.2010	N14B16A	; Position: Intake Manifold	EPBBPN3-A024Z	91449	50	350
Cooper S	1.598	128	4	04.2008-07.2010	N14B16AB		EPBBPN3-A024Z	91449	50	350
Cooper S	1.598	135	4	02.2010-06.2015	N18B16A		EPBBPN3-V030Z	94092	50	465
Cooper S John Cooper Works	1.598	141	4	11.2006-02.2010	N14B16A, N14B16AB		EPBBPN3-A024Z	91449	50	350
Cooper S	1.598	147	4	02.2010-06.2015	N18B16A		EPBBPN3-V030Z	94092	50	465



MAP



l kW
C
Y
I



Type-N°

Stock-N°

kPa from

kPa to

MINI

MINI (R56, R57)

John Cooper Works	1.598	155	4	11.2007-05.2015	N14B16C, N18B16C		EPBMPN3-A044Z	93056		
Cooper D	1.995	82	4	02.2011-05.2015	N47C20A		EPBMBN3-V002Z	94886	27,2	400
Cooper SD	1.995	100	4	01.2011-05.2015	N47C20A		EPBMBN3-V002Z	94886	27,2	400
Cooper SD	1.995	105	4	06.2009-05.2015	N47C20A		EPBMBN3-V002Z	94886	27,2	400

MINI CLUBMAN (F54)

One D	1.496	85	3	02.2015-	B37C15A		EPBMBN3-V002Z	94886	27,2	400
Cooper D	1.995	100	4	12.2014-	B47C20A, B47C20B		EPBMBN3-V002Z	94886	27,2	400
Cooper D	1.995	110	4	12.2014-	B47C20A, B47C20B		EPBMBN3-V002Z	94886	27,2	400
Cooper SD	1.995	120	4	02.2015-	B47C20A, B47C20B		EPBMBN3-V002Z	94886	27,2	400
Cooper SD ALL4	1.995	120	4	04.2015-	B47C20A, B47C20B		EPBMBN3-V002Z	94886	27,2	400
Cooper SD	1.995	140	4	02.2015-	B47C20A, B47C20B		EPBMBN3-V002Z	94886	27,2	400
Cooper SD ALL4	1.995	140	4	04.2015-	B47C20A, B47C20B		EPBMBN3-V002Z	94886	27,2	400

MINI CLUBMAN (R55)

One D	1.598	66	4	03.2010-06.2014	N47C16A		EPBMBN3-V002Z	94886	27,2	400
Cooper D	1.560	80	4	10.2007-02.2010	9HZ(DV6TED4)	; Position: Throttle Housing	EPBBPN3-A001Z	94263	10	240
Cooper D	1.598	82	4	03.2010-06.2014	N47C16A		EPBMBN3-V002Z	94886	27,2	400
Cooper	1.598	88	4	10.2007-12.2013	N12B16A, N16B16A		EPBMPT4-A006Z	96115		
Cooper S	1.598	120	4	10.2007-06.2014	N14B16A, N14B16A		EPBBPN3-A024Z	91449	50	350
Cooper S	1.598	128	4	08.2007-07.2010	N14B16A, N14B16AB		EPBBPN3-A024Z	91449	50	350
Cooper S	1.598	135	4	03.2010-06.2014	N18B16A		EPBBPN3-V030Z	94092	50	465
Cooper S John Cooper Works	1.598	141	4	10.2008-02.2010	N14B16AB		EPBBPN3-A024Z	91449	50	350
Cooper S	1.598	147	4	03.2010-06.2014	N18B16A		EPBBPN3-V030Z	94092	50	465
John Cooper Works	1.598	155	4	11.2007-06.2014	N14B16C, N18B16C		EPBMPN3-A044Z	93056		
Cooper D	1.995	82	4	02.2011-06.2014	N47C20A		EPBMBN3-V002Z	94886	27,2	400
Cooper SD	1.995	100	4	02.2011-06.2014	N47C20A		EPBMBN3-V002Z	94886	27,2	400
Cooper SD	1.995	105	4	02.2011-06.2014	N47C20A		EPBMBN3-V002Z	94886	27,2	400

MINI COUNTRYMAN (F60)

One D	1.496	85	3	07.2017-	B37C15A		EPBMBN3-V002Z	94886	27,2	400
Cooper D	1.995	100	4	10.2016-	B47C20A		EPBMBN3-V002Z	94886	27,2	400
Cooper D ALL4	1.995	100	4	10.2016-	B47C20A		EPBMBN3-V002Z	94886	27,2	400
Cooper D	1.995	110	4	10.2016-	B47C20A		EPBMBN3-V002Z	94886	27,2	400
Cooper D ALL4	1.995	110	4	10.2016-	B47C20A		EPBMBN3-V002Z	94886	27,2	400
Cooper SD	1.995	120	4	10.2016-	B47C20A		EPBMBN3-V002Z	94886	27,2	400
Cooper SD ALL4	1.995	120	4	10.2016-	B47C20A		EPBMBN3-V002Z	94886	27,2	400
Cooper SD	1.995	140	4	10.2016-	B47C20A		EPBMBN3-V002Z	94886	27,2	400
Cooper SD ALL4	1.995	140	4	10.2016-	B47C20A		EPBMBN3-V002Z	94886	27,2	400

MINI COUNTRYMAN (R60)

One D	1.598	66	4	08.2010-10.2016	N47C16A		EPBMBN3-V002Z	94886	27,2	400
-------	-------	----	---	-----------------	---------	--	---------------	-------	------	-----



MAP



l kW
C
Y
I



Type-N°

Stock-N°

kPa from

kPa to

MINI

MINI COUNTRYMAN (R60)

Cooper D	1.598	82	4	08.2010-10.2016	N47C16A		EPBMBN3-V002Z	94886	27,2	400
Cooper D ALL4	1.598	82	4	08.2010-10.2016	N47C16A		EPBMBN3-V002Z	94886	27,2	400
Cooper ALL4	1.598	90	4	11.2012-10.2016	N18B16A		EPBBPN3-V030Z	94092	50	465
Cooper S ALL4	1.598	120	4	08.2010-10.2016	N18B16A		EPBBPN3-V030Z	94092	50	465
Cooper S	1.598	135	4	08.2010-10.2016	N18B16A		EPBBPN3-V030Z	94092	50	465
Cooper S ALL4	1.598	135	4	08.2010-10.2016	N18B16A		EPBBPN3-V030Z	94092	50	465
Cooper S	1.598	140	4	07.2014-10.2016	N18B16A		EPBBPN3-V030Z	94092	50	465
Cooper S ALL4	1.598	140	4	07.2014-10.2016	N18B16A		EPBBPN3-V030Z	94092	50	465
Cooper S	1.598	147	4	08.2010-10.2016	N18B16A		EPBBPN3-V030Z	94092	50	465
Cooper D	1.995	82	4	03.2011-10.2016	N47C20A		EPBMBN3-V002Z	94886	27,2	400
Cooper D ALL4	1.995	82	4	03.2011-10.2016	N47C20A		EPBMBN3-V002Z	94886	27,2	400
Cooper SD	1.995	100	4	03.2011-10.2016	N47C20A		EPBMBN3-V002Z	94886	27,2	400
Cooper SD ALL4	1.995	100	4	03.2011-10.2016	N47C20A		EPBMBN3-V002Z	94886	27,2	400
Cooper SD	1.995	105	4	03.2011-10.2016	N47C20A		EPBMBN3-V002Z	94886	27,2	400
Cooper SD ALL4	1.995	105	4	03.2011-10.2016	N47C20A		EPBMBN3-V002Z	94886	27,2	400

MINI COUPE (R58)

Cooper S	1.598	120	4	12.2010-04.2015	N18B16A		EPBBPN3-V030Z	94092	50	465
Cooper S	1.598	135	4	12.2010-04.2015	N14B16A, N18B16A		EPBBPN3-V030Z	94092	50	465
Cooper S JCW	1.598	147	4	12.2010-04.2015	N18B16A		EPBBPN3-V030Z	94092	50	465
Cooper SD	1.995	100	4	12.2010-05.2015	N47C20A		EPBMBN3-V002Z	94886	27,2	400
Cooper SD	1.995	105	4	12.2010-05.2015	N47C20A		EPBMBN3-V002Z	94886	27,2	400

MINI PACEMAN (R61)

Cooper D	1.598	82	4	04.2012-09.2016	N47C16A		EPBMBN3-V002Z	94886	27,2	400
Cooper D ALL4	1.598	82	4	04.2012-09.2016	N47C16A		EPBMBN3-V002Z	94886	27,2	400
Cooper ALL4	1.598	90	4	11.2012-09.2016	N18B16A		EPBBPN3-V030Z	94092	50	465
Cooper S ALL4	1.598	120	4	07.2014-	N18B16A		EPBBPN3-V030Z	94092	50	465
Cooper S	1.598	135	4	11.2012-10.2016	N18B16A		EPBBPN3-V030Z	94092	50	465
Cooper S ALL4	1.598	135	4	03.2012-09.2016	N18B16A		EPBBPN3-V030Z	94092	50	465
Cooper S	1.598	140	4	07.2014-09.2016	N18B16A		EPBBPN3-V030Z	94092	50	465
Cooper S ALL4	1.598	140	4	03.2012-09.2016	N18B16A		EPBBPN3-V030Z	94092	50	465
Cooper D	1.995	82	4	07.2012-09.2016	N47C20A		EPBMBN3-V002Z	94886	27,2	400
Cooper D ALL4	1.995	82	4	03.2012-09.2016	N47C20A		EPBMBN3-V002Z	94886	27,2	400
Cooper SD ALL4	1.995	100	4	04.2012-09.2016	N47C20A		EPBMBN3-V002Z	94886	27,2	400
Cooper SD	1.995	105	4	03.2012-09.2016	N47C20A		EPBMBN3-V002Z	94886	27,2	400
Cooper SD ALL4	1.995	105	4	04.2012-09.2016	N47C20A		EPBMBN3-V002Z	94886	27,2	400

MINI ROADSTER (R59)

Cooper S	1.598	120	4	11.2011-04.2015	N18B16A		EPBBPN3-V030Z	94092	50	465
----------	-------	-----	---	-----------------	---------	--	---------------	-------	----	-----



MAP



l kW C Y I



Type-N°

Stock-N°

kPa from

kPa to

MINI

MINI ROADSTER (R59)

Cooper S	1.598	135	4	11.2011-04.2015	N18B16A		EPBBPN3-V030Z	94092	50	465
Cooper S JCW	1.598	147	4	11.2011-04.2015	N18B16A		EPBBPN3-V030Z	94092	50	465
Cooper SD	1.995	100	4	11.2011-04.2015	N47C20A		EPBMBN3-V002Z	94886	27,2	400
Cooper SD	1.995	105	4	11.2011-04.2015	N47C20A		EPBMBN3-V002Z	94886	27,2	400

MITSUBISHI

COLT CZC CONVERTIBLE (RG)

1.5	1.499	80	4	05.2006-07.2009	4A91		EPBMPT4-V010Z	96347	10	115
-----	-------	----	---	-----------------	------	--	---------------	-------	----	-----

COLT VI (Z3_A, Z2_A)

1.1	1.124	55	3	10.2004-06.2012	3A91		EPBMPT4-V010Z	96347	10	115
1.3	1.332	70	4	06.2004-06.2012	4A90		EPBMPT4-V010Z	96347	10	115
1.5	1.499	80	4	06.2004-06.2012	4A91		EPBMPT4-V010Z	96347	10	115

GRANDIS (NA_W)

2.0 DI-D	1.968	100	4	09.2005-03.2010	BSY		EPBBPT4-V002Z	95912	20	300
2.0 DI-D	1.968	103	4	02.2007-03.2010	BWC		EPBBPT4-V002Z	95912	20	300

LANCER VIII (CY_A, CZ_A, CX_A)

1.5 Bifuel	1.499	80	4	-06.2010	4A91		EPBMPT4-V010Z	96347	10	115
1.5	1.499	80	4	06.2008-	4A91		EPBMPT4-V010Z	96347	10	115
2.0 DI-D	1.968	103	4	01.2008-	BKD		EPBBPT4-V002Z	95912	20	300

OUTLANDER II (CW_W)

2.0 DI-D	1.968	103	4	02.2007-11.2012	BSY		EPBBPT4-V002Z	95912	20	300
2.2 DI-D 4WD	2.179	115	4	08.2007-11.2012	4HN, 4HK		EPBBPN3-A018Z	95753	35	320

SPACE STAR MPV (DG_A)

1.9 DI-D	1.870	75	4	02.2001-12.2004	F9Q1	; OE M-889795	EPBMPN3-V013Z	94788	15	255
1.9 DI-D	1.870	85	4	10.2002-12.2004	F9Q2	; OE M-889795	EPBMPN3-V013Z	94788	15	255

NISSAN

370 Z (Z34)

3.7	3.696	241	6	06.2009-	VQ37VHR		EPBMPN3-A050Z	96018		
3.7	3.696	243	6	12.2009-	VQ37VHR		EPBMPN3-A050Z	96018		
3.7	3.696	248	6	04.2009-	VQ37VHR		EPBMPN3-A050Z	96018		
NISMO 3.7	3.696	253	6	06.2013-	VQ37VHR		EPBMPN3-A050Z	96018		

ALMERA II (N16)

1.5 dCi	1.461	60	4	01.2003-09.2006	K9K722		EPBMPN3-V001Z	90037	20	100
---------	-------	----	---	-----------------	--------	--	---------------	-------	----	-----

CABSTAR (F24M, F24W)

28.11 DCI, 32.11 DCI, 35.11 DCI 2.5	2.488	81	4	10.2011-	YD25DDTi		EPBMPN3-A047Z	90252		
28.12 DCI, 32.12 DCI, 34.12 DCI, 35.12 DCI 2.5	2.488	90	4	10.2011-	YD25DDTi		EPBMPN3-A047Z	90252		
35.13 DCI, 45.13 DCI 2.5	2.488	96	4	10.2011-	YD25DDTi		EPBMPN3-A047Z	90252		
35.14 DCI, 45.14 DCI 2.5	2.488	100	4	10.2011-	YD25DDTi, YD25K3LD-5MI		EPBMPN3-A047Z	90252		

CUBE (Z12)

1.5 dCi	1.461	78	4	03.2010-	K9K, K9K270		EPBBPN3-V007Z	97073	20	300
---------	-------	----	---	----------	-------------	--	---------------	-------	----	-----



MAP



l kW
C
Y
I



Type-N°

Stock-N°

kPa from

kPa to

NISSAN

CUBE (Z12)

1.5 dCi	1.461	81	4	03.2010-	K9K, K9K270		EPBBPN3-V007Z	97073	20	300
---------	-------	----	---	----------	-------------	--	---------------	-------	----	-----

GT-R (R35)

V6	3.799	357	6	12.2007-10.2010	VR38DETT		EPBMPN3-A050Z	96018		
V6	3.799	357	6	12.2007-10.2010	VR38DETT		EPBMPN3-A047Z	90252		
V6	3.799	390	6	10.2010-09.2011	VR38DETT		EPBMPN3-A050Z	96018		
V6	3.799	390	6	10.2010-09.2011	VR38DETT		EPBMPN3-A047Z	90252		
V6	3.799	404	6	10.2011-	VR38DETT		EPBMPN3-A050Z	96018		
V6	3.799	404	6	10.2011-	VR38DETT		EPBMPN3-A047Z	90252		
V6	3.799	419	6	06.2016-	VR38DETT		EPBMPN3-A047Z	90252		
NISMO	3.799	441	6	07.2014-	VR38DETT		EPBMPN3-A047Z	90252		

INTERSTAR (X70)

dCi 80	1.870	60	4	-12.2002	F9Q772, F9Q774		EPBBPN3-V008Z	90842	20	250
dCi 80	1.870	60	4	01.2003-	F9Q772, F9Q774		EPBBPN3-V014Z	96895	20	250
dCi 90	2.188	66	4	07.2002-	G9T722		EPBMPN3-V001Z	90037	20	100
dCi 100	2.464	73	4	11.2003-	G9U720, G9U754		EPBBPN3-V007Z	97073	20	300
dCi 100	2.464	74	4	04.2006-	G9U650, G9U720, G9U754		EPBBPN3-V007Z	97073	20	300
dCi 120	2.464	84	4	04.2002-	G9U720, G9U724, G9U750		EPBBPN3-V007Z	97073	20	300
dCi 120	2.464	88	4	08.2006-	G9U650		EPBBPN3-V007Z	97073	20	300
dCi 150	2.464	107	4	09.2006-	G9U632		EPBBPN3-V007Z	97073	20	300

JUKE (F15)

1.2 DIG-T	1.197	85	4	05.2014-	HRA2DDT		EPBMPN3-A048Z	94778		
1.5 dCi	1.461	81	4	06.2010-	K9K410, K9K636, K9K646, K9K896		EPBBPN3-V007Z	97073	20	300
1.6 DIG-T 4x4	1.618	140	4	05.2014-	MR16DDT	;	EPBMPN3-A047Z	90252		
1.6 DIG-T	1.618	140	4	05.2014-	MR16DDT	;	EPBMPN3-A047Z	90252		
1.6 DIG-T 4x4	1.618	140	4	06.2010-	MR16DDT	;	EPBMPN3-A049Z	93927		
1.6 DIG-T 4x4	1.618	140	4	06.2010-	MR16DDT	; Position: Throttle Housing	EPBMPT4-A046Z	92256		
1.6 DIG-T	1.618	140	4	06.2010-	MR16DDT	;	EPBMPN3-A049Z	93927		
1.6 DIG-T	1.618	140	4	06.2010-	MR16DDT	; Position: Throttle Housing	EPBMPT4-A046Z	92256		
1.6 DIG-T NISMO 4x4	1.618	147	4	02.2013-07.2014	MR16DDT	;	EPBMPN3-A049Z	93927		
1.6 DIG-T NISMO 4x4	1.618	147	4	02.2013-07.2014	MR16DDT	; Position: Throttle Housing	EPBMPT4-A046Z	92256		
1.6 DIG-T NISMO	1.618	147	4	03.2013-07.2014	MR16DDT	;	EPBMPN3-A049Z	93927		
1.6 DIG-T NISMO	1.618	147	4	03.2013-07.2014	MR16DDT	; Position: Throttle Housing	EPBMPT4-A046Z	92256		
1.6 DIG-T NISMO 4x4	1.618	147	4	05.2014-	MR16DDT	;	EPBMPN3-A047Z	90252		
1.6 DIG-T NISMO	1.618	147	4	05.2014-	MR16DDT	;	EPBMPN3-A047Z	90252		
1.6 DIG-T NISMO RS 4x4	1.618	157	4	08.2014-	MR16DDT	;	EPBMPN3-A049Z	93927		
1.6 DIG-T NISMO RS 4x4	1.618	157	4	08.2014-	MR16DDT	; Position: Throttle Housing	EPBMPT4-A046Z	92256		
1.6 DIG-T NISMO RS 4x4	1.618	157	4	08.2014-	MR16DDT	;	EPBMPN3-A047Z	90252		



MAP



l kW C
Y I



Type-N°

Stock-N°

kPa from

kPa to

NISSAN

JUKE (F15)

1.6 DIG-T NISMO RS	1.618	160	4	08.2014-	MR16DDT	;	EPBMPN3-A049Z	93927		
1.6 DIG-T NISMO RS	1.618	160	4	08.2014-	MR16DDT	; Position: Throttle Housing	EPBMPT4-A046Z	92256		
1.6 DIG-T NISMO RS	1.618	160	4	08.2014-	MR16DDT	; Great Britain	EPBMPN3-A047Z	90252		

KUBISTAR BOX (X76)

1.2	1.149	44	4	08.2003-	D7F764		EPBMPN3-V001Z	90037	20	100
1.2 16V	1.149	55	4	04.2006-	D4F712		EPBMPN3-V001Z	90037	20	100
1.6 16V	1.598	70	4	08.2003-	K4M752		EPBMPN3-V001Z	90037	20	100

MICRA III (K12)

1.0 16V	998	48	4	01.2003-06.2010	CG10DE		EPBMPN3-V001Z	90037	20	100
1.0 16V	998	48	4	01.2003-06.2010	CG10DE		EPBMPT4-V016Z	92071	10	110
1.2 16V	1.240	48	4	01.2003-06.2010	CG12DE, CR12DE		EPBMPN3-V001Z	90037	20	100
1.2 16V	1.240	48	4	01.2003-06.2010	CR12DE, CG12DE		EPBMPT4-V016Z	92071	10	110
1.2 16V	1.240	59	4	01.2003-06.2010	CG12DE, CR12DE		EPBMPN3-V001Z	90037	20	100
1.2 16V	1.240	59	4	01.2003-06.2010	CR12DE, CG12DE		EPBMPT4-V016Z	92071	10	110
1.2 LPG	1.240	59	4	10.2002-06.2010	CR12DE		EPBMPT4-V016Z	92071	10	110
1.4 16V	1.386	65	4	01.2003-06.2010	CR14DE		EPBMPT4-V016Z	92071	10	110
1.4 16V	1.386	65	4	01.2003-06.2010	CR14DE		EPBMPN3-V001Z	90037	20	100
1.5 dCi	1.461	48	4	01.2003-06.2010	K9K704		EPBMPN3-V001Z	90037	20	100
1.5 dCi	1.461	48	4	01.2003-06.2010	K9K704		EPBBPN3-V007Z	97073	20	300
1.5 dCi	1.461	50	4	06.2005-06.2010	K9K708		EPBMPN3-V001Z	90037	20	100
1.5 dCi	1.461	50	4	06.2005-06.2010	K9K708		EPBBPN3-V007Z	97073	20	300
1.5 dCi	1.461	60	4	10.2005-	K9K722		EPBBPN3-V007Z	97073	20	300
1.5 dCi	1.461	63	4	06.2005-06.2010	K9K276		EPBBPN3-V007Z	97073	20	300
160 SR	1.598	81	4	05.2005-06.2010	HR16DE		EPBMPN3-V001Z	90037	20	100

MICRA IV (K13_)

1.2	1.198	59	3	03.2011-	HR12DE		EPBMPN3-A050Z	96018		
-----	-------	----	---	----------	--------	--	---------------	-------	--	--

MURANO II (Z51)

2.5 dCi 4x4	2.488	140	4	01.2010-09.2014	YD25DDTi		EPBMPN3-A047Z	90252		
-------------	-------	-----	---	-----------------	----------	--	---------------	-------	--	--

NOTE (E11, NE11)

1.4	1.386	65	4	03.2006-06.2012	CR14DE		EPBMPT4-V016Z	92071	10	110
1.4	1.386	65	4	03.2006-06.2012	CR14DE		EPBMPN3-V001Z	90037	20	100
1.4 LPG	1.386	65	4	01.2006-08.2013	CR14DE		EPBMPT4-V016Z	92071	10	110
1.5 dCi	1.461	50	4	03.2006-06.2012	K9K700		EPBMPN3-V001Z	90037	20	100
1.5 dCi	1.461	50	4	03.2006-06.2012	K9K700		EPBBPN3-V007Z	97073	20	300
1.5 dCi	1.461	63	4	03.2006-06.2012	K9K276		EPBMPN3-V001Z	90037	20	100
1.5 dCi	1.461	63	4	03.2006-06.2012	K9K276		EPBBPN3-V007Z	97073	20	300
1.5 dCi	1.461	66	4	09.2010-06.2012	K9K276		EPBBPN3-V007Z	97073	20	300
1.5 dCi	1.461	76	4	07.2008-06.2012	K9K288, K9K292		EPBBPN3-V007Z	97073	20	300



MAP



l kW
C
Y
I



Type-N°

Stock-N°

kPa from
kPa to

NISSAN

NOTE (E11, NE11)

1.6	1.598	81	4	03.2006-06.2012	HR16DE		EPBMPN3-V001Z	90037	20	100
-----	-------	----	---	-----------------	--------	--	---------------	-------	----	-----

NOTE (E12)

1.2	1.198	59	3	06.2013-	HR12DE		EPBMPN3-A048Z	94778		
1.2	1.198	59	3	10.2015-	HR12DE		EPBMPN3-A050Z	96018		
1.2	1.198	59	3	12.2013-	HR12DE		EPBMPT4-A046Z	92256		
1.5 dCi	1.461	66	4	06.2013-	K9K608, K9K892		EPBMPN3-A048Z	94778		
1.5 dCi	1.461	66	4	06.2013-	K9K608, K9K892		EPBBPN3-V007Z	97073	20	300

NV200

1.5 dci	1.461	63	4	02.2010-	K9K400, K9K608, K9K628		EPBBPN3-V007Z	97073	20	300
1.5 dci	1.461	66	4	04.2011-	K9K892		EPBBPN3-V007Z	97073	20	300

NV400 (X62, X62B)

dCi 100	2.299	74	4	11.2011-05.2014	M9T670, M9T672, M9T676		EPBBPN3-V016Z	92713	50	350
dCi 110	2.299	81	4	06.2014-	M9T870		EPBBPN3-V016Z	92713	50	350
dCi 125	2.299	92	4	11.2011-09.2016	M9T670, M9T672, M9T676		EPBBPN3-V016Z	92713	50	350
dCi 125 RWD	2.299	92	4	11.2011-09.2016	M9T690, M9T686, M9T692, M9T696, M9T698		EPBBPN3-V016Z	92713	50	350
dCi 135	2.299	100	4	06.2014-09.2016	M9T696, M9T698, M9T702	; Position: Suction Pipe	EPBBPN3-V016Z	92713	50	350
dCi 135 RWD	2.299	100	4	06.2014-09.2016	M9T696, M9T698	; Position: Suction Pipe	EPBBPN3-V016Z	92713	50	350
dCi 145	2.299	107	4	11.2011-	M9T678, M9T680, M9T706		EPBBPN3-V016Z	92713	50	350
dCi 145 RWD	2.299	107	4	11.2011-	M9T694, M9T696, M9T698, M9T710		EPBBPN3-V016Z	92713	50	350
dCi 150	2.299	110	4	02.2014-	M9T880		EPBBPN3-V016Z	92713	50	350
dCi 150 RWD	2.299	110	4	02.2014-09.2016	M9T880		EPBBPN3-V016Z	92713	50	350
dCi 165	2.299	120	4	06.2014-09.2016	M9T	; Position: Suction Pipe	EPBBPN3-V016Z	92713	50	350
dCi 165 RWD	2.299	120	4	06.2014-	M9T	; Position: Suction Pipe	EPBBPN3-V016Z	92713	50	350
dCi 170	2.299	125	4	07.2015-	M9T	; Position: Suction Pipe	EPBBPN3-V016Z	92713	50	350

PATHFINDER III (R51)

3.0 dCi	2.993	170	6	08.2010-	V9X		EPBBPN3-V016Z	92713	50	350
---------	-------	-----	---	----------	-----	--	---------------	-------	----	-----

PATROL GR V WAGON (Y61) | SAFARI

3.0 DTi	2.953	116	4	06.2005-12.2006	ZD30DDTi		EPBMPN3-A052Z	93614		
3.0 DTi	2.953	118	4	06.2005-12.2006	ZD30DDTi		EPBMPN3-A052Z	93614		

PATROL VI (Y62)

5.6	5.552	298	8	04.2010-	VK56VD		EPBMPN3-A050Z	96018		
-----	-------	-----	---	----------	--------	--	---------------	-------	--	--

PRIMASTAR (X83)

dCi 80	1.870	60	4	01.2003-12.2007	F9Q762		EPBBPN3-V014Z	96895	20	250
dCi 80	1.870	60	4	03.2001-	F9Q762	; Position: Suction Pipe	EPBBPN3-V008Z	90842	20	250
1.9 dCi 100	1.870	74	4	-12.2002	F9Q760		EPBBPN3-V008Z	90842	20	250
dCi 100	1.870	74	4	03.2001-	F9Q760	; Position: Suction Pipe	EPBBPN3-V008Z	90842	20	250
dCi 90	1.995	66	4	09.2006-	M9R630, M9R692, M9R782, M9R786		EPBBPN3-V007Z	97073	20	300
dCi 90	1.995	66	4	09.2006-	M9R782, M9R786, M9R692		EPBBPN3-V016Z	92713	50	350



MAP



l kW
C
Y
I



Type-N°

Stock-N°

kPa from

kPa to

NISSAN

PRIMASTAR (X83)

dCi 120	1.995	84	4	09.2006-	M9R630, M9R692, M9R780, M9R786		EPBBPN3-V007Z	97073	20	300
dCi 120	1.995	84	4	09.2006-	M9R780, M9R786, M9R692		EPBBPN3-V016Z	92713	50	350
2.0	1.998	88	4	03.2001-	F4R720, F4R722		EPBMPN3-V001Z	90037	20	100
dCi 115	2.464	84	4	09.2008-	G9U630		EPBMBN3-V001Z	92099	20	256
dCi 115	2.464	84	4	09.2008-	G9U630		EPBBPN3-V007Z	97073	20	300
dCi 140	2.464	99	4	07.2003-	G9U730		EPBMBN3-V001Z	92099	20	256
dCi 140	2.464	99	4	07.2003-	G9U730		EPBBPN3-V007Z	97073	20	300
dCi 150	2.464	107	4	09.2006-	G9U632		EPBMBN3-V001Z	92099	20	256
dCi 150	2.464	107	4	10.2006-	G9U632		EPBBPN3-V007Z	97073	20	300

PRIMERA (P12, WP12)

1.9 dCi	1.870	85	4	08.2002-10.2007	F9Q		EPBBPN3-V007Z	97073	20	300
1.9 dCi	1.870	88	4	04.2003-10.2007	F9Q		EPBBPN3-V007Z	97073	20	300
2.2 Di	2.184	93	4	01.2003-	YD22DDT		EPBMPN3-A052Z	93614		
2.2 dCi	2.184	102	4	04.2003-	YD22DDT		EPBMPN3-A052Z	93614		

PULSAR (C13)

1.2 DIG-T	1.197	85	4	10.2014-	HRA2DDT		EPBBPN3-V007Z	97073	20	300
1.6 DIG-T	1.618	140	4	02.2015-	MR16DDT		EPBMPN3-A047Z	90252		

QASHQAI / QASHQAI +2 I (J10, NJ10, JJ10E)

1.5 dCi	1.461	76	4	07.2008-12.2013	K9K282, K9K292		EPBBPN3-V007Z	97073	20	300
1.5 dCi	1.461	78	4	02.2007-12.2013	K9K282, K9K292		EPBMPN3-V001Z	90037	20	100
1.5 dCi	1.461	78	4	02.2007-12.2013	K9K282, K9K292		EPBBPN3-V007Z	97073	20	300
1.5 dCi	1.461	81	4	01.2010-12.2013	K9K430		EPBBPN3-V007Z	97073	20	300
1.6	1.598	84	4	02.2007-12.2013	HR16DE	; Transmission Number: F5	EPBMPN3-A050Z	96018		
1.6	1.598	84	4	02.2007-12.2013	HR16DE		EPBMPN3-V001Z	90037	20	100
1.6	1.598	86	4	11.2010-12.2013	HR16DE	; Transmission Number: F5	EPBMPN3-A050Z	96018		
2.0 dCi	1.995	110	4	02.2007-12.2013	M1D	; Position: Suction Pipe	EPBBPN3-V016Z	92713	50	350
2.0 dCi All-wheel Drive	1.995	110	4	02.2007-12.2013	M1D	; Position: Suction Pipe	EPBBPN3-V016Z	92713	50	350
2.0 dCi	1.995	110	4	02.2007-12.2013	M9R		EPBBPN3-V016Z	92713	50	350
2.0 dCi All-wheel Drive	1.995	110	4	02.2007-12.2013	M9R		EPBBPN3-V016Z	92713	50	350

QASHQAI II SUV (J11, J11_)

1.2 DIG-T	1.197	85	4	11.2013-	HRA2DDT		EPBMPN3-A048Z	94778		
1.6 dCi ALL MODE 4x4-i	1.598	96	4	11.2013-	R9M	; Position: Suction Pipe	EPBBPN3-V016Z	92713	50	350
1.6 DIG-T	1.618	120	4	10.2014-	MR16DDT		EPBMPN3-A049Z	93927		
1.6 DIG-T	1.618	120	4	10.2014-	MR16DDT		EPBMPN3-A047Z	90252		

TIIDA (C11, SC11)

1.5 dCi	1.461	78	4	09.2007-12.2011	K9K728		EPBBPN3-V007Z	97073	20	300
1.6	1.598	81	4	09.2007-12.2011	HR16DE		EPBMPN3-V001Z	90037	20	100
1.8	1.798	93	4	09.2007-12.2011	MR18DE		EPBMPN3-V001Z	90037	20	100



MAP



l kW
C
Y
I



Type-N°

Stock-N°

kPa from

kPa to

NISSAN

X-TRAIL (T30)

2.2 Di 4x4	2.184	84	4	09.2003-	YD22DDTi, YD22ETi		EPBMPN3-A052Z	93614		
------------	-------	----	---	----------	-------------------	--	---------------	-------	--	--

X-TRAIL (T31)

2.0	1.997	104	4	06.2007-11.2013	MR20DE		EPBMPN3-V001Z	90037	20	100
2.0 dCi FWD	1.995	110	4	06.2007-11.2013	M9R		EPBBPN3-V016Z	92713	50	350
2.0 dCi 4x4	1.995	110	4	06.2007-11.2013	M9R		EPBBPN3-V016Z	92713	50	350
2.0 dCi 4x4	1.995	110	4	06.2007-11.2013	M9R		EPBMPN3-V001Z	90037	20	100
2.0 dCi	1.995	127	4	06.2007-11.2013	M9R760		EPBBPN3-V016Z	92713	50	350
2.0 dCi	1.995	127	4	06.2007-11.2013	M9R760		EPBMPN3-V001Z	90037	20	100
2.0 dCi 4x4	1.995	130	4	10.2009-11.2013	M9R760		EPBBPN3-V016Z	92713	50	350
2.5 4x4	2.488	124	4	06.2007-11.2013	QR25DE		EPBMPN3-V001Z	90037	20	100

X-TRAIL (T32_)

1.6 DIG-T	1.618	120	4	06.2015-	MR16DDT		EPBMPN3-A047Z	90252		
-----------	-------	-----	---	----------	---------	--	---------------	-------	--	--

OPEL

ADAM (M13)

1.2	1.229	51	4	10.2012-02.2019	A12XEL, B12XEL		EPBMPN3-V017Z	91253	10	120
1.4 LPG	1.398	64	4	07.2013-11.2018	A14XEL, B14XEL		EPBMPN3-V017Z	91253	10	120
1.4	1.398	64	4	10.2012-02.2019	A14XEL, B14XEL		EPBMPN3-V017Z	91253	10	120
1.4	1.398	74	4	10.2012-02.2019	A14XER, B14XER		EPBMPN3-V017Z	91253	10	120
1.4 S	1.364	110	4	11.2014-01.2019	B14NEH		EPBBPN3-V029Z	92983	20	270

AGILA A (H00)

1.3 CDTI	1.248	51	4	08.2003-12.2007	Z13DT		EPBMBN3-V001Z	92099	20	256
----------	-------	----	---	-----------------	-------	--	---------------	-------	----	-----

AGILA B (H08)

1.0	996	48	3	04.2008-06.2011	K10B	; Chass. <BM999999	EPBMPN3-V026Z	94423	10	117,9
1.0 LPG	996	48	3	01.2010-06.2011	K10B	; Chass. <BM999999	EPBMPN3-V026Z	94423	10	117,9
1.0	996	50	3	07.2011-07.2014	K10B	; Chass. <BM999999	EPBMPN3-V026Z	94423	10	117,9
1.2	1.242	63	4	04.2008-10.2012	K12B	; Chass. <AM999999	EPBMPN3-V026Z	94423	10	117,9
1.2 LPG	1.242	63	4	04.2008-10.2010	K12B	; Chass. <AM999999	EPBMPN3-V026Z	94423	10	117,9
1.2	1.242	69	4	04.2010-10.2014	K12B	; Chass. <AM999999	EPBMPN3-V026Z	94423	10	117,9
1.3 CDTI	1.248	55	4	04.2008-04.2010	Z13DTJ		EPBMBN3-V001Z	92099	20	256

AMPERA (R12)

EV 150	1.398	111	4	11.2011-03.2015	A14XFL		EPBMPN3-V017Z	91253	10	120
--------	-------	-----	---	-----------------	--------	--	---------------	-------	----	-----

ANTARA (L07)

2.4	2.405	103	4	09.2008-12.2011	Z24XE		EPBMPN3-V018Z	97066	20	950
2.4 LPG	2.405	103	4	10.2008-	Z24XE		EPBMPN3-V018Z	97066	20	950
2.4 4x4	2.405	103	4	08.2006-12.2011	Z24XE		EPBMPN3-V018Z	97066	20	950
2.4 LPG 4x4	2.405	103	4	08.2006-12.2010	Z24XE		EPBMPN3-V018Z	97066	20	950
2.4	2.384	123	4	12.2010-	A24XE		EPBMPN3-V017Z	91253	10	120
2.4 4x4	2.384	123	4	12.2010-	A24XE		EPBMPN3-V017Z	91253	10	120



MAP



l kW
C
Y
I



Type-Nº

Stock-Nº

kPa from

kPa to

OPEL

ANTARA (L07)

3.0	2.997	183	6	07.2013-	A30XH		EPBMPN3-V017Z	91253	10	120
3.0	2.997	190	6	11.2010-12.2015	A30XH		EPBMPN3-V017Z	91253	10	120

ASTRA F (T92)

1.4 i	1.389	44	4	09.1991-08.2002	C14NZ, X14NZ		EPBMPN3-A003Z	92477	15	102
1.4 Si	1.389	60	4	03.1992-03.2001	14SE, C14SE		EPBMPN3-A003Z	92477	15	102
1.4 i 16V	1.389	66	4	01.1996-03.2001	X14XE		EPBMPN3-A003Z	92477	15	102
1.6 i	1.598	52	4	02.1993-07.1996	X16SZ		EPBMPN3-A003Z	92477	15	102
1.6 i	1.598	55	4	09.1991-08.2002	16LZ2, 16NZR, C16NZ, X16SZR		EPBMPN3-A003Z	92477	15	102
1.6 Si	1.598	74	4	03.1992-12.1994	C16SE		EPBMPN3-A003Z	92477	15	102
1.6 i 16V	1.598	74	4	08.1994-01.2005	X16XEL		EPBMPN3-A003Z	92477	15	102
1.8 i	1.796	66	4	03.1991-09.1998	C18NZ		EPBMPN3-A003Z	92477	15	102
1.8 i 16V	1.799	92	4	06.1993-10.1994	C18XE		EPBMPN3-A003Z	92477	15	102

ASTRA G (F35, F70, T98)

1.4 16V Classic	1.389	66	4	05.2004-07.2009	Z14XE		EPBMPN3-V005Z	93871	20	100
1.4 16V	1.389	66	4	02.1998-07.2009	X14XE, Z14XE		EPBMPN3-A003Z	92477	15	102
1.6	1.598	55	4	02.1998-09.2000	X16SZR		EPBMPN3-A003Z	92477	15	102
1.6	1.598	62	4	09.2000-04.2005	Z16SE		EPBMPN3-V005Z	93871	20	100
1.6 CNG	1.598	71	4	03.2003-07.2004	Z16YNG		EPBMPN3-V005Z	93871	20	100
1.6 16V	1.598	74	4	02.1998-01.2005	C16SEL, X16XEL, Z16XE		EPBMPN3-A003Z	92477	15	102
1.6 LPG	1.598	74	4	03.1998-02.2006	X16XEL, Z16XE		EPBMPN3-V005Z	93871	20	100
1.6 16V	1.598	74	4	09.1998-01.2005	X16XEL, Z16XE		EPBMPN3-V005Z	93871	20	100
1.6	1.598	76	4	12.2002-12.2009	Z16XEP		EPBMPN3-V005Z	93871	20	100
1.6 16V	1.598	76	4	03.2000-05.2005	Z16XEP		EPBMPN3-V005Z	93871	20	100
1.6 LPG	1.598	76	4	06.2002-06.2007	Z16XEP		EPBMPN3-V005Z	93871	20	100
1.7 TD	1.700	50	4	02.1998-04.2005	X17DTL		EPBBPN3-A015Z	96911	20	250
1.7 DTI 16V	1.686	55	4	02.2000-01.2005	Y17DT		EPBMPN3-V006Z	97501	30	190
1.7 CDTI	1.686	59	4	04.2003-12.2009	Z17DTL	; Position: Intake Manifold	EPBBPN3-V010Z	95936	20	250
2.0 DI	1.995	60	4	02.1998-04.2005	X20DTL, Y20DTL		EPBBPN3-A015Z	96911	20	250
2.0 DTI 16V	1.995	74	4	08.1999-04.2005	Y20DTH	; Chass. <YH999999	EPBBPN3-A015Z	96911	20	250
2.0 DTI 16V	1.995	74	4	08.1999-04.2005	Y20DTH	; Chass. >12000001; Chass. <2H999999	EPBBPN3-A012Z	91308	25	290
2.0 DTI 16V	1.995	74	4	08.1999-01.2005	Y20DTH		EPBBPT4-V001Z	92565	11	307
2.0 16V Turbo	1.998	140	4	09.2000-08.2001	Z20LET		EPBBPT4-V010Z	91257	20	250
2.0 16V Turbo	1.998	141	4	08.2001-05.2005	Z20LET		EPBBPT4-V010Z	91257	20	250
2.0 OPC	1.998	141	4	03.2002-10.2005	Z20LET		EPBBPT4-V010Z	91257	20	250
2.0 16V Turbo	1.998	147	4	11.2002-10.2005	Z20LET		EPBBPT4-V010Z	91257	20	250
2.0 16V Turbo	1.998	147	4	11.2002-05.2005	Z20LET		EPBMPN3-V021Z	92226		



MAP



l kW
C
Y
I



Type-N°

Stock-N°

kPa from
kPa to

OPEL

ASTRA G (F35, F70, T98)

2.0 OPC	1.998	147	4	11.2002-01.2005	Z20LET		EPBBPT4-V010Z	91257	20	250
2.2 DTI	2.172	86	4	09.2002-01.2005	Y22DTR		EPBBPT4-V001Z	92565	11	307
2.2 DTI	2.172	92	4	09.2002-10.2005	Y22DTR		EPBBPT4-V001Z	92565	11	307
2.2 16V	2.198	108	4	03.2000-10.2005	Z22SE		EPBMPN3-V005Z	93871	20	100

ASTRA H (A04, L70)

1.3 CDTI	1.248	66	4	04.2005-10.2010	Z13DTH		EPBBPT4-V001Z	92565	11	307
1.6 EcoTec	1.598	76	4	02.2004-11.2004	Z16XEP		EPBMPN3-V005Z	93871	20	100
1.6	1.598	77	4	03.2004-10.2010	Z16XEP, Z16XE1		EPBMPN3-V005Z	93871	20	100
1.6 EcoTec	1.598	85	4	10.2006-12.2010	Z16XER		EPBMPN3-V041Z	92257	10	121,7
1.6 LPG	1.598	85	4	08.2009-10.2010	Z16XER		EPBMPN3-V041Z	92257	10	121,7
1.6	1.598	85	4	12.2006-05.2014	A16XER, Z16XER		EPBMPN3-V041Z	92257	10	121,7
1.6 Turbo	1.598	132	4	02.2007-10.2010	Z16LET		EPBMPN3-A028Z	93480	10	115
1.7 CDTI	1.686	59	4	03.2004-10.2010	Z17DTL		EPBBPN3-V010Z	95936	20	250
1.7 CDTI	1.686	74	4	03.2004-10.2010	Z17DTH		EPBBPN3-V010Z	95936	20	250
1.7 CDTI	1.686	81	4	02.2007-05.2014	A17DTJ, Z17DTJ		EPBMBT4-A002Z	92144	30,8	369,2
1.7 CDTI	1.686	92	4	02.2007-05.2014	A17DTR, Z17DTR		EPBMBT4-A002Z	92144	30,8	369,2
1.8	1.796	103	4	04.2006-09.2012	A18XER		EPBMPN3-V017Z	91253	10	120
1.8	1.796	103	4	08.2005-05.2014	Z18XER, A18XER		EPBMPN3-V041Z	92257	10	121,7
1.9 CDTI	1.910	74	4	09.2005-10.2010	Z19DTL		EPBBPT4-V001Z	92565	11	307
1.9 CDTI 16V	1.910	88	4	04.2004-10.2010	Z19DT, Z19DTJ		EPBBPT4-V001Z	92565	11	307
1.9 CDTI	1.910	110	4	09.2004-10.2010	Z19DTH		EPBBPT4-V001Z	92565	11	307
2.0 Turbo	1.998	125	4	03.2004-10.2010	Z20LEL		EPBMPN3-A028Z	93480	10	115
2.0 Turbo	1.998	147	4	09.2004-10.2010	Z20LER		EPBMPN3-A028Z	93480	10	115
2.0 Turbo	1.998	177	4	03.2005-10.2010	Z20LEH		EPBMPN3-A028Z	93480	10	115

ASTRA J (P10)

1.3 CDTI	1.248	70	4	12.2009-10.2015	A13DTE		EPBBPT4-V001Z	92565	11	307
1.4	1.398	64	4	12.2009-10.2015	A14XEL	; Position: Intake Manifold	EPBMPN3-V017Z	91253	10	120
1.4	1.398	74	4	12.2009-10.2015	A14XER, B14XER		EPBMPN3-V017Z	91253	10	120
1.4 Turbo	1.364	88	4	10.2010-10.2015	A14NEL, B14NEL	; Chass. >C8., C3., C1., CG.	EPBBPT4-V001Z	92565	11	307
1.4 Turbo	1.364	88	4	10.2010-10.2015	A14NEL, B14NEL	; Chass. >C1., CG., C8., C3.	EPBBPT4-V001Z	92565	11	307
1.4 Turbo	1.364	88	4	10.2011-	A14NEL, B14NEL	;	EPBMPN3-V017Z	91253	10	120
1.4 Turbo	1.364	88	4	10.2011-	A14NEL, B14NEL	;	EPBBPN3-V029Z	92983	20	270
1.4 Turbo	1.364	88	4	10.2010-10.2015	A14NEL, B14NEL	; ;	EPBMPN3-V017Z	91253	10	120
1.4 Turbo	1.364	88	4	10.2010-10.2015	A14NEL, B14NEL	; Position: Left	EPBBPN3-V029Z	92983	20	270
1.4	1.364	103	4	10.2011-	A14NET, B14NET	; Chass. >C8., C3., C1., CG.	EPBBPT4-V001Z	92565	11	307
1.4	1.364	103	4	10.2011-	A14NET, B14NET	;	EPBMPN3-V017Z	91253	10	120
1.4	1.364	103	4	10.2011-	A14NET, B14NET	;	EPBBPN3-V029Z	92983	20	270



MAP



l kW
C
Y
I



Type-N°

Stock-N°

kPa from

kPa to

OPEL

ASTRA J (P10)

1.4 Turbo	1.364	103	4	12.2009-10.2015	A14NET	;	EPBMPN3-V017Z	91253	10	120
1.4 Turbo	1.364	103	4	12.2009-10.2015	A14NET	; Position: Left	EPBBPN3-V029Z	92983	20	270
1.4 Turbo	1.364	103	4	10.2010-10.2015	A14NET, B14NET	; Chass. >C1., CG., C8., C3.	EPBBPT4-V001Z	92565	11	307
1.4 LPG	1.364	103	4	12.2011-10.2015	A14NET	; Chass. <BG999999; Chass. <B8999999; Chass. <B3999999	EPBBPT4-V010Z	91257	20	250
1.4 LPG	1.364	103	4	12.2011-10.2015	A14NET	; Position: Intake Manifold	EPBMPN3-V017Z	91253	10	120
1.4 LPG	1.364	103	4	12.2011-10.2015	A14NET	; Position: Intake Manifold	EPBBPN3-V029Z	92983	20	270
1.4 LPG	1.364	103	4	12.2011-10.2015	A14NET	; Chass. >C1., CG., C8., C3.	EPBBPT4-V001Z	92565	11	307
1.6	1.598	85	4	12.2009-10.2015	A16XER, B16XER		EPBMPN3-V017Z	91253	10	120
1.6 Turbo	1.598	132	4	12.2009-10.2015	A16LET		EPBBPT4-V010Z	91257	20	250
1.6 Turbo	1.598	132	4	12.2009-10.2015	A16LET	; Position: Intake Manifold	EPBMPN3-V017Z	91253	10	120
1.6 Turbo	1.598	132	4	12.2009-10.2015	A16LET	; Position: Intake Manifold	EPBBPN3-V029Z	92983	20	270
1.6 Turbo	1.598	132	4	10.2011-	A16LET	;	EPBMPN3-V017Z	91253	10	120
1.6 Turbo	1.598	132	4	10.2011-	A16LET	;	EPBBPN3-V029Z	92983	20	270
1.7 CDTI	1.686	81	4	09.2009-10.2015	A17DTC, A17DTE		EPBBPT4-V001Z	92565	11	307
1.7 CDTI	1.686	81	4	09.2009-10.2015	A17DTJ		EPBMBT4-A002Z	92144	30,8	369,2
1.7 CDTI	1.686	92	4	12.2009-10.2015	A17DTR		EPBMBT4-A002Z	92144	30,8	369,2
1.7 CDTI	1.686	96	4	07.2011-10.2015	A17DTF, A17DTS		EPBBPT4-V001Z	92565	11	307
1.8	1.796	103	4	10.2011-10.2015	A18XER		EPBMPN3-V017Z	91253	10	120
2.0 CDTI	1.956	118	4	09.2009-10.2015	A20DTH		EPBBPT4-V001Z	92565	11	307
2.0 CDTI	1.956	121	4	06.2011-10.2015	A20DTH		EPBBPT4-V001Z	92565	11	307

CASCADA (W13)

1.4	1.364	88	4	04.2013-04.2018	A14NEL, B14NEL		EPBBPN3-V029Z	92983	20	270
1.4 Turbo	1.364	103	4	03.2013-04.2018	A14NET, B14NET		EPBBPN3-V029Z	92983	20	270

COMBO (71_)

1.2	1.195	33	4	07.1994-10.2001	C12NZ, X12SZ		EPBMPN3-A003Z	92477	15	102
1.4	1.389	44	4	07.1994-10.2001	C14NZ, X14SZ		EPBMPN3-A003Z	92477	15	102
1.4	1.389	60	4	07.1994-10.2001	C14SE		EPBMPN3-A003Z	92477	15	102

COMBO (X12)

1.3 CDTI	1.248	66	4	02.2012-	A13FD		EPBBPT4-V001Z	92565	11	307
1.4	1.368	88	4	02.2012-	A14FC	; Euro 5	EPBBPT4-V010Z	91257	20	250
1.4	1.368	88	4	02.2012-	A14FC		EPBMBN3-V001Z	92099	20	256
1.4 CNG	1.368	88	4	02.2012-	A14FC	; Euro 5; Position: Intake Manifold	EPBBPT4-V010Z	91257	20	250
1.4 CNG	1.368	88	4	02.2012-	A14FC		EPBMBN3-V001Z	92099	20	256
1.6 CDTI	1.598	66	4	02.2012-	A16FDL		EPBBPT4-V001Z	92565	11	307
1.6 CDTI	1.598	74	4	02.2012-	A16FDL		EPBBPT4-V001Z	92565	11	307
1.6 CDTI	1.598	77	4	02.2012-	A16FDH		EPBBPT4-V001Z	92565	11	307
2.0 CDTI	1.956	99	4	02.2012-	A20FD		EPBBPT4-V001Z	92565	11	307



MAP



l kW
C
Y
I



Type-N°

Stock-N°

kPa from
kPa to

OPEL

COMBO BOX BODY/ESTATE

1.3 CDTI 16V	1.248	51	4	08.2005-	Z13DT		EPBMBN3-V001Z	92099	20	256
1.3 CDTI 16V	1.248	55	4	10.2005-12.2012	Z13DTJ		EPBMBN3-V001Z	92099	20	256
1.6	1.598	64	4	10.2001-	Z16SE		EPBMPN3-V005Z	93871	20	100
1.6 CNG 16V	1.598	69	4	06.2006-	Z16YNG		EPBMPN3-V005Z	93871	20	100
1.6 CNG 16V	1.598	71	4	04.2005-	Z16YNG		EPBMPN3-V005Z	93871	20	100
1.7 DI 16V	1.686	48	4	10.2001-	Y17DTL		EPBMPN3-V006Z	97501	30	190
1.7 DTI 16V	1.686	55	4	10.2001-	Y17DT		EPBMPN3-V006Z	97501	30	190
1.7 CDTI 16V	1.686	74	4	12.2004-	Z17DTH		EPBBPN3-V010Z	95936	20	250

COMBO TOUR

1.3 CDTI 16V	1.248	51	4	06.2004-01.2011	Z13DT		EPBMBN3-V001Z	92099	20	256
1.3 CDTI 16V	1.248	55	4	10.2005-12.2011	Z13DTJ		EPBMBN3-V001Z	92099	20	256
1.6	1.598	64	4	10.2001-09.2006	Z16SE		EPBMPN3-V005Z	93871	20	100
1.6 CNG	1.598	69	4	06.2006-12.2011	Z16YNG		EPBMPN3-V005Z	93871	20	100
1.6 CNG	1.598	71	4	04.2005-01.2011	Z16YNG		EPBMPN3-V005Z	93871	20	100
1.7 DI 16V	1.686	48	4	10.2001-06.2004	Y17DTL		EPBMPN3-V006Z	97501	30	190
1.7 DTI 16V	1.686	55	4	10.2001-06.2004	Y17DT		EPBMPN3-V006Z	97501	30	190
1.7 CDTI 16V	1.686	74	4	07.2004-12.2011	Z17DTH		EPBBPN3-V010Z	95936	20	250

CORSA A (S83)

1.2 i	1.195	33	4	09.1989-03.1993	C12NZ		EPBMPN3-A003Z	92477	15	102
1.2 N	1.196	38	4	01.1990-03.1993	12NV		EPBMPN3-A036Z	95612	20	105
1.2 S	1.196	40	4	09.1982-03.1993	12ST		EPBMPN3-A036Z	95612	20	105
1.2 S	1.196	43	4	09.1982-10.1987	12S		EPBMPN3-A036Z	95612	20	105
1.2	1.196	44	4	09.1982-08.1990	12S		EPBMPN3-A036Z	95612	20	105
1.3	1.297	44	4	09.1985-10.1989	13NB		EPBMPN3-A003Z	92477	15	102
1.3 i	1.297	44	4	09.1986-09.1990	C13N		EPBMPN3-A003Z	92477	15	102
1.3 S	1.297	51	4	09.1982-10.1989	13SB		EPBMPN3-A036Z	95612	20	105
1.4 i	1.389	44	4	10.1989-03.1993	C14NZ		EPBMPN3-A003Z	92477	15	102
1.4 Si	1.389	60	4	09.1991-03.1993	C14SE		EPBMPN3-A003Z	92477	15	102
1.6 GSI Cat	1.598	74	4	02.1992-03.1993	C16SE		EPBMPN3-A003Z	92477	15	102
1.6 GSI	1.598	74	4	05.1988-03.1992	E16SE		EPBMPN3-A036Z	95612	20	105

CORSA B (S93)

1.2 i	1.195	33	4	03.1993-09.2000	C12NZ, X12SZ		EPBMPN3-A003Z	92477	15	102
1.2 i	1.195	33	4	03.1993-09.2000	12NZ		EPBMPN3-A003Z	92477	15	102
1.4 i	1.389	44	4	03.1993-09.2000	C14NZ, X14SZ		EPBMPN3-A003Z	92477	15	102
1.4 Si	1.389	60	4	03.1993-09.2000	C14SE		EPBMPN3-A003Z	92477	15	102
1.4 i 16V	1.389	66	4	09.1994-09.2000	X14XE		EPBMPN3-A003Z	92477	15	102
1.6 i 16V	1.598	78	4	09.1994-09.2000	X16XE		EPBMPN3-A003Z	92477	15	102



MAP



l kW
C
Y
I



Type-N°

Stock-N°

kPa from

kPa to

OPEL

CORSA C (X01)

1.3 CDTI	1.248	51	4	06.2003-12.2009	Y13DT, Z13DT		EPBMBN3-V001Z	92099	20	256
1.4	1.389	66	4	09.2000-12.2009	Z14XE		EPBMPN3-V005Z	93871	20	100
1.7 DI	1.686	48	4	09.2000-12.2009	Y17DTL		EPBMPN3-V006Z	97501	30	190
1.7 DTI	1.686	55	4	09.2000-12.2009	Y17DT		EPBMPN3-V006Z	97501	30	190
1.7 CDTI	1.686	74	4	06.2003-12.2012	Z17DTH		EPBBPN3-V010Z	95936	20	250

CORSA D (S07)

1.0	998	44	3	07.2006-12.2010	Z10XEP		EPBMPN3-V010Z	93991	10	117,5
1.0	998	44	3	08.2006-08.2014	A10XEP	; Position: Intake Manifold	EPBMPN3-V017Z	91253	10	120
1.0	998	48	3	12.2009-08.2014	A10XEP	; Position: Intake Manifold	EPBMPN3-V017Z	91253	10	120
1.2	1.229	51	4	12.2009-08.2014	A12XEL	; Position: Intake Manifold	EPBMPN3-V017Z	91253	10	120
1.2 LPG	1.229	55	4	09.2009-12.2011	Z12XEP		EPBMPN3-V010Z	93991	10	117,5
1.2	1.229	59	4	07.2006-08.2014	Z12XEP		EPBMPN3-V010Z	93991	10	117,5
1.2 LPG	1.229	59	4	08.2006-08.2014	Z12XEP		EPBMPN3-V010Z	93991	10	117,5
1.2 LPG	1.229	61	4	06.2011-08.2014	A12XER		EPBMPN3-V017Z	91253	10	120
1.2 LPG	1.229	63	4	06.2011-08.2014	A12XER	; Position: Intake Manifold	EPBMPN3-V017Z	91253	10	120
1.2	1.229	63	4	12.2009-08.2014	A12XER	; Position: Intake Manifold	EPBMPN3-V017Z	91253	10	120
1.3 CDTI	1.248	55	4	07.2006-08.2014	Z13DTJ		EPBMBN3-V001Z	92099	20	256
1.3 CDTI	1.248	55	4	07.2006-08.2014	A13DTC		EPBBPT4-V001Z	92565	11	307
1.3 CDTI	1.248	66	4	07.2006-06.2011	Z13DTH		EPBBPT4-V001Z	92565	11	307
1.3 CDTI	1.248	70	4	11.2009-08.2014	A13DTE, A13DTR, Z13DTE		EPBBPT4-V001Z	92565	11	307
1.4 LPG	1.398	64	4	09.2009-08.2014	A14XEL	; Position: Intake Manifold	EPBMPN3-V017Z	91253	10	120
1.4	1.398	64	4	09.2009-08.2014	A14XEL	; Position: Intake Manifold	EPBMPN3-V017Z	91253	10	120
1.4	1.364	66	4	07.2006-08.2014	Z14XEP		EPBMPN3-V010Z	93991	10	117,5
1.4 LPG	1.364	66	4	08.2006-12.2011	Z14XEP		EPBMPN3-V010Z	93991	10	117,5
1.4	1.398	74	4	12.2009-08.2014	A14XER	; Position: Intake Manifold	EPBMPN3-V017Z	91253	10	120
1.4	1.364	88	4	07.2012-08.2014	A14NEL		EPBBPN3-V029Z	92983	20	270
1.6 Turbo	1.598	110	4	05.2007-08.2014	A16LEL, Z16LEL		EPBBPT4-V010Z	91257	20	250
1.6	1.598	141	4	07.2012-08.2014	Z16LER		EPBMPN3-V017Z	91253	10	120
1.6 Turbo	1.598	141	4	11.2006-08.2014	A16LER, B16LER, Z16LER		EPBMPN3-A028Z	93480	10	115
1.6 Turbo	1.598	155	4	06.2011-08.2014	A16LES		EPBMPN3-A028Z	93480	10	115
1.7 CDTI	1.686	92	4	08.2006-12.2011	Z17DTR		EPBMBT4-A002Z	92144	30,8	369,2
1.7 CDTI	1.686	96	4	12.2009-08.2014	A17DTS		EPBBPT4-V001Z	92565	11	307

CORSA E (X15)

1.2	1.229	51	4	09.2014-	B12XEL		EPBMPN3-V017Z	91253	10	120
1.4	1.398	55	4	09.2014-	B14XEJ		EPBMPN3-V017Z	91253	10	120
1.4 LPG	1.398	64	4	11.2015-	B14XEL		EPBMPN3-V017Z	91253	10	120
1.4 LPG	1.398	66	4	03.2015-	B14XEL		EPBMPN3-V017Z	91253	10	120



MAP

 l kW
C
Y
I

Type-N°

Stock-N°

 kPa from
kPa to

OPEL
CORSA E (X15)

1.4	1.398	66	4	09.2014-	B14XEL		EPBMPN3-V017Z	91253	10	120
1.4 Turbo	1.364	74	4	09.2014-06.2019	B14NEJ		EPBBPN3-V029Z	92983	20	270
1.4 Turbo	1.364	110	4	03.2015-	B14NEH, D14NEH		EPBBPN3-V029Z	92983	20	270
1.6 Turbo	1.598	152	4	03.2015-	B16LES	;	EPBMPN3-V017Z	91253	10	120
1.6 Turbo	1.598	152	4	03.2015-	B16LES	; Position: Left	EPBBPN3-V029Z	92983	20	270

FRONTERA B (U99)

2.2 DTI	2.171	85	4	09.1998-12.2003	X22DTH, Y22DTH		EPBBPT4-V001Z	92565	11	307
2.2 DTI	2.171	85	4	09.1998-12.2003	X22DTH, Y22DTH	; Chass. <2V599999	EPBMPN3-A028Z	93480	10	115
2.2 DTI	2.171	85	4	09.1998-12.2003	X22DTH, Y22DTH	; Chass. <2V599999	EPBBPN3-A015Z	96911	20	250
2.2 DTI	2.171	88	4	09.2002-07.2004	Y22DTH	; Chass. <2V599999	EPBBPN3-A015Z	96911	20	250
2.2 DTI	2.171	88	4	09.2002-07.2004	Y22DTH	; Chass. <2V599999	EPBMPN3-A028Z	93480	10	115
2.2 DTI	2.171	88	4	09.2002-07.2004	Y22DTH		EPBBPT4-V001Z	92565	11	307
2.2 i	2.198	100	4	10.1998-07.2004	X22SE, Y22SE		EPBMPN3-V005Z	93871	20	100
3.2 i	3.165	151	6	10.1998-07.2004	6VD1, Y32NE		EPBMPN3-V005Z	93871	20	100

GT (M07)

2.0	1.998	194	4	06.2007-12.2011	Z20NHH		EPBMPN3-A044Z	93056		
2.0	1.998	194	4	06.2007-12.2011	LNF, Z20NHH		EPBMBT4-V004Z	96629	11,9	261,9

INSIGNIA A (G09)

1.4	1.364	103	4	04.2011-03.2017	A14NET, B14NET		EPBBPT4-V001Z	92565	11	307
1.4 LPG	1.364	103	4	07.2012-06.2013	A14NET	; Position: Left	EPBBPN3-V029Z	92983	20	270
1.4	1.364	103	4	09.2011-06.2013	A14NET	;	EPBBPN3-V029Z	92983	20	270
1.4 LPG	1.364	103	4	07.2012-03.2017	A14NET, B14NET	; Position: Left	EPBBPN3-V029Z	92983	20	270
1.6	1.598	85	4	07.2008-03.2017	A16XER		EPBMPN3-V017Z	91253	10	120
1.6 Turbo	1.598	132	4	07.2008-03.2017	A16LET		EPBMPN3-V017Z	91253	10	120
1.8	1.796	103	4	07.2008-03.2017	A18XER, B18XER		EPBMPN3-V017Z	91253	10	120
2.0 CDTI	1.956	81	4	07.2008-03.2017	A20DTC, A20DTL		EPBBPT4-V001Z	92565	11	307
2.0 CDTI	1.956	96	4	07.2008-03.2017	A20DT, A20DTJ		EPBBPT4-V001Z	92565	11	307
2.0 CDTI 4x4	1.956	118	4	06.2010-03.2017	A20DTH		EPBBPT4-V001Z	92565	11	307
2.0 CDTI	1.956	118	4	07.2008-03.2017	A20DTH		EPBBPT4-V001Z	92565	11	307
2.0 CDTI	1.956	120	4	07.2013-03.2017	A20DTH		EPBBPT4-V001Z	92565	11	307
2.0 Turbo	1.998	162	4	07.2008-03.2017	A20NHT		EPBMPN3-A044Z	93056		
2.0 Turbo	1.998	162	4	07.2008-03.2017	A20NHT		EPBMBT4-V004Z	96629	11,9	261,9
2.0 Turbo 4x4	1.998	162	4	07.2008-03.2017	A20NHT		EPBMPN3-A044Z	93056		
2.0 Turbo 4x4	1.998	162	4	07.2008-03.2017	A20NHT		EPBMBT4-V004Z	96629	11,9	261,9
2.0 E85 Turbo	1.998	162	4	10.2010-03.2017	A20NFT		EPBMPN3-A044Z	93056		
2.0 E85 Turbo	1.998	162	4	10.2010-03.2017	A20NFT, A20NHT		EPBMBT4-V004Z	96629	11,9	261,9
2.0 Turbo	1.998	184	4	04.2014-03.2017	A20NHT, B20NHT		EPBMPN3-A044Z	93056		



MAP



l kW
C
Y
I



Type-N°

Stock-N°

kPa from

kPa to

OPEL

INSIGNIA A (G09)

2.0 Turbo 4x4	1.998	184	4	07.2011-03.2017	A20NFT, A20NHT, B20NHT		EPBMPN3-A044Z	93056		
2.0 Turbo 4x4	1.998	184	4	07.2011-03.2017	A20NFT, A20NHT, B20NHT		EPBMBT4-V004Z	96629	11,9	261,9
2.0 Turbo 4x4	1.998	184	4	07.2011-03.2017	A20NFT	; Position: Air Filter Housing	EPBMPN3-V017Z	91253	10	120

KADETT E (T85)

1.3 i Cat	1.297	44	4	09.1985-08.1991	C13N		EPBMPN3-A003Z	92477	15	102
1.3 N	1.297	44	4	09.1984-08.1991	13N, 13NB		EPBMPN3-A003Z	92477	15	102
1.3 N	1.297	44	4	09.1984-08.1991	13N, 13NB	; Sweden; Switzerland	EPBMPN3-A036Z	95612	20	105
1.3 S	1.297	55	4	09.1984-02.1993	13S	; Sweden; Switzerland	EPBMPN3-A036Z	95612	20	105
1.4 i	1.389	44	4	01.1990-07.1994	C14NZ		EPBMPN3-A003Z	92477	15	102
1.4 S	1.389	60	4	09.1989-08.1991	C14SE		EPBMPN3-A003Z	92477	15	102
1.6 i	1.598	55	4	09.1986-08.1991	E16NZ		EPBMPN3-A003Z	92477	15	102
1.6 i Cat	1.598	55	4	09.1986-02.1993	C16LZ, C16NZ		EPBMPN3-A003Z	92477	15	102
1.6 i	1.598	55	4	08.1989-07.1994	C16NZ		EPBMPN3-A003Z	92477	15	102
1.6 S	1.598	60	4	09.1986-08.1991	16SV	; Engine No. <0A027024	EPBMPN3-A036Z	95612	20	105
1.6 S	1.598	60	4	09.1986-08.1991	16SV		EPBMPN3-A003Z	92477	15	102
1.6	1.598	60	4	09.1986-12.1991	16SV	; Engine No. <0A027024	EPBMPN3-A036Z	95612	20	105
1.6	1.598	60	4	09.1986-12.1991	16SV		EPBMPN3-A003Z	92477	15	102
1.6 i	1.598	60	4	07.1989-02.1993	16SV	; Engine No. <0A027024	EPBMPN3-A036Z	95612	20	105
1.6 i	1.598	60	4	07.1989-02.1993	16SV		EPBMPN3-A003Z	92477	15	102

MERIVA A MPV (X03)

1.3 CDTI	1.248	51	4	04.2005-05.2010	Z13DT		EPBMBN3-V001Z	92099	20	256
1.3 CDTI	1.248	55	4	09.2003-05.2010	Z13DTJ		EPBMBN3-V001Z	92099	20	256
1.6	1.598	64	4	05.2003-05.2010	Z16SE		EPBMPN3-V005Z	93871	20	100
1.6 16V	1.598	74	4	05.2003-01.2006	Z16XE		EPBMPN3-V005Z	93871	20	100
1.6 Turbo	1.598	132	4	09.2005-05.2010	Z16LET		EPBMPN3-A028Z	93480	10	115
1.7 CDTI	1.686	74	4	09.2003-05.2010	Z17DT, Z17DTH		EPBMBT4-A002Z	92144	30,8	369,2
1.7 CDTI	1.686	74	4	09.2003-05.2010	Z17DT, Z17DTH		EPBBPN3-V010Z	95936	20	250
1.7 CDTI	1.686	92	4	09.2006-05.2010	A17DTR, Z17DTR		EPBMBT4-A002Z	92144	30,8	369,2

MERIVA B MPV (S10)

1.3 CDTI	1.248	70	4	06.2010-11.2014	A13DTE		EPBBPT4-V001Z	92565	11	307
1.4	1.398	74	4	06.2010-03.2017	A14XER, B14XER		EPBMPN3-V017Z	91253	10	120
1.4	1.364	88	4	06.2010-03.2017	A14NEL, B14NEL	; Chass. >C4000001	EPBBPT4-V001Z	92565	11	307
1.4	1.364	88	4	06.2010-03.2017	A14NEL, B14NEL	;	EPBMPN3-V017Z	91253	10	120
1.4	1.364	88	4	06.2010-03.2017	A14NEL, B14NEL	; Position: Left	EPBBPN3-V029Z	92983	20	270
1.4 LPG	1.364	88	4	06.2011-03.2017	B14NEL	; Chass. <B4999999	EPBBPT4-V010Z	91257	20	250
1.4 LPG	1.364	88	4	06.2011-03.2017	A14NEL, B14NEL	; Chass. >C4000001	EPBBPT4-V001Z	92565	11	307
1.4 LPG	1.364	88	4	06.2011-03.2017	A14NEL	;	EPBMPN3-V017Z	91253	10	120



MAP



l kW
C
Y
I



Type-N°

Stock-N°

kPa from
kPa to

OPEL

MERIVA B MPV (S10)

1.4 LPG	1.364	88	4	06.2011-03.2017	B14NEL	; Position: Intake Manifold	EPBMPN3-V017Z	91253	10	120
1.4 LPG	1.364	88	4	06.2011-03.2017	A14NEL	;	EPBBPN3-V029Z	92983	20	270
1.4	1.364	103	4	06.2010-03.2017	A14NET, B14NET	; Chass. >C4000001	EPBBPT4-V001Z	92565	11	307
1.4	1.364	103	4	06.2010-03.2017	A14NET, B14NET	;	EPBMPN3-V017Z	91253	10	120
1.4	1.364	103	4	06.2010-03.2017	A14NET, B14NET	; Position: Left	EPBBPN3-V029Z	92983	20	270
1.7 CDTI	1.686	74	4	06.2010-01.2017	A17DT		EPBMBT4-A002Z	92144	30,8	369,2
1.7 CDTI	1.686	81	4	06.2010-06.2015	A17DTC, A17DTI		EPBBPT4-V001Z	92565	11	307
1.7 CDTI	1.686	96	4	06.2010-10.2013	A17DTS		EPBBPT4-V001Z	92565	11	307

MOKKA / MOKKA X (J13)

1.4	1.364	103	4	04.2013-	A14NET, B14NET, D14NET		EPBBPN3-V029Z	92983	20	270
1.4 LPG	1.364	103	4	04.2013-	A14NET, B14NET, D14NET		EPBBPN3-V029Z	92983	20	270
1.4 4x4	1.364	103	4	06.2012-	A14NET, B14NET, D14NET		EPBBPN3-V029Z	92983	20	270
1.6	1.598	85	4	06.2012-	A16XER, B16XER		EPBMPN3-V017Z	91253	10	120
1.8	1.796	103	4	01.2013-	A18XER		EPBMPN3-V017Z	91253	10	120
1.8 4x4	1.796	103	4	01.2013-	A18XER		EPBMPN3-V017Z	91253	10	120

MONTEREY B (M98)

3.0 DTI	2.999	117	4	07.1998-08.1999	4JX1		EPBMPN3-A033Z	96422	20	200
3.5 V6 24V	3.494	158	6	07.1998-08.1999	6VE1		EPBMPN3-V005Z	93871	20	100

MOVANO (X62)

2.3 CDTI FWD	2.298	74	4	05.2010-	M9T670, M9T672, M9T676, M9T690, M9T692, M9T876		EPBBPN3-V016Z	92713	50	350
2.3 CDTI FWD	2.298	81	4	02.2012-	M9T870		EPBBPN3-V016Z	92713	50	350
2.3 CDTI FWD	2.298	92	4	05.2010-	M9T670, M9T676, M9T672, M9T870, M9T876		EPBBPN3-V016Z	92713	50	350
2.3 CDTI RWD	2.298	92	4	05.2010-	M9T690, M9T686, M9T690, M9T692, M9T696		EPBBPN3-V016Z	92713	50	350
2.3 CDTI FWD	2.298	107	4	05.2010-	M9T678, M9T680, M9T880		EPBBPN3-V016Z	92713	50	350
2.3 CDTI RWD	2.298	107	4	05.2010-	M9T694, M9T696, M9T698, M9T896, M9T898		EPBBPN3-V016Z	92713	50	350
2.3 CDTI FWD	2.298	110	4	01.2013-	M9T880		EPBBPN3-V016Z	92713	50	350
2.3 CDTI RWD	2.298	110	4	01.2013-	M9T694, M9T696, M9T698		EPBBPN3-V016Z	92713	50	350

MOVANO (X70)

1.9 DTI	1.870	60	4	10.2001-	F9Q772		EPBBPN3-V008Z	90842	20	250
2.5 CDTI	2.464	74	4	10.2003-	G9U650		EPBBPN3-V007Z	97073	20	300
2.5 CDTI	2.464	88	4	10.2003-	G9U632, G9U650		EPBBPN3-V007Z	97073	20	300
2.5 CDTI	2.464	107	4	10.2003-	G9U632, G9U650		EPBBPN3-V007Z	97073	20	300
2.8 DTI	2.799	84	4	07.1998-10.2001	S9W700, S9W702		EPBMPN3-A033Z	96422	20	200

OMEGA A (V87)

1.8 N	1.796	60	4	09.1986-08.1987	18NV		EPBMPN3-A003Z	92477	15	102
1.8 S	1.796	66	4	09.1986-03.1994	18NV, 18SV		EPBMPN3-A003Z	92477	15	102



MAP



l kW
C
Y
I



Type-Nº

Stock-Nº

kPa from

kPa to

OPEL

OMEGA A (V87)

3.6 24V Lotus	3.638	277	6	08.1990-09.1992	C36GET		EPBMPN3-A033Z	96422	20	200
---------------	-------	-----	---	-----------------	--------	--	---------------	-------	----	-----

OMEGA B (V94)

2.0 DTI 16V	1.995	74	4	09.1997-09.2000	X20DTH		EPBBPN3-A015Z	96911	20	250
2.2 DTI 16V	2.171	81	4	09.2000-07.2003	Y22DTH		EPBMP4-V026Z	91770	12	236
2.2 DTI 16V	2.171	88	4	09.2000-07.2003	Y22DTH		EPBMP4-V026Z	91770	12	236
2.5 TD	2.497	96	6	04.1994-07.2003	X25DT, X25TD		EPBBPN3-A013Z	95023	30	245
2.5 DTI	2.497	110	6	09.2001-07.2003	Y25DT	; Position: Fuel Line	EPBBPN3-A020Z	91829	40	415
2.5 DTI	2.497	110	6	09.2001-07.2003	Y25DT		EPBBPN3-A005Z	90934	30	240

SIGNUM (Z03)

1.9 CDTI	1.910	74	4	08.2005-02.2008	Z19DTL		EPBBPT4-V001Z	92565	11	307
1.9 CDTI	1.910	88	4	04.2004-02.2008	Z19DT		EPBBPT4-V001Z	92565	11	307
1.9 CDTI	1.910	110	4	04.2004-02.2008	Z19DTH		EPBBPT4-V001Z	92565	11	307
2.0 DTI	1.995	74	4	05.2003-04.2004	Y20DTH		EPBBPT4-V001Z	92565	11	307
2.0 Turbo	1.998	129	4	05.2003-12.2008	Z20NET		EPBMP4-V026Z	91770	12	236
2.2 DTI	2.172	92	4	05.2003-04.2004	Y22DTR		EPBBPT4-V001Z	92565	11	307
2.2 direct	2.198	114	4	05.2003-09.2008	Z22YH		EPBMPN3-V005Z	93871	20	100
2.8 V6 Turbo	2.792	169	6	09.2005-12.2008	Z28NEL		EPBBPT4-V010Z	91257	20	250
2.8 V6 Turbo	2.792	184	6	01.2006-12.2008	Z28NET		EPBBPT4-V010Z	91257	20	250

SINTRA (APV)

2.2 DTI	2.171	85	4	07.1997-04.1999	X22DTH		EPBBPN3-A015Z	96911	20	250
2.2 DTI	2.171	85	4	07.1997-04.1999	X22DTH		EPBMPN3-A028Z	93480	10	115
2.2 i 16V	2.198	104	4	11.1996-04.1999	X22XE		EPBMPN3-A028Z	93480	10	115

SPEEDSTER (E01)

2.2	2.198	108	4	06.2000-08.2005	Z22SE		EPBMPN3-V005Z	93871	20	100
2.0 Turbo	1.998	147	4	08.2002-08.2006	Z20LET		EPBMPN3-A028Z	93480	10	115

TIGRA (S93)

1.4 16V	1.389	66	4	07.1994-12.2000	X14XE		EPBMPN3-A003Z	92477	15	102
1.6 16V	1.598	78	4	07.1994-08.1998	X16XE		EPBMPN3-A003Z	92477	15	102

TIGRA TWINTOP (X04)

1.3 CDTI	1.248	51	4	06.2004-12.2010	Z13DT		EPBMBN3-V001Z	92099	20	256
----------	-------	----	---	-----------------	-------	--	---------------	-------	----	-----

VECTRA A (J89)

1.6	1.598	51	4	08.1992-07.1993	C16LZ2		EPBMPN3-A003Z	92477	15	102
1.6 i	1.598	52	4	09.1993-11.1995	X16SZ		EPBMPN3-A003Z	92477	15	102
1.6 i	1.598	55	4	09.1988-11.1995	C16NZ, C16NZ2, E16NZ		EPBMPN3-A003Z	92477	15	102
1.6 i, 1.6 i Cat	1.598	55	4	09.1993-11.1995	16LZ2, C16LZ2		EPBMPN3-A003Z	92477	15	102
1.6	1.598	60	4	09.1988-05.1993	16SV		EPBMPN3-A003Z	92477	15	102
1.8 S	1.796	65	4	09.1988-07.1989	E18NVR		EPBMPN3-A003Z	92477	15	102
1.8 S 4x4	1.796	65	4	01.1989-07.1989	E18NVR		EPBMPN3-A003Z	92477	15	102



MAP

 l kW
C
Y
I

Type-N°

Stock-N°

 kPa from
kPa to

OPEL
VECTRA A (J89)

1.8 S	1.796	66	4	09.1989-10.1990	18SV		EPBMPN3-A003Z	92477	15	102
1.8 i	1.796	66	4	09.1988-10.1990	18SV		EPBMPN3-A003Z	92477	15	102
1.8 i Cat	1.796	66	4	03.1990-11.1995	C18NZ		EPBMPN3-A003Z	92477	15	102

VECTRA B (J96)

1.6 i	1.598	55	4	10.1995-07.2003	X16SZR		EPBMPN3-A003Z	92477	15	102
1.6 i 16V	1.598	74	4	10.1995-07.2002	X16XEL, Y16XE, Z16XE		EPBMPN3-A003Z	92477	15	102
2.0 DI 16V	1.995	60	4	11.1996-06.2000	X20DTL		EPBBPN3-A015Z	96911	20	250
2.0 DTI 16V	1.995	74	4	06.1997-07.2003	X20DTH		EPBBPN3-A015Z	96911	20	250
2.0 DTI 16V	1.995	74	4	06.1997-07.2003	Y20DTH		EPBBPN3-A012Z	91308	25	290
2.2 DTI 16V	2.172	88	4	09.2000-04.2002	Y22DTR		EPBBPN3-A012Z	91308	25	290
2.2 DTI 16V	2.172	92	4	09.2000-07.2003	Y22DTR		EPBBPN3-A012Z	91308	25	290
2.2 i 16V	2.198	108	4	09.2000-07.2003	Z22SE		EPBMPN3-V005Z	93871	20	100

VECTRA C (Z02)

1.6 16V	1.598	74	4	06.2004-09.2008	Z16XE		EPBMPN3-V005Z	93871	20	100
1.6 16V	1.598	74	4	06.2004-09.2008	Z16XE		EPBMPN3-A003Z	92477	15	102
1.6	1.598	77	4	08.2005-08.2008	Z16XEP		EPBMPN3-V005Z	93871	20	100
1.9 CDTI	1.910	74	4	10.2005-08.2008	Z19DTL		EPBBPT4-V001Z	92565	11	307
1.9 CDTI	1.910	88	4	04.2004-01.2009	Z19DT		EPBBPT4-V001Z	92565	11	307
1.9 CDTI	1.910	110	4	04.2004-08.2008	Z19DTH		EPBBPT4-V001Z	92565	11	307
2.0 DTI 16V	1.995	74	4	04.2002-08.2006	Y20DTH		EPBBPT4-V001Z	92565	11	307
2.0 16V Turbo	1.998	129	4	03.2003-08.2008	Z20NET		EPBMPT4-V026Z	91770	12	236
2.2 DTI 16V	2.172	92	4	04.2002-07.2006	Y22DTR		EPBBPT4-V001Z	92565	11	307
2.2 16V	2.198	108	4	04.2002-12.2008	Z22SE		EPBMPN3-V005Z	93871	20	100
2.2 direct	2.198	114	4	10.2003-08.2008	Z22YH		EPBMPN3-V005Z	93871	20	100
2.8 V6 Turbo	2.792	169	6	08.2005-10.2008	Z28NEL	; With Charger Intercooler	EPBBPT4-V010Z	91257	20	250
2.8 V6 Turbo	2.792	169	6	08.2005-10.2008	Z28NEL	; Position: Intake Manifold	EPBMPN3-V010Z	93991	10	117,5
2.8 V6 Turbo	2.792	184	6	08.2005-08.2008	Z28NET	; With Charger Intercooler	EPBBPT4-V010Z	91257	20	250
2.8 V6 Turbo	2.792	184	6	08.2005-08.2008	Z28NET	; Position: Intake Manifold	EPBMPN3-V010Z	93991	10	117,5
2.8 V6 Turbo	2.792	188	6	08.2005-09.2008	Z28NET	; With Charger Intercooler	EPBBPT4-V010Z	91257	20	250
2.8 V6 Turbo	2.792	188	6	08.2005-09.2008	Z28NET	; Position: Intake Manifold	EPBMPN3-V010Z	93991	10	117,5
2.8 V6 Turbo OPC	2.792	206	6	07.2006-08.2008	Z28NET	; With Charger Intercooler	EPBBPT4-V010Z	91257	20	250
2.8 V6 Turbo OPC	2.792	206	6	07.2006-08.2008	Z28NET	; Position: Intake Manifold	EPBMPN3-V010Z	93991	10	117,5

VIVARO A (X83)

1.9 DI	1.870	60	4	08.2001-	F9Q762		EPBBPN3-V008Z	90842	20	250
1.9 DTI	1.870	74	4	08.2001-	F9Q760		EPBBPN3-V008Z	90842	20	250
1.9 DTI	1.870	74	4	08.2001-	F9Q760		EPBBPN3-V007Z	97073	20	300
2.0 CDTI	1.995	66	4	08.2006-	M9R630	; Position: Suction Pipe	EPBBPN3-V016Z	92713	50	350



MAP



l kW
C
Y
I



Type-N°

Stock-N°

kPa from

kPa to

OPEL

VIVARO A (X83)

2.0 CDTI	1.995	66	4	08.2006-	M9R630, M9R780, M9R782, M9R786		EPBBPN3-V007Z	97073	20	300
2.0 CDTI	1.995	84	4	08.2006-	M9R692	; Position: Suction Pipe	EPBBPN3-V016Z	92713	50	350
2.0 CDTI	1.995	84	4	08.2006-	M9R630, M9R692, M9R780, M9R784, M9R786, M9R788		EPBBPN3-V007Z	97073	20	300
2.0 ECOTEC	1.998	86	4	08.2006-	F4R820		EPBMPN3-V001Z	90037	20	100
2.0 16V	1.998	88	4	08.2001-	F4R720		EPBMPN3-V001Z	90037	20	100
2.5 DTI	2.463	99	4	05.2003-	G9U730		EPBMBN3-V001Z	92099	20	256
2.5 DTI	2.463	99	4	05.2003-	G9U630		EPBBPN3-V007Z	97073	20	300
2.5 CDTI	2.463	107	4	08.2006-	G9MB6, G9U630		EPBMBN3-V001Z	92099	20	256
2.5 CDTI	2.463	107	4	08.2006-	G9MB6, G9U630		EPBBPN3-V007Z	97073	20	300
2.5 CDTI	2.464	84	4	08.2006-	G9U630		EPBMBN3-V001Z	92099	20	256
2.5 CDTI	2.464	84	4	08.2006-	G9U630		EPBBPN3-V007Z	97073	20	300

ZAFIRA A (T98)

1.6 CNG	1.598	71	4	09.2001-06.2005	Z16YNG		EPBMPN3-V005Z	93871	20	100
1.6 16V	1.598	74	4	04.1999-06.2005	Z16XE		EPBMPN3-V005Z	93871	20	100
1.6 16V	1.598	74	4	04.1999-06.2005	X16XEL, Z16XE		EPBMPN3-A003Z	92477	15	102
2.0 DI 16V	1.995	60	4	07.1999-06.2005	X20DTL		EPBBPN3-A015Z	96911	20	250
2.0 DI	1.995	63	4	07.1999-06.2000	X20DTL		EPBBPN3-A015Z	96911	20	250
2.0 DTI 16V	1.995	74	4	09.2000-06.2005	Y20DTH	; Chass. <Y2999999	EPBBPN3-A015Z	96911	20	250
2.0 DTI 16V	1.995	74	4	09.2000-06.2005	Y20DTH	; Chass. >12000001; Chass. <22999999	EPBBPN3-A012Z	91308	25	290
2.0 DTI 16V	1.995	74	4	09.2000-06.2005	Y20DTH		EPBBPT4-V001Z	92565	11	307
2.0 OPC	1.998	141	4	09.2001-06.2005	Z20LET		EPBBPT4-V010Z	91257	20	250
2.0 OPC	1.998	147	4	11.2002-06.2005	Z20LET		EPBBPT4-V010Z	91257	20	250
2.2 DTI 16V	2.172	92	4	01.2002-06.2005	Y22DTR		EPBBPT4-V001Z	92565	11	307
2.2 16V	2.198	108	4	09.2000-06.2005	Z22SE		EPBMPN3-V005Z	93871	20	100

ZAFIRA B (A05)

1.6 FlexFuel	1.598	85	4	08.2008-12.2012	Z16XER		EPBMPN3-V041Z	92257	10	121,7
1.6 CNG Turbo	1.598	110	4	02.2009-04.2015	Z16XNT		EPBBPT4-V010Z	91257	20	250
1.6 CNG Turbo	1.598	110	4	02.2009-04.2015	A16XNT		EPBBPT4-V010Z	91257	20	250
1.7 CDTI	1.686	81	4	01.2008-04.2015	A17DTJ, Z17DTJ		EPBMBT4-A002Z	92144	30,8	369,2
1.7 CDTI	1.686	92	4	01.2008-04.2015	A17DTR		EPBMBT4-A002Z	92144	30,8	369,2
1.8	1.796	88	4	06.2013-04.2015	A18XEL		EPBMPN3-V017Z	91253	10	120
1.8	1.796	103	4	07.2005-04.2015	A18XER, Z18XER		EPBMPN3-V041Z	92257	10	121,7
1.9 CDTI	1.910	74	4	07.2005-12.2010	Z19DTL		EPBBPT4-V001Z	92565	11	307
1.9 CDTI	1.910	88	4	07.2005-04.2015	Z19DT		EPBBPT4-V001Z	92565	11	307
1.9 CDTI	1.910	110	4	07.2005-04.2015	Z19DTH		EPBBPT4-V001Z	92565	11	307



MAP



l kW
C
Y
I



Type-N°

Stock-N°

kPa from
kPa to

OPEL

ZAFIRA TOURER C (P12)

1.4	1.364	88	4	10.2011-	A14NEL, B14NEL		EPBBPT4-V001Z	92565	11	307
1.4	1.364	88	4	10.2011-	A14NEL, B14NEL	;	EPBMPN3-V017Z	91253	10	120
1.4	1.364	88	4	10.2011-	A14NEL, B14NEL	;	EPBBPN3-V029Z	92983	20	270
1.4	1.364	103	4	10.2011-	A14NET, B14NET		EPBBPT4-V001Z	92565	11	307
1.4	1.364	103	4	10.2011-	A14NET, B14NET	;	EPBMPN3-V017Z	91253	10	120
1.4	1.364	103	4	10.2011-	A14NET, B14NET	;	EPBBPN3-V029Z	92983	20	270
1.4 LPG	1.364	103	4	10.2011-	A14NET, B14NET	;	EPBMPN3-V017Z	91253	10	120
1.4 LPG	1.364	103	4	10.2011-	A14NET, B14NET	; Position: Left	EPBBPN3-V029Z	92983	20	270
1.8	1.796	85	4	10.2011-	A18XEL		EPBMPN3-V017Z	91253	10	120
1.8	1.796	103	4	10.2011-	A18XER		EPBMPN3-V017Z	91253	10	120
2.0 CDTi	1.956	81	4	10.2011-	A20DTL		EPBBPT4-V001Z	92565	11	307
2.0 CDTi	1.956	96	4	10.2011-	A20DT, B20DTJ, D20DTJ, Y20DTJ, Z20DTJ		EPBBPT4-V001Z	92565	11	307
2.0 CDTi	1.956	121	4	10.2011-	A20DTH		EPBBPT4-V001Z	92565	11	307

PEUGEOT

108

1.0 VTi	998	51	3	05.2014-	CFB(1KR)		EPBMPT4-A030Z	96501	10	130
1.0 VTi 72	998	53	3	05.2018-	CFB(1KR)		EPBMPT4-A030Z	96501	10	130

301

1.6 HDi 90	1.560	68	4	11.2012-	9HF(DV6DTED), 9HJ(DV6DTEDM)	; Position: Intake Manifold	EPBMBT4-A003Z	93024	12,9	316,5
1.6 VTi 115	1.587	85	4	11.2012- 10.2017	NFP(EC5)	; Position: Intake Manifold	EPBMPT4-A001Z	93136	10	117

4008

1.6 HDi AWC	1.560	84	4	05.2012-	9HD(DV6C)	; Position: Suction Pipe	EPBMBT4-A003Z	93024	12,9	316,5
-------------	-------	----	---	----------	-----------	--------------------------	---------------	-------	------	-------

1007 (KM_)

1.4 HDi	1.398	50	4	04.2005-	8HX(DV4TD), 8HZ(DV4TD)		EPBBPN3-A006Z	91736	10	240
1.4	1.360	54	4	04.2005-	KFV(TU3A), KFV(TU3JP)		EPBMPT4-A001Z	93136	10	117
1.4 16V	1.360	65	4	10.2005-	KFU(ET3J4)		EPBMPT4-A001Z	93136	10	117
1.6 HDi	1.560	80	4	06.2007-	9HZ(DV6TED4)		EPBBPN3-A001Z	94263	10	240
1.6 16V	1.587	80	4	04.2005-	NFU(TU5JP4)		EPBMPT4-A001Z	93136	10	117

106 I (1A, 1C)

1.1	1.124	44	4	09.1991- 04.1996	HDZ(TU1M)		EPBMPN3-A035Z	92810	20	100
1.1	1.124	44	4	09.1991- 04.1996	HDZ(TU1M)		EPBMPN3-A002Z	96249	15	100
1.3	1.294	72	4	10.1993- 04.1996	TU2J2		EPBMPN3-A035Z	92810	20	100
1.6	1.587	65	4	06.1993- 04.1996	NFZ(TU5JP)		EPBMPN3-A027Z	90915	20	105
1.6	1.587	76	4	01.1994- 04.1996	NFY(TU5J2)		EPBMPN3-A035Z	92810	20	100

106 II (1A_, 1C_)

1.1 i	1.124	44	4	05.1996- 07.2004	HDZ(TU1M+), HFX(TU1JP)		EPBMPT4-A001Z	93136	10	117
1.4 i	1.360	55	4	05.1996- 07.2004	KFW(TU3JP), KFX(TU3JP)		EPBMPT4-A001Z	93136	10	117
1.4 i	1.360	55	4	-11.1998	KFW(TU3JP), KFX(TU3JP)	; Euro1, Euro2	EPBMPN3-A009Z	92952	20	100



MAP



l kW
C
Y
I



Type-N°

Stock-N°

kPa from

kPa to

PEUGEOT

106 II (1A_, 1C_)

1.6 i	1.587	65	4	05.1996-10.1999	NFZ(TU5JP)		EPBMPN3-A027Z	90915	20	105
1.6 i	1.587	74	4	05.1996-01.2001	NFW(TU5J2), NFY(TU5J2)		EPBMPN3-A035Z	92810	20	100
1.6 S16	1.587	87	4	-11.1998	NFX(TU5J4)	; Euro 2	EPBMPN3-A009Z	92952	20	100
1.6 S16	1.587	87	4	05.1996-07.2004	NFX(TU5J4)		EPBMPN3-A020Z	96725	20	117

107 (PM_, PN_)

1.0	998	50	3	06.2005-05.2014	CFA(384F), CFB(1KR)		EPBMPT4-A030Z	96501	10	130
1.4 HDi	1.398	40	4	06.2005-05.2014	8HT(DV4TD)		EPBBPN3-A006Z	91736	10	240

2008 I (CU_)

1.4 HDi	1.398	50	4	06.2013-	8HR(DV4C)		EPBBPN3-A017Z	95311	35	320
1.6 HDi	1.560	68	4	03.2013-	9HP(DV6DTEd)	; Position: Suction Pipe	EPBMBT4-A003Z	93024	12,9	316,5

206 / 206 SW (2A/C, 2E/K)

1.1	1.124	40	4	-11.1998	HFY(TU1JP)		EPBMPN3-A009Z	92952	20	100
1.1 i	1.124	44	4	-11.1998	HFX(TU1JP), HFZ(TU1JP)		EPBMPN3-A009Z	92952	20	100
1.1 i	1.124	44	4	09.1998-02.2007	HFX(TU1JP), HFZ(TU1JP)		EPBMPT4-A001Z	93136	10	117
1.4 HDi eco 70	1.398	50	4	09.2001-04.2009	8HX(DV4TD), 8HZ(DV4TD)		EPBBPN3-A006Z	91736	10	240
1.4 HDi	1.398	51	4	09.2002-02.2007	8HX(DV4TD)		EPBBPN3-A006Z	91736	10	240
1.4 i	1.360	55	4	09.1998-12.2012	KFV(TU3A), KFW(TU3A), KFX(TU3JP), KFX(TU3JP)		EPBMPT4-A001Z	93136	10	117
1.4 i	1.360	55	4	-10.1998	KFX(TU3JP), KFW(TU3JP), KFW(TU3A)	; Euro 2	EPBMPN3-A009Z	92952	20	100
1.4 16V	1.360	65	4	10.2003-	KFU(ET3J4)		EPBMPT4-A001Z	93136	10	117
1.6 i	1.587	65	4	-11.1998	NFZ(TU5JP)		EPBMPN3-A009Z	92952	20	100
1.6 HDi 110	1.560	80	4	05.2004-02.2007	9HY(DV6TED4), 9HZ(DV6TED4)		EPBBPN3-A001Z	94263	10	240
1.6 16V	1.587	80	4	07.2000-04.2009	NFU(TU5JP4)		EPBMPT4-A001Z	93136	10	117
2.0 S16	1.997	100	4	06.1999-12.2007	RFN(EW10J4)		EPBMPN3-A020Z	96725	20	117
2.0 RC	1.997	130	4	07.2003-12.2007	RFK(EW10J4S)		EPBMPT4-A001Z	93136	10	117

206 CC (2D)

1.6 16V	1.587	80	4	09.2000-12.2007	NFU(TU5JP4)		EPBMPT4-A001Z	93136	10	117
1.6 HDi 110	1.560	80	4	04.2005-02.2007	9HZ(DV6TED4)		EPBBPN3-A001Z	94263	10	240
2.0 S16	1.997	100	4	09.2000-12.2007	RFN(EW10J4)		EPBMPN3-A020Z	96725	20	117

206+ (2L_, 2M_)

1.1	1.124	44	4	01.2009-06.2013	HFX(TU1A)	; Position: Intake Manifold	EPBMPT4-A001Z	93136	10	117
1.4 HDi eco 70	1.398	50	4	01.2009-06.2013	8HZ(DV4TD)	; Position: Intake Manifold	EPBBPN3-A006Z	91736	10	240
1.4 i	1.360	54	4	09.2010-06.2013	KFT(TU3AE5)	; Position: Intake Manifold	EPBMPT4-A001Z	93136	10	117
1.4 i	1.360	55	4	01.2009-08.2013	KFW(TU3A)	; Position: Intake Manifold	EPBMPT4-A001Z	93136	10	117

207 / 207 SW (WK_, WA_, WC_)

1.4 HDi	1.398	50	4	02.2006-12.2015	8HZ(DV4TD), 8HR(DV4C)		EPBBPN3-A006Z	91736	10	240
1.4	1.360	53	4	02.2006-10.2013	KFV(TU3A)		EPBMPT4-A001Z	93136	10	117
1.4	1.360	54	4	06.2007-12.2012	KFT(TU3A), KFW(TU3A)		EPBMPT4-A001Z	93136	10	117



MAP



l kW
C
Y
I



Type-N°

Stock-N°

kPa from
kPa to

PEUGEOT

207 / 207 SW (WK_, WA_, WC_)

1.4 16V	1.360	65	4	02.2006-10.2013	KFU(ET3J4)		EPBMPT4-A001Z	93136	10	117
1.4 16V	1.397	70	4	06.2007-10.2013	8FS(EP3), EP3, EP3C		EPBMPT4-A006Z	96115		
1.6 HDi	1.560	66	4	02.2006-10.2013	9HV(DV6TED4B), 9HV(DV6TED4BU), 9HX(DV6ATED4)		EPBBPN3-A001Z	94263	10	240
1.6 HDi	1.560	68	4	11.2009-12.2012	9HP(DV6DTED)	; Position: Intake Manifold	EPBMBT4-A003Z	93024	12,9	316,5
1.6 HDi	1.560	68	4	11.2009-	9HP(DV6DTED)	; Position: Suction Pipe	EPBMBT4-A003Z	93024	12,9	316,5
1.6 16V	1.587	80	4	02.2006-10.2013	NFU(TU5JP4)		EPBMPT4-A001Z	93136	10	117
1.6 HDi	1.560	80	4	02.2006-10.2013	9HY(DV6TED4), 9HZ(DV6TED4)		EPBBPN3-A001Z	94263	10	240
1.6 HDi	1.560	82	4	08.2009-10.2013	9HR(DV6C)	; Position: Intake Manifold	EPBMBT4-A003Z	93024	12,9	316,5
1.6 16V	1.598	88	4	06.2007-10.2013	5FS(EP6C), 5FW(EP6), EP6		EPBMPT4-A006Z	96115		
1.6 16V Turbo	1.598	110	4	02.2006-10.2013	5FX(EP6DT)		EPBBPN3-A024Z	91449	50	350
1.6 16V Turbo	1.598	115	4	10.2009-12.2012	5FR(EP6DT)		EPBBPN3-A024Z	91449	50	350
1.6 16V RC	1.598	128	4	02.2007-12.2012	5FY(EP6DTS)		EPBBPN3-A024Z	91449	50	350

207 CC (WD_)

1.4	1.360	54	4	04.2006-10.2013	KFT(TU3A), KFT(TU-3AE5), KFV(TU3A)	; Position: Intake Manifold	EPBMPT4-A001Z	93136	10	117
1.6 HDi	1.560	80	4	02.2007-01.2015	9HZ(DV6TED4)		EPBBPN3-A001Z	94263	10	240
1.6 HDi	1.560	82	4	08.2009-10.2013	9HR(DV6C)	; Position: Intake Manifold	EPBMBT4-A003Z	93024	12,9	316,5
1.6 16V	1.598	88	4	02.2007-10.2013	5FS(EP6C), 5FW(EP6), EP6		EPBMPT4-A006Z	96115		
1.6 16V Turbo	1.598	110	4	02.2007-12.2012	5FX(EP6DT)		EPBBPN3-A024Z	91449	50	350
1.6 16V Turbo	1.598	115	4	10.2009-12.2013	5FR(EP6DT), 5FV(EP6CDT)		EPBBPN3-A024Z	91449	50	350

208 I (CA_, CC_)

1.4 HDi	1.398	50	4	03.2012-	8HR(DV4C), 8HP(DV4C)		EPBBPN3-A017Z	95311	35	320
1.6 HDi, BlueHDi 75	1.560	55	4	01.2013-	9HK(DV6ETEDM)	; Position: Intake Manifold	EPBMBT4-A003Z	93024	12,9	316,5
1.6 HDi	1.560	68	4	03.2012-	9HJ(DV6DTEDM), 9HP(DV6DTED)	; Position: Intake Manifold	EPBMBT4-A003Z	93024	12,9	316,5
1.6	1.598	115	4	03.2012-	5FV(EP6CDT)		EPBBPN3-V030Z	94092	50	465
1.6 THP 165	1.598	121	4	03.2015-	5GZ(EP6FDT)		EPBBPN3-V030Z	94092	50	465
1.6 GTi	1.598	147	4	08.2012-	5FU(EP6CDTX)		EPBBPN3-V030Z	94092	50	465
1.6 GTi	1.598	153	4	10.2014-	5GR(EP6FDTX)		EPBBPN3-V030Z	94092	50	465

3008 (OU_)

1.6 HDi	1.560	80	4	06.2009-08.2016	9HZ(DV6TED4)	; Position: Intake Manifold	EPBBPN3-A001Z	94263	10	240
1.6 HDi	1.560	82	4	12.2009-08.2016	9HR(DV6C)		EPBMBT4-A003Z	93024	12,9	316,5
1.6 VTi	1.598	88	4	06.2009-08.2016	5FS(EP6C), 5FW(EP6), EP6		EPBMPT4-A006Z	96115		
1.6 THP	1.598	110	4	06.2009-08.2016	5FX(EP6DT), 5FE(EP6CDTMD), 5FE(EP6CDTM)		EPBBPN3-A024Z	91449	50	350
1.6 THP	1.598	115	4	06.2009-08.2016	5FV(EP6CDT)	;	EPBBPN3-A024Z	91449	50	350
1.6 THP	1.598	115	4	06.2009-08.2016	5FV(EP6CDT)		EPBBPN3-V030Z	94092	50	465
1.6 Turbo	1.598	121	4	05.2014-08.2016	5GZ(EP6FDT)		EPBBPN3-V030Z	94092	50	465
2.0 HDi 150, BlueHDi 150	1.997	110	4	06.2009-08.2016	RHE(DW10CTED4)	; Position: Intake Manifold	EPBMBT4-A003Z	93024	12,9	316,5



MAP



l kW
C
Y
I



Type-N°

Stock-N°

kPa from

kPa to

PEUGEOT

3008 (0U_)

2.0 HDi Hybrid4	1.997	120	4	02.2011-08.2016	RHC(DW10CTED4)	; Position: Intake Manifold	EPBMBT4-A003Z	93024	12,9	316,5
2.0 HDi	1.997	120	4	06.2009-08.2016	RHH(DW10CTED4)	; Position: Intake Manifold	EPBMBT4-A003Z	93024	12,9	316,5

3008 SUV (M_)

1.6 THP 165	1.598	121	4	07.2016-	5GW(EP6FDT), 5GZ(EP6FDT)		EPBBPN3-V030Z	94092	50	465
-------------	-------	-----	---	----------	--------------------------	--	---------------	-------	----	-----

306 (N_, 7_)

1.4	1.360	55	4	04.1993-07.2001	KDX(TU3MC), KFW(TU3JP), KFX(TU3JP)		EPBMPT4-A001Z	93136	10	117
1.4	1.360	55	4	-11.1998	KFW(TU3JP), KFX(TU3JP)		EPBMPN3-A009Z	92952	20	100
1.4	1.360	55	4	11.1998-	KFW(TU3JP), KFX(TU3JP)		EPBMPN3-A007Z	96754	20	105
1.6	1.587	65	4	02.1999-	NFZ(TU5JP)		EPBMPN3-A007Z	96754	20	105
1.6	1.587	65	4	05.1997-05.1998	NFZ(TU5JP)		EPBMPN3-A027Z	90915	20	105
1.6	1.587	65	4	06.1998-01.1999	NFZ(TU5JP)		EPBMPN3-A009Z	92952	20	100
1.6	1.587	72	4	10.2000-04.2002	NFT(TU5JP)		EPBMPT4-A001Z	93136	10	117
1.8	1.761	74	4	05.1993-05.2001	LFZ(XU7JP)		EPBMPN3-A035Z	92810	20	100
1.8 16V	1.761	81	4	-11.1998	LFY(XU7JP4)		EPBMPN3-A009Z	92952	20	100
1.8 16V	1.761	81	4	11.1998-	LFY(XU7JP4)		EPBMPN3-A007Z	96754	20	105
1.8 16V	1.761	82	4	-11.1998	LFY(XU7JP4)		EPBMPN3-A009Z	92952	20	100
1.8 16V	1.761	82	4	11.1998-	LFY(XU7JP4)		EPBMPN3-A007Z	96754	20	105
2.0 16V	1.998	97	4	-11.1998	RFV(XU10J4R)		EPBMPN3-A009Z	92952	20	100
2.0 16V	1.998	97	4	11.1998-	RFV(XU10J4R)		EPBMPN3-A007Z	96754	20	105
2.0 16V	1.998	99	4	-11.1998	RFV(XU10J4R)		EPBMPN3-A009Z	92952	20	100
2.0 16V	1.998	99	4	11.1998-	RFV(XU10J4R)		EPBMPN3-A007Z	96754	20	105
2.0 S16	1.998	120	4	-11.1998	RFS(XU10J4RS)		EPBMPN3-A009Z	92952	20	100
2.0 S16	1.998	120	4	11.1998-	RFS(XU10J4RS)		EPBMPN3-A007Z	96754	20	105

307 / 307 SW (3A/C, 3E, 3H)

1.4	1.360	55	4	08.2000-09.2003	KFW(TU3JP)		EPBMPT4-A001Z	93136	10	117
1.4 16V	1.360	65	4	11.2003-07.2007	KFU(ET3J4)		EPBMPT4-A001Z	93136	10	117
1.6 HDi	1.560	66	4	04.2005-03.2009	9HV(DV6TED4B), 9HV(DV6TED4BU), 9HX(DV6ATED4)		EPBBPN3-A001Z	94263	10	240
1.6 HDi 110	1.560	80	4	02.2004-03.2009	9HY(DV6TED4), 9HZ(DV6TED4)		EPBBPN3-A001Z	94263	10	240
1.6 16V	1.587	80	4	08.2000-04.2008	NFU(TU5JP4)		EPBMPT4-A001Z	93136	10	117
2.0 HDi 90	1.997	66	4	08.2000-04.2008	RHY(DW10TD)		EPBBPN3-A001Z	94263	10	240
2.0 HDi 110	1.997	79	4	08.2000-12.2009	RHS(DW10ATED)		EPBBPN3-A001Z	94263	10	240
2.0 16V	1.997	100	4	08.2000-06.2005	RFN(EW10J4)		EPBMPN3-A020Z	96725	20	117
2.0 HDi 135	1.997	100	4	10.2003-04.2008	RHR(DW10BTED4)		EPBBPN3-A001Z	94263	10	240
2.0 16V	1.997	103	4	03.2005-04.2008	RFJ(EW10A)		EPBMPT4-A001Z	93136	10	117
2.0 16V	1.997	103	4	03.2005-04.2008	RFJ(EW10A)		EPBMPN3-A020Z	96725	20	117
2.0 16V	1.997	130	4	06.2005-04.2008	RFK(EW10J4S)		EPBMPT4-A001Z	93136	10	117



MAP



l kW
C
Y
I



Type-N°

Stock-N°

kPa from

kPa to

PEUGEOT

307 CC (3B)

1.6 16V	1.587	80	4	03.2003-04.2009	NFU(TU5JP4)		EPBMPT4-A001Z	93136	10	117
2.0 16V	1.997	100	4	10.2003-06.2005	RFN(EW10J4)		EPBMPN3-A020Z	96725	20	117
2.0 HDi 135	1.997	100	4	06.2005-04.2009	RHR(DW10BTED4)		EPBBPN3-A001Z	94263	10	240
2.0 16V	1.997	103	4	12.2004-04.2009	RFJ(EW10A)		EPBMPT4-A001Z	93136	10	117
2.0 16V	1.997	130	4	10.2003-04.2009	RFK(EW10J4S)		EPBMPT4-A001Z	93136	10	117

308 / 308 SW (4A_, 4C_, 4E_, 4H_)

1.4 16V	1.397	70	4	09.2007-10.2014	8FS(EP3)		EPBMPT4-A006Z	96115		
1.4 16V	1.397	72	4	12.2009-10.2014	8FR(EP3)		EPBMPT4-A006Z	96115		
1.6 HDi	1.560	66	4	09.2007-10.2014	9HX(DV6ATED4)	; Position: Intake Manifold	EPBBPN3-A001Z	94263	10	240
1.6 HDi	1.560	68	4	11.2009-10.2014	9HJ(DV6DTEDM), 9HP(DV6DTED)	; Position: Intake Manifold	EPBMBT4-A003Z	93024	12,9	316,5
1.6 BioFlex	1.587	80	4	04.2008-10.2014	NFU(TU5JP4)	; Position: Intake Manifold	EPBMPT4-A001Z	93136	10	117
1.6 HDi	1.560	80	4	09.2007-10.2014	9HZ(DV6TED4)	; Position: Intake Manifold	EPBBPN3-A001Z	94263	10	240
1.6 Bioflex	1.587	82	4	03.2009-10.2014	NFU(TU5JP4)		EPBMPT4-A001Z	93136	10	117
1.6 HDi	1.560	82	4	12.2009-10.2014	9HR(DV6C)	; Position: Intake Manifold	EPBMBT4-A003Z	93024	12,9	316,5
1.6 16V	1.598	88	4	09.2007-10.2014	5FW(EP6)		EPBMPT4-A006Z	96115		
1.6 16V	1.598	103	4	07.2008-	5FT(EP6DT)		EPBMPT4-A001Z	93136	10	117
1.6 16V	1.598	103	4	09.2007-10.2014	5FT(EP6DT)		EPBBPN3-A024Z	91449	50	350
1.6 16V	1.598	110	4	09.2007-10.2014	5FX(EP6DT)	; Position: Intake Manifold;	EPBBPN3-A024Z	91449	50	350
1.6 16V	1.598	110	4	-07.2010	5FX(EP6DT)	; With Charger Intercooler	EPBBPT4-A016Z	95268	15	260
1.6 16V	1.598	115	4	10.2009-10.2014	5FV(EP6CDT)	;	EPBBPN3-A024Z	91449	50	350
1.6 16V	1.598	115	4	10.2009-10.2014	5FV(EP6CDT)		EPBBPN3-V030Z	94092	50	465
1.6 16V	1.598	128	4	03.2008-10.2014	5FY(EP6DTS)		EPBBPN3-A024Z	91449	50	350
1.6 GTi	1.598	147	4	07.2010-10.2014	EP6CDTX		EPBBPN3-V030Z	94092	50	465
2.0 HDi	1.997	100	4	09.2007-10.2014	RHR(DW10BTED4), RHR(DW10CB)		EPBBPN3-A001Z	94263	10	240
2.0 Bioflex	1.997	103	4	01.2008-12.2012	RFJ(EW10A)	; Position: Intake Manifold	EPBMPT4-A001Z	93136	10	117
2.0 HDi	1.997	103	4	09.2007-10.2014	RHR(DW10BTED4)		EPBBPN3-A001Z	94263	10	240
2.0 HDi	1.997	110	4	04.2011-10.2014	RHE(DW10CTED4)	; Position: Intake Manifold	EPBMBT4-A003Z	93024	12,9	316,5
2.0 HDi	1.997	120	4	06.2009-10.2014	RHH(DW10CTED4)	; Position: Intake Manifold	EPBMBT4-A003Z	93024	12,9	316,5

308 / 308 SW II

1.6 HDi / BlueHDi 115	1.560	85	4	09.2013-	9HC(DV6C)	; Position: Suction Pipe	EPBMBT4-A003Z	93024	12,9	316,5
1.6 THP 125	1.598	92	4	09.2013-	5FA(EP6CDT)		EPBBPN3-V030Z	94092	50	465
1.6 THP 150	1.598	110	4	03.2014-	5GX(EP6FDTMD)		EPBBPN3-V030Z	94092	50	465
1.6	1.598	115	4	09.2013-	5FV(EP6CDT)		EPBBPN3-V030Z	94092	50	465
1.6 THP 163	1.598	120	4	06.2014-	5FM(EP6CDTM)		EPBBPN3-V030Z	94092	50	465
1.6 GT 205	1.598	151	4	06.2014-	5GT(EP6FDTX)		EPBBPN3-V030Z	94092	50	465

308 CC (4B_)

1.6 HDi	1.560	82	4	06.2009-12.2014	9HR(DV6C)	; Position: Intake Manifold	EPBMBT4-A003Z	93024	12,9	316,5
---------	-------	----	---	-----------------	-----------	-----------------------------	---------------	-------	------	-------



MAP



kW
C
Y
I



Type-N°

Stock-N°

kPa from

kPa to

PEUGEOT

308 CC (4B_)

1.6 16V	1.598	88	4	06.2009-12.2014	EP6		EPBMPT4-A006Z	96115		
1.6 16V	1.598	103	4	06.2009-12.2014	5FT(EP6DT)		EPBBPN3-A024Z	91449	50	350
1.6 16V	1.598	110	4	06.2009-12.2014	5FX(EP6DT)	;	EPBBPN3-A024Z	91449	50	350
1.6 16V	1.598	115	4	06.2009-12.2014	5FV(EP6CDT)	;	EPBBPN3-A024Z	91449	50	350
1.6 16V	1.598	115	4	06.2009-12.2014	5FV(EP6CDT)		EPBBPN3-V030Z	94092	50	465
1.6 THP	1.598	147	4	10.2010-12.2014	EP6CDTX		EPBBPN3-V030Z	94092	50	465
2.0 HDi	1.997	100	4	04.2009-12.2014	RHR(DW10BTED4)	; Position: Intake Manifold	EPBBPN3-A001Z	94263	10	240
2.0 HDi	1.997	103	4	04.2009-12.2012	RHF(DW10BTED4)	; Position: Intake Manifold	EPBBPN3-A001Z	94263	10	240
2.0	1.997	103	4	07.2009-12.2014	RFJ(EW10A)	; Position: Intake Manifold	EPBMPT4-A001Z	93136	10	117
2.0 HDi	1.997	120	4	06.2009-12.2014	RHH(DW10CTED4)	; Position: Intake Manifold	EPBMBT4-A003Z	93024	12,9	316,5

309 (3C, 3A, 10C, 10A)

1.9	1.905	80	4	07.1988-12.1993	DDZ(XU9M)		EPBMPN3-A003Z	92477	15	102
-----	-------	----	---	-----------------	-----------	--	---------------	-------	----	-----

4007 (VU_, VV_)

2.2 HDi	2.179	115	4	02.2007-03.2013	4HK(DW12ME5), 4HN(DW12MTED4)		EPBBPN3-A017Z	95311	35	320
---------	-------	-----	---	-----------------	------------------------------	--	---------------	-------	----	-----

405 (15B, 15E)

1.9 Injection	1.905	77	4	07.1987-12.1992	DFZ(XU9J1)		EPBMPN3-A003Z	92477	15	102
1.9	1.905	77	4	10.1988-08.1992	DFZ(XU9J1)		EPBMPN3-A003Z	92477	15	102
1.9	1.905	80	4	06.1987-07.1992	DDZ(XU9M)		EPBMPN3-A003Z	92477	15	102
1.9 4x4	1.905	80	4	07.1988-12.1992	DDZ(XU9M)		EPBMPN3-A003Z	92477	15	102
1.9	1.905	90	4	01.1989-12.1992	D6A(XU9J2)		EPBMPN3-A003Z	92477	15	102

406 (8B, 8E/F, 8C)

1.6	1.580	65	4	11.1995-05.2004	BFZ(XU5JP)		EPBMPN3-A035Z	92810	20	100
1.8	1.761	66	4	-10.1998	LFZ(XU7JB)		EPBMPN3-A009Z	92952	20	100
1.8	1.761	74	4	10.1996-03.1999	LFZ(XU7JP), L6A(XU7JP)		EPBMPN3-A035Z	92810	20	100
1.8 16V	1.761	81	4	11.1995-10.2000	LFY(XU7JP4)		EPBMPN3-A003Z	92477	15	102
1.8 16V	1.749	85	4	10.2000-10.2004	6FZ(EW7J4)		EPBMPN3-A007Z	96754	20	105
1.8 16V	1.749	85	4	10.2000-10.2004	6FZ(EW7J4)		EPBMPN3-A003Z	92477	15	102
2.0 HDi 110	1.997	79	4	08.2001-10.2004	RHZ(DW10ATED), RHS(DW10ATED)	; For vehicles without self-diagnosis system	EPBBPN3-A003Z	91268	10	250
2.0 HDi 110	1.997	79	4	08.2001-10.2004	RHZ(DW10ATED), RHS(DW10ATED)	; For vehicles with self-diagnosis system	EPBBPN3-A006Z	91736	10	240
2.0 HDi 110	1.997	80	4	02.1999-04.2004	RHZ(DW10ATED)	; For vehicles without self-diagnosis system	EPBBPN3-A003Z	91268	10	250
2.0 HDi 110	1.997	80	4	02.1999-04.2004	RHZ(DW10ATED)	; For vehicles with self-diagnosis system	EPBBPN3-A006Z	91736	10	240
2.0 16V	1.998	97	4	-10.1998	RFV(XU10J4R)		EPBMPN3-A009Z	92952	20	100
2.0 16V Coupe	1.998	97	4	03.1997-12.2004	RFV(XU10J4R)		EPBMPN3-A007Z	96754	20	105
2.0 16V Coupe	1.998	99	4	04.1999-09.2004	RFV(XU10J4R)		EPBMPN3-A007Z	96754	20	105
2.0 16V	1.997	100	4	08.2000-12.2004	RFV(XU10J4R), RFN(EW10J4)		EPBMPN3-A007Z	96754	20	105
2.1 TD 12V	2.088	80	4	01.1996-10.2004	P8C(XUD11BTE)		EPBBPN3-A027Z	92471	10	200



MAP



l kW
C
Y
I



Type-N°

Stock-N°

kPa from
kPa to

PEUGEOT

406 (8B, 8E/F, 8C)

2.2 HDi	2.179	98	4	-06.2003	4HX(DW12TED4)		EPBBPN3-A003Z	91268	10	250
2.2 HDi	2.179	98	4	07.2003-	4HX(DW12TED4)		EPBBPN3-A006Z	91736	10	240
2.2	2.230	116	4	07.2000- 12.2004	3FZ(EW12J4)		EPBMPN3-A007Z	96754	20	105
3.0 24V	2.946	140	6	-12.1998	XFZ(ES9J4)		EPBMPN3-A009Z	92952	20	100
3.0 24V	2.946	143	6	05.1997- 06.1999	XFZ(ES9J4)		EPBMPN3-A007Z	96754	20	105
3.0 V6	2.946	152	6	03.2000- 12.2004	XFZ(ES9J4S)		EPBMPN3-A020Z	96725	20	117

407 (6C_, 6D_, 6E_)

1.6 HDi 110	1.560	80	4	05.2004- 12.2010	9HZ(DV6TED4)		EPBBPN3-A001Z	94263	10	240
1.8	1.749	85	4	03.2004- 07.2005	6FZ(EW7J4)		EPBMPN3-A020Z	96725	20	117
1.8 16V	1.749	92	4	08.2005- 12.2010	6FY(EW7A)		EPBMPT4-A001Z	93136	10	117
2.0	1.997	100	4	03.2004- 07.2005	RFN(EW10J4)		EPBMPN3-A020Z	96725	20	117
2.0 HDi 135	1.997	100	4	05.2004- 10.2010	RHR(DW10BTED4)		EPBBPN3-A001Z	94263	10	240
2.0 Bioflex	1.997	103	4	09.2007- 02.2011	RFJ(EW10A)	; Position: Suction Pipe	EPBMPT4-A001Z	93136	10	117
2.0 16V	1.997	103	4	08.2005- 12.2010	RFJ(EW10A)		EPBMPT4-A001Z	93136	10	117
2.0 HDi	1.997	103	4	06.2009- 12.2010	RHF(DW10BTED4)		EPBBPN3-A001Z	94263	10	240
2.0 HDi	1.997	103	4	08.2008- 12.2010	RHR(DW10BTED4)		EPBBPN3-A001Z	94263	10	240
2.0 HDi	1.997	120	4	06.2009- 12.2010	RHH(DW10CTED4)		EPBMBT4-A003Z	93024	12,9	316,5
2.2	2.230	116	4	03.2004- 10.2006	3FZ(EW12J4)	; Position: Intake Manifold	EPBMPN3-A007Z	96754	20	105
2.2 16V	2.230	120	4	08.2005- 12.2010	3FY(EW12J4)		EPBMPT4-A001Z	93136	10	117
2.2 HDi	2.179	120	4	03.2006- 12.2010	4HP(DW12BTED4)		EPBBPN3-A018Z	95753	35	320
2.2 HDi 170	2.179	125	4	03.2006- 12.2010	4HT(DW12BTED4)		EPBBPN3-A018Z	95753	35	320
3.0	2.946	155	6	03.2004- 12.2010	XFV(ES9A)		EPBMPN3-A020Z	96725	20	117

5008 (0U_, 0E_)

1.6 HDi	1.560	80	4	09.2009- 03.2017	9HZ(DV6TED4)		EPBBPN3-A001Z	94263	10	240
1.6 HDi	1.560	82	4	08.2010- 03.2017	9HR(DV6C)		EPBMBT4-A003Z	93024	12,9	316,5
1.6 HDi	1.560	84	4	03.2013- 03.2017	9HD(DV6C)	; Position: Suction Pipe	EPBMBT4-A003Z	93024	12,9	316,5
1.6 16V	1.598	88	4	09.2009- 03.2017	5FS(EP6C), 5FW(EP6)		EPBMPT4-A006Z	96115		
1.6 THP 150	1.598	110	4	02.2012- 03.2017	5FX(EP6DT)		EPBBPN3-A024Z	91449	50	350
1.6 16V	1.598	115	4	09.2009- 03.2017	5FV(EP6CDT)		EPBBPN3-A024Z	91449	50	350
1.6 THP 163	1.598	120	4	02.2012- 03.2017	5GZ(EP6FDT)	;	EPBBPN3-A024Z	91449	50	350
1.6 THP 165	1.598	121	4	02.2012- 03.2017	5GZ(EP6FDT)		EPBBPN3-V030Z	94092	50	465
2.0 HDi 136, BlueHDi 136	1.997	100	4	02.2012- 03.2017	AHV(DW10FD), RHD(DW10CB), RHD(DW10CTED4)	; Position: Suction Pipe	EPBMBT4-A003Z	93024	12,9	316,5
2.0 HDi 150, BlueHDi 150	1.997	110	4	06.2009- 03.2017	RHE(DW10CTED4)		EPBMBT4-A003Z	93024	12,9	316,5
2.0 HDi	1.997	120	4	09.2009- 03.2017	RHD(DW10CTED4)		EPBMBT4-A003Z	93024	12,9	316,5

5008 II

1.6 THP 165	1.598	121	4	01.2017-	5GY(EP6FDTM), 5GZ(EP6FDT)		EPBBPN3-V030Z	94092	50	465
-------------	-------	-----	---	----------	------------------------------	--	---------------	-------	----	-----



MAP



l kW
C
Y
I



Type-N°

Stock-N°

kPa from

kPa to

PEUGEOT

508 I (8D_8E_)

1.6 HDi	1.560	82	4	11.2010-12.2018	9HL(DV6C), 9HR(DV6C)		EPBMBT4-A003Z	93024	12,9	316,5
1.6 HDi	1.560	84	4	02.2012-12.2018	9HD(DV6CTED), 9HL(DV6C), 9HR(DV6C)		EPBMBT4-A003Z	93024	12,9	316,5
1.6 THP	1.598	110	4	11.2010-12.2018	5FE(EP6CDTM), 5FN(EP6CDT)		EPBBPN3-V030Z	94092	50	465
1.6 THP	1.598	115	4	11.2010-12.2018	5FV(EP6CDT)		EPBBPN3-V030Z	94092	50	465
1.6 THP	1.598	120	4	01.2012-12.2018	5GZ(EP6FDT)		EPBBPN3-V030Z	94092	50	465
1.6 THP	1.598	121	4	09.2011-12.2018	5GZ(EP6FDT)		EPBBPN3-V030Z	94092	50	465
2.0 HDi	1.997	103	4	11.2010-12.2018	RHF(DW10BTED4)	; Position: Intake Manifold	EPBBPN3-A001Z	94263	10	240
2.0 HDi	1.997	120	4	11.2010-12.2018	RHH(DW10CTED4)		EPBMBT4-A003Z	93024	12,9	316,5
2.0 HDi Hybrid4 AWC	1.997	120	4	11.2010-12.2018	RHC(DW10CTED4)		EPBMBT4-A003Z	93024	12,9	316,5
2.0 HDi RXH Hybrid4	1.997	120	4	11.2010-12.2018	RHC(DW10CTED4)		EPBMBT4-A003Z	93024	12,9	316,5
2.0 HDi Hybrid4 AWC	1.997	147	4	11.2010-12.2018	RHC(DW10CTED4)	; Position: Suction Pipe	EPBMBT4-A003Z	93024	12,9	316,5
2.2 HDi	2.179	150	4	11.2010-12.2018	4HL(DW12C)		EPBBPN3-A018Z	95753	35	320

605 (6B)

2.1 Turbo Diesel	2.088	80	4	06.1989-09.1999	PHZ(XUD11ATE)		EPBBPN3-A027Z	92471	10	200
3.0 SV 24	2.963	147	6	08.1989-09.1999	UKZ(ZRJ4/Z)		EPBMPN3-A003Z	92477	15	102

607 (9D, 9U)

2.0 HDi	1.997	79	4	03.2001-09.2004	RHS(DW10ATED)		EPBBPN3-A006Z	91736	10	240
2.0 HDi	1.997	80	4	-08.2003	RHZ(DW10ATED)	; RPO <09820	EPBBPN3-A003Z	91268	10	250
2.0 HDi	1.997	80	4	09.2003-	RHZ(DW10ATED)	; RPO >09821	EPBBPN3-A006Z	91736	10	240
2.0	1.997	100	4	02.2000-08.2005	RFN(EW10J4)		EPBMPN3-A020Z	96725	20	117
2.0 HDi	1.997	100	4	09.2005-07.2011	RHR(DW10BTED4)		EPBBPN3-A001Z	94263	10	240
2.2 HDi	2.179	98	4	02.2000-02.2006	4HX(DW12TED4)	; For vehicles without self-diagnosis system	EPBBPN3-A003Z	91268	10	250
2.2 HDi	2.179	98	4	02.2000-02.2006	4HX(DW12TED4)	; For vehicles with self-diagnosis system	EPBBPN3-A006Z	91736	10	240
2.2 HDi	2.179	125	4	05.2006-06.2010	4HT(DW12BTED4)		EPBBPN3-A018Z	95753	35	320
2.2 16V	2.230	116	4	02.2000-08.2005	3FZ(EW12J4)		EPBMPN3-A007Z	96754	20	105
2.2 16V	2.230	120	4	09.2005-06.2010	3FY(EW12J4)		EPBMPN3-A007Z	96754	20	105
3.0 V6 24V	2.946	152	6	02.2000-07.2004	XFV(ES9J4S)		EPBMPN3-A020Z	96725	20	117
3.0 V6 24V	2.946	155	6	03.2004-07.2011	XFV(ES9A), XFX(ES9J4S)		EPBMPN3-A020Z	96725	20	117

806 (221)

1.8	1.761	73	4	07.1995-08.2002	LFW(XU7JP)		EPBMPN3-A002Z	96249	15	100
2.0 HDi	1.997	80	4	08.1999-08.2002	RHZ(DW10ATED)		EPBBPN3-A003Z	91268	10	250
2.0 HDi 16V	1.997	80	4	08.1999-08.2002	RHW(DW10ATED4)		EPBBPN3-A003Z	91268	10	250
2.0	1.998	89	4	06.1994-08.2002	RFU(XU10J2)		EPBMPN3-A002Z	96249	15	100
2.0 16V	1.998	97	4	-12.1998	RFV(XU10J4R)		EPBMPN3-A009Z	92952	20	100
2.0 16V	1.997	100	4	09.2000-08.2002	RFN(EW10J4)		EPBMPN3-A007Z	96754	20	105
2.1 td 12V	2.088	80	4	06.1996-08.1999	P8C(XUD11BTE)		EPBBPN3-A027Z	92471	10	200



MAP



l kW
C
Y
I



Type-N°

Stock-N°

kPa from

kPa to

PEUGEOT

807 (E)

2.0 HDi	1.997	79	4	06.2002-	RHW(DW10ATED4), RHT(DW10ATED4), RHM(DW10ATED4)	; For vehicles without self-diagnosis system	EPBBPN3-A003Z	91268	10	250
2.0 HDi	1.997	79	4	06.2002-	RHW(DW10ATED4), RHT(DW10ATED4), RHM(DW10ATED4)	; For vehicles with self-diagnosis system	EPBBPN3-A006Z	91736	10	240
2.0 HDi	1.997	80	4	04.2004-	RHW(DW10ATED4)	; For vehicles without self-diagnosis system	EPBBPN3-A003Z	91268	10	250
2.0 HDi	1.997	80	4	04.2004-	RHW(DW10ATED4)	; For vehicles with self-diagnosis system	EPBBPN3-A006Z	91736	10	240
2.0 HDi	1.997	88	4	02.2006-	RHK(DW10UTED4)		EPBBPN3-A001Z	94263	10	240
2.0	1.997	100	4	06.2002-	RFN(EW10J4)		EPBMPN3-A020Z	96725	20	117
2.0 HDi	1.997	100	4	06.2006-	RHR(DW10BTED4)	; Position: Intake Manifold	EPBBPN3-A001Z	94263	10	240
2.0 16V	1.997	103	4	09.2005-	RFJ(EW10A)		EPBMPT4-A001Z	93136	10	117
2.0 HDi	1.997	120	4	06.2009-	RHH(DW10CTED4)	; Position: Intake Manifold	EPBMBT4-A003Z	93024	12,9	316,5
2.2 HDi	2.179	94	4	06.2002-	4HW(DW12BTED4)	; For vehicles without self-diagnosis system	EPBBPN3-A003Z	91268	10	250
2.2 HDi	2.179	94	4	06.2002-	4HW(DW12BTED4)	; For vehicles with self-diagnosis system	EPBBPN3-A006Z	91736	10	240
2.2 HDi	2.179	100	4	04.2004-	4HW(DW12TED4)		EPBBPN3-A006Z	91736	10	240
2.2	2.230	116	4	06.2002-	3FZ(EW12J4)	; Position: Intake Manifold	EPBMPN3-A007Z	96754	20	105
2.2 HDi	2.179	120	4	06.2006-	4HR(DW12BTED4)		EPBBPN3-A018Z	95753	35	320
2.2 HDi	2.179	125	4	06.2006-	4HT(DW12BTED4)		EPBBPN3-A018Z	95753	35	320
3.0 V6	2.946	150	6	06.2002-	XFJ(ES9J4S)		EPBMPN3-A020Z	96725	20	117

BIPPER (AA_)

1.3 HDi 75	1.248	55	4	10.2010-	FHZ(F13DTE5)		EPBBPT4-V001Z	92565	11	307
1.4 HDi	1.398	50	4	03.2008-	8HS(DV4TED)		EPBBPN3-A006Z	91736	10	240
1.4	1.360	54	4	02.2008-	KFV(TU3A)		EPBMPT4-A001Z	93136	10	117

BOXER

2.2 HDi 100	2.198	74	4	04.2006-	4HV(P22DTE)		EPBBPT4-A011Z	94601	20	300
2.2 HDi 110	2.198	81	4	03.2011-	4HG(P22DTE)		EPBMPN3-V019Z	93061	10	307,5
2.2 HDi 120	2.198	88	4	04.2006-	4HU(P22DTE)		EPBBPT4-A011Z	94601	20	300
2.2 HDi 130	2.198	96	4	03.2011-	4HH(P22DTE)		EPBMPN3-V019Z	93061	10	307,5
2.2 HDi 150	2.198	110	4	03.2011-	4HJ(P22DTE)		EPBMPN3-V019Z	93061	10	307,5
3.0 HDi 145	2.999	107	4	04.2010-	F1CE3481N(F30DTE)		EPBBPT4-V001Z	92565	11	307
3.0 HDi 160	2.999	116	4	04.2006-	F1CE0481D(F30DT)		EPBBPT4-V001Z	92565	11	307
3.0 HDi 175	2.999	130	4	03.2011-	F1CE3481E(F30DTE)		EPBBPT4-V001Z	92565	11	307

BOXER (230_, ZCT_)

2.0 HDi	1.997	62	4	08.2001- 04.2002	RHV(DW10UTD)		EPBMPN3-A002Z	96249	15	100
2.0 i	1.998	80	4	03.1994- 04.2002	RFW(XU10J2)		EPBMPN3-A002Z	96249	15	100
2.0 i 4x4	1.998	80	4	08.1996- 04.2002	RFW(XU10J2)		EPBMPN3-A002Z	96249	15	100
2.8 D	2.798	64	4	01.1999- 02.2002	8140.63(F28D)		EPBMPN3-A002Z	96249	15	100
2.8 HDi	2.798	93	4	10.2000- 11.2001	8140.43S(F28DTCR)	; Position: Fuel Line	EPBMPN3-A002Z	96249	15	100



MAP



l kW
C
Y
I



Type-N°

Stock-N°

kPa from

kPa to

PEUGEOT

BOXER (230_, ZCT_)

2.8 HDi	2.798	94	4	11.2000-04.2002	8140.43S(F28DTCR)	; Position: Fuel Line	EPBMPN3-A002Z	96249	15	100
2.8 HDi 4x4	2.798	94	4	10.2000-04.2002	8140.43S(F28DTCR)	; Position: Fuel Line	EPBMPN3-A002Z	96249	15	100

BOXER (244, Z_)

2.0 HDi	1.997	62	4	-12.2004	RHV(DW10TD), RHV(DW10UTD)		EPBMPN3-A002Z	96249	15	100
2.0	1.998	81	4	04.2002-	RFL(XU10J2U)		EPBMPN3-A002Z	96249	15	100
2.2 HDi	2.179	74	4	04.2002-	4HY(DW12UTED)		EPBMPN3-A002Z	96249	15	100

EXPERT

1.6 HDi 90 16V	1.560	66	4	01.2007-	9HU(DV6UTED4)		EPBBPN3-A001Z	94263	10	240
2.0 HDi 120	1.997	88	4	01.2007-	RHK(DW10UTED4)		EPBBPN3-A001Z	94263	10	240
2.0 HDi 140	1.997	100	4	01.2007-	RHR(DW10BTED4)	; Position: Intake Manifold	EPBBPN3-A001Z	94263	10	240

EXPERT (222, 223, 224_)

1.8	1.761	74	4	10.1996-09.2000	LFZ(XU7JP)		EPBMPN3-A002Z	96249	15	100
2.0 HDi	1.997	69	4	-06.2003	RHX(DW10BTED)		EPBBPN3-A003Z	91268	10	250
2.0 HDi	1.997	69	4	06.2003-	RHX(DW10BTED)		EPBBPN3-A006Z	91736	10	240
2.0 HDi	1.997	80	4	-06.2003	RHZ(DW10BTED+)		EPBBPN3-A003Z	91268	10	250
2.0 HDi 16V	1.997	80	4	-06.2003	RHW(DW10ATED4)		EPBBPN3-A003Z	91268	10	250
2.0 HDi	1.997	80	4	06.2003-	RHZ(DW10BTED+)		EPBBPN3-A006Z	91736	10	240
2.0 HDi 16V	1.997	80	4	06.2003-	RHW(DW10ATED4)		EPBBPN3-A006Z	91736	10	240
2.0 HDi	1.997	80	4	07.2000-12.2006	RHZ(DW10ATED), RHZ(DW10BTED)		EPBBPN3-A003Z	91268	10	250
2.0	1.997	100	4	07.2000-12.2006	RFN(EW10J4)		EPBMPN3-A007Z	96754	20	105

EXPERT (VF3A_, VF3U_, VF3X_)

1.6 HDi 90 16V	1.560	66	4	01.2007-	9HU(DV6UTED4)		EPBBPN3-A001Z	94263	10	240
1.6 HDi 90 8V	1.560	66	4	01.2007-	9HM(DV6UC)		EPBMBT4-A003Z	93024	12,9	316,5
2.0 HDi 100	1.997	72	4	03.2011-03.2016	AHY(DW10CE)	; Position: Suction Pipe	EPBMBT4-A003Z	93024	12,9	316,5
2.0 HDi 120	1.997	88	4	01.2007-	RHK(DW10UTED4)		EPBBPN3-A001Z	94263	10	240
2.0 HDi 120 4x4	1.997	88	4	01.2007-	RHK(DW10UTED4)		EPBBPN3-A001Z	94263	10	240
2.0 HDi 130	1.997	94	4	03.2011-	AHZ(DW10CD)		EPBMBT4-A003Z	93024	12,9	316,5
2.0 HDi 130 4x4	1.997	94	4	03.2011-	AHZ(DW10CD)	; Position: Suction Pipe	EPBMBT4-A003Z	93024	12,9	316,5
2.0 HDi 140	1.997	100	4	01.2007-	RHR(DW10BTED4)	; Position: Intake Manifold	EPBBPN3-A001Z	94263	10	240
2.0 16V	1.997	103	4	01.2007-	RFH(EW10A), RFJ(EW10A)		EPBMPT4-A001Z	93136	10	117
2.0 HDi 165	1.997	120	4	09.2009-	RHH(DW10CTED4)		EPBMBT4-A003Z	93024	12,9	316,5

PARTNER

1.6 HDi	1.560	55	4	04.2008-	9HT(DV6BTED4), 9HT(DV6BUTED4), 9HW(DV6BTED4)		EPBBPN3-A001Z	94263	10	240
1.6 Hdi, BlueHdi 75	1.560	55	4	07.2011-	9HK(DV6ETEDM), 9HN(DV6ETED), BHW(DV6FE)	; Position: Suction Pipe	EPBMBT4-A003Z	93024	12,9	316,5
1.6 HDi 16V	1.560	66	4	04.2008-	9HS(DV6TED4BU), 9HV(DV6TED4B), 9HV(DV6TED4BU), 9HX(DV6AUTED4)		EPBBPN3-A001Z	94263	10	240
1.6 HDi	1.560	66	4	12.2011-	9HF(DV6DTED)	; Position: Suction Pipe	EPBMBT4-A003Z	93024	12,9	316,5



MAP



l kW
C
Y
I



Type-N°

Stock-N°

kPa from
kPa to

PEUGEOT

PARTNER

1.6 HDi 90	1.560	68	4	04.2010-	9HJ(DV6DTEDM), 9HP(DV6DTEd)		EPBMBT4-A003Z	93024	12,9	316,5
1.6 HDi	1.560	80	4	04.2008-	9HZ(DV6TED4)		EPBBPN3-A001Z	94263	10	240
1.6 HDi	1.560	82	4	08.2010-	9HL(DV6C)		EPBBPN3-A001Z	94263	10	240
1.6 HDi	1.560	82	4	08.2010-	9HL(DV6C)		EPBMBT4-A003Z	93024	12,9	316,5
1.6 HDi	1.560	84	4	03.2013-	9HL(DV6C)		EPBMBT4-A003Z	93024	12,9	316,5
1.6 VTi	1.587	66	4	04.2008-	NFR(TU5JP4B)		EPBMPT4-A001Z	93136	10	117
1.6 VTi	1.587	80	4	04.2008-	NFU(TU5JP4)		EPBMPT4-A001Z	93136	10	117
1.6 VTi	1.598	88	4	-07.2010	5FS(EP6C)	; Org. No. to: 12294	EPBMPT4-A006Z	96115		

PARTNER (5_, G_)

1.1	1.124	44	4	06.1996- 10.2002	HDZ(TU1M), HFx(TU1JP)		EPBMPT4-A001Z	93136	10	117
1.4 BiFuel	1.360	55	4	04.2003- 10.2006	KFW(TU3JP)		EPBMPN3-A003Z	92477	15	102
1.4 BiFuel	1.360	55	4	04.2003- 10.2006	KFW(TU3JP)		EPBMPT4-A001Z	93136	10	117
1.4	1.360	55	4	-11.1998	KFW(TU3A), KFW(TU3JP), KFX(TU3JP)	; RPO <08056	EPBMPN3-A009Z	92952	20	100
1.4	1.360	55	4	11.1998-	KFX(TU3JP)	; Liquefied Petroleum Gas (LPG)	EPBMPN3-A007Z	96754	20	105
1.4	1.360	55	4	06.1996- 12.2015	KFW(TU3A), KFW(TU3JP), KFX(TU3JP)		EPBMPN3-A003Z	92477	15	102
1.4	1.360	55	4	06.1996- 12.2015	KFW(TU3A), KFW(TU3JP), KFX(TU3JP)		EPBMPT4-A001Z	93136	10	117
1.6 HDi 75	1.560	55	4	08.2005- 07.2008	9HW(DV6BTED4)		EPBBPN3-A001Z	94263	10	240
1.6 HDi 90	1.560	66	4	08.2005- 12.2015	9HX(DV6ATED4)		EPBBPN3-A001Z	94263	10	240
1.6 16V	1.587	80	4	07.2001- 03.2008	NFU(TU5JP4)		EPBMPT4-A001Z	93136	10	117
1.8	1.761	66	4	-12.1998	LFX(XU7JB)		EPBMPN3-A009Z	92952	20	100

RCZ

1.6 THP 150	1.598	110	4	03.2011- 12.2015	5FE(EP6CDTMD)		EPBBPN3-V030Z	94092	50	465
1.6 16V	1.598	115	4	03.2010- 12.2015	5FV(EP6CDT)	; 6-Speed	EPBBPN3-A024Z	91449	50	350
1.6 16V	1.598	115	4	03.2010- 12.2015	5FV(EP6CDT)		EPBBPN3-V030Z	94092	50	465
1.6 16V	1.598	147	4	06.2010- 12.2015	EP6CDTX		EPBBPN3-V030Z	94092	50	465
1.6 16V	1.598	150	4	06.2010- 12.2015	EP6CDTX		EPBBPN3-V030Z	94092	50	465
2.0 HDi	1.997	120	4	03.2010- 12.2015	RHH(DW10CTED4)		EPBMBT4-A003Z	93024	12,9	316,5

PORSCHE

911 (996)

3.6 Turbo 4	3.600	309	6	06.2000- 08.2005	M96.70		EPBBPT4-V010Z	91257	20	250
3.6 Turbo 4S	3.600	331	6	02.2003- 08.2005	M96.70		EPBBPT4-V010Z	91257	20	250
3.6 S	3.600	331	6	08.2004- 08.2005	M96.70		EPBBPT4-V010Z	91257	20	250
3.6 GT2	3.600	340	6	04.2001- 08.2005	M96.70		EPBBPT4-V010Z	91257	20	250
3.6 GT2	3.600	355	6	10.2003- 08.2005	M96.70		EPBBPT4-V010Z	91257	20	250

911 (997)

3.6 Turbo	3.600	353	6	03.2006- 12.2009	M97.70		EPBBPT4-V010Z	91257	20	250
-----------	-------	-----	---	---------------------	--------	--	---------------	-------	----	-----



MAP

 kW
C
Y
I

Type-N°

Stock-N°

kPa from

kPa to

PORSCHE
911 (997)

3.6 GT 2	3.600	390	6	09.2007-12.2012	M97.70S		EPBBPT4-V010Z	91257	20	250
3.6 GT2 RS	3.600	456	6	05.2010-12.2012	M97.70		EPBBPT4-V010Z	91257	20	250

CAYENNE (92A)

3.0 Diesel	2.967	155	6	06.2010-	MCR.CB, MCV.VC		EPBBPT4-V002Z	95912	20	300
3.0 Diesel	2.967	176	6	06.2010-	M05.9E, MCN.RB		EPBBPT4-V002Z	95912	20	300
3.0 Diesel	2.967	180	6	06.2011-	MCR.C, MCR.CA		EPBBPT4-V002Z	95912	20	300
3.0 Diesel	2.967	184	6	08.2014-	MCV.VB		EPBBPT4-V002Z	95912	20	300
3.0 Diesel	2.967	193	6	10.2014-	MCV.VA		EPBBPT4-V002Z	95912	20	300
4.2 S Diesel	4.134	281	8	10.2012-	MCU.DB		EPBBPT4-V002Z	95912	20	300
4.2 S Diesel	4.134	283	8	10.2014-	MCU.DC		EPBBPT4-V002Z	95912	20	300
3.0 S E-Hybrid	2.995	245	6	06.2010-	M06.EC, MCG.FA, MCG.EA		EPBMPT4-V008Z	96201	10	117
3.0 S E-Hybrid	2.995	306	6	10.2014-	M06.EC	; Position: Throttle Housing	EPBMPT4-V008Z	96201	10	117
3.0 S E-Hybrid	2.995	306	6	10.2014-	MCG.EA, MCG.FA		EPBMPT4-V008Z	96201	10	117

CAYENNE (9PA)

3.0 TDI	2.967	176	6	02.2009-09.2010	M05.9D		EPBBPT4-V002Z	95912	20	300
Turbo 4.5	4.511	331	8	09.2002-09.2007	M48.50		EPBBPT4-V010Z	91257	20	250
Turbo S 4.5	4.511	368	8	01.2004-09.2007	M48.50S		EPBBPT4-V010Z	91257	20	250
Turbo S 4.5	4.511	383	8	03.2006-09.2007	M48.50T		EPBBPT4-V010Z	91257	20	250

MACAN (95B)

2.0	1.984	185	4	10.2015-	DLHB, MCY.NB, MCY.PA		EPBBPT4-V002Z	95912	20	300
3.0 S Diesel	2.967	155	6	02.2014-09.2018	MCT.BB		EPBBPT4-V002Z	95912	20	300
3.0 S Diesel	2.967	184	6	02.2014-09.2018	MCT.BC		EPBBPT4-V002Z	95912	20	300
3.0 S Diesel	2.967	190	6	02.2014-09.2018	MCT.BA		EPBBPT4-V002Z	95912	20	300

PANAMERA (970)

3.0 D	2.967	155	6	08.2011-07.2013	MCR.CB		EPBBPT4-V002Z	95912	20	300
3.0 D	2.967	184	6	08.2011-07.2013	MCR.CC		EPBBPT4-V002Z	95912	20	300
3.0 S E-Hybrid	2.995	279	6	03.2011-07.2013	MCG.FA, MCG.EA		EPBMPT4-V008Z	96201	10	117
3.0 S E-Hybrid	2.995	306	6	07.2013-10.2016	MCG.FA, MCG.EA		EPBMPT4-V008Z	96201	10	117

PROTON
GEN 2 (CM_)

1.3	1.332	70	4	06.2004-12.2009	S4PE		EPBMPT4-V003Z	93266	10	118
1.6	1.597	82	4	06.2004-	S4PH		EPBMPT4-V003Z	93266	10	118

PUCH
G-MODELL (W463)

G 300 Turbodiesel	2.996	130	6	01.1996-11.2000	OM606.964		EPBBPN3-A009Z	96930	50	250
G 500	4.966	218	8	12.1997-11.2000	M113.962		EPBMPN3-A004Z	90833	10	120
G 55 AMG	5.439	260	8	04.1999-03.2001	M113.982		EPBMPN3-A004Z	90833	10	120



MAP
 l kW
 C
 Y
 I

Type-N°

Stock-N°

kPa from
kPa to**RENAULT****19 (L53_, B/C53_, D53_, 853_)**

1.2	1.171	44	4	05.1992-09.1994	E7F730		EPBMPN3-A003Z	92477	15	102
1.4	1.397	43	4	04.1992-12.1995	C2J772, C3J710		EPBMPN3-A003Z	92477	15	102
1.4	1.397	44	4	05.1992-09.1994	C1J742, C2J772, C3J710		EPBMPN3-A003Z	92477	15	102
1.4	1.390	55	4	01.1992-12.1995	E7J742		EPBMPN3-A003Z	92477	15	102
1.4	1.390	57	4	10.1994-11.1995	E6J700		EPBMPN3-A003Z	92477	15	102
1.4	1.390	59	4	01.1992-12.1995	E6J700, E7J706		EPBMPN3-A003Z	92477	15	102
1.7	1.721	54	4	04.1992-12.1995	F3N740, F3N741		EPBMPN3-A003Z	92477	15	102
1.7	1.721	55	4	07.1991-04.1992	F2N724		EPBMPN3-A003Z	92477	15	102
1.7	1.721	55	4	05.1992-11.1995	F3N740, F3N741		EPBMPN3-A003Z	92477	15	102
1.7	1.721	66	4	04.1992-12.1995	F3N742, F3N743		EPBMPN3-A003Z	92477	15	102
1.7	1.721	68	4	09.1988-08.1995	F2N720, F2N721		EPBMPN3-A003Z	92477	15	102
1.7	1.721	70	4	07.1991-04.1992	F3N742(07.91-04.92), F3N743(07.91-04.92)		EPBMPN3-A003Z	92477	15	102
1.7	1.721	79	4	08.1988-12.1992	F3N746		EPBMPN3-A003Z	92477	15	102
1.8	1.794	65	4	04.1992-06.1996	F3P704, F3P705, F3P706, F3P707, F3P708, F3P760		EPBMPN3-A003Z	92477	15	102
1.8	1.794	66	4	04.1992-06.1996	F3P706, F3P760		EPBMPN3-A003Z	92477	15	102
1.8	1.794	67	4	05.1992-09.1994	F3P765		EPBMPN3-A003Z	92477	15	102
1.8	1.794	79	4	05.1992-06.1996	F3P682, F3P700, F3P706, F3P764, F3P765		EPBMPN3-A003Z	92477	15	102
1.8	1.794	81	4	04.1992-05.1994	F3P700		EPBMPN3-A003Z	92477	15	102
1.8 16V	1.764	99	4	10.1989-06.1996	F7P704		EPBMPN3-A003Z	92477	15	102
1.8 16V	1.764	101	4	07.1991-04.1992	F7P700, F7P704		EPBMPN3-A003Z	92477	15	102

21 (B48_, K48_, L48_)

1.7 Cat	1.721	54	4	05.1988-06.1993	F3N726		EPBMPN3-A003Z	92477	15	102
1.7	1.721	54	4	07.1986-02.1994	F2N750, F3N726		EPBMPN3-A003Z	92477	15	102
1.7	1.721	55	4	03.1986-05.1993	F2N712, F3N726		EPBMPN3-A003Z	92477	15	102
1.7	1.721	66	4	09.1989-06.1994	F3N722, F3N723		EPBMPN3-A003Z	92477	15	102
1.7	1.721	69	4	03.1986-02.1994	F3N722, F3N723		EPBMPN3-A003Z	92477	15	102
2.0	1.995	85	4	03.1986-12.1988	J7R750, J7R751		EPBMPN3-A003Z	92477	15	102
2.0	1.995	86	4	04.1986-06.1992	J7R750, J7R751		EPBMPN3-A003Z	92477	15	102
2.0	1.995	88	4	03.1986-12.1993	J7R746, J7R747		EPBMPN3-A003Z	92477	15	102
2.0	1.995	99	4	02.1990-06.1994	J7R740		EPBMPN3-A003Z	92477	15	102
2.0 4x4	1.995	99	4	12.1989-02.1994	J7R740		EPBMPN3-A003Z	92477	15	102
2.0 Turbo	1.995	119	4	02.1990-10.1992	J7R756		EPBMPN3-A033Z	96422	20	200
2.0 Turbo 4x4	1.995	119	4	02.1990-10.1992	J7R756		EPBMPN3-A033Z	96422	20	200
2.0 Turbo	1.995	129	4	04.1987-03.1990	J7R752		EPBMPN3-A033Z	96422	20	200
2.0 Turbo 4x4	1.995	129	4	08.1989-10.1993	J7R752		EPBMPN3-A033Z	96422	20	200
2.2	2.165	79	4	06.1986-06.1994	J7T754, J7T755		EPBMPN3-A003Z	92477	15	102















RENAULT





21 (B48_, K48_, L48_)

2.2 4x4	2.165	79	4	06.1986-06.1994	J7T754, J7T755		EPBMPN3-A003Z	92477	15	102
---------	-------	----	---	-----------------	----------------	---	---------------	-------	----	-----

25 (B29_)

2.0	1.995	88	4	03.1987-12.1993	J7R722, J7R723		EPBMPN3-A003Z	92477	15	102
2.0 12V	1.995	99	4	06.1989-12.1992	J7R726		EPBMPN3-A003Z	92477	15	102
2.0 12V	1.995	103	4	06.1988-12.1993	J7R720, J7R721		EPBMPN3-A003Z	92477	15	102
2.2	2.165	76	4	11.1985-03.1989	J7T708, J7T732		EPBMPN3-A003Z	92477	15	102
2.2	2.165	79	4	09.1986-12.1992	J7T708, J7T732, J7T733		EPBMPN3-A003Z	92477	15	102
2.2	2.165	89	4	04.1984-12.1989	J7T706, J7T707, J7T714, J7T715		EPBMPN3-A003Z	92477	15	102
2.2	2.165	91	4	04.1984-12.1989	J7T730, J7T731		EPBMPN3-A003Z	92477	15	102
2.4 V6 Turbo	2.458	133	6	10.1984-05.1990	Z7U702		EPBMPN3-A033Z	96422	20	200
2.5 V6 Turbo	2.458	151	6	01.1990-12.1992	Z7U700		EPBMPN3-A033Z	96422	20	200
2.8 V6 Injection	2.849	100	6	06.1986-02.1988	Z7W702		EPBMPN3-A003Z	92477	15	102
2.8 V6 Injection	2.849	110	6	06.1987-12.1992	Z7W706, Z7W707, Z7W709		EPBMPN3-A003Z	92477	15	102
2.8 V6	2.849	115	6	06.1987-02.1990	Z7W700		EPBMPN3-A003Z	92477	15	102

AVANTIME (DEO_)

2.0 16V Turbo	1.998	120	4	11.2001-05.2003	F4R760		EPBMPN3-V013Z	94788	15	255
2.2 dCi	2.188	110	4	05.2002-05.2003	G9T712		EPBMBN3-V001Z	92099	20	256
3.0 V6	2.946	152	6	09.2001-05.2003	L7X720, L7X721, L7X722		EPBMPN3-A020Z	96725	20	117
3.0 V6	2.946	152	6	09.2001-05.2003	L7X720, L7X721, L7X722		EPBMPN3-V001Z	90037	20	100

CLIO I (B/C57_, 5/357_, S57_)

1.2	1.171	40	4	01.1991-06.1996	E7F706		EPBMPN3-A003Z	92477	15	102
1.2	1.239	40	4	01.1996-12.1996	C3G720		EPBMPN3-A003Z	92477	15	102
1.2	1.149	40	4	01.1996-09.1998	D7F730		EPBMPN3-A003Z	92477	15	102
1.2	1.171	43	4	05.1990-09.1998	E7F700, E7F708, E7F750		EPBMPN3-A003Z	92477	15	102
1.2	1.149	43	4	01.1996-09.1998	D7F730		EPBMPN3-A003Z	92477	15	102
1.2	1.171	44	4	05.1990-03.1996	E5F710		EPBMPN3-A003Z	92477	15	102
1.4	1.390	55	4	01.1991-09.1998	E6J718, E7J756, E7J757		EPBMPN3-A003Z	92477	15	102
1.4	1.390	58	4	01.1991-09.1998	E7J601, E7J718, E7J719, E7J754		EPBMPN3-A003Z	92477	15	102
1.4	1.390	59	4	01.1991-09.1998	E7J710, E7J711		EPBMPN3-A003Z	92477	15	102
1.8	1.794	65	4	01.1991-09.1998	F3P710, F3P714		EPBMPN3-A003Z	92477	15	102
1.8	1.783	66	4	08.1990-09.1998	F3P754, F3P755		EPBMPN3-A003Z	92477	15	102
1.8	1.794	70	4	01.1991-09.1998	F3P710		EPBMPN3-A003Z	92477	15	102
1.8 Rsi	1.783	79	4	08.1995-09.1998	F3P758		EPBMPN3-A003Z	92477	15	102
1.8 Rsi	1.794	80	4	01.1993-08.1995	F3P712		EPBMPN3-A003Z	92477	15	102
1.8 16V	1.764	99	4	01.1991-03.1996	F7P722		EPBMPN3-A003Z	92477	15	102
Williams	1.998	108	4	01.1994-09.1998	F7R700		EPBMPN3-A003Z	92477	15	102

MAP

 kW
C
Y
I

Type-N°

Stock-N°

 kPa from
kPa to

RENAULT
CLIO II (BB_, CB_, SB0/1/2_)

1.2	1.149	43	4	-10.1999	D7F710, D7F720, D7F722, D7F726, D7F746, D7F764, D7F766		EPBMPN3-A003Z	92477	15	102
1.2	1.149	43	4	11.1999-	D7F710, D7F720, D7F722, D7F726, D7F746, D7F764, D7F766		EPBMPN3-V001Z	90037	20	100
1.2 LPG	1.149	44	4	-10.1999	D7F722		EPBMPN3-A003Z	92477	15	102
1.2 LPG	1.149	44	4	11.1999-	D7F722		EPBMPN3-V001Z	90037	20	100
1.2	1.149	44	4	03.1999-10.2003	D7F722, D7F726, D7F746		EPBMPN3-A003Z	92477	15	102
1.2 16V	1.149	55	4	06.2001-	D4F706, D4F712, D4F714, D4F722, D4F728		EPBMPN3-V001Z	90037	20	100
1.4	1.390	55	4	09.1998-05.2005	E7J634, E7J635, E7J780, K7J700		EPBMPN3-A003Z	92477	15	102
1.4 16V	1.390	70	4	10.1999-09.2004	K4J712, K4J713		EPBMPN3-V001Z	90037	20	100
1.4 16V	1.390	72	4	02.2000-07.2008	K4J710, K4J711, K4J712, K4J713, K4J715		EPBMPN3-V001Z	90037	20	100
1.5 dCi	1.461	42	4	06.2001-12.2006	K9K704		EPBBPN3-V008Z	90842	20	250
1.5 dCi	1.461	42	4	06.2001-12.2006	K9K704		EPBBPN3-V014Z	96895	20	250
1.5 dCi	1.461	47	4	06.2005-	K9K740		EPBBPN3-V014Z	96895	20	250
1.5 dCi	1.461	48	4	12.2002-10.2007	K9K700, K9K704		EPBBPN3-V014Z	96895	20	250
1.5 dCi	1.461	48	4	06.2001-	K9K700, K9K704		EPBBPN3-V008Z	90842	20	250
1.5 dCi	1.461	50	4	08.2004-	K9K700		EPBBPN3-V008Z	90842	20	250
1.5 dCi	1.461	50	4	08.2004-	K9K700, K9K714		EPBBPN3-V014Z	96895	20	250
1.5 dCi	1.461	59	4	06.2001-10.2004	K9K702		EPBBPN3-V008Z	90842	20	250
1.5 dCi	1.461	59	4	06.2001-10.2004	K9K702		EPBBPN3-V014Z	96895	20	250
1.5 dCi	1.461	60	4	06.2001-	K9K702		EPBBPN3-V008Z	90842	20	250
1.5 dCi	1.461	60	4	11.2003-	K9K702, K9K710, K9K716		EPBBPN3-V014Z	96895	20	250
1.5 dCi	1.461	62	4	02.2007-06.2009	K9K718		EPBBPN3-V014Z	96895	20	250
1.5 dCi	1.461	74	4	01.2004-	K9K712		EPBMPT4-V029Z	90509	12,7	255,3
1.6	1.598	66	4	09.1998-05.2005	K7M744, K7M745, K7M746		EPBMPN3-A003Z	92477	15	102
1.6 16V	1.598	79	4	09.1998-	K4M708, K4M740, K4M742, K4M743, K4M744, K4M745, K4M748		EPBMPN3-V001Z	90037	20	100
2.0 16V Sport	1.998	124	4	02.2000-	F4R730, F4R736		EPBMPN3-V001Z	90037	20	100
3.0 V6 Sport	2.946	166	6	11.2000-12.2002	L7X760		EPBMPN3-A020Z	96725	20	117
3.0 V6 Sport	2.946	166	6	11.2000-12.2002	L7X760		EPBMPN3-V001Z	90037	20	100
3.0 V6 Sport	2.946	187	6	12.2002-	L7X762		EPBMPN3-A020Z	96725	20	117
3.0 V6 Sport	2.946	187	6	12.2002-	L7X762		EPBMPN3-V001Z	90037	20	100
CLIO III (BR0/1,CRO/1,KRO/1, KR0/1_)										
1.2 16V	1.149	48	4	06.2005-	D4F740		EPBMPN3-V001Z	90037	20	100
1.2 16V Hi-Flex	1.149	55	4	07.2008-	D4F740		EPBBPN3-V019Z	95201	20	250
1.2 16V Hi-Flex	1.149	55	4	07.2008-	D4F740		EPBMPN3-V001Z	90037	20	100



MAP
 C
 kW
 Y
 I

Type-N°

Stock-N°

kPa from

kPa to

RENAULT**CLIO III (BR0/1,CR0/1,KR0/1, KR0/1_)**

1.2 16V	1.149	55	4	06.2005-	D4F706, D4F740, D4F764		EPBMPN3-V001Z	90037	20	100
1.2 16V	1.149	58	4	06.2005-	D4F764		EPBMPN3-V001Z	90037	20	100
1.2 16V	1.149	74	4	-08.2011	D4F784		EPBMBN3-V001Z	92099	20	256
1.2 16V	1.149	74	4	05.2007-	D4F784		EPBBPN3-V019Z	95201	20	250
1.2 16V	1.149	76	4	-07.2011	D4F786		EPBBPN3-V019Z	95201	20	250
1.2 16V	1.149	76	4	03.2010-	D4F786		EPBMBN3-V001Z	92099	20	256
1.4 16V	1.390	72	4	06.2005-	K4J780		EPBMPN3-V001Z	90037	20	100
1.5 dCi	1.461	47	4	06.2005-	K9K752		EPBBPN3-V007Z	97073	20	300
1.5 dCi	1.461	47	4	06.2005-	K9K752		EPBBPN3-V014Z	96895	20	250
1.5 dCi	1.461	48	4	02.2010-	K9K752		EPBBPN3-V007Z	97073	20	300
1.5 dCi	1.461	48	4	05.2005-	K9K752		EPBMPN3-V001Z	90037	20	100
1.5 dCi	1.461	48	4	05.2005-	K9K752		EPBBPN3-V014Z	96895	20	250
1.5 dCi	1.461	50	4	06.2005-	K9K714, K9K768		EPBBPN3-V007Z	97073	20	300
1.5 dCi	1.461	55	4	08.2010-	K9K770		EPBBPN3-V007Z	97073	20	300
1.5 dCi	1.461	63	4	06.2005-	K9K766		EPBBPN3-V007Z	97073	20	300
1.5 dCi	1.461	65	4	08.2010-	K9K766, K9K770, K9K772		EPBBPN3-V007Z	97073	20	300
1.5 dCi	1.461	76	4	06.2005-	K9K772		EPBBPN3-V007Z	97073	20	300
1.5 dCi	1.461	78	4	06.2005-	K9K764, K9K774		EPBBPN3-V007Z	97073	20	300
1.6 16V	1.598	65	4	06.2005- 10.2007	K4M804		EPBMPN3-V001Z	90037	20	100
1.6 16V	1.598	82	4	06.2005-	K4M800, K4M801		EPBMPN3-V001Z	90037	20	100
1.6 16V	1.598	94	4	11.2008-	K4M862		EPBMPN3-V001Z	90037	20	100
2.0 16V	1.997	102	4	09.2006-	M4R700, M4R701		EPBMPN3-V001Z	90037	20	100
2.0 16V Sport	1.998	145	4	02.2006-	F4R830, F4R832		EPBMPN3-V001Z	90037	20	100

CLIO IV (BH_, KH_)

1.6 RS	1.618	147	4	03.2013-	M5M400, M5M401, M5M450		EPBBPN3-V007Z	97073	20	300
--------	-------	-----	---	----------	---------------------------	--	---------------	-------	----	-----

ESPACE I (J11_)

2.0 i	1.995	87	4	01.1989- 12.1990	J7R760		EPBMPN3-A003Z	92477	15	102
2.0 i Quadra	1.995	87	4	03.1988- 12.1992	J7R760		EPBMPN3-A003Z	92477	15	102

ESPACE II (J/S63_)

2.0	1.995	76	4	01.1991- 10.1996	J7R768		EPBMPN3-A003Z	92477	15	102
2.2	2.165	79	4	01.1991- 10.1996	J7T772, J7T773, J7T776		EPBMPN3-A003Z	92477	15	102
2.2 4x4	2.165	79	4	03.1991- 12.1996	J7T772, J7T773		EPBMPN3-A003Z	92477	15	102
2.8 V6	2.849	110	6	01.1991- 10.1996	Z7W712, Z7W713, Z7W717		EPBMPN3-A003Z	92477	15	102

ESPACE III (JEO_)

2.0	1.998	84	4	11.1996- 10.2000	F3R728, F3R729, F3R742, F3R768, F3R769		EPBMPN3-A003Z	92477	15	102
2.0	1.998	102	4	09.2001- 10.2002	F4R700, F4R701		EPBMPN3-V001Z	90037	20	100
2.0 16V	1.998	103	4	10.1998- 10.2002	F4R700, F4R701		EPBMPN3-V001Z	90037	20	100



MAP



l kW
C
Y
I



Type-N°

Stock-N°

kPa from
kPa to

RENAULT

ESPACE III (JEO_)

2.2 12V TD	2.188	83	4	11.1996-10.2000	G8T714, G8T716, G8T760		EPBMPN3-A003Z	92477	15	102
2.2 D	2.188	84	4	11.1997-01.2000	G8T716		EPBMPN3-A003Z	92477	15	102
2.2 dCi	2.188	85	4	07.2000-10.2002	G9T710	; OE 7700106886	EPBMPN3-V013Z	94788	15	255
2.2 dCi	2.188	85	4	07.2000-10.2002	G9T710		EPBMBN3-V001Z	92099	20	256
2.2 dCi	2.188	95	4	10.2000-10.2002	G9T642, G9T710	; OE 7700106886	EPBMPN3-V013Z	94788	15	255
2.2 dCi	2.188	95	4	10.2000-10.2002	G9T710		EPBMBN3-V001Z	92099	20	256
3.0 V6 24V	2.946	140	6	-12.1998	L7X727		EPBMPN3-A009Z	92952	20	100
3.0 V6 24V	2.946	140	6	01.1999-	L7X727		EPBMPN3-A007Z	96754	20	105
3.0	2.963	123	6	11.1996-10.1998	Z7X775		EPBMPN3-A003Z	92477	15	102

ESPACE IV (JK0/1_)

1.9 dCi	1.870	85	4	04.2003-02.2005	F9Q820	; Position: Intake Manifold	EPBMBN3-V001Z	92099	20	256
1.9 dCi	1.870	85	4	09.2003-	F9Q820		EPBBPN3-V007Z	97073	20	300
1.9 dCi	1.870	88	4	09.2003-12.2006	F9Q820		EPBBPN3-V007Z	97073	20	300
1.9 dCi	1.870	88	4	11.2002-	F9Q680	; Position: Intake Manifold	EPBMBN3-V001Z	92099	20	256
2.0 dCi	1.995	96	4	01.2006-	M9R740, M9R750, M9R760, M9R761, M9R762, M9R763		EPBBPN3-V016Z	92713	50	350
2.0	1.998	100	4	11.2002-	F4R792		EPBMPN3-V001Z	90037	20	100
2.0 dCi	1.995	110	4	01.2006-	M9R740, M9R750, M9R814, M9R815, M9R858		EPBMPN3-V001Z	90037	20	100
2.0 dCi	1.995	110	4	01.2006-	M9R740, M9R750, M9R814, M9R815, M9R858		EPBBPN3-V016Z	92713	50	350
2.0 Turbo	1.998	120	4	-08.2003	F4R794, F4R795, F4R796, F4R797		EPBMPN3-V013Z	94788	15	255
2.0 Turbo	1.998	120	4	11.2002-	F4R794, F4R795		EPBBPN3-V019Z	95201	20	250
2.0	1.998	125	4	04.2005-	F4R896		EPBMPN3-V013Z	94788	15	255
2.0	1.998	125	4	04.2005-	F4R797, F4R897, F4R796, F4R896		EPBBPN3-V019Z	95201	20	250
2.0 dCi	1.995	127	4	01.2006-	M9R760, M9R761, M9R762, M9R763, M9R812, M9R815, M9R859		EPBMPN3-V001Z	90037	20	100
2.2 dCi	2.188	102	4	02.2006-	G9T645		EPBMBN3-V001Z	92099	20	256
2.2 dCi	2.188	102	4	02.2006-	G9T645		EPBBPN3-V007Z	97073	20	300
2.2 dCi	2.188	110	4	09.2003-12.2006	G9T742, G9T743		EPBBPN3-V007Z	97073	20	300
2.2 dCi	2.188	110	4	11.2002-	G9T742		EPBMBN3-V001Z	92099	20	256
3.5 V6	3.498	177	6	11.2002-	V4Y711, V4Y715		EPBMPN3-V001Z	90037	20	100

ESPACE V (JR_)

1.6 TCe 200	1.618	147	4	02.2015-	M5M450		EPBMPN3-A047Z	90252		
-------------	-------	-----	---	----------	--------	--	---------------	-------	--	--



FLUENCE (L3_)

1.5 dCi	1.461	63	4	02.2010-	K9K830		EPBBPN3-V007Z	97073	20	300
1.5 dCi	1.461	66	4	02.2010-	K9K834		EPBBPN3-V007Z	97073	20	300
1.5 dCi	1.461	78	4	02.2010-	K9K832		EPBBPN3-V007Z	97073	20	300
1.5 dCi	1.461	81	4	02.2010-	K9K656, K9K657, K9K836, K9K837		EPBBPN3-V007Z	97073	20	300























RENAULT

FLUENCE (L3_)

1.6 16V	1.598	81	4	02.2010-	K4M838, K4M839		EPBMPN3-V001Z	90037	20	100
1.6 16V	1.598	82	4	02.2010-	K4M838		EPBMPN3-V001Z	90037	20	100
2.0 16V	1.997	103	4	02.2010-	M4R714, M4R751		EPBMPN3-V001Z	90037	20	100

KANGOO (FC0/1_, KC0/1_)

1.2	1.149	43	4	08.1997-	D7F710, D7F720, D7F722, D7F726, D7F744, D7F746		EPBMPN3-A003Z	92477	15	102
1.2	1.149	43	4	08.1997-	D7F710, D7F720, D7F722, D7F726, D7F744, D7F746		EPBMPN3-V001Z	90037	20	100
1.2 BiFuel	1.149	43	4	07.1998-07.2001	D7F744		EPBMPN3-V005Z	93871	20	100
1.2	1.149	43	4	11.1999-04.2002	D7F720, D7F726		EPBMPN3-V005Z	93871	20	100
1.2	1.149	44	4	07.1998-07.2001	D7F710, D7F722, D7F744, D7F766, D7F764		EPBMPN3-V005Z	93871	20	100
1.2 16V	1.149	55	4	06.2001-	D4F712, D4F714, D4F716, D4F730		EPBMPN3-A003Z	92477	15	102
1.2 16V	1.149	55	4	06.2001-	D4F712, D4F714, D4F716, D4F730		EPBMPN3-V001Z	90037	20	100
1.4	1.390	55	4	08.1997-	E7J634, E7J635, E7J780, K7J700, K7J701		EPBMPN3-A003Z	92477	15	102
1.4	1.390	55	4	08.1997-	E7J634, E7J635, E7J780, K7J700, K7J701		EPBMPN3-V001Z	90037	20	100
1.5 dCi	1.461	42	4	-12.2007	K9K704		EPBBPN3-V014Z	96895	20	250
1.5 dCi	1.461	42	4	12.2002-	K9K704		EPBBPN3-V008Z	90842	20	250
1.5 dCi	1.461	45	4	-12.2007	K9K700, K9K702, K9K716		EPBBPN3-V014Z	96895	20	250
1.5 dCi	1.461	45	4	10.2005-	K9K716		EPBBPN3-V008Z	90842	20	250
1.5 dCi	1.461	48	4	11.2002-12.2007	K9K700, K9K704		EPBBPN3-V014Z	96895	20	250
1.5 dCi	1.461	48	4	12.2001-	K9K700, K9K702, K9K704		EPBBPN3-V008Z	90842	20	250
1.5 dCi	1.461	50	4	06.2005-	K9K714		EPBBPN3-V014Z	96895	20	250
1.5 dCi	1.461	60	4	-12.2007	K9K702, K9K710		EPBBPN3-V014Z	96895	20	250
1.5 dCi	1.461	60	4	07.2002-	K9K702, K9K710		EPBBPN3-V008Z	90842	20	250
1.5 dCi	1.461	62	4	06.2005-	K9K718		EPBBPN3-V014Z	96895	20	250
1.6 16V	1.598	70	4	06.2001-	K4M706, K4M730, K4M750, K4M752, K4M753		EPBMPN3-V001Z	90037	20	100
1.6 16V 4x4	1.598	70	4	10.2001-	K4M750, K4M752, K4M753		EPBMPN3-V001Z	90037	20	100

KANGOO / GRAND KANGOO (FW0/1_, KW0/1_)

1.5 dCi 70	1.461	50	4	02.2008-	K9K800, K9K802		EPBBPN3-V007Z	97073	20	300
1.5 dCi 75	1.461	55	4	09.2010-	K9K608, K9K628, K9K802, K9K808		EPBBPN3-V007Z	97073	20	300
1.5 dCi 85	1.461	63	4	02.2008-	K9K802, K9K812		EPBBPN3-V007Z	97073	20	300
1.5 dCi 90	1.461	66	4	06.2008-	K9K608, K9K628, K9K808		EPBBPN3-V007Z	97073	20	300
1.5 dCi 105	1.461	76	4	02.2008-	K9K806		EPBBPN3-V007Z	97073	20	300
1.5 dCi	1.461	78	4	02.2008-	K9K804		EPBBPN3-V007Z	97073	20	300
1.5 dCi 110	1.461	80	4	06.2009-	K9K804, K9K816		EPBBPN3-V007Z	97073	20	300

KOLEOS I (HY_)

2.0 dCi	1.995	110	4	09.2008-	M9R855, M9R856, M9R862		EPBBPN3-V016Z	92713	50	350
---------	-------	-----	---	----------	------------------------	---	---------------	-------	----	-----

MAP

 kW
C
Y
I

Type-N°

Stock-N°

 kPa from
kPa to

RENAULT
KOLEOS I (HY_)

2.0 dCi 4x4	1.995	110	4	09.2008-	M9R832, M9R833, M9R834, M9R835, M9R836, M9R838, M9R850, M9R855, M9R856, M9R862		EPBBPN3-V016Z	92713	50	350
2.0 dCi	1.995	127	4	07.2013-	M9R865		EPBBPN3-V016Z	92713	50	350
2.0 dCi 4x4	1.995	127	4	09.2008-	M9R830		EPBBPN3-V016Z	92713	50	350
2.0 dCi 4x4	1.995	130	4	09.2008-03.2013	M9R830		EPBBPN3-V016Z	92713	50	350

LAGUNA COUPE (DT0/1)

1.5 dCi	1.461	81	4	03.2012-12.2015	K9K846		EPBBPN3-V007Z	97073	20	300
2.0 dCi	1.995	110	4	09.2008-12.2015	M9R744, M9R748, M9R754, M9R802, M9R805, M9R808, M9R814, M9R845, M9R854, M9R858		EPBBPN3-V016Z	92713	50	350
2.0 dCi	1.995	127	4	09.2008-12.2015	M9R800, M9R806, M9R809, M9R815, M9R849, M9R854, M9R857		EPBBPN3-V016Z	92713	50	350
2.0 dCi GT	1.995	131	4	09.2008-12.2015	M9R816, M9R820, M9R828		EPBBPN3-V016Z	92713	50	350
2.0 16V Turbo	1.998	125	4	09.2008-12.2015	F4R811		EPBBPN3-V019Z	95201	20	250
2.0 16V Turbo	1.998	125	4	09.2008-12.2015	F4R811, F4Rt811	; OE 7700106886	EPBMPN3-V013Z	94788	15	255
2.0 GT	1.998	150	4	09.2008-12.2015	F4R800	; Position: Intake Manifold; Position: Suction Pipe; 2↑	EPBBPN3-V019Z	95201	20	250
3.0 dCi	2.998	173	6	09.2008-12.2015	V9X891	; Position: Intake Manifold	EPBBPN3-V016Z	92713	50	350
3.0 dCi	2.998	177	6	01.2012-12.2015	V9X891		EPBBPN3-V016Z	92713	50	350

LAGUNA I (B56_, 556_, K56_)

1.6 16V	1.598	79	4	11.1997-03.2001	K4M724		EPBMPN3-V005Z	93871	20	100
1.6 16V	1.598	79	4	11.1997-03.2001	K4M720, K4M724	; OE 7700101762	EPBMPN3-V001Z	90037	20	100
1.8	1.794	66	4	11.1993-03.2001	F3P670, F3P678, F3P720, F3P724		EPBMPN3-A003Z	92477	15	102
1.8	1.783	69	4	06.1995-03.2001	F3P674, F3P678, F3P720, F3P724		EPBMPN3-A003Z	92477	15	102
1.8	1.794	70	4	06.1995-06.1998	F3P676		EPBMPN3-A003Z	92477	15	102
1.8 16V	1.783	88	4	04.1998-03.2001	F4P760, F4P770		EPBMPN3-V001Z	90037	20	100
2.0	1.998	80	4	03.1999-03.2001	F3R611		EPBMPN3-A003Z	92477	15	102
2.0	1.998	83	4	11.1993-03.2001	F3R722, F3R723		EPBMPN3-A003Z	92477	15	102
2.0	1.998	84	4	06.1995-02.2001	F3R722, F3R728, F3R768		EPBMPN3-A003Z	92477	15	102
2.0 16V	1.948	102	4	06.1995-03.2001	N7Q700, N7Q704		EPBMPN3-A003Z	92477	15	102
2.0	1.948	103	4	06.1995-02.2001	N7Q700, N7Q704		EPBMPN3-A003Z	92477	15	102
2.0 16V	1.998	103	4	09.1999-03.2001	F4R780		EPBMPN3-V001Z	90037	20	100
3.0	2.963	123	6	11.1993-03.2001	Z7X760, Z7X765		EPBMPN3-A003Z	92477	15	102
3.0 24V	2.946	140	6	-12.1998	L7X700, L7X701		EPBMPN3-A009Z	92952	20	100
3.0 24V	2.946	140	6	12.1998-	L7X700, L7X701		EPBMPN3-A007Z	96754	20	105

LAGUNA II (BG0/1_,KG0/1_)

1.6 16V	1.598	79	4	03.2001-12.2007	K4M710, K4M714		EPBMPN3-V001Z	90037	20	100
1.6 16V	1.598	82	4	02.2005-08.2007	K4M716		EPBMPN3-V001Z	90037	20	100





Type-N°

Stock-N°

kPa from
kPa to

RENAULT

LAGUNA II (BG0/1_,KG0/1_)

1.8 16V	1.783	85	4	03.2001-12.2007	F4P770, F4P771, F4P773, F4P774, F4P775		EPBMPN3-V001Z	90037	20	100
1.8 16V	1.783	88	4	03.2001-09.2007	F4P770, F4P773		EPBMPN3-V001Z	90037	20	100
1.8 16V	1.783	89	4	03.2001-05.2005	F4P770, F4P772, F4P774		EPBMPN3-V001Z	90037	20	100
1.9 dCi	1.870	66	4	08.2003-09.2007	F9Q664		EPBBPN3-V007Z	97073	20	300
1.9 dCi	1.870	68	4	01.2005-	F9Q664		EPBBPN3-V007Z	97073	20	300
1.9 dCi	1.870	68	4	03.2004-05.2005	F9Q664		EPBMBN3-V001Z	92099	20	256
1.9 dCi	1.870	74	4	-08.2003	F9Q754		EPBMBN3-V001Z	92099	20	256
1.9 dCi	1.870	74	4	08.2003-	F9Q754		EPBBPN3-V007Z	97073	20	300
1.9 dCi	1.870	74	4	10.2001-05.2005	F9Q754	; OE 7700106886	EPBMPN3-V013Z	94788	15	255
1.9 dCi	1.870	77	4	-08.2003	F9Q752		EPBMBN3-V001Z	92099	20	256
1.9 dCi	1.870	77	4	06.2001-05.2005	F9Q752	; OE 7700106886	EPBMPN3-V013Z	94788	15	255
1.9 dCi	1.870	77	4	08.2003-	F9Q752		EPBBPN3-V007Z	97073	20	300
1.9 dCi	1.870	79	4	03.2001-12.2007	F9Q754	; OE 7700106886	EPBMPN3-V013Z	94788	15	255
1.9 dCi	1.870	79	4	04.2001-08.2003	F9Q754		EPBMBN3-V001Z	92099	20	256
1.9 dCi	1.870	79	4	08.2003-	F9Q754		EPBBPN3-V007Z	97073	20	300
1.9 dCi	1.870	81	4	01.2005-09.2007	F9Q674, F9Q758		EPBBPN3-V007Z	97073	20	300
1.9 dCi	1.870	81	4	01.2005-12.2007	F9Q758		EPBBPN4-V004Z	93057	50	350
1.9 dCi	1.870	81	4	01.2005-12.2007	F9Q674		EPBMPN3-V013Z	94788	15	255
1.9 dCi	1.870	81	4	01.2005-12.2007	F9Q674		EPBMBN3-V001Z	92099	20	256
1.9 dCi	1.870	85	4	09.2005-12.2007	F9Q750, F9Q758, F9Q759		EPBBPN3-V007Z	97073	20	300
1.9 dCi	1.870	85	4	08.2005-09.2007	F9Q758, F9Q759		EPBBPN4-V004Z	93057	50	350
1.9 dCi	1.870	88	4	03.2001-09.2007	F9Q650, F9Q670, F9Q674, F9Q750	; OE 7700106886	EPBMPN3-V013Z	94788	15	255
1.9 dCi	1.870	88	4	04.2001-08.2003	F9Q750		EPBMBN3-V001Z	92099	20	256
1.9 dCi	1.870	88	4	09.2003-	F9Q750		EPBBPN3-V007Z	97073	20	300
1.9 dCi	1.870	96	4	05.2005-12.2007	F9Q758, F9Q759		EPBBPN4-V004Z	93057	50	350
2.0 16V	1.998	99	4	08.2002-12.2007	F4R712, F4R713, F4R714, F4R715		EPBMPN3-V001Z	90037	20	100
2.0 16V IDE	1.998	103	4	04.2001-09.2007	F5R700, F5R701		EPBMPN3-V001Z	90037	20	100
2.0 dCi	1.995	110	4	08.2005-08.2006	M9R740		EPBBPN3-V016Z	92713	50	350
2.0 dCi	1.995	110	4	08.2005-08.2006	M9R740		EPBMPN3-V001Z	90037	20	100
2.0 16V Turbo	1.998	120	4	01.2003-08.2005	F4R764, F4R765	; OE 7700106886	EPBMPN3-V013Z	94788	15	255
2.0 16V Turbo	1.998	120	4	01.2003-08.2005	F4R764, F4R765		EPBBPN3-V019Z	95201	20	250
2.0 16V	1.998	125	4	01.2005-09.2007	F4R784, F4R786, F4R787		EPBBPN3-V019Z	95201	20	250
2.0 dCi	1.995	127	4	01.2006-12.2007	M9R760		EPBBPN3-V016Z	92713	50	350
2.0 dCi	1.995	127	4	01.2006-12.2007	M9R760		EPBMPN3-V001Z	90037	20	100
2.0 16V	1.998	150	4	01.2005-09.2007	F4R886, F4R887		EPBBPN3-V019Z	95201	20	250
2.2 dCi	2.188	102	4	05.2005-08.2007	G9T600, G9T605, G9T706, G9T707		EPBBPN3-V007Z	97073	20	300

MAP



l kW
C
Y
I



Type-N°

Stock-N°

kPa from
kPa to

RENAULT

LAGUNA II (BG0/1_,KG0/1_)

2.2 dCi	2.188	110	4	10.2001-08.2006	G9T702		EPBMBN3-V001Z	92099	20	256
2.2 dCi	2.188	110	4	10.2001-08.2006	G9T702		EPBBPN3-V007Z	97073	20	300
3.0 V6 24V	2.946	152	6	03.2001-12.2007	L7X731		EPBMPN3-A020Z	96725	20	117

LAGUNA III (BT0/1,KT0/1)

1.5 dCi	1.461	81	4	10.2007-12.2015	K9K780, K9K782		EPBBPN3-V007Z	97073	20	300
1.6 16V	1.598	81	4	10.2007-12.2015	K4M824	; Position: Intake Manifold	EPBMPN3-V001Z	90037	20	100
2.0 dCi	1.995	96	4	10.2007-12.2015	M9R742, M9R744, M9R802, M9R814, M9R854, M9R858		EPBMPN3-V001Z	90037	20	100
2.0 16V Hi-Flex	1.997	103	4	10.2007-12.2015	M4R704, M4R726	; Position: Intake Manifold	EPBMPN3-V001Z	90037	20	100
2.0 16V	1.998	103	4	10.2007-12.2015	M4R704		EPBMPN3-V001Z	90037	20	100
2.0 dCi	1.995	110	4	10.2007-12.2015	M9R742, M9R744, M9R746, M9R748, M9R754, M9R802, M9R805, M9R808, M9R814, M9R845, M9R854, M9R858		EPBMPN3-V001Z	90037	20	100
2.0 16V Turbo	1.998	125	4	10.2007-12.2015	F4R811		EPBBPN3-V019Z	95201	20	250
2.0 16V Turbo	1.998	125	4	10.2007-12.2015	F4R811	; OE 7700106886	EPBMPN3-V013Z	94788	15	255
2.0 dCi	1.995	127	4	01.2008-12.2015	M9R800, M9R806, M9R809, M9R815, M9R854, M9R857, M9R858		EPBMPN3-V001Z	90037	20	100
2.0 dCi GT	1.995	131	4	03.2008-12.2015	M9R816, M9R820, M9R828		EPBMPN3-V001Z	90037	20	100
2.0 dCi GT	1.995	131	4	03.2008-12.2015	M9R816, M9R820, M9R828		EPBBPN3-V016Z	92713	50	350
2.0 GT	1.998	150	4	03.2008-12.2015	F4R800		EPBBPN3-V019Z	95201	20	250
3.0 dCi	2.998	173	6	09.2008-12.2015	V9X891	; Position: Intake Manifold	EPBBPN3-V016Z	92713	50	350

LATITUDE (L70_)

1.5 dCi	1.461	81	4	07.2010-	K9K782		EPBBPN3-V007Z	97073	20	300
2.0 dCi 130	1.995	96	4	12.2013-	M9R756		EPBBPN3-V016Z	92713	50	350
2.0 dCi 150	1.995	110	4	02.2011-	M9R824, M9R846	; Position: Intake Manifold; Position: Suction Pipe	EPBBPN3-V016Z	92713	50	350
2.0 dCi 175	1.995	127	4	05.2011-	M9R804, M9R817, M9R844	; Position: Intake Manifold; Position: Suction Pipe	EPBBPN3-V016Z	92713	50	350
3.0 dCi 240	2.998	177	6	02.2011-	V9X891	; Position: Intake Manifold	EPBBPN3-V016Z	92713	50	350

LOGAN I (KS_, LS_, US_)

1.4	1.390	55	4	09.2004-	K7J710		EPBMPN3-V001Z	90037	20	100
1.5 dCi	1.461	48	4	-12.2016	K9K790, K9K794		EPBBPN3-V014Z	96895	20	250
1.5 dCi	1.461	50	4	04.2007-	K9K792		EPBMPN3-V001Z	90037	20	100
1.5 dCi	1.461	50	4	04.2007-	K9K792		EPBBPN3-V014Z	96895	20	250
1.5 dCi	1.461	63	4	02.2008-06.2015	K9K796		EPBBPN3-V014Z	96895	20	250
1.6	1.598	64	4	09.2004-	K7M710		EPBMPN3-V001Z	90037	20	100
1.6	1.598	77	4	04.2007-	K4M690, K4M694, K4M696, K4M697, K4M698		EPBMPN3-V001Z	90037	20	100

MASTER I (T_)

30 2,2	2.165	67	4	08.1980-07.1998	J7T782, J7T788		EPBMPN3-A003Z	92477	15	102
--------	-------	----	---	-----------------	----------------	--	---------------	-------	----	-----



MAP



l kW
C
Y
I



Type-N°

Stock-N°

kPa from

kPa to

RENAULT

MASTER II (JD/ED/FD/HD/UD)

1.9 dCi 80	1.870	60	4	11.2001-	F9Q772, F9Q774		EPBMPT4-V029Z	90509	12,7	255,3
2.2 dCi 90	2.188	66	4	09.2000-	G9T720, G9T722, G9T750		EPBMPT4-V029Z	90509	12,7	255,3
2.5 dCi 100	2.463	73	4	10.2003-	G9U754		EPBMPN3-V001Z	90037	20	100
2.5 dCi 100	2.463	73	4	-10.2006	G9U754		EPBMPT4-V029Z	90509	12,7	255,3
2.5 dCi	2.464	74	4	08.2006-	G9U650		EPBMPN3-V001Z	90037	20	100
2.5 dCi 120	2.463	84	4	10.2001-	G9U720, G9U724, G9U750, G9U754		EPBMPN3-V001Z	90037	20	100
2.5 dCi 120	2.463	84	4	10.2003-10.2006	G9U720, G9U724, G9U750, G9U754		EPBMPT4-V029Z	90509	12,7	255,3
2.5 dCi	2.464	88	4	08.2006-	G9U650		EPBBPN3-V007Z	97073	20	300
2.5 dCi	2.464	107	4	08.2006-	G9U632		EPBBPN3-V007Z	97073	20	300

MASTER III (EV, FV, HV, JV, UV)

2.3 dCi 100 FWD	2.298	74	4	02.2010-	M9T670, M9T672, M9T676, M9T870	; Position: Intake Manifold	EPBBPN3-V016Z	92713	50	350
2.3 dCi 100 RWD	2.298	74	4	02.2010-	M9T690, M9T890		EPBBPN3-V016Z	92713	50	350
2.3 dCi 110 FWD	2.298	81	4	09.2014-	M9T870, M9T704		EPBBPN3-V016Z	92713	50	350
2.3 dCi 125 RWD	2.298	92	4	02.2010-	M9T686, M9T690, M9T692, M9T696, M9T698, M9T890, M9T896	; Position: Intake Manifold	EPBBPN3-V016Z	92713	50	350
2.3 dCi 125 FWD	2.298	92	4	02.2010-	M9T670, M9T672, M9T676, M9T680, M9T870, M9T872, M9T880	; Position: Intake Manifold	EPBBPN3-V016Z	92713	50	350
2.3 dCi 135 FWD	2.298	100	4	07.2014-	M9T702	; RPO: 0261A06678-015	EPBBPN3-V016Z	92713	50	350
2.3 dCi 145 FWD	2.298	107	4	02.2010-	M9T678, M9T680, M9T706, M9T708	; RPO: 0261A06678-015	EPBBPN3-V016Z	92713	50	350
2.3 dCi 145 RWD	2.298	107	4	02.2010-	M9T694, M9T696, M9T698, M9T710	; Position: Intake Manifold	EPBBPN3-V016Z	92713	50	350
2.3 dCi 150 FWD	2.298	110	4	10.2012-	M9T880		EPBBPN3-V016Z	92713	50	350
2.3 dCi 150 RWD	2.298	110	4	03.2013-	M9T896, M9T898		EPBBPN3-V016Z	92713	50	350
2.3 dCi 165 FWD	2.298	120	4	07.2014-	M9T702, M9T708	; RPO: 0261A06678-015	EPBBPN3-V016Z	92713	50	350
2.3 dCi 170 FWD	2.298	125	4	07.2015-	M9T706	; RPO: 0261A06678-015	EPBBPN3-V016Z	92713	50	350

MEGANE CC (EZ0/1_)

1.4 Tce	1.397	96	4	06.2010-	H4J700		EPBBPT4-V001Z	92565	11	307
1.4 Tce	1.397	96	4	06.2010-	H4J700		EPBBPN3-V007Z	97073	20	300
1.5 dCi	1.461	81	4	06.2010-	K9K837		EPBBPN3-V007Z	97073	20	300
1.9 dCi	1.870	96	4	06.2010-	F9Q870	; Position: Suction Pipe	EPBBPN3-V016Z	92713	50	350
2.0 dCi	1.995	118	4	06.2010-	M9R610	; Position: Suction Pipe; Position: Intake Manifold; 21	EPBBPN3-V016Z	92713	50	350
2.0 Tce	1.998	132	4	06.2010-	F4R870, F4R872		EPBBPN3-V007Z	97073	20	300

MEGANE I (BAO/1_, EAO/1_, LAO/1_, DAO/1_, KAO/1_, KA_)

1.4 Eco	1.390	52	4	01.1996-03.1999	E7J624		EPBMPN3-A003Z	92477	15	102
1.4 e	1.390	55	4	01.1996-08.2003	E7J764		EPBMPN3-A003Z	92477	15	102
1.4 e	1.390	55	4	01.1996-08.2003	E7J626, E7J764		EPBMPN3-V001Z	90037	20	100
1.4	1.390	55	4	09.1996-08.2003	E7J764		EPBMPN3-A003Z	92477	15	102
1.4	1.390	55	4	09.1996-08.2003	E7J626		EPBMPN3-V001Z	90037	20	100



MAP



l kW
C
Y
I



Type-N°

Stock-N°

kPa from
kPa to

RENAULT

MEGANE I (BAO/1_, EAO/1_, LAO/1_, DAO/1_, KAO/1_, KA_)

1.4 16V	1.390	70	4	03.1999-08.2003	K4J700, K4J714, K4J750		EPBMPN3-V001Z	90037	20	100
1.6 i	1.598	55	4	01.1996-03.1999	K7M720		EPBMPN3-A003Z	92477	15	102
1.6 e	1.598	66	4	01.1996-08.2003	K7M702, K7M703, K7M790		EPBMPN3-A003Z	92477	15	102
1.6 16V	1.598	79	4	03.1999-08.2003	K4M700, K4M701, K4M706, K4M708, K4M709		EPBMPN3-V001Z	90037	20	100
1.8 16V	1.783	85	4	01.2001-08.2003	F4P720, F4P722		EPBMPN3-V001Z	90037	20	100
1.9 dCi	1.870	75	4	02.2001-08.2003	F9Q732, F9Q733, F9Q738		EPBBPN3-V014Z	96895	20	250
2.0 i	1.998	80	4	03.1999-08.2003	F3R750, F3R751, F3R752, F3R791, F3R796, F3R797, F3R798		EPBMPN3-A003Z	92477	15	102
2.0 i	1.998	84	4	01.1996-08.2003	F3R750, F3R751, F3R752, F3R791, F3R796, F3R797, F3R798		EPBMPN3-A003Z	92477	15	102
2.0 16V IDE	1.998	103	4	11.1999-08.2003	F5R740		EPBMPN3-A003Z	92477	15	102
2.0 16V IDE	1.998	103	4	11.1999-08.2003	F5R740		EPBMPN3-V001Z	90037	20	100
2.0 16V	1.998	108	4	03.1996-08.2003	F7R710, F7R714		EPBMPN3-A003Z	92477	15	102











MEGANE II (BMO/1_, CMO/1_, EMO/1_, KMO/1_, KM_, LMO/1_)

1.4 16V	1.390	60	4	09.2003-02.2008	K4J732		EPBMPN3-V001Z	90037	20	100
1.4 16V	1.390	72	4	11.2002-07.2009	K4J730, K4J740		EPBMPN3-V001Z	90037	20	100
1.5 dCi	1.461	60	4	09.2002-12.2010	K9K722		EPBMPN3-V001Z	90037	20	100
1.5 dCi	1.461	60	4	09.2002-10.2009	K9K722		EPBMPT4-V029Z	90509	12,7	255,3
1.5 dCi	1.461	63	4	05.2005-10.2009	K9K724		EPBBPN3-V007Z	97073	20	300
1.5 dCi	1.461	74	4	10.2004-	K9K728, K9K729		EPBBPN3-V007Z	97073	20	300
1.5 dCi	1.461	74	4	02.2004-10.2009	K9K728, K9K729		EPBMPT4-V029Z	90509	12,7	255,3
1.5 dCi	1.461	74	4	02.2004-12.2010	K9K728, K9K729		EPBMPN3-V001Z	90037	20	100
1.5 dCi	1.461	76	4	01.2007-10.2009	K9K734		EPBMPT4-V029Z	90509	12,7	255,3
1.5 dCi	1.461	76	4	01.2007-06.2009	K9K734		EPBBPN3-V007Z	97073	20	300
1.5 dCi	1.461	76	4	10.2003-12.2010	K9K734		EPBMPN3-V001Z	90037	20	100
1.5 dCi	1.461	78	4	05.2005-10.2009	K9K732		EPBBPN3-V007Z	97073	20	300
1.5 dCi	1.461	78	4	05.2005-06.2008	K9K732		EPBMPN3-V001Z	90037	20	100
1.6	1.598	77	4	06.2005-02.2008	K4M788		EPBMPN3-V001Z	90037	20	100
1.6 16V	1.598	83	4	11.2002-07.2009	K4M760, K4M761		EPBMPN3-V001Z	90037	20	100
1.9 dCi	1.870	66	4	11.2002-12.2005	F9Q808		EPBBPN3-V007Z	97073	20	300
1.9 dCi	1.870	68	4	03.2004-02.2007	F9Q808		EPBBPN3-V007Z	97073	20	300
1.9 dCi	1.870	81	4	05.2005-	F9Q804, F9Q803, F9Q816, F9Q818		EPBBPN4-V004Z	93057	50	350
1.9 dCi	1.870	85	4	11.2002-07.2009	F9Q804, F9Q816, F9Q818		EPBBPN3-V007Z	97073	20	300
1.9 dCi	1.870	85	4	11.2002-07.2009	F9Q804, F9Q816, F9Q818		EPBBPN4-V004Z	93057	50	350
1.9 dCi	1.870	88	4	11.2002-10.2009	F9Q800		EPBBPN3-V007Z	97073	20	300
1.9 dCi	1.870	96	4	05.2005-12.2009	F9Q803, F9Q804, F9Q816, F9Q818		EPBBPN4-V004Z	93057	50	350



















RENAULT

MEGANE II (BMO/1_, CMO/1_, EMO/1_, KMO/1_, KM_, LMO/1_)

2.0	1.998	99	4	09.2003-12.2009	F4R770, F4R771		EPBMPN3-V013Z	94788	15	255
2.0 16V	1.998	99	4	11.2002-07.2009	F4R770, F4R771		EPBMPN3-V001Z	90037	20	100
2.0	1.998	102	4	12.2006-01.2011	F4R770		EPBBPN3-V019Z	95201	20	250
2.0 dCi	1.995	110	4	09.2005-07.2009	M9R700, M9R722		EPBMPN3-V001Z	90037	20	100
2.0 dCi	1.995	110	4	09.2005-07.2009	M9R700, M9R722		EPBBPN3-V016Z	92713	50	350
2.0 16V Turbo	1.998	120	4	05.2004-03.2009	F4R776	 ; 2↑	EPBBPN3-V019Z	95201	20	250
2.0 dCi	1.995	127	4	01.2007-02.2008	M9R724		EPBBPN3-V016Z	92713	50	350
2.0 dCi	1.995	127	4	01.2007-02.2008	M9R724		EPBMPN3-V001Z	90037	20	100
2.0 Renault Sport	1.998	165	4	05.2004-10.2009	F4R774, F4Rt774	 ; 2↑	EPBBPN3-V019Z	95201	20	250
2.0	1.998	169	4	08.2006-02.2008	F4R774	 ; 2↑	EPBBPN3-V019Z	95201	20	250







MEGANE III (BZO/1_, B3_, DZO/1_, EZO/1_, KZO/1)

1.4 Tce	1.397	96	4	04.2009-	H4J700		EPBBPT4-V001Z	92565	11	307
1.4 TCe	1.397	96	4	04.2009-	H4J700		EPBBPN3-V007Z	97073	20	300
1.5 dCi	1.461	63	4	11.2008-	K9K830		EPBBPN3-V007Z	97073	20	300
1.5 dCi	1.461	66	4	11.2008-	K9K834		EPBBPN3-V007Z	97073	20	300
1.5 dCi	1.461	70	4	11.2013-	K9K846		EPBBPN3-V007Z	97073	20	300
1.5 dCi	1.461	78	4	02.2009-	K9K832, K9K836, K9K846		EPBBPN3-V007Z	97073	20	300
1.5 dCi	1.461	81	4	02.2009-	K9K636, K9K836, K9K837, K9K846		EPBBPN3-V007Z	97073	20	300
1.9 dCi	1.870	96	4	11.2008-	F9Q872, F9Q870	 ; Position: Suction Pipe	EPBBPN3-V016Z	92713	50	350
2.0 dCi	1.995	110	4	04.2009-	M9R615	 ; Position: Suction Pipe; Position: Intake Manifold; 2↑	EPBBPN3-V016Z	92713	50	350
2.0 dCi	1.995	118	4	04.2009-	M9R610	 ; Position: Suction Pipe; Position: Intake Manifold; 2↑	EPBBPN3-V016Z	92713	50	350
2.0 dCi	1.995	120	4	07.2012-	M9R610		EPBBPN3-V016Z	92713	50	350
2.0 Tce	1.998	132	4	11.2008-	F4R870, F4R872		EPBBPN3-V007Z	97073	20	300
2.0 TCe	1.998	140	4	-12.2016	F4R872		EPBBPN3-V007Z	97073	20	300
2.0 TCe 220	1.998	162	4	-12.2016	F4R874		EPBBPN3-V007Z	97073	20	300
2.0 Tce	1.998	184	4	05.2009-	F4R874		EPBBPN3-V007Z	97073	20	300
2.0 R.S.	1.998	195	4	-12.2016	F4R874		EPBBPN3-V007Z	97073	20	300

MEGANE IV (B9A/M/N_, K9A/M/N_)

1.6 TCe 205	1.618	151	4	11.2015-	M5M450		EPBMPN3-A047Z	90252		
-------------	-------	-----	---	----------	--------	---	---------------	-------	--	--

MEGANE SCENIC (JAO/1_)

1.4 i	1.390	55	4	01.1997-09.1999	E7J764		EPBMPN3-A003Z	92477	15	102
1.6 i	1.598	55	4	01.1997-09.1999	K7M720		EPBMPN3-A003Z	92477	15	102
1.6 e	1.598	66	4	10.1996-10.1999	K7M702, K7M703		EPBMPN3-A003Z	92477	15	102
1.6 16V	1.598	79	4	04.1998-10.1999	K4M700, K4M701, K4M704, K4M708		EPBMPN3-V001Z	90037	20	100
2.0 i	1.998	80	4	01.1999-09.1999	F3R791, F3R796		EPBMPN3-A003Z	92477	15	102
2.0 i	1.998	84	4	01.1997-09.1999	F3R750, F3R751		EPBMPN3-A003Z	92477	15	102

MAP



l kW
C
Y
I



Type-N°

Stock-N°

kPa from

kPa to

RENAULT

MODUS / GRAND MODUS (F/JPO_)

1.2	1.149	48	4	05.2005-	D4F740		EPBMPN3-V001Z	90037	20	100
1.2	1.149	55	4	12.2004-	D4F740		EPBMPN3-V001Z	90037	20	100
1.2	1.149	58	4	12.2004-	D4F764		EPBMPN3-V001Z	90037	20	100
1.2 16V	1.149	74	4	05.2007-	D4F784		EPBBPN3-V019Z	95201	20	250
1.2 16V	1.149	74	4	05.2007-	D4F784	; Position: Intake Manifold	EPBMBN3-V001Z	92099	20	256
1.2	1.149	76	4	-07.2011	D4F786		EPBBPN3-V019Z	95201	20	250
1.2	1.149	76	4	04.2011-	D4F786	; Position: Intake Manifold	EPBMBN3-V001Z	92099	20	256
1.4	1.390	72	4	12.2004-	K4J770, K4J780		EPBMPN3-V001Z	90037	20	100
1.5 dCi	1.461	48	4	12.2004-	K9K752, K9K768		EPBBPN3-V014Z	96895	20	250
1.5 dCi	1.461	50	4	12.2004-	K9K768		EPBBPN3-V007Z	97073	20	300
1.5 dCi 75	1.461	55	4	10.2010-	K9K770		EPBBPN3-V007Z	97073	20	300
1.5 dCi	1.461	60	4	09.2004-	K9K750		EPBBPN3-V007Z	97073	20	300
1.5 dCi	1.461	63	4	12.2004-	K9K760, K9K766		EPBBPN3-V007Z	97073	20	300
1.5 dCi	1.461	76	4	05.2007-	K9K772		EPBBPN3-V007Z	97073	20	300
1.5 dCi	1.461	78	4	05.2005-	K9K764		EPBBPN3-V007Z	97073	20	300
1.6	1.598	65	4	12.2004-	K4M794		EPBMPN3-V001Z	90037	20	100
1.6	1.598	82	4	12.2004-	K4M790, K4M791, K4M800, K4M801		EPBMPN3-V001Z	90037	20	100

RAPID BOX (F40_, G40_) | EXTRA | EXPRESS

1.2	1.239	40	4	09.1991- 03.1998	C3G710, C3G712		EPBMPN3-A003Z	92477	15	102
1.4 Cat	1.397	43	4	08.1988- 03.1998	C3J700, C3J702, C3J760, C3J762		EPBMPN3-A003Z	92477	15	102
1.4	1.390	55	4	09.1991- 03.1998	E7J720, E7J724, E7J726, E7J773		EPBMPN3-A003Z	92477	15	102
1.4	1.390	58	4	01.1994- 03.1998	E7J728		EPBMPN3-A003Z	92477	15	102

SAFRANE I (B54_)

2.0 12V	1.995	97	4	04.1992- 07.1996	J7R734, J7R735		EPBMPN3-A003Z	92477	15	102
2.1 dT	2.068	65	4	11.1993- 07.1996	J8S760		EPBMPN3-A003Z	92477	15	102
2.2	2.165	79	4	04.1992- 07.1996	J7T762		EPBMPN3-A003Z	92477	15	102
2.2	2.165	101	4	04.1992- 07.1996	J7T760, J7T761		EPBMPN3-A003Z	92477	15	102
3.0 V6	2.963	123	6	12.1992- 07.1996	Z7X721, Z7X722, Z7X723, Z7X753		EPBMPN3-A003Z	92477	15	102
3.0 V6 4x4	2.963	123	6	12.1992- 07.1996	Z7X721, Z7X722, Z7X723		EPBMPN3-A003Z	92477	15	102
3.0 Biturbo 4x4	2.963	193	6	02.1993- 07.1996	Z7X726		EPBMPN3-A033Z	96422	20	200

SAFRANE II (B54_)

2.0 16V	1.948	100	4	07.1996- 12.2000	N7Q710, N7Q711		EPBMPN3-A003Z	92477	15	102
2.9 24V	2.946	140	6	03.1999- 12.2000	L7X713		EPBMPN3-A007Z	96754	20	105
3.0 V6	2.963	123	6	07.1996- 12.2000	Z7X755		EPBMPN3-A003Z	92477	15	102

SANDERO/STEPWAY I (BS_)

1.4	1.390	55	4	02.2009-	K7J710		EPBMPN3-V001Z	90037	20	100
1.6	1.598	64	4	02.2009-	K7M710		EPBMPN3-V001Z	90037	20	100



MAP



l kW
C
Y
I



Type-Nº

Stock-Nº

kPa from

kPa to

RENAULT

SCÉNIC / GRAND SCÉNIC II (JM0/1_)

1.4	1.390	72	4	06.2003-11.2008	K4J730, K4J740, K4J770		EPBMPN3-V001Z	90037	20	100
1.5 dCi	1.461	60	4	-12.2006	K9K722		EPBMPT4-V029Z	90509	12,7	255,3
1.5 dCi	1.461	60	4	06.2003-05.2006	K9K722		EPBMPN3-V001Z	90037	20	100
1.5 dCi	1.461	63	4	-12.2006	K9K724		EPBMPT4-V029Z	90509	12,7	255,3
1.5 dCi	1.461	63	4	05.2005-11.2008	K9K724		EPBBPN3-V007Z	97073	20	300
1.5 dCi	1.461	74	4	-04.2009	K9K728, K9K729		EPBMPT4-V029Z	90509	12,7	255,3
1.5 dCi	1.461	74	4	11.2003-11.2008	K9K728, K9K729		EPBMPN3-V001Z	90037	20	100
1.5 dCi	1.461	76	4	-04.2009	K9K728, K9K734		EPBMPT4-V029Z	90509	12,7	255,3
1.5 dCi	1.461	76	4	06.2006-11.2008	K9K728, K9K734		EPBBPN3-V007Z	97073	20	300
1.5 dCi	1.461	78	4	-04.2009	K9K732, K9K734		EPBBPN3-V007Z	97073	20	300
1.6 16V	1.598	82	4	10.2005-11.2008	K4M706, K4M766, K4M812, K4M813		EPBMPN3-V001Z	90037	20	100
1.6	1.598	83	4	06.2003-10.2006	K4M761, K4M782		EPBMPN3-V001Z	90037	20	100
1.9 dCi	1.870	81	4	05.2005-11.2008	F9Q804		EPBBPN4-V004Z	93057	50	350
1.9 dCi	1.870	85	4	05.2005-01.2009	F9Q803, F9Q804, F9Q812		EPBBPN3-V007Z	97073	20	300
1.9 dCi	1.870	88	4	04.2004-05.2006	F9Q812		EPBBPN4-V004Z	93057	50	350
1.9 dCi	1.870	88	4	06.2003-05.2006	F9Q812		EPBBPN3-V007Z	97073	20	300
1.9 dCi	1.870	92	4	06.2003-11.2008	F9Q804		EPBBPN4-V004Z	93057	50	350
1.9 dCi	1.870	96	4	03.2004-02.2008	F9Q816, F9Q818		EPBBPN4-V004Z	93057	50	350
1.9 dCi 130	1.870	97	4	10.2005-12.2009	F9Q804		EPBBPN4-V004Z	93057	50	350
2.0	1.998	99	4	06.2003-06.2009	F4R770, F4R771		EPBMPN3-V001Z	90037	20	100
2.0	1.998	99	4	06.2003-06.2009	F4R770, F4R771		EPBMPN3-V013Z	94788	15	255
2.0	1.998	101	4	02.2008-04.2009	F4R770		EPBBPN3-V019Z	95201	20	250
2.0	1.998	103	4	06.2003-07.2010	F4R770		EPBBPN3-V019Z	95201	20	250
2.0 dCi	1.995	110	4	09.2005-11.2008	M9R700, M9R721, M9R722		EPBMPN3-V001Z	90037	20	100
2.0 dCi	1.995	110	4	09.2005-11.2008	M9R700, M9R721, M9R722		EPBBPN3-V016Z	92713	50	350

SCÉNIC / GRAND SCÉNIC III (JZ0/1_)

1.4 16V	1.397	96	4	02.2009-	H4J700		EPBBPT4-V001Z	92565	11	307
1.4 16V	1.397	96	4	02.2009-	H4J700		EPBBPN3-V007Z	97073	20	300
1.5 dCi	1.461	63	4	04.2009-	K9K830		EPBBPN3-V007Z	97073	20	300
1.5 dCi	1.461	70	4	11.2010-	K9K846		EPBBPN3-V007Z	97073	20	300
1.5 dCi	1.461	78	4	02.2009-	K9K832		EPBBPN3-V007Z	97073	20	300
1.5 dCi	1.461	81	4	04.2009-	K9K636, K9K656, K9K657, K9K836, K9K837		EPBBPN3-V007Z	97073	20	300
1.6 16V Bifuel	1.598	81	4	02.2009-	K4M866	; Position: Intake Manifold	EPBMPN3-V001Z	90037	20	100
1.6 E85	1.598	81	4	02.2009-	K4M866	; Position: Intake Manifold	EPBMPN3-V001Z	90037	20	100
1.6 16V	1.598	81	4	02.2009-	K4M858, K4MR858	; Position: Intake Manifold	EPBMPN3-V001Z	90037	20	100
1.9 dCi	1.870	96	4	02.2009-	F9Q870, F9Q872	; Position: Suction Pipe	EPBBPN3-V016Z	92713	50	350



MAP

 kW
C
Y
I

Type-N°

Stock-N°

 kPa from
kPa to

RENAULT
SCÉNIC / GRAND SCÉNIC III (JZ0/1_)

2.0 16V	1.997	103	4	02.2009-	M4R710, M4R711, M4R713	; Position: Intake Manifold	EPBMPN3-V001Z	90037	20	100
2.0 dCi	1.995	110	4	02.2009-	M9R615		EPBBPN3-V016Z	92713	50	350
2.0 dCi	1.995	118	4	04.2009-	M9R610		EPBBPN3-V016Z	92713	50	350

SCÉNIC I (JA0/1_, FA0_)

1.4 16V	1.390	70	4	09.1999-08.2003	K4J714, K4J750		EPBMPN3-V001Z	90037	20	100
1.8 16V	1.783	85	4	01.2001-08.2003	F4P720, F4P722		EPBMPN3-V001Z	90037	20	100
1.8 4x4	1.783	85	4	07.2000-04.2001	F4P722		EPBMPN3-V001Z	90037	20	100
1.9 dCi RX4	1.870	74	4	-04.2003	F9Q732, F9Q748, F9Q796		EPBBPN3-V014Z	96895	20	250
1.9 dCi	1.870	75	4	09.1999-08.2003	F9Q732, F9Q733		EPBBPN3-V014Z	96895	20	250
1.9 dCi RX4	1.870	75	4	11.2000-08.2003	F9Q740		EPBBPN3-V014Z	96895	20	250
2.0 16V	1.998	102	4	07.2000-08.2003	F4R740, F4R741, F4R746		EPBMPN3-V001Z	90037	20	100
2.0 16V RX4	1.998	102	4	06.2000-08.2003	F4R744, F4R746		EPBMPN3-V001Z	90037	20	100
2.0 16V	1.998	103	4	09.1999-08.2003	F4R740, F4R741, F4R744, F4R747		EPBMPN3-V001Z	90037	20	100

SUPER 5 (B/C40_)

1.4	1.397	43	4	10.1984-06.1988	C1J768, C1J780		EPBMPN3-A003Z	92477	15	102
1.4 Cat	1.397	43	4	10.1985-12.1996	C3J700, C3J702, C3J760		EPBMPN3-A003Z	92477	15	102
1.4	1.397	44	4	06.1987-08.1990	C2J784		EPBMPN3-A003Z	92477	15	102
1.7	1.721	54	4	10.1986-03.1995	F3N716, F3N717		EPBMPN3-A003Z	92477	15	102
1.7	1.721	64	4	06.1987-03.1995	F2N740, F2N742		EPBMPN3-A003Z	92477	15	102
1.7 i	1.721	69	4	10.1986-08.1991	F3N702, F3N722		EPBMPN3-A003Z	92477	15	102

TALISMAN (KP_, L2M_)

1.6 TCe 150	1.618	110	4	11.2015-	M5M450		EPBMPN3-A047Z	90252		
1.6 TCe 200	1.618	147	4	11.2015-	M5M450		EPBMPN3-A047Z	90252		

THALIA I (LB_) | CLIO SYMBOL

1.4	1.390	55	4	08.2000-	K7J700	; Position: Intake Manifold	EPBMPN3-V001Z	90037	20	100
1.4 16V	1.390	72	4	08.2000-	K4J712		EPBMPN3-V001Z	90037	20	100
1.5 dCi	1.461	47	4	06.2005-	K9K740		EPBBPN3-V014Z	96895	20	250
1.5 dCi	1.461	48	4	-10.2002	K9K700		EPBBPN3-V008Z	90842	20	250
1.5 dCi	1.461	48	4	12.2002-10.2007	K9K700		EPBBPN3-V014Z	96895	20	250
1.5 dCi	1.461	50	4	-10.2007	K9K700, K9K714		EPBBPN3-V014Z	96895	20	250

TRAFIC (PXX, TXX, TXW)

2.2	2.165	70	4	05.1989-06.1994	J7T780		EPBMPN3-A003Z	92477	15	102
2.2 4x4	2.165	70	4	05.1989-06.1994	J7T780		EPBMPN3-A003Z	92477	15	102
2.2	2.165	74	4	09.1994-04.1998	J7T600		EPBMPN3-A003Z	92477	15	102
2.2 4x4	2.165	74	4	09.1994-04.1998	J7T600		EPBMPN3-A003Z	92477	15	102

TRAFIC II (EL,FL,JL)

1.9 dCi	1.870	59	4	04.2001-07.2003	F9Q762	; Position: Suction Pipe	EPBBPN3-V008Z	90842	20	250
1.9 dCi 80	1.870	60	4	03.2001-12.2006	F9Q760, F9Q762		EPBBPN3-V014Z	96895	20	250



MAP



C
Y
I



Type-N°

Stock-N°

kPa from

kPa to

RENAULT

TRAFIC II (EL,FL,JL)

1.9 dCi 80	1.870	60	4	03.2001-	F9Q760, F9Q762	; Position: Suction Pipe	EPBBPN3-V008Z	90842	20	250
1.9 dCi 100	1.870	74	4	03.2001-	F9Q760	; Position: Suction Pipe	EPBBPN3-V008Z	90842	20	250
1.9 dCi 100	1.870	74	4	03.2001-	F9Q760		EPBMPN3-V001Z	90037	20	100
1.9 dCi 100	1.870	74	4	03.2001-12.2006	F9Q760		EPBBPN3-V014Z	96895	20	250
1.9 dCi	1.870	75	4	03.2001-	F9Q760	; Position: Suction Pipe	EPBBPN3-V008Z	90842	20	250
2.0 dCi 90	1.995	66	4	08.2006-	M9R630, M9R780, M9R782, M9R786		EPBBPN3-V007Z	97073	20	300
2.0 dCi 90	1.995	66	4	08.2006-	M9R780, M9R782, M9R630		EPBBPN3-V016Z	92713	50	350
2.0 dCi 115	1.995	84	4	08.2006-	M9R692, M9R780, M9R782, M9R786	; Position: Suction Pipe	EPBBPN3-V016Z	92713	50	350
2.0 dCi 115	1.995	84	4	08.2006-	M9R692, M9R780, M9R782, M9R786		EPBBPN3-V007Z	97073	20	300
2.0 16V	1.998	86	4	08.2006-	F4R820		EPBMPN3-V001Z	90037	20	100
2.0	1.998	88	4	03.2001-	F4R720, F4R722		EPBMPN3-V001Z	90037	20	100
2.5 dCi 135	2.463	99	4	03.2001-	G9U730		EPBMBN3-V001Z	92099	20	256
2.5 dCi 115	2.464	84	4	02.2008-	G9U630		EPBBPN3-V007Z	97073	20	300
2.5 dCi 145	2.464	107	4	08.2006-	G9U630		EPBBPN3-V007Z	97073	20	300

TWINGO I (C06_, S06_)

1.2	1.239	40	4	03.1993-10.1996	C3G700, C3G702		EPBMPN3-A003Z	92477	15	102
1.2	1.239	40	4	03.1993-10.1996	C3G700, C3G702		EPBMPN3-V001Z	90037	20	100
1.2	1.149	40	4	05.1996-03.2007	D7F700, D7F701	; OE 7700706876	EPBMPN3-A003Z	92477	15	102
1.2	1.149	40	4	05.1996-03.2007	D7F700, D7F701	; OE 7700101762	EPBMPN3-V001Z	90037	20	100
1.2	1.149	43	4	05.1996-06.2007	D7F700, D7F701, D7F702, D7F703, D7F704	; OE 7700706876	EPBMPN3-A003Z	92477	15	102
1.2	1.149	43	4	05.1996-06.2007	D7F700, D7F701, D7F702, D7F703, D7F704	; OE 7700101762	EPBMPN3-V001Z	90037	20	100
1.2 16V	1.149	44	4	08.2004-06.2007	D4F708		EPBMPN3-V001Z	90037	20	100
1.2 16V	1.149	55	4	01.2001-06.2007	D4F702		EPBMPN3-V001Z	90037	20	100

TWINGO II (CNO_)

1.2	1.149	43	4	03.2007-	D7F800		EPBMPN3-V005Z	93871	20	100
1.2	1.149	43	4	03.2007-	D7F800		EPBMPN3-A003Z	92477	15	102
1.2 16V	1.149	55	4	03.2007-	D4F764, D4F770, D4F772	; Position: Intake Manifold	EPBMPN3-V001Z	90037	20	100
1.2 16V	1.149	56	4	03.2007-	D4F772		EPBMPN3-V001Z	90037	20	100
1.2 Turbo	1.149	74	4	03.2007-	D4F780		EPBMBN3-V001Z	92099	20	256
1.2 Turbo	1.149	74	4	03.2007-	D4F780, D4F782		EPBBPN3-V019Z	95201	20	250
1.2 TCe 100	1.149	75	4	02.2011-	D4F780		EPBMBN3-V001Z	92099	20	256
1.2 TCe 100	1.149	75	4	02.2011-	D4F782	; Position: Intake Manifold	EPBBPN3-V019Z	95201	20	250
1.5 dCi	1.461	47	4	03.2007-	K9K740		EPBBPN3-V014Z	96895	20	250
1.5 dCi 75	1.461	55	4	10.2010-	K9K820		EPBBPN3-V007Z	97073	20	300
1.5 dCi	1.461	62	4	04.2008-	K9K718		EPBBPN3-V014Z	96895	20	250
1.5 dCi 90	1.461	63	4	10.2010-	K9K820		EPBBPN3-V007Z	97073	20	300



MAP



l kW
C
Y
I



Type-N°

Stock-N°

kPa from
kPa to

RENAULT

TWINGO II (CNO_)

1.6 RS	1.598	98	4	05.2008-	K4M854	; Position: Intake Manifold	EPBMPN3-V001Z	90037	20	100
--------	-------	----	---	----------	--------	-----------------------------	---------------	-------	----	-----

TWINGO III (BCM_)

0.9 TCe 90	898	66	3	09.2014-	H4B401		EPBBPN3-V007Z	97073	20	300
1.0 SCe 70	999	52	3	09.2014-	H4D400	; Position: Intake Manifold	EPBMPN3-V001Z	90037	20	100

VEL SATIS (BJO_)

2.0 Turbo	1.998	108	4	04.2005-	F4R867		EPBBPN3-V019Z	95201	20	250
2.0 dCi	1.995	110	4	08.2005-	M9R760		EPBBPN3-V016Z	92713	50	350
2.0 16V Turbo	1.998	120	4	10.2003-	F4R762, F4R763		EPBBPN3-V019Z	95201	20	250
2.0 16V Turbo	1.998	120	4	-08.2003	F4R762, F4R763		EPBMPN3-V013Z	94788	15	255
2.0 16 V Turbo	1.998	125	4	04.2004-	F4R766, F4R767		EPBBPN3-V019Z	95201	20	250
2.0 dCi	1.995	127	4	01.2006-	M9R760	; 2↑	EPBBPN3-V016Z	92713	50	350
2.0 dCi	1.995	127	4	01.2006-	M9R762, M9R763		EPBBPN3-V016Z	92713	50	350
2.2 dCi	2.188	83	4	12.2004-	G9T700, G9T702		EPBBPN3-V007Z	97073	20	300
2.2 dCi	2.188	85	4	04.2004-	G9T600, G9T702		EPBBPN3-V007Z	97073	20	300
2.2 dCi	2.188	102	4	-12.2009	G9T600, G9T606, G9T607		EPBBPN3-V007Z	97073	20	300
2.2 dCi	2.188	102	4	09.2004-	G9T702		EPBMBN3-V001Z	92099	20	256
2.2 dCi	2.188	110	4	06.2002-	G9T702		EPBMBN3-V001Z	92099	20	256
2.2 dCi	2.188	110	4	09.2003-12.2009	G9T702, G9T703		EPBBPN3-V007Z	97073	20	300
3.5 V6	3.498	177	6	06.2002-	V4Y701, V4Y711, V4Y715		EPBMPN3-V001Z	90037	20	100

WIND (E4M_)

1.2	1.149	74	4	07.2010-	D4F782		EPBBPN3-V019Z	95201	20	250
1.2	1.149	74	4	07.2010-	D4F782	; Position: Intake Manifold	EPBMBN3-V001Z	92099	20	256
1.2 TCe 100	1.149	75	4	02.2011-	D4F780		EPBBPN3-V019Z	95201	20	250
1.6	1.598	98	4	07.2010-	K4M854		EPBMPN3-V001Z	90037	20	100

ROVER

200 (RF, XW)

211	1.119	44	4	01.1998-03.2000	11K2D		EPBMPT4-V009Z	96309	10	117
214 i	1.396	55	4	11.1995-03.2000	14K2F		EPBMPT4-V009Z	96309	10	117
1.4	1.396	66	4	01.1996-12.1997	14K4D		EPBMPT4-V009Z	96309	10	117
214 Si	1.396	76	4	11.1995-03.2000	14K4F		EPBMPT4-V009Z	96309	10	117
216 Si	1.588	82	4	11.1995-06.1999	16K4F		EPBMPT4-V009Z	96309	10	117
220 D/SD	1.994	63	4	11.1995-03.2000	20T2R	; Chass. <YD471564	EPBBPN3-A022Z	92949	20	250
220 D/SD	1.994	63	4	11.1995-03.2000	20T2R		EPBBPN3-A028Z	93277	20	200
220 SDi	1.994	77	4	11.1995-03.2000	20T2N	; Chass. <YD471564	EPBBPN3-A022Z	92949	20	250
220 SDi	1.994	77	4	11.1995-03.2000	20T2N		EPBBPN3-A028Z	93277	20	200

25 (RF)

1.1	1.120	55	4	09.1999-05.2005	11K4F		EPBMPT4-V009Z	96309	10	117
1.4 16V	1.396	62	4	10.1999-05.2005	14K4M		EPBMPT4-V009Z	96309	10	117



MAP



l kW
C
Y
I



Type-N°

Stock-N°

kPa from

kPa to

ROVER

25 (RF)

1.4 16V	1.396	76	4	10.1999-05.2005	14K4F		EPBMPT4-V009Z	96309	10	117
1.6 16V	1.588	80	4	10.1999-05.2005	16K4F		EPBMPT4-V009Z	96309	10	117
1.8 16V	1.796	85	4	10.1999-05.2005	18K4F		EPBMPT4-V009Z	96309	10	117
2.0 iDT	1.994	74	4	10.1999-05.2005	20T2N	; Chass. <YD471564	EPBBPN3-A022Z	92949	20	250
2.0 iDT	1.994	74	4	10.1999-05.2005	20T2N		EPBBPN3-A028Z	93277	20	200
2.0 iDT	1.994	83	4	01.2002-12.2004	20T2N		EPBBPN3-A028Z	93277	20	200

400 (RT)

414	1.396	55	4	03.1996-12.1999	14K2F		EPBMPT4-V009Z	96309	10	117
414 Si	1.396	76	4	05.1995-03.2000	14K4F		EPBMPT4-V009Z	96309	10	117
416 Si	1.588	82	4	05.1995-03.2000	16K4F		EPBMPT4-V009Z	96309	10	117
416 Si	1.590	83	4	06.1995-03.2000	D16Y3		EPBMPN3-R012Z	96590	10	170
420 D	1.994	63	4	11.1995-03.2000	20T2R		EPBBPN3-A028Z	93277	20	200
420 Di	1.994	77	4	05.1995-03.2000	20T2N	; Chass. <YD471063	EPBBPN3-A022Z	92949	20	250
420 Di	1.994	77	4	05.1995-03.2000	20T2N		EPBBPN3-A028Z	93277	20	200

45 (RT)

1.4	1.396	76	4	02.2000-05.2005	14K4F		EPBMPT4-V009Z	96309	10	117
1.6	1.588	80	4	02.2000-05.2005	16K4F		EPBMPT4-V009Z	96309	10	117
1.8	1.796	86	4	02.2000-05.2005	18K4F		EPBMPT4-V009Z	96309	10	117
2.0 iDT	1.994	74	4	02.2000-05.2005	20T2N	; Chass. <YD471063	EPBBPN3-A022Z	92949	20	250
2.0 iDT	1.994	74	4	02.2000-05.2005	20T2N		EPBBPN3-A028Z	93277	20	200
2.0 iDT	1.994	83	4	01.2004-05.2005	20T2N		EPBBPN3-A028Z	93277	20	200
2.0 V6	1.997	110	6	02.2000-05.2005	20K4F		EPBMPT4-V009Z	96309	10	117

600 (RH)

620 Sdi	1.994	77	4	05.1994-06.1999	20T2N		EPBBPN3-A022Z	92949	20	250
---------	-------	----	---	-----------------	-------	--	---------------	-------	----	-----

75 (RJ)

1.8	1.796	88	4	02.1999-05.2005	K1.8		EPBMPT4-V009Z	96309	10	117
2.0 CDT	1.950	85	4	08.2001-05.2005	M47R		EPBBPN3-A005Z	90934	30	240
2.0 CDTi	1.951	96	4	02.2003-05.2005	204D2		EPBBPN3-A005Z	90934	30	240
2.0 V6	1.997	110	6	02.1999-05.2005	20K4F		EPBMPT4-V009Z	96309	10	117
2.5 V6	2.497	129	6	02.1999-10.2001	KV6		EPBMPT4-V009Z	96309	10	117
2.5 V6	2.497	130	6	10.2001-05.2005	25K4F		EPBMPT4-V009Z	96309	10	117

COMMERCE (RF)

1.4	1.396	62	4	01.2003-12.2005	14K4M		EPBMPT4-V009Z	96309	10	117
-----	-------	----	---	-----------------	-------	--	---------------	-------	----	-----

COUPE

1.6 16V	1.588	82	4	03.1996-11.1999	16K4F		EPBMPT4-V009Z	96309	10	117
1.8 16V	1.795	107	4	03.1996-11.1999	18K4K		EPBMPT4-V009Z	96309	10	117

STREETWISE

1.4	1.396	62	4	08.2003-05.2005	14K4M		EPBMPT4-V009Z	96309	10	117
-----	-------	----	---	-----------------	-------	--	---------------	-------	----	-----



MAP



l kW
C
Y
I



Type-N°

Stock-N°

kPa from
kPa to

ROVER

STREETWISE

1.4	1.396	76	4	08.2003-05.2005	14K4F		EPBMPT4-V009Z	96309	10	117
1.6	1.588	80	4	01.2004-05.2005	16K4F		EPBMPT4-V009Z	96309	10	117
1.8	1.796	86	4	08.2003-05.2005	18K4F	; Chass. >471565	EPBMPT4-V009Z	96309	10	117

SAAB

9000

2.0 -16	1.985	92	4	12.1985-12.1988	B202XI		EPBBPN3-A033Z	96394	20	200
2.0 -16	1.985	94	4	01.1989-12.1998	B202I		EPBBPN3-A033Z	96394	20	200
2.0 -16	1.985	94	4	12.1985-08.1988	B202XI		EPBBPN3-A033Z	96394	20	200
2.0 -16	1.985	96	4	09.1993-12.1998	B204I		EPBBPN3-A025Z	97101	20	250
2.0 -16 Turbo CD	1.985	108	4	09.1992-12.1998	B204E		EPBBPN3-A025Z	97101	20	250
2.0 -16 Turbo	1.985	110	4	09.1993-12.1998	B204E, B204S		EPBBPN3-A025Z	97101	20	250
2.0 -16 Turbo	1.985	118	4	05.1988-08.1993	B202XL		EPBBPN3-A033Z	96394	20	200
2.0 -16 Turbo	1.985	120	4	05.1988-08.1993	B202XL		EPBBPN3-A033Z	96394	20	200
2.0 -16 Turbo	1.985	127	4	06.1989-12.1992	B202		EPBBPN3-A033Z	96394	20	200
2.0 -16 Turbo	1.985	129	4	09.1984-12.1991	B202L, B202XL		EPBBPN3-A033Z	96394	20	200
2.3 -16	2.290	107	4	08.1989-12.1998	B234I		EPBBPN3-A025Z	97101	20	250
2.3 -16	2.290	107	4	08.1989-12.1998	B234I		EPBBPN3-A033Z	96394	20	200
2.3 -16 E	2.290	108	4	09.1993-12.1998	B234I		EPBBPN3-A025Z	97101	20	250
2.3 -16 E Eco Power	2.290	125	4	09.1993-12.1998	B234E		EPBBPN3-A025Z	97101	20	250
2.3 -16 Turbo	2.290	143	4	09.1990-12.1998	B234L		EPBBPN3-A025Z	97101	20	250
2.3 -16 Turbo	2.290	143	4	09.1990-12.1998	B234L		EPBBPN3-A033Z	96394	20	200
2.3 -16 Turbo	2.290	147	4	07.1990-12.1998	B234L		EPBBPN3-A025Z	97101	20	250
2.3 -16 Turbo	2.290	147	4	07.1990-12.1998	B234L		EPBBPN3-A033Z	96394	20	200
2.3 -16 Aero CS	2.290	162	4	02.1993-12.1998	B234R		EPBBPN3-A025Z	97101	20	250
2.3 -16 Aero CS	2.290	165	4	02.1993-12.1998	B234R		EPBBPN3-A025Z	97101	20	250

900 II

2.0 -16 Turbo	1.985	136	4	07.1993-02.1998	B204L		EPBBPN3-A025Z	97101	20	250
---------------	-------	-----	---	-----------------	-------	--	---------------	-------	----	-----

9-3 (YS3D)

2.2 TiD	2.171	85	4	02.1998-11.2000	D223L, X 22 DTH (02.98-)		EPBBPT4-V001Z	92565	11	307
2.0 Turbo	1.985	110	4	03.1999-09.2002	B205E		EPBBPN3-A025Z	97101	20	250
2.0 Turbo	1.985	110	4	03.1999-09.2002	B205E	; With Charger Intercooler	EPBBPT4-V021Z	97219	10	250
2.0 Turbo	1.985	113	4	10.1998-09.2002	B204E		EPBBPN3-A025Z	97101	20	250
2.0 Turbo	1.985	113	4	10.1998-09.2002	B204E	; With Charger Intercooler	EPBBPT4-V021Z	97219	10	250
2.2 TiD	2.171	92	4	11.2000-09.2002	D223L	; Number of Poles: 3	EPBMPN3-A034Z	92094	20	115
2.2 TiD	2.171	92	4	11.2000-09.2002	D223L		EPBBPT4-V001Z	92565	11	307
2.0 SE Turbo	1.985	147	4	01.2001-	B204R	; With Charger Intercooler	EPBBPT4-V021Z	97219	10	250
2.3 Turbo	2.290	165	4	01.2001-	B235R	; With Charger Intercooler	EPBBPT4-V021Z	97219	10	250



MAP



l kW
C
Y
I



Type-Nº

Stock-Nº

kPa from

kPa to

SAAB

9-3 (YS3D)

2.0 Turbo	1.985	110	4	01.2001-08.2003	B205E		EPBBPN3-A025Z	97101	20	250
2.0 Turbo	1.985	110	4	01.2001-08.2003	B205E	; With Charger Intercooler	EPBBPT4-V021Z	97219	10	250
2.0 SE Turbo	1.985	147	4	02.1998-08.2003	B204R		EPBBPN3-A025Z	97101	20	250
2.0 Turbo	1.985	113	4	10.1998-08.2003	B204E		EPBBPN3-A025Z	97101	20	250
2.0 Turbo	1.985	113	4	10.1998-08.2003	B204E	; With Charger Intercooler	EPBBPT4-V021Z	97219	10	250
2.0 Turbo	1.985	136	4	02.1998-09.2002	B204L, B205E, B205L		EPBBPN3-A025Z	97101	20	250
2.0 Turbo	1.985	136	4	02.1998-09.2002	B204L, B205E, B205L	; With Charger Intercooler	EPBBPT4-V021Z	97219	10	250
2.0 Turbo	1.985	136	4	02.1998-08.2003	B204L, B205E, B205L		EPBBPN3-A025Z	97101	20	250
2.0 Turbo	1.985	136	4	02.1998-08.2003	B204L, B205E, B205L	; With Charger Intercooler	EPBBPT4-V021Z	97219	10	250
2.2 TiD	2.171	85	4	02.1998-11.2000	X 22 DTH, D223L	; Number of Poles: 3	EPBMPN3-A034Z	92094	20	115

9-3 (YS3F, D79, D75, E50, E79)

1.8 i	1.796	90	4	01.2004-02.2015	Z 18 XE		EPBMPT4-V026Z	91770	12	236
1.9 TiD	1.910	88	4	09.2004-02.2015	Z 19 DT		EPBBPT4-V001Z	92565	11	307
1.9 TiD	1.910	110	4	09.2004-02.2015	Z 19 DTH		EPBBPT4-V001Z	92565	11	307
1.8t	1.998	110	4	09.2002-02.2015	B207E		EPBMPT4-V026Z	91770	12	236
2.0 t	1.998	110	4	03.2005-02.2015	B207E		EPBMPT4-V026Z	91770	12	236
2.0 t BioPower	1.998	129	4	01.2007-02.2015	B207L		EPBMPT4-V026Z	91770	12	236
2.0 t	1.998	129	4	09.2002-02.2015	B207L		EPBMPT4-V026Z	91770	12	236
2.0 t BioPower	1.998	145	4	06.2007-02.2015	B207R		EPBMPT4-V026Z	91770	12	236
2.0 t	1.998	154	4	09.2002-02.2015	B207R		EPBMPT4-V026Z	91770	12	236
2.2 TiD	2.171	92	4	09.2002-02.2015	D223L		EPBBPT4-V001Z	92565	11	307
2.8 Turbo V6	2.792	169	6	03.2005-02.2015	B284L		EPBMPN3-V010Z	93991	10	117,5
2.8 Turbo V6	2.792	184	6	03.2005-02.2015	LP9	; NTC Sensor	EPBBPT4-V010Z	91257	20	250
2.8 Turbo V6	2.792	184	6	03.2005-02.2015	LP9		EPBMPN3-V010Z	93991	10	117,5
2.8 Turbo V6	2.792	188	6	12.2007-02.2015	B284L		EPBMPN3-V010Z	93991	10	117,5
2.8 Turbo V6	2.792	203	6	05.2008-02.2015	B284R		EPBMPN3-V010Z	93991	10	117,5
2.8 Turbo V6 XWD	2.792	206	6	05.2008-12.2011	B284R		EPBMPN3-V010Z	93991	10	117,5

9-5 (YS3E)

1.9 TiD	1.910	110	4	01.2006-12.2009	Z 19 DTH		EPBBPT4-V001Z	92565	11	307
2.0 t	1.985	110	4	01.2006-	B205E		EPBBPT4-V021Z	97219	10	250
2.0 t BioPower	1.985	110	4	01.2006-	B205E		EPBBPT4-V021Z	97219	10	250
2.0 t Biopower	1.985	132	4	01.2006-	B205E		EPBBPT4-V021Z	97219	10	250
2.2 TiD	2.171	88	4	03.2002-12.2009	D223L		EPBBPT4-V001Z	92565	11	307
2.3 Turbo	2.290	134	4	04.2008-12.2009	B235E		EPBBPT4-V021Z	97219	10	250
2.3 t	2.290	136	4	01.2006-	B235E		EPBBPT4-V021Z	97219	10	250
2.3 t BioPower	2.290	136	4	01.2007-12.2009	B235E		EPBBPT4-V021Z	97219	10	250
2.3 t BioPower	2.290	152	4	11.2006-12.2009	B235R	; 2↑	EPBBPT4-V021Z	97219	10	250



MAP

 l kW
C
Y
I

Type-N°

Stock-N°

 kPa from
kPa to

SAAB
9-5 (YS3E)

2.3 Turbo	2.290	162	4	01.2006-	B235L		EPBBPT4-V021Z	97219	10	250
2.3 Turbo	2.290	184	4	01.2006-	B235R		EPBBPT4-V021Z	97219	10	250
2.3 Turbo	2.290	188	4	04.2008- 12.2009	B235R		EPBBPT4-V021Z	97219	10	250
2.3 Turbo	2.290	191	4	01.2006-	B235R		EPBBPT4-V021Z	97219	10	250
2.3 Turbo	2.290	224	4	06.2003- 08.2005	B235R	; With Charger Intercooler	EPBBPT4-V021Z	97219	10	250
3.0 V6t	2.962	147	6	01.1998- 12.2009	B308E	; Chass. >Y3040001; With Charger Intercooler	EPBBPT4-V021Z	97219	10	250

9-7X

4.2 AWD	4.157	213	6	12.2005- 07.2012	LL8		EPBMPN3-V005Z	93871	20	100
5.3 AWD	5.328	220	8	06.2004- 07.2012	LH6		EPBMPN3-V005Z	93871	20	100

SEAT
ALHAMBRA I (7V8, 7V9)

1.8 T 20V	1.781	110	4	10.1997- 03.2010	AWC	; Chass. >7M-2-510001	EPBBPT4-V003Z	91742	20	254
1.9 TDI	1.896	66	4	04.1996- 03.2010	ANU	; Chass. <7M-2-505000	EPBMBT4-D001Z	91628	11	254
1.9 TDI	1.896	66	4	04.1996- 03.2010	ANU	; Chass. >7M-2-505001	EPBBPT4-V003Z	91742	20	254
1.9 TDI	1.896	85	4	06.2000- 03.2010	AUY	; Chass. <7M-2-505000	EPBMBT4-D001Z	91628	11	254
1.9 TDI	1.896	85	4	06.2000- 03.2010	AUY	; Chass. >7M-2-505001	EPBBPT4-V003Z	91742	20	254
1.9 TDI 4motion	1.896	85	4	06.2000- 03.2010	AUY	; Chass. <7M-2-505000	EPBMBT4-D001Z	91628	11	254
1.9 TDI 4motion	1.896	85	4	06.2000- 03.2010	AUY, BVK	; Chass. >7M-2-505001	EPBBPT4-V003Z	91742	20	254
1.9 TDI	1.896	96	4	11.2002- 11.2008	ASZ		EPBBPT4-V002Z	95912	20	300
1.9 TDI	1.896	110	4	05.2005- 05.2007	BTB		EPBBPT4-V002Z	95912	20	300
2.0 TDI	1.968	103	4	11.2005- 03.2010	BRT		EPBBPT4-V002Z	95912	20	300

ALHAMBRA II (710, 711)

1.4 TSI	1.390	110	4	06.2010-	CAVA, CNWB, CTHA		EPBBPT4-V002Z	95912	20	300
1.4 TSI	1.395	110	4	05.2015-	CZDA		EPBBPT4-V002Z	95912	20	300
2.0 TDI	1.968	85	4	05.2011-	CFFE, CUVA, DFLD		EPBBPT4-V002Z	95912	20	300
2.0 TDI	1.968	100	4	06.2010- 05.2011	CFFA		EPBBPT4-V002Z	95912	20	300
2.0 TDI 4Drive	1.968	103	4	05.2011-	CFFB		EPBBPT4-V002Z	95912	20	300
2.0 TDI	1.968	103	4	06.2010-	CFFB		EPBBPT4-V002Z	95912	20	300
2.0 TDI	1.968	125	4	06.2010-	CFGB		EPBBPT4-V002Z	95912	20	300
2.0 TDI	1.968	130	4	11.2012-	CFGC, DLUB		EPBBPT4-V002Z	95912	20	300
2.0 TSI	1.984	162	4	05.2015-	DEDA		EPBBPT4-V002Z	95912	20	300

ALTEA / ALTEA XL (5P1, 5P5, 5P8)

1.4 16V	1.390	63	4	05.2006-	BXW		EPBMPT4-V008Z	96201	10	117
1.4 TSI	1.390	92	4	11.2007-	CAXC		EPBBPT4-V003Z	91742	20	254
1.6	1.595	75	4	03.2004-	BGU, BSE, BSF, CMXA	; NTC Sensor	EPBMPT4-D005Z	93653	17	117
1.6 LPG	1.595	75	4	09.2009-	CHGA		EPBMPT4-D005Z	93653	17	117
1.6 TDI	1.598	66	4	11.2010-	CAYB		EPBBPT4-V002Z	95912	20	300



MAP



l kW
C
Y
I



Type-N°

Stock-N°

kPa from
kPa to

SEAT

ALTEA / ALTEA XL (5P1, 5P5, 5P8)

1.6 TDI	1.598	77	4	10.2009-	CAYC		EPBBPT4-V002Z	95912	20	300
1.9 TDI	1.896	77	4	04.2004-	BJB, BKC, BLS, BXE		EPBBPT4-V002Z	95912	20	300
1.9 TDI	1.896	77	4	04.2004-	BJB, BKC, BLS, BXE		EPBBPT4-V003Z	91742	20	254
2.0 TDI	1.968	100	4	03.2004- 05.2009	AZV		EPBBPT4-V002Z	95912	20	300
2.0 TDI	1.968	103	4	11.2005-	BMM		EPBBPT4-V002Z	95912	20	300
2.0 TDI 16V	1.968	103	4	03.2004-	BKD, CFHC		EPBBPT4-V002Z	95912	20	300
2.0 TDI 16V 4x4	1.968	103	4	10.2010-	CFHC		EPBBPT4-V002Z	95912	20	300
2.0 FSI	1.984	110	4	05.2004- 03.2009	BLR, BLY, BVY, BVZ		EPBMPT4-D005Z	93653	17	117
2.0 TDI	1.968	125	4	03.2006-	BMN, CEGA		EPBBPT4-V002Z	95912	20	300
2.0 TDI 4x4	1.968	125	4	06.2007-	BMN		EPBBPT4-V002Z	95912	20	300

ARONA (KJ7)

1.6 SRE	1.598	81	4	07.2017-	CWVA		EPBMPT4-V008Z	96201	10	117
---------	-------	----	---	----------	------	--	---------------	-------	----	-----

AROSA (6H)

1.0	999	37	4	05.1997- 06.2004	AER, ALL		EPBMPT4-D025Z	92358	17	115
1.0	999	37	4	05.1997- 06.2004	ALD, AUC, ANV		EPBMPT4-D005Z	93653	17	117
1.0	999	37	4	05.1997- 06.2004	AHT		EPBMPT4-V004Z	92899	20	115
1.4	1.390	44	4	05.1997- 06.2004	AEX, AKV, APQ		EPBMPT4-D025Z	92358	17	115
1.4	1.390	44	4	05.1997- 06.2004	AKK, ANW, AUD		EPBMPT4-D005Z	93653	17	117
1.4 TDI	1.422	55	3	01.2000- 06.2004	AMF		EPBMBT4-D001Z	91628	11	254
1.4 16V	1.390	74	4	01.2000- 06.2004	AFK, AQQ, AUB		EPBMPT4-V004Z	92899	20	115

CORDOBA I (6K1, 6K2, 6K5)

1.0 i	999	37	4	09.1996- 10.2002	AER, ALD, ANV, AUC		EPBMPT4-D025Z	92358	17	115
1.4 i	1.390	44	4	06.1994- 12.2002	ABD, AEX, AKK, AKV, ANW, APQ, AUD		EPBMPT4-D025Z	92358	17	115
1.4 16V	1.390	55	4	06.1999- 12.2002	APE, AUA		EPBMPT4-V004Z	92899	20	115
1.8 T 20V Cupra	1.781	115	4	07.2000- 10.2002	AQX		EPBMBT4-D001Z	91628	11	254
1.9 TDI	1.896	66	4	08.1996- 12.2002	1Z, AHU		EPBMPN3-A027Z	90915	20	105
1.9 TDI	1.896	81	4	03.1997- 12.2002	AFN		EPBMPN3-A027Z	90915	20	105

CORDOBA II (6L2)

1.2	1.198	47	3	10.2002- 06.2006	AZQ, BME		EPBMPT4-D005Z	93653	17	117
1.2 12V	1.198	51	3	05.2006- 11.2009	BXV		EPBMPT4-D005Z	93653	17	117
1.4 TDI	1.422	51	3	05.2005- 11.2009	BNM		EPBBPT4-V003Z	91742	20	254
1.4 TDI	1.422	55	3	10.2002- 12.2005	AMF		EPBBPT4-V003Z	91742	20	254
1.4 16V	1.390	55	4	09.2002- 12.2007	BKY		EPBMPT4-V008Z	96201	10	117
1.4 16V	1.390	55	4	09.2002- 12.2007	BBY	; NTC Sensor	EPBMPT4-V004Z	92899	20	115
1.4 TDI	1.422	59	3	06.2005- 11.2009	BMS, BNV		EPBBPT4-V003Z	91742	20	254
1.4 16V	1.390	63	4	05.2006- 11.2009	BXW		EPBMPT4-V008Z	96201	10	117
1.4 16V	1.390	74	4	10.2002- 11.2009	AUB, BBZ		EPBMPT4-V004Z	92899	20	115



MAP

 kW
C
Y
I

Type-N°

Stock-N°

 kPa from
kPa to

SEAT
CORDOBA II (6L2)

1.6	1.598	74	4	04.2003-11.2009	BAH		EPBMPT4-V004Z	92899	20	115
1.6 16V	1.598	77	4	11.2006-11.2009	BTS		EPBMPT4-V008Z	96201	10	117
1.9 TDI	1.896	74	4	09.2002-11.2009	ATD, AXR, BMT		EPBBPT4-V003Z	91742	20	254
1.9 TDI	1.896	96	4	10.2002-11.2009	ASZ, BLT		EPBBPT4-V002Z	95912	20	300
2.0	1.984	85	4	09.2002-11.2009	AZL, BBX		EPBMPT4-V008Z	96201	10	117

EXEO (3R2,3R5)

2.0 TDI	1.968	88	4	12.2008-05.2013	CAGC, CJCC		EPBBPT4-V002Z	95912	20	300
2.0 TDI	1.968	105	4	12.2008-05.2013	CAGA, CJCA		EPBBPT4-V002Z	95912	20	300
2.0 TDI	1.968	125	4	02.2009-05.2013	CAHA, CGLB		EPBBPT4-V002Z	95912	20	300

IBIZA II (6K1)

1.0 i	999	37	4	09.1996-02.2002	AER, ALD, ANV, AUC		EPBMPT4-D025Z	92358	17	115
1.4 i	1.390	44	4	09.1993-02.2002	ABD, AEX, AKK, AKV, ANW, APQ, AUD		EPBMPT4-D025Z	92358	17	115
1.4 16V	1.390	55	4	05.2000-02.2002	APE, AUA		EPBMPT4-V004Z	92899	20	115
1.8 T 20V Cupra	1.781	115	4	07.2000-02.2002	AQX, AYP		EPBMBT4-D001Z	91628	11	254
1.9 TDI	1.896	66	4	08.1996-02.2002	1Z, AHU	; Position: Air Filter Housing	EPBMPN3-A027Z	90915	20	105
1.9 TDI	1.896	81	4	02.1997-02.2002	AFN	; Position: Air Filter Housing	EPBMPN3-A027Z	90915	20	105

IBIZA III (6L1)

1.2	1.198	44	3	06.2007-05.2008	BBM		EPBMPT4-V011Z	91119	20	115
1.2	1.198	47	3	02.2002-06.2006	AZQ, BME		EPBMPT4-D005Z	93653	17	117
1.2 12V	1.198	51	3	05.2006-11.2009	BXV		EPBMPT4-D005Z	93653	17	117
1.4 TDI	1.422	51	3	05.2005-11.2009	BNM		EPBBPT4-V003Z	91742	20	254
1.4 16V	1.390	55	4	02.2002-12.2007	BBY	; NTC Sensor	EPBMPT4-V004Z	92899	20	115
1.4 16V	1.390	55	4	02.2002-12.2007	BBY, BKY	; Position: Lower	EPBMPT4-V008Z	96201	10	117
1.4 TDI	1.422	55	3	05.2002-12.2005	AMF		EPBBPT4-V003Z	91742	20	254
1.4 TDI	1.422	59	3	06.2005-11.2009	BMS, BNV		EPBBPT4-V003Z	91742	20	254
1.4 16V	1.390	63	4	05.2006-11.2009	BXW		EPBMPT4-V008Z	96201	10	117
1.4 16V	1.390	74	4	02.2002-11.2009	BBZ		EPBBPT4-V003Z	91742	20	254
1.4 16V	1.390	74	4	02.2002-11.2009	AUB, BBZ		EPBMPT4-V004Z	92899	20	115
1.6 16V	1.598	77	4	11.2006-11.2009	BTS		EPBMPT4-V008Z	96201	10	117
1.8 T FR	1.781	110	4	12.2003-05.2008	BJX, BKV		EPBBPT4-V003Z	91742	20	254
1.8 T Cupra R	1.781	132	4	01.2004-02.2008	BBU, BLZ		EPBBPT4-V003Z	91742	20	254
1.9 TDI	1.896	74	4	02.2002-11.2009	ATD, AXR, BMT		EPBBPT4-V003Z	91742	20	254
1.9 TDI	1.896	96	4	02.2002-11.2009	ASZ, BLT		EPBBPT4-V002Z	95912	20	300
1.9 TDI Cupra R	1.896	118	4	03.2004-02.2008	BPX, BUK		EPBBPT4-V002Z	95912	20	300
2.0	1.984	85	4	04.2002-11.2009	BBX		EPBMPT4-V008Z	96201	10	117
2.0	1.984	85	4	04.2003-	BBX	; NTC Sensor	EPBBPT4-V003Z	91742	20	254



MAP



l kW
C
Y
I



Type-N°

Stock-N°

kPa from

kPa to

SEAT

IBIZA IV (6J1, 6J5, 6J8, 6P1, 6P5, 6P8)

1.0	999	55	3	05.2015-06.2017	CHYB		EPBMPT4-V008Z	96201	10	117
1.0 TSI	999	70	3	05.2015-06.2017	CHZB		EPBMPT4-V040Z	95972	20	115
1.0 TSI	999	81	3	05.2015-06.2017	CHZC		EPBMPT4-V040Z	95972	20	115
1.2	1.198	44	3	-10.2010	CGPB		EPBMPT4-D005Z	93653	17	117
1.2	1.198	44	3	12.2010-	CGPB		EPBMPT4-V008Z	96201	10	117
1.2	1.198	51	3	-05.2011	BZG, CGPA, CJLB	; NTC Sensor	EPBMPT4-D005Z	93653	17	117
1.2	1.198	51	3	03.2008-05.2015	CJLB	; Position: Intake Manifold	EPBMPT4-V008Z	96201	10	117
1.2 LPG	1.198	51	3	12.2010-	BZG		EPBMPT4-V008Z	96201	10	117
1.2	1.198	51	3	07.2008-05.2015	BZG	; Position: Intake Manifold	EPBMPT4-V008Z	96201	10	117
1.2	1.198	51	3	05.2010-05.2015	CJLB	; Position: Intake Manifold	EPBMPT4-V008Z	96201	10	117
1.2	1.198	51	3	12.2010-	BZG, CGPA		EPBMPT4-V008Z	96201	10	117
1.2 TDI	1.199	55	3	04.2010-05.2015	CFWA		EPBBPT4-V002Z	95912	20	300
1.2 TSI	1.197	66	4	05.2015-06.2017	CJZC		EPBBPT4-V002Z	95912	20	300
1.2 TSI	1.197	81	4	09.2015-06.2017	CJZD		EPBBPT4-V002Z	95912	20	300
1.4 TDI	1.422	59	3	07.2008-06.2010	BMS		EPBBPT4-V003Z	91742	20	254
1.4	1.390	63	4	03.2008-05.2015	BXW, CGGB		EPBMPT4-V008Z	96201	10	117
1.4 LPG	1.390	63	4	03.2008-05.2011	BXW		EPBMPT4-V008Z	96201	10	117
1.4 TSI	1.395	103	4	10.2013-05.2015	CPTA	; After turbocharger	EPBBPT4-V002Z	95912	20	300
1.4 TSI	1.395	110	4	11.2015-06.2017	CZEA		EPBBPT4-V002Z	95912	20	300
1.4 TSI	1.390	110	4	06.2009-05.2015	CAVF, CNUB, CTHF, CTJB		EPBBPT4-V002Z	95912	20	300
1.4 TSI Cupra	1.390	132	4	06.2009-05.2015	CAVE, CTHE, CTJC		EPBBPT4-V002Z	95912	20	300
1.6 LPG	1.598	60	4	05.2011-05.2015	CNKA		EPBMPT4-V008Z	96201	10	117
1.6 TDI	1.598	66	4	05.2009-05.2015	CAYB		EPBBPT4-V002Z	95912	20	300
1.6	1.598	77	4	05.2008-05.2015	BTS		EPBMPT4-V008Z	96201	10	117
1.6 TDI	1.598	77	4	05.2009-05.2015	CAYC, CLNA		EPBBPT4-V002Z	95912	20	300
1.8 TSI Cupra	1.798	141	4	11.2015-12.2016	DAJA		EPBBPT4-V002Z	95912	20	300
1.9 TDI	1.896	66	4	06.2008-06.2010	BXJ		EPBBPT4-V003Z	91742	20	254
1.9 TDI	1.896	77	4	03.2008-06.2010	BLS		EPBBPT4-V003Z	91742	20	254
2.0	1.984	85	4	10.2008-05.2015	CEKA	; Chass. <6J-B-196000	EPBMPT4-V008Z	96201	10	117
2.0 TDI	1.968	105	4	01.2010-05.2015	CFHD		EPBBPT4-V002Z	95912	20	300

IBIZA V (KJ1)

1.0	999	48	3	07.2017-	CHYC		EPBMPT4-V008Z	96201	10	117
1.0	999	55	3	01.2017-	CHYB		EPBMPT4-V008Z	96201	10	117

INCA (6K9)

1.4 i	1.390	44	4	11.1995-06.2003	AUD		EPBMPT4-D025Z	92358	17	115
1.4 i	1.390	44	4	11.1995-06.2003	AEX, AKV, APQ, AUD		EPBMPT4-D005Z	93653	17	117
1.4 16V	1.390	55	4	04.2000-06.2003	AUA		EPBMPT4-D025Z	92358	17	115



MAP



l kW
C
Y
I



Type-N°

Stock-N°

kPa from
kPa to

SEAT

INCA (6K9)

1.4 16V	1.390	55	4	04.2000-06.2003	AUA		EPBMPT4-V004Z	92899	20	115
---------	-------	----	---	-----------------	-----	--	---------------	-------	----	-----

LEON I (1M1)

1.4 16V	1.390	55	4	11.1999-06.2006	APE, AXP, BCA		EPBMPT4-D005Z	93653	17	117
1.4 16V	1.390	55	4	11.1999-06.2006	AHW		EPBMPT4-V004Z	92899	20	115
1.6 16 V	1.598	77	4	09.2000-06.2006	AZD		EPBMPT4-D005Z	93653	17	117
1.6 16 V	1.598	77	4	09.2000-06.2006	AUS, AZD, BCB		EPBMPT4-V004Z	92899	20	115
1.8 20V	1.781	92	4	11.1999-06.2006	APG		EPBMBT4-D001Z	91628	11	254
1.8 20V T	1.781	132	4	11.1999-06.2006	AUQ	; Chass. >1M-3M112875	EPBBPT4-V003Z	91742	20	254
1.8 20V T 4	1.781	132	4	11.1999-06.2006	ARY	; Chass. >1M-3M112875	EPBBPT4-V003Z	91742	20	254
1.9 TDI	1.896	66	4	11.1999-06.2006	AGR, ALH	; Chass. >1M-3M112875	EPBBPT4-V003Z	91742	20	254
1.9 TDI	1.896	74	4	10.2005-06.2006	AXR		EPBBPT4-V003Z	91742	20	254
1.9 TDI	1.896	81	4	11.1999-06.2006	AHF, ASV	; Chass. >1M-3M112875	EPBBPT4-V003Z	91742	20	254
1.9 TDI	1.896	96	4	05.2003-06.2006	ASZ		EPBBPT4-V002Z	95912	20	300
1.9 TDI Syncro	1.896	110	4	05.2002-06.2006	ARL	; Chass. >1M-3-015 001	EPBBPT4-V002Z	95912	20	300
1.9 TDI Syncro	1.896	110	4	05.2002-06.2006	ARL	; Chass. <1M-3-015000	EPBBPT4-V015Z	94877	20	300
1.9 TDI	1.896	110	4	09.2000-06.2006	ARL		EPBBPT4-V002Z	95912	20	300
1.9 TDI	1.896	110	4	09.2000-06.2006	ARL	; Chass. <1M-3-015000	EPBBPT4-V015Z	94877	20	300

LEON II (1P1)

1.4 16V	1.390	63	4	06.2006-12.2012	BXW		EPBMPT4-V008Z	96201	10	117
1.4 TSI	1.390	92	4	11.2007-12.2012	CAXC		EPBBPT4-V003Z	91742	20	254
1.6	1.595	75	4	07.2005-12.2012	BSE, BSF	; NTC Sensor	EPBMPT4-D005Z	93653	17	117
1.6 LPG	1.595	75	4	12.2009-12.2012	CHGA		EPBMPT4-D005Z	93653	17	117
1.6 TDI	1.598	66	4	11.2010-12.2012	CAYB		EPBBPT4-V002Z	95912	20	300
1.6 TDI	1.598	77	4	02.2010-12.2012	CAYC		EPBBPT4-V002Z	95912	20	300
1.9 TDI	1.896	66	4	06.2007-12.2010	BXF		EPBBPT4-V003Z	91742	20	254
1.9 TDI	1.896	77	4	07.2005-12.2010	BKC, BLS, BXE		EPBBPT4-V003Z	91742	20	254
2.0 TDI	1.968	100	4	07.2005-05.2010	AZV		EPBBPT4-V002Z	95912	20	300
2.0 TDI 16V	1.968	103	4	07.2005-12.2012	BKD, CFHC, CLCB		EPBBPT4-V002Z	95912	20	300
2.0 TDI	1.968	103	4	10.2005-10.2010	BMM		EPBBPT4-V002Z	95912	20	300
2.0 FSI	1.984	110	4	07.2005-05.2010	BLR, BLY, BVY, BVZ		EPBMPT4-D005Z	93653	17	117
2.0 TDI	1.968	125	4	05.2006-12.2012	BMN, CEGA, CFJA		EPBBPT4-V002Z	95912	20	300
2.0 TFSI	1.984	155	4	06.2009-12.2012	CCZB		EPBMPT4-V008Z	96201	10	117
2.0 TFSI	1.984	177	4	11.2006-05.2011	CDLD		EPBBPT4-V002Z	95912	20	300
2.0 Cupra R	1.984	195	4	09.2009-12.2012	CDLA		EPBBPT4-V002Z	95912	20	300

LEON III (5F1, 5F5, 5F8)

1.0 TSI	999	85	3	05.2015-	CHZD		EPBBPT4-V002Z	95912	20	300
1.2 TSI	1.197	63	4	12.2012-08.2018	CJZB, CYVA	; After turbocharger	EPBBPT4-V002Z	95912	20	300



MAP



l kW
C
Y
I



Type-N°

Stock-N°

kPa from

kPa to

SEAT

LEON III (5F1, 5F5, 5F8)

1.2 TSI	1.197	77	4	02.2013-04.2014	CJZA	; After turbocharger	EPBBPT4-V002Z	95912	20	300
1.2 TSI	1.197	81	4	05.2014-08.2018	CYVB	; After turbocharger	EPBBPT4-V002Z	95912	20	300
1.4 TGI	1.395	81	4	02.2013-	CPWA	; After turbocharger	EPBBPT4-V002Z	95912	20	300
1.4 TSI	1.395	90	4	09.2012-	CMBA, CXSA	; After turbocharger	EPBBPT4-V002Z	95912	20	300
1.4 TSI	1.395	92	4	05.2014-08.2018	CZCA	; Position: Suction Pipe; After turbocharger	EPBBPT4-V002Z	95912	20	300
1.4 TSI	1.395	103	4	02.2013-11.2016	CHPA, CPTA	; After turbocharger	EPBBPT4-V002Z	95912	20	300
1.4 TSI	1.395	110	4	05.2014-08.2018	CZDA, CZEA	; After turbocharger	EPBBPT4-V002Z	95912	20	300
1.8 TSI	1.798	132	4	02.2013-08.2018	CJSA, CJSB	; After turbocharger	EPBBPT4-V002Z	95912	20	300
1.8 TSI 4Drive	1.798	132	4	11.2014-	CJSA, CJSB	; After turbocharger	EPBBPT4-V002Z	95912	20	300
2.0 Cupra	1.984	195	4	10.2013-11.2016	CJXE	; After turbocharger	EPBBPT4-V002Z	95912	20	300
2.0 Cupra	1.984	206	4	10.2013-11.2016	CJXA	; After turbocharger	EPBBPT4-V002Z	95912	20	300

MII (KF1, KE1)

1.0	999	44	3	10.2011-07.2019	CHYA		EPBMPT4-V008Z	96201	10	117
1.0 EcoFuel	999	50	3	10.2012-07.2019	CPGA		EPBMPT4-V008Z	96201	10	117
1.0	999	55	3	10.2011-07.2019	CHYB		EPBMPT4-V008Z	96201	10	117

TOLEDO I (1L)

1.9 TDI	1.896	66	4	08.1995-03.1999	AHU		EPBMPN3-A027Z	90915	20	105
1.9 TDI	1.896	81	4	11.1996-03.1999	AFN		EPBMPN3-A027Z	90915	20	105

TOLEDO II (1M2)

1.4 16V	1.390	55	4	01.2000-05.2002	AXP		EPBMPT4-D005Z	93653	17	117
1.4 16V	1.390	55	4	01.2000-05.2002	AHW		EPBMPT4-V004Z	92899	20	115
1.6 16V	1.598	77	4	06.2000-05.2006	AZD		EPBMPT4-D005Z	93653	17	117
1.6 16V	1.598	77	4	06.2000-05.2006	AUS, AZD, BCB		EPBMPT4-V004Z	92899	20	115
1.8 20V	1.781	92	4	10.1998-07.2004	APG		EPBMBT4-D001Z	91628	11	254
1.8 20VT	1.781	132	4	09.2000-07.2004	AUQ	; Chass. >1M-3M112875	EPBBPT4-V003Z	91742	20	254
1.9 TDI	1.896	66	4	03.1999-07.2004	AGR, ALH	; Chass. >1M-3M112875	EPBBPT4-V003Z	91742	20	254
1.9 TDI	1.896	81	4	10.1998-07.2004	AHF, ASV	; Chass. >1M-3M112875	EPBBPT4-V003Z	91742	20	254
1.9 TDI	1.896	96	4	05.2003-05.2006	ASZ		EPBBPT4-V002Z	95912	20	300
1.9 TDI	1.896	110	4	-05.2002	ARL	; Chass. <1M-3-015000	EPBBPT4-V015Z	94877	20	300
1.9 TDI	1.896	110	4	10.2000-07.2004	ARL	; Chass. >1M-3-015 001	EPBBPT4-V002Z	95912	20	300

TOLEDO III (5P2)

1.4 16V	1.390	63	4	05.2006-05.2009	BXW		EPBMPT4-V008Z	96201	10	117
1.6	1.595	75	4	10.2004-05.2009	BGU, BSE, BSF, CCSA		EPBMPT4-D005Z	93653	17	117
1.8 TFSI	1.798	118	4	01.2007-05.2009	BYT, BZB, CDAA		EPBBPN4-V014Z	93428	20	250
1.9 TDI	1.896	77	4	10.2004-05.2009	BJB, BKC, BLS, BXE		EPBBPT4-V003Z	91742	20	254
1.9 TDI	1.896	77	4	10.2004-05.2009	BKC, BJB, BLS, BXE		EPBMPT4-V008Z	96201	10	117
2.0 TDI	1.968	100	4	09.2004-05.2009	AZV		EPBBPT4-V002Z	95912	20	300



MAP



l kW
C
Y
I



Type-Nº

Stock-Nº

kPa from
kPa to

SEAT

TOLEDO III (5P2)

2.0 TDI 16V	1.968	103	4	04.2004-05.2009	BKD		EPBBPT4-V002Z	95912	20	300
2.0 TDI	1.968	103	4	11.2005-05.2009	BMM		EPBBPT4-V002Z	95912	20	300
2.0 FSI	1.984	110	4	10.2004-05.2009	BLR, BLY, BVY, BVZ		EPBMPT4-D005Z	93653	17	117
2.0 TDI	1.968	125	4	01.2006-05.2009	BMN, CEGA		EPBBPT4-V002Z	95912	20	300
2.0 TFSI	1.984	147	4	11.2005-05.2009	BWA	; With Charger Intercooler	EPBBPN4-V014Z	93428	20	250

TOLEDO IV (KG3)

1.2	1.198	55	3	07.2012-06.2015	CGPC		EPBMPT4-V008Z	96201	10	117
1.2 TSI	1.197	66	4	05.2015-05.2017	CJZC		EPBBPT4-V002Z	95912	20	300
1.2 TSI	1.197	81	4	05.2015-05.2017	CJZD		EPBBPT4-V002Z	95912	20	300
1.4 TSI	1.395	92	4	05.2015-04.2019	CZCA		EPBBPT4-V002Z	95912	20	300
1.6 TDI	1.598	66	4	06.2013-06.2015	CAYB		EPBBPT4-V002Z	95912	20	300
1.6 TDI	1.598	77	4	07.2012-06.2015	CAYC, CLNA		EPBBPT4-V002Z	95912	20	300
1.6	1.598	77	4	07.2013-06.2015	CFNA		EPBMPT4-V008Z	96201	10	117
1.6	1.598	81	4	05.2015-04.2019	CWVA		EPBMPT4-V008Z	96201	10	117

SKODA

CITIGO

1.0	999	44	3	10.2011-	CHYA		EPBMPT4-V008Z	96201	10	117
1.0 CNG	999	50	3	11.2012-	CPGA		EPBMPT4-V008Z	96201	10	117
1.0	999	55	3	10.2011-	CHYB		EPBMPT4-V008Z	96201	10	117

FABIA I (6Y2, 6Y3, 6Y5)

1.2	1.198	40	3	07.2001-12.2007	AWY, BMD		EPBMPT4-V011Z	91119	20	115
1.2	1.198	47	3	01.2003-03.2008	AZQ, BME		EPBMPT4-D005Z	93653	17	117
1.4 16V	1.390	55	4	12.1999-03.2008	AUA, BBY	; NTC Sensor	EPBMPT4-V004Z	92899	20	115
1.4 16V	1.390	55	4	09.2003-	AUA, BBY, BKY	; Chass. >6Y43893313;	EPBMPT4-V008Z	96201	10	117
1.4 16V	1.390	59	4	04.2006-12.2007	BUD		EPBMPT4-V008Z	96201	10	117
1.4 16V	1.390	74	4	12.1999-03.2008	AUB, BBZ		EPBMPT4-V004Z	92899	20	115
1.4	1.397	44	4	04.2000-03.2003	AZE, AZF	; Chass. <6Y13174000, 1X000	EPBMPT4-V004Z	92899	20	115
1.4	1.397	44	4	01.2001-	AZE, AZF	; Chass. >6Y13174001; Chass. >6Y1X011001	EPBMPT4-V011Z	91119	20	115
1.4	1.397	50	4	08.1999-05.2003	AME, AQW, ATZ	; Chass. <6Y13174000, 1X000	EPBMPT4-V004Z	92899	20	115
1.4	1.397	50	4	01.2001-	ATZ, AME, AQW	; Chass. >6Y13174001; Chass. >6Y1X011001	EPBMPT4-V011Z	91119	20	115
1.4 TDI	1.422	51	3	10.2005-03.2008	BNM		EPBBPT4-V003Z	91742	20	254
1.4 TDI	1.422	55	3	04.2003-03.2008	AMF		EPBBPT4-V003Z	91742	20	254
1.4 TDI	1.422	59	3	10.2005-03.2008	BNV		EPBBPT4-V003Z	91742	20	254
1.9 TDI	1.896	74	4	01.2000-03.2008	ATD, AXR	; Chass. >6Y4115001	EPBBPT4-V003Z	91742	20	254
1.9 TDI RS	1.896	96	4	06.2003-03.2008	ASZ, BLT		EPBBPT4-V002Z	95912	20	300
1.0	996	37	4	12.1999-08.2002	AQV, ARV	; Chass. <6Y13174000, 1X000	EPBMPT4-V004Z	92899	20	115



MAP



l kW
C
Y
I



Type-N°

Stock-N°

kPa from

kPa to

SKODA

FABIA I (6Y2, 6Y3, 6Y5)

1.0	996	37	4	01.2001-	AQV, ARV	; Chass. >6Y13174001; Chass. >6Y1X011001	EPBMPT4-V011Z	91119	20	115
-----	-----	----	---	----------	----------	--	---------------	-------	----	-----

FABIA II (542,545)

1.2	1.198	44	3	12.2006-12.2014	BBM, CHFA		EPBMPT4-V011Z	91119	20	115
1.2 12V	1.198	44	3	11.2011-12.2014	CGPB		EPBMPT4-V008Z	96201	10	117
1.2 LPG	1.198	44	3	03.2009-11.2011	CHFA		EPBMPT4-V011Z	91119	20	115
1.2	1.198	51	3	01.2007-12.2014	BZG, CEVA, CGPA, CHTA		EPBMPT4-D005Z	93653	17	117
1.2	1.198	51	3	06.2011-	BZG, CEVA, CGPA, CHTA		EPBMPT4-V008Z	96201	10	117
1.2 TDI	1.199	55	3	05.2010-12.2014	CFWA		EPBBPT4-V002Z	95912	20	300
1.4 TDI	1.422	51	3	02.2007-03.2010	BNM		EPBBPT4-V003Z	91742	20	254
1.4 TDI	1.422	59	3	01.2007-03.2010	BMS, BNV		EPBBPT4-V003Z	91742	20	254
1.4	1.390	63	4	01.2007-12.2014	BXW, CGGB		EPBMPT4-V008Z	96201	10	117
1.4 LPG	1.390	63	4	01.2007-11.2014	BXW, CGGB		EPBMPT4-V008Z	96201	10	117
1.4 TSI RS	1.390	132	4	05.2010-12.2014	CAVE, CTHE		EPBBPT4-V002Z	95912	20	300
1.6 TDI	1.598	55	4	04.2010-12.2014	CAYA		EPBBPT4-V002Z	95912	20	300
1.6 TDI	1.598	66	4	03.2010-12.2014	CAYB		EPBBPT4-V002Z	95912	20	300
1.6 TDI	1.598	77	4	03.2010-12.2014	CAYC		EPBBPT4-V002Z	95912	20	300
1.6	1.598	77	4	04.2007-12.2014	BTS, CFNA		EPBMPT4-V008Z	96201	10	117
1.6	1.598	77	4	04.2007-12.2014	CLSA	; Position: Intake Manifold	EPBMPT4-V008Z	96201	10	117
1.9 TDI	1.896	77	4	04.2007-03.2010	BLS, BSW		EPBBPT4-V003Z	91742	20	254

FABIA III (NJ3, NJ5)

1.0	999	44	3	08.2014-	CHYA		EPBMPT4-V008Z	96201	10	117
1.0	999	55	3	08.2014-	CHYB		EPBMPT4-V008Z	96201	10	117
1.2 TSI	1.197	66	4	08.2014-	CJZC		EPBBPT4-V002Z	95912	20	300
1.2 TSI	1.197	81	4	08.2014-	CJZD		EPBBPT4-V002Z	95912	20	300
1.6	1.598	81	4	01.2015-	CWVA		EPBMPT4-V008Z	96201	10	117

FELICIA (6U1, 6U5, 6UF, 6U7)

1.3	1.289	40	4	10.1994-06.2001	AMG		EPBMPT4-V022Z	90125	15	102
1.3	1.289	43	4	10.1994-06.2001	AMJ		EPBMPT4-V022Z	90125	15	102
1.3	1.289	50	4	10.1994-04.2002	136B, AMH		EPBMPT4-V022Z	90125	15	102
1.6 LX	1.598	55	4	08.1995-04.2002	AEE		EPBMPT4-V004Z	92899	20	115

OCTAVIA I (1U2, 1U5)

1.4 16V	1.390	55	4	08.2000-12.2010	AXP, BCA		EPBMPT4-D005Z	93653	17	117
1.4	1.397	44	4	04.1999-03.2001	AMD		EPBMPT4-V011Z	91119	20	115
1.6	1.598	55	4	09.1996-09.2004	AEE		EPBMPT4-V004Z	92899	20	115
1.8 T	1.781	110	4	08.1997-12.2010	AGU, ARX, ARZ, AUM	; Chass. >1U-3A	EPBBPT4-V003Z	91742	20	254
1.8 T 4x4	1.781	110	4	05.2001-05.2006	ARX	; Chass. >1U-3A	EPBBPT4-V003Z	91742	20	254
RS 1.8 T	1.781	132	4	05.2001-01.2006	AUQ	; Chass. >1U-3A	EPBBPT4-V003Z	91742	20	254



MAP



l kW
C
Y
I



Type-N°

Stock-N°

kPa from
kPa to

SKODA

OCTAVIA I (1U2, 1U5)

1.9 TDI	1.896	66	4	09.1996-03.2010	AGR, ALH	; Chass. >1U-3A	EPBBPT4-V003Z	91742	20	254
1.9 TDI 4x4	1.896	66	4	11.1999-02.2006	AGR	; Chass. >1U-3A	EPBBPT4-V003Z	91742	20	254
1.9 TDI	1.896	74	4	08.2000-12.2010	AXR	; Chass. >1U-3A	EPBBPT4-V003Z	91742	20	254
1.9 TDI 4x4	1.896	74	4	09.2000-01.2006	ATD	; Chass. >1U-3A	EPBBPT4-V003Z	91742	20	254
1.9 TDI	1.896	81	4	08.1997-01.2006	AHF, ASV	; Chass. >1U-3A	EPBBPT4-V003Z	91742	20	254
1.9 TDI	1.896	96	4	09.2002-09.2004	ASZ		EPBBPT4-V002Z	95912	20	300

OCTAVIA II (1Z3, 1Z5)

1.4	1.390	55	4	05.2004-05.2006	BCA		EPBMPT4-V008Z	96201	10	117
1.4	1.390	59	4	06.2004-06.2013	BUD, CGGA		EPBMPT4-V008Z	96201	10	117
1.4 TSI	1.390	90	4	11.2008-06.2013	CAXA	; NTC Sensor	EPBBPT4-V003Z	91742	20	254
1.6	1.595	75	4	09.2004-06.2013	CCSA		EPBMPT4-V008Z	96201	10	117
1.6	1.595	75	4	09.2004-06.2013	CMXA	; Position: Intake Manifold	EPBMPT4-V008Z	96201	10	117
1.6	1.595	75	4	06.2004-06.2013	BGU, BSE, BSF, CMXA	; NTC Sensor	EPBMPT4-D005Z	93653	17	117
1.6 LPG	1.595	75	4	08.2009-11.2012	BSE, CHGA		EPBMPT4-D005Z	93653	17	117
1.6 MultiFuel	1.595	75	4	01.2008-06.2013	CCSA, CMXA		EPBMPT4-V008Z	96201	10	117
1.6 TDI	1.598	77	4	06.2009-04.2013	CAYC		EPBBPT4-V002Z	95912	20	300
1.6 TDI 4x4	1.598	77	4	06.2009-02.2013	CAYC		EPBBPT4-V002Z	95912	20	300
1.6 FSI	1.598	85	4	02.2004-10.2008	BLF		EPBMPT4-V008Z	96201	10	117
1.9 TDI	1.896	77	4	06.2004-12.2010	BJB, BKC, BLS, BXE		EPBBPT4-V003Z	91742	20	254
1.9 TDI 4x4	1.896	77	4	11.2004-12.2010	BKC, BLS, BXE		EPBBPT4-V003Z	91742	20	254
2.0 TDI	1.968	81	4	03.2010-06.2013	CFHF, CLCA		EPBBPT4-V002Z	95912	20	300
2.0 TDI 4x4	1.968	81	4	05.2011-02.2013	CFHF		EPBBPT4-V002Z	95912	20	300
2.0 TDI	1.968	100	4	02.2004-05.2010	AZV		EPBBPT4-V002Z	95912	20	300
2.0 TDI	1.968	103	4	11.2005-05.2010	BMM		EPBBPT4-V002Z	95912	20	300
2.0 TDI 4x4	1.968	103	4	07.2006-05.2010	BMM		EPBBPT4-V002Z	95912	20	300
2.0 TDI 16V	1.968	103	4	02.2004-05.2013	BKD, CFHC, CLCB	; NTC Sensor	EPBBPT4-V002Z	95912	20	300
2.0 TDI 16V 4x4	1.968	103	4	05.2010-02.2013	BKD, CFHC, CLCB		EPBBPT4-V002Z	95912	20	300
2.0 FSI	1.984	110	4	11.2004-10.2008	BLR, BLY, BVY, BVZ		EPBMPT4-D005Z	93653	17	117
2.0 FSI 4x4	1.984	110	4	11.2004-04.2009	BLX, BLY, BVX		EPBMPT4-D005Z	93653	17	117
2.0 TDI RS	1.968	125	4	04.2006-02.2013	BMN, CEGA		EPBBPT4-V002Z	95912	20	300

OCTAVIA III (5E3, 5E5, 5E6, NL3, NR3)

1.0 TSI	999	85	3	05.2016-	CHZD, DKRA		EPBBPT4-V002Z	95912	20	300
1.2 TSI	1.197	63	4	11.2012-	CJZB, CYVA	; After turbocharger	EPBBPT4-V002Z	95912	20	300
1.2 TSI	1.197	77	4	11.2012-	CJZA	; After turbocharger	EPBBPT4-V002Z	95912	20	300
1.2 TSI	1.197	81	4	05.2015-02.2017	CYVB		EPBBPT4-V002Z	95912	20	300
1.4 TSI G-TEC	1.395	81	4	11.2013-	CPWA	; After turbocharger	EPBBPT4-V002Z	95912	20	300
1.4 TSI	1.395	103	4	11.2012-	CHPA	; After turbocharger	EPBBPT4-V002Z	95912	20	300



MAP



l kW
C
Y
I



Type-N°

Stock-N°

kPa from

kPa to

SKODA

OCTAVIA III (5E3, 5E5, 5E6, NL3, NR3)

1.4 TSI	1.395	110	4	08.2014-	CHPB, CZDA	; After turbocharger	EPBBPT4-V002Z	95912	20	300
1.6	1.598	81	4	01.2014-	CWVA		EPBMPT4-V008Z	96201	10	117
1.8 TSI	1.798	132	4	11.2012-	CJSA		EPBBPT4-V002Z	95912	20	300
1.8 TSI 4x4	1.798	132	4	09.2014-	CJSB		EPBBPT4-V002Z	95912	20	300
2.0 TSI RS	1.984	162	4	11.2012-	CHHB	; After turbocharger	EPBBPT4-V002Z	95912	20	300
2.0 TSI RS	1.984	169	4	05.2015-	CHHA		EPBBPT4-V002Z	95912	20	300

RAPID (NH1, NH3)

1.2	1.198	55	3	07.2012-	CGPC		EPBMPT4-V008Z	96201	10	117
1.2 LPG	1.198	55	3	07.2012-	CGPC		EPBMPT4-V008Z	96201	10	117
1.6	1.598	77	4	07.2012-	CFNA		EPBMPT4-V008Z	96201	10	117
1.6	1.598	81	4	05.2015-	CWVA		EPBMPT4-V008Z	96201	10	117

ROOMSTER (5J,5J7)

1.2	1.198	47	3	05.2006-01.2007	BME		EPBMPT4-D005Z	93653	17	117
1.2	1.198	51	3	01.2007-05.2015	BZG, CGPA		EPBMPT4-D005Z	93653	17	117
1.2	1.198	51	3	09.2010-	CGPA		EPBMPT4-V008Z	96201	10	117
1.2 LPG	1.198	51	3	09.2010-	CGPA		EPBMPT4-V008Z	96201	10	117
1.2 TDI	1.199	55	3	03.2010-05.2015	CFWA		EPBBPT4-V002Z	95912	20	300
1.2 TSI	1.197	63	4	05.2011-	CBZA	; Position: Intake Manifold	EPBMPT4-V008Z	96201	10	117
1.2 TSI	1.197	77	4	05.2011-	CBZB	; Position: Intake Manifold	EPBMPT4-V008Z	96201	10	117
1.4 TDI	1.422	51	3	07.2006-03.2010	BNM		EPBBPT4-V003Z	91742	20	254
1.4 TDI	1.422	59	3	09.2006-03.2010	BMS, BNV		EPBBPT4-V003Z	91742	20	254
1.4	1.390	63	4	09.2006-05.2015	BXW, CGGB		EPBMPT4-V008Z	96201	10	117
1.4 LPG	1.390	63	4	03.2010-05.2015	BXW, CGGB		EPBMPT4-V008Z	96201	10	117
1.6 TDI	1.598	66	4	03.2010-05.2015	CAYB		EPBBPT4-V002Z	95912	20	300
1.6 TDI	1.598	77	4	03.2010-05.2015	CAYC		EPBBPT4-V002Z	95912	20	300
1.6	1.598	77	4	09.2006-05.2015	BTS, CFNA		EPBMPT4-V008Z	96201	10	117
1.6 LPG	1.598	77	4	06.2006-07.2010	BTS		EPBMPT4-V008Z	96201	10	117
1.9 TDI	1.896	74	4	03.2006-05.2006	AXR		EPBBPT4-V003Z	91742	20	254
1.9 TDI	1.896	77	4	09.2006-03.2010	BLS, BSW		EPBBPT4-V003Z	91742	20	254

SUPERB I (3U4)

1.9 TDI	1.896	74	4	08.2002-10.2005	AVB	; Chass. >3U-39036246	EPBBPT4-V003Z	91742	20	254
1.9 TDI	1.896	77	4	10.2005-05.2007	BSV		EPBBPT4-V002Z	95912	20	300
1.9 TDI	1.896	77	4	10.2005-05.2007	BSV		EPBBPT4-V003Z	91742	20	254
1.9 TDI	1.896	85	4	01.2007-03.2008	BPZ		EPBBPT4-V002Z	95912	20	300
1.9 TDI	1.896	85	4	01.2007-03.2008	BKD		EPBBPT4-V003Z	91742	20	254
1.9 TDI	1.896	96	4	12.2001-03.2008	AVF, AWX		EPBBPT4-V002Z	95912	20	300
2.0 TDI	1.968	103	4	10.2005-03.2008	BSS		EPBBPT4-V002Z	95912	20	300



MAP



l kW
C
Y
I



Type-N°

Stock-N°

kPa from
kPa to

SKODA

SUPERB I (3U4)

2.5 TDI	2.496	114	6	12.2001-08.2003	AYM	; Chass. >3U-29007041	EPBMBT4-D001Z	91628	11	254
2.5 TDI	2.496	120	6	06.2003-03.2008	BDG		EPBBPT4-V003Z	91742	20	254

SUPERB II (3T4,3T5)

1.4 TSI	1.390	92	4	07.2008-05.2015	CAXC		EPBBPT4-V003Z	91742	20	254
1.6 TDI	1.598	77	4	09.2010-05.2015	CAYC		EPBBPT4-V002Z	95912	20	300
1.9 TDI	1.896	77	4	03.2008-11.2010	BLS, BXE		EPBBPT4-V003Z	91742	20	254
2.0 TDI	1.968	103	4	03.2008-05.2010	BMP		EPBBPT4-V002Z	95912	20	300
2.0 TDI 16V	1.968	103	4	01.2009-05.2015	BKD, CFFB, CLJA		EPBBPT4-V002Z	95912	20	300
2.0 TDI 16V 4x4	1.968	103	4	11.2010-05.2015	CFFB		EPBBPT4-V002Z	95912	20	300
2.0 TDI	1.968	125	4	07.2008-05.2015	CBBB, CFGB		EPBBPT4-V002Z	95912	20	300
2.0 TDI 4x4	1.968	125	4	09.2008-05.2015	CBBB, CFGB		EPBBPT4-V002Z	95912	20	300

SUPERB III (3V3, 3V5)

1.4 TSI	1.395	92	4	03.2015-	CZCA		EPBBPT4-V002Z	95912	20	300
1.4 TSI	1.395	110	4	03.2015-	CZDA, CZEA	; Position: Intake Manifold	EPBBPT4-V002Z	95912	20	300
1.4 TSI 4x4	1.395	110	4	03.2015-	CZEA		EPBBPT4-V002Z	95912	20	300
1.8 TSI	1.798	132	4	03.2015-	CJSA, CJSC		EPBBPT4-V002Z	95912	20	300
2.0 TSI	1.984	162	4	03.2015-	CHHB		EPBBPT4-V002Z	95912	20	300
2.0 TSI 4x4	1.984	206	4	03.2015-	CJXA		EPBBPT4-V002Z	95912	20	300

YETI (5L)

1.2 TSI	1.197	77	4	09.2009-05.2015	CBZB		EPBBPT4-V003Z	91742	20	254
1.2 TSI	1.197	81	4	05.2015-12.2017	CYVB		EPBBPT4-V002Z	95912	20	300
1.4 TSI	1.390	90	4	06.2010-05.2015	CAXA		EPBBPT4-V003Z	91742	20	254
1.4 TSI	1.395	92	4	05.2015-12.2017	CZCA		EPBBPT4-V002Z	95912	20	300
1.4 TSI 4x4	1.395	110	4	05.2015-12.2017	CZDA		EPBBPT4-V002Z	95912	20	300
1.6 TDI	1.598	77	4	11.2010-05.2015	CAYC		EPBBPT4-V002Z	95912	20	300
1.6	1.598	81	4	04.2014-12.2017	CWVA		EPBMPT4-V008Z	96201	10	117
2.0 TDI	1.968	81	4	11.2009-12.2017	CFHA, CLCA, CUUA, DFSA		EPBBPT4-V002Z	95912	20	300
2.0 TDI 4x4	1.968	81	4	11.2009-12.2017	CFHF, CUUA, DFSA		EPBBPT4-V002Z	95912	20	300
2.0 TDI	1.968	103	4	11.2011-12.2017	CFHC, CLCB		EPBBPT4-V002Z	95912	20	300
2.0 TDI 4x4	1.968	103	4	05.2009-12.2017	CBDB, CFHC, CLCB	; NTC Sensor	EPBBPT4-V002Z	95912	20	300
2.0 TDI 4x4	1.968	125	4	11.2009-05.2015	CEGA, CFJA	; NTC Sensor	EPBBPT4-V002Z	95912	20	300

SMART

FORFOUR (454)

1.1	1.124	47	3	02.2005-06.2006	M134.911		EPBMPT4-V010Z	96347	10	115
1.1	1.124	55	3	01.2004-06.2006	M134.910		EPBMPT4-V010Z	96347	10	115
1.3	1.332	70	4	01.2004-06.2006	M135.930		EPBMPT4-V010Z	96347	10	115
1.5	1.499	80	4	01.2004-06.2006	M135.950		EPBMPT4-V010Z	96347	10	115



MAP



l kW C Y I



Type-N°

Stock-N°

kPa from

kPa to

SMART

FORFOUR (454)

1.5	1.499	90	4	01.2004-06.2006	M135.950		EPBMPT4-V010Z	96347	10	115
-----	-------	----	---	-----------------	----------	--	---------------	-------	----	-----

FORTWO (450, 451, 453)

0.6	599	33	3	07.1998-01.2004	M160E6ALB04		EPBMBN3-V001Z	92099	20	256
0.6	599	40	3	07.1998-01.2004	M160E6ALB03		EPBMBN3-V001Z	92099	20	256
0.6	599	45	3	01.2001-01.2004	M160E6ALB05		EPBMBN3-V001Z	92099	20	256
0.6	599	52	3	06.2002-01.2004	M160.910		EPBMBN3-V001Z	92099	20	256
0.7	698	37	3	01.2003-01.2007	M160.920		EPBMBN3-V001Z	92099	20	256
0.7	698	45	3	01.2003-01.2007	M160.920		EPBMBN3-V001Z	92099	20	256
0.7	698	55	3	01.2003-01.2007	M160.920		EPBMBN3-V001Z	92099	20	256
0.8 Cdi	799	33	3	01.2007-	OM660.950		EPBBPN3-A002Z	94523	15	260
0.8 Cdi	799	40	3	08.2009-	OM660.951		EPBBPN3-A002Z	94523	15	260
0.8 Cdi	799	40	3	08.2009-	OM660.951		EPBBPN3-A011Z	91149	50	310
1.0	999	45	3	01.2007-	M132.910		EPBMPT4-V021Z	97498	15	120
1.0	999	52	3	01.2007-	M132.910		EPBMPT4-V021Z	97498	15	120
1.0 Turbo	999	62	3	01.2007-	M132.930		EPBMPT4-V027Z	93059	10	211,5
1.0 Turbo	999	62	3	01.2007-	M132.930		EPBBPN3-A002Z	94523	15	260
1.0 Brabus	999	72	3	01.2008-	M132.930		EPBMPT4-V027Z	93059	10	211,5
1.0 Brabus	999	72	3	01.2008-	M132.930		EPBBPN3-A002Z	94523	15	260
1.0 Turbo Brabus	999	75	3	07.2010-	M132.930		EPBMPT4-V027Z	93059	10	211,5
1.0 Turbo Brabus	999	75	3	07.2010-	M132.930		EPBBPN3-A002Z	94523	15	260
1.0 Brabus	999	88	3	04.2012-	M132.930		EPBMPT4-V027Z	93059	10	211,5

ROADSTER / COUPE (452)

0.7	698	45	3	04.2003-11.2005	M160.921		EPBMBN3-V001Z	92099	20	256
0.7	698	45	3	06.2003-11.2005	M160.922		EPBMBN3-V001Z	92099	20	256
0.7	698	60	3	04.2003-11.2005	M160.922		EPBMBN3-V001Z	92099	20	256
0.7	698	60	3	04.2003-11.2005	M160.921		EPBMBN3-V001Z	92099	20	256
0.7 Brabus	698	74	3	12.2003-11.2005	M160.923		EPBMBN3-V001Z	92099	20	256

SSANGYONG

TIVOLI

1.6	1.597	94	4	04.2015-	G16DF		EPBMPT4-V016Z	92071	10	110
1.6 All-wheel Drive	1.597	94	4	03.2015-	G16DF		EPBMPT4-V016Z	92071	10	110
1.6 GPL	1.597	94	4	04.2015-	G16DF		EPBMPT4-V016Z	92071	10	110
1.6 GPL All-wheel Drive	1.597	94	4	03.2015-	G16DF		EPBMPT4-V016Z	92071	10	110

XLV CLOSED OFF-ROAD VEHICLE

e-XGi 160	1.597	94	4	04.2016-	G16DF		EPBMPT4-V016Z	92071	10	110
e-XGi 160 All-wheel Drive	1.597	94	4	04.2016-	G16DF		EPBMPT4-V016Z	92071	10	110
1.6 GPL	1.597	94	4	05.2016-	G16DF		EPBMPT4-V016Z	92071	10	110



MAP



l kW
C
Y
I



Type-Nº

Stock-Nº

kPa from

kPa to

SSANGYONG

XLV CLOSED OFF-ROAD VEHICLE

1.6 GPL All-wheel Drive	1.597	94	4	05.2016-	G16DF		EPBMPT4-V016Z	92071	10	110
-------------------------	-------	----	---	----------	-------	--	---------------	-------	----	-----

SUBARU

FORESTER (SH_)

2.0 D AWD	1.998	108	4	09.2008-09.2013	EE20Z		EPBMPT4-A024Z	91744	50	349,8
-----------	-------	-----	---	-----------------	-------	--	---------------	-------	----	-------

FORESTER (SJ_)

2.0 D AWD	1.998	108	4	03.2013-	EE20Z		EPBMPT4-A024Z	91744	50	349,8
-----------	-------	-----	---	----------	-------	--	---------------	-------	----	-------

IMPREZA (GE, GV, GR, GH, G3)

2.0 D AWD	1.998	80	4	01.2011-12.2011	EE20Z		EPBMPT4-A024Z	91744	50	349,8
-----------	-------	----	---	-----------------	-------	--	---------------	-------	----	-------

2.0 D AWD	1.998	110	4	01.2009-03.2012	EE20Z		EPBMPT4-A024Z	91744	50	349,8
-----------	-------	-----	---	-----------------	-------	--	---------------	-------	----	-------

JUSTY IV

1.0	998	51	3	01.2007-	1KR-FE		EPBMPT4-A030Z	96501	10	130
-----	-----	----	---	----------	--------	--	---------------	-------	----	-----

1.0 BiFuel	998	51	3	09.2007-03.2012	1KR-FE		EPBMPT4-A030Z	96501	10	130
------------	-----	----	---	-----------------	--------	--	---------------	-------	----	-----

LEGACY IV (BL, BP)

2.0 D AWD	1.998	110	4	02.2008-12.2009	EE20Z		EPBMPT4-A024Z	91744	50	349,8
-----------	-------	-----	---	-----------------	-------	--	---------------	-------	----	-------

3.0 R AWD	3.000	180	6	07.2004-	EZ30	; Position: Intake Manifold	EPBMPN3-V025Z	94855	10	138,7
-----------	-------	-----	---	----------	------	-----------------------------	---------------	-------	----	-------

LEGACY V (BM, BR)

2.0 D AWD	1.998	108	4	01.2013-12.2014	EE20	; Position: Intake Manifold	EPBMPT4-A024Z	91744	50	349,8
-----------	-------	-----	---	-----------------	------	-----------------------------	---------------	-------	----	-------

2.0 D AWD	1.998	108	4	01.2013-12.2014	EE20Z		EPBMPT4-A024Z	91744	50	349,8
-----------	-------	-----	---	-----------------	-------	--	---------------	-------	----	-------

2.0 D AWD	1.998	110	4	09.2009-12.2014	EE20Z		EPBMPT4-A024Z	91744	50	349,8
-----------	-------	-----	---	-----------------	-------	--	---------------	-------	----	-------

LEGACY VI (BN, BS) | B4

3.6 i AWD	3.630	191	6	01.2015-	EZ36D		EPBMPN3-V025Z	94855	10	138,7
-----------	-------	-----	---	----------	-------	--	---------------	-------	----	-------

OUTBACK (BL, BP)

2.0 D AWD	1.998	110	4	09.2008-09.2009	EE20Z		EPBMPT4-A024Z	91744	50	349,8
-----------	-------	-----	---	-----------------	-------	--	---------------	-------	----	-------

3.0 AWD	3.000	180	6	07.2004-	EZ30	; Position: Intake Manifold	EPBMPN3-V025Z	94855	10	138,7
---------	-------	-----	---	----------	------	-----------------------------	---------------	-------	----	-------

OUTBACK (BR)

2.0 D AWD	1.998	110	4	09.2009-	EE20Z		EPBMPT4-A024Z	91744	50	349,8
-----------	-------	-----	---	----------	-------	--	---------------	-------	----	-------

3.6 AWD	3.630	183	6	06.2011-12.2014	EZ36D		EPBMPN3-V025Z	94855	10	138,7
---------	-------	-----	---	-----------------	-------	--	---------------	-------	----	-------

3.6 R AWD	3.630	191	6	09.2009-	EZ36D		EPBMPN3-V025Z	94855	10	138,7
-----------	-------	-----	---	----------	-------	--	---------------	-------	----	-------

OUTBACK (BS)

3.6 AWD	3.630	191	6	10.2014-	EZ36D		EPBMPN3-V025Z	94855	10	138,7
---------	-------	-----	---	----------	-------	--	---------------	-------	----	-------

TREZIA

1.3	1.329	73	4	03.2011-	1NR-FE		EPBMPN3-V025Z	94855	10	138,7
-----	-------	----	---	----------	--------	--	---------------	-------	----	-------

XV (_GP_)

2.0 D AWD	1.998	80	4	03.2012-	EE20Z		EPBMPT4-A024Z	91744	50	349,8
-----------	-------	----	---	----------	-------	--	---------------	-------	----	-------

2.0 D AWD	1.998	108	4	03.2012-	EE20Z		EPBMPT4-A024Z	91744	50	349,8
-----------	-------	-----	---	----------	-------	--	---------------	-------	----	-------

SUZUKI

ALTO (HA12, HA23)

1.0	993	43	4	01.2000-06.2002	G10BB		EPBMPN3-V031Z	92481	10	120
-----	-----	----	---	-----------------	-------	--	---------------	-------	----	-----

GRAND VITARA I (FT, GT, HT)

1.6 4x4	1.590	69	4	03.1998-07.2003	G16B		EPBMPN3-V031Z	92481	10	120
---------	-------	----	---	-----------------	------	--	---------------	-------	----	-----



MAP



kW
C
Y
I



Type-N°

Stock-N°

kPa from

kPa to

SUZUKI

GRAND VITARA I (FT, GT, HT)

1.6 4x4	1.590	73	4	02.2000-09.2002	G16B	; Position: Exhaust pipe on silencer	EPBMPN3-V031Z	92481	10	120
2.0 TD 4x4	1.998	63	4	04.2000-09.2005	RFM		EPBBPN3-A003Z	91268	10	250
2.0 HDI 110 4x4	1.997	80	4	07.2001-09.2005	RHZ		EPBBPN3-A003Z	91268	10	250
2.0 HDI 110 16V 4x4	1.997	80	4	07.2001-09.2005	RHW		EPBBPN3-A003Z	91268	10	250
2.0 4x4	1.995	94	4	03.1998-07.2003	J20A		EPBMPN3-V031Z	92481	10	120
2.0 4x4	1.995	97	4	08.1998-12.2000	J20A		EPBMPN3-V031Z	92481	10	120
2.7	2.736	127	6	06.2001-08.2003	H27A		EPBMPN3-V031Z	92481	10	120
2.7 4x4	2.736	127	6	09.2001-07.2003	H27A		EPBMPN3-V031Z	92481	10	120
2.7	2.736	135	6	09.2003-08.2006	H27A		EPBMPN3-V031Z	92481	10	120
2.7 4x4	2.736	135	6	04.2003-07.2003	H27A		EPBMPN3-V031Z	92481	10	120

GRAND VITARA II (JT, TE, TD)

1.6	1.586	78	4	10.2005-	M16A		EPBMPN3-V031Z	92481	10	120
1.6 All-wheel Drive	1.586	78	4	04.2005-	M16A		EPBMPN3-V031Z	92481	10	120
1.9 DDiS	1.870	95	4	03.2006-08.2008	F9QB	; Great Britain; Germany	EPBBPN4-V004Z	93057	50	350
1.9 DDiS	1.870	95	4	03.2006-08.2008	F9QB	; Great Britain; Germany	EPBBPN3-V016Z	92713	50	350
1.9 DDiS All-wheel Drive	1.870	95	4	10.2005-02.2015	F9QB		EPBBPN4-V004Z	93057	50	350
2.0 All-wheel Drive	1.995	103	4	10.2005-02.2015	J20A		EPBMPN3-V031Z	92481	10	120
2.4 All-wheel Drive	2.393	122	4	01.2009-	J24B		EPBMPN3-V031Z	92481	10	120
2.4 All-wheel Drive	2.393	124	4	01.2009-	J24B		EPBMPN3-V031Z	92481	10	120

IGNIS I (FH)

1.3	1.328	61	4	10.2000-09.2003	M13A		EPBMPN3-V031Z	92481	10	120
1.3 4WD	1.328	61	4	10.2000-09.2003	M13A		EPBMPN3-V031Z	92481	10	120
1.5 Sport	1.490	80	4	12.2003-12.2005	M15A		EPBMPN3-V031Z	92481	10	120

IGNIS II (MH)

1.3 DDiS	1.248	51	4	09.2003-	Z13DT		EPBMBN3-V001Z	92099	20	256
1.3	1.328	69	4	09.2003-	M13A		EPBMPN3-V031Z	92481	10	120
1.3 4x4	1.328	69	4	09.2003-	M13A		EPBMPN3-V031Z	92481	10	120
1.5	1.490	73	4	09.2003-	M15A		EPBMPN3-V031Z	92481	10	120
1.5 4x4	1.490	73	4	09.2003-	M15A		EPBMPN3-V031Z	92481	10	120

JIMNY (SN)

1.3 16V	1.328	60	4	02.2001-	M13A		EPBMPN3-V031Z	92481	10	120
1.3 16V 4WD	1.328	60	4	02.2001-	M13A		EPBMPN3-V031Z	92481	10	120
1.3	1.328	63	4	08.2004-	M13A		EPBMPN3-V031Z	92481	10	120
1.3 4WD	1.328	63	4	03.2013-	M13A		EPBMPN3-V031Z	92481	10	120
1.3 16V 4x4	1.328	63	4	08.2005-	M13A		EPBMPN3-V031Z	92481	10	120
1.5 DDiS 4x4	1.461	63	4	08.2005-	K9K266		EPBBPN3-V007Z	97073	20	300



MAP



l kW
C
Y
I



Type-N°

Stock-N°

kPa from
kPa to

SUZUKI

LIANA (ER, RH_)

1.3	1.328	66	4	07.2001-12.2007	M13A		EPBMPN3-V031Z	92481	10	120
1.4 DDiS	1.398	66	4	04.2004-12.2007	8HY		EPBBPN3-A001Z	94263	10	240
1.6	1.586	76	4	07.2001-12.2007	M16A		EPBMPN3-V031Z	92481	10	120
1.6 4WD	1.586	76	4	07.2001-12.2007	M16A		EPBMPN3-V031Z	92481	10	120
1.6 i	1.586	78	4	04.2002-12.2007	M16A		EPBMPN3-V031Z	92481	10	120
1.6 4WD	1.586	78	4	04.2002-12.2007	M16A		EPBMPN3-V031Z	92481	10	120
1.6	1.586	79	4	01.2005-12.2007	M16A		EPBMPN3-V031Z	92481	10	120
1.6 4WD	1.586	79	4	01.2005-12.2007	M16A		EPBMPN3-V031Z	92481	10	120

SPLASH (EX)

1.0	996	48	3	01.2008-	K10B		EPBMPN3-V026Z	94423	10	117,9
1.0	996	50	3	06.2011-	K10B		EPBMPN3-V026Z	94423	10	117,9
1.2	1.242	63	4	01.2008-	K12B	; Chass. <S00380001	EPBMPN3-V026Z	94423	10	117,9
1.2 LPG	1.242	63	4	04.2008-12.2014	K12B	; Chass. <S00380001	EPBMPN3-V026Z	94423	10	117,9
1.2 VVT	1.242	67	4	08.2012-	K12B	; Position: Intake Manifold	EPBMPN3-V026Z	94423	10	117,9
1.2 VVT	1.242	69	4	09.2010-	K12B	; Chass. <S00380001	EPBMPN3-V026Z	94423	10	117,9
1.3 CDTI	1.248	55	4	01.2008-	D13A	; Position: Intake Manifold	EPBMBN3-V001Z	92099	20	256

SWIFT III (MZ, EZ)

1.3 DDiS	1.248	51	4	08.2005-	Z13DT		EPBMBN3-V001Z	92099	20	256
1.3 DDiS	1.248	55	4	08.2005-	D13A		EPBMBN3-V001Z	92099	20	256
1.3 4x4	1.328	66	4	01.2006-	M13A		EPBMPN3-V031Z	92481	10	120
1.3	1.328	67	4	02.2005-06.2015	M13A		EPBMPN3-V031Z	92481	10	120
1.3	1.328	68	4	02.2005-	M13A		EPBMPN3-V031Z	92481	10	120
1.3 4x4	1.328	68	4	02.2005-	M13A		EPBMPN3-V031Z	92481	10	120
1.3 LPG	1.328	68	4	09.2008-12.2010	M13A		EPBMPN3-V031Z	92481	10	120
1.5 4x4	1.490	74	4	02.2005-	M15A	; Type: 1,2	EPBMPN3-V031Z	92481	10	120
1.5	1.490	75	4	02.2005-	M15A		EPBMPN3-V031Z	92481	10	120
1.6	1.586	92	4	05.2006-	M16A		EPBMPN3-V031Z	92481	10	120

SX4 (EY, GY, RW)

1.5	1.490	73	4	06.2006-07.2010	M15A		EPBMPN3-V031Z	92481	10	120
1.5 VVTi	1.490	81	4	07.2007-12.2015	M15A		EPBMPN3-V031Z	92481	10	120
1.5 VVT	1.490	82	4	07.2010-	M15A		EPBMPN3-V031Z	92481	10	120
1.5 VVT 4x4	1.490	82	4	07.2010-	M15A		EPBMPN3-V031Z	92481	10	120
1.6 DDiS	1.560	66	4	04.2007-	9HX		EPBBPN3-A001Z	94263	10	240
1.6 VVT	1.586	79	4	06.2006-	M16A		EPBMPN3-V031Z	92481	10	120
1.6 VVT 4x4	1.586	79	4	06.2006-	M16A		EPBMPN3-V031Z	92481	10	120
1.6	1.586	79	4	10.2007-	M16A		EPBMPN3-V031Z	92481	10	120
1.6 AWD	1.586	79	4	10.2007-12.2011	M16A		EPBMPN3-V031Z	92481	10	120



MAP



l kW
C
Y
I



Type-Nº

Stock-Nº

kPa from

kPa to

SUZUKI

SX4 (EY, GY, RW)

1.6 LPG	1.586	79	4	06.2006-12.2012	M16A		EPBMPN3-V031Z	92481	10	120
1.6 VVT	1.586	82	4	11.2010-12.2015	M16A		EPBMPN3-V031Z	92481	10	120
1.6 VVT 4x4	1.586	82	4	07.2009-	M16A		EPBMPN3-V031Z	92481	10	120
1.6	1.586	88	4	10.2007-	M16A		EPBMPN3-V031Z	92481	10	120
1.6 VVT	1.586	88	4	07.2009-	M16A		EPBMPN3-V031Z	92481	10	120
1.6 VVT 4x4	1.586	88	4	07.2009-	M16A		EPBMPN3-V031Z	92481	10	120

WAGON R

1.3 DDiS	1.248	51	4	09.2003-	Z13DT		EPBMBN3-V001Z	92099	20	256
1.3	1.298	56	4	05.2000-12.2004	G13BB, G13BB		EPBMPN3-V031Z	92481	10	120
1.3 4WD	1.298	56	4	10.2001-	G13BB		EPBMPN3-V031Z	92481	10	120
1.3	1.328	65	4	09.2003-12.2010	M13A		EPBMPN3-V031Z	92481	10	120
1.3	1.328	69	4	09.2003-	M13A		EPBMPN3-V031Z	92481	10	120
1.3 4WD	1.328	69	4	09.2003-	M13A		EPBMPN3-V031Z	92481	10	120

WAGON R+ (EM)

1.3	1.298	56	4	04.1999-10.2000	G13BB		EPBMPN3-V031Z	92481	10	120
-----	-------	----	---	-----------------	-------	--	---------------	-------	----	-----

TOYOTA

AURIS (_E15_) | COROLLA

1.33 Dual-VVTi	1.329	73	4	01.2010-09.2012	1NR-FE		EPBMPN3-V025Z	94855	10	138,7
1.33 Dual-VVTi	1.329	74	4	05.2009-09.2012	1NR-FE		EPBMPN3-V025Z	94855	10	138,7
1.4 D-4D	1.364	66	4	-12.2008	1ND-TV		EPBMBN3-V004Z	90962	10	270,3
1.4 D-4D	1.364	66	4	12.2008-	1ND-TV		EPBMBN3-V005Z	90946	27,8	400
1.6	1.598	91	4	03.2007-09.2012	1ZR-FE		EPBMPN3-V025Z	94855	10	138,7
1.6	1.598	97	4	05.2009-09.2012	1ZR-FAE		EPBMPN3-V025Z	94855	10	138,7
1.8 Hybrid	1.798	73	4	09.2010-09.2012	2ZR-FXE		EPBMPN4-A023Z	91984	11,2	307,2
1.8	1.798	100	4	10.2006-09.2012	2ZR-FAE	; Position: Intake Manifold	EPBMPN3-V025Z	94855	10	138,7
1.8 4WD	1.798	100	4	02.2009-09.2012	2ZR-FAE	; Position: Intake Manifold	EPBMPN3-V025Z	94855	10	138,7
1.8	1.798	106	4	02.2009-09.2012	2ZR-FAE	; Position: Intake Manifold	EPBMPN3-V025Z	94855	10	138,7
1.8	1.798	108	4	02.2009-09.2012	2ZR-FAE	; Position: Intake Manifold	EPBMPN3-V025Z	94855	10	138,7
2.0 D-4D	1.998	93	4	10.2006-09.2012	1AD-FTV		EPBMBN3-V005Z	90946	27,8	400
2.2 D	2.231	130	4	11.2006-09.2012	2AD-FHV		EPBMBN3-V005Z	90946	27,8	400

AURIS (_E18_)

1.3	1.329	73	4	10.2012-12.2018	1NR-FE		EPBMPN3-V025Z	94855	10	138,7
1.4 D-4D	1.364	66	4	10.2012-12.2018	1ND-TV		EPBMBN3-V005Z	90946	27,8	400
1.6	1.598	97	4	10.2012-12.2018	1ZR-FAE		EPBMPN3-V025Z	94855	10	138,7
1.8 Hybrid	1.798	73	4	10.2012-12.2018	2ZR-FXE	; Position: Intake Manifold	EPBMPN4-A023Z	91984	11,2	307,2
2.0 D-4D	1.998	91	4	10.2012-04.2015	1AD-FTV		EPBMBN3-V005Z	90946	27,8	400

AVENSIS (_T25_)

2.0 D-4D	1.998	93	4	03.2006-11.2008	1AD-FTV		EPBMBN3-V005Z	90946	27,8	400
----------	-------	----	---	-----------------	---------	--	---------------	-------	------	-----



MAP



l kW
C
Y
I



Type-N°

Stock-N°

kPa from

kPa to

TOYOTA

AVENSIS (_T25_)

2.2 D-4D	2.231	110	4	10.2005-11.2008	2AD-FTV		EPBMBN3-V005Z	90946	27,8	400
2.2 D-CAT	2.231	130	4	07.2005-11.2008	2AD-FHV		EPBMBN3-V005Z	90946	27,8	400

AVENSIS (_T27_)

1.6	1.598	97	4	11.2008-10.2018	1ZR-FAE		EPBMPN3-V025Z	94855	10	138,7
1.8	1.798	108	4	11.2008-10.2018	2ZR-FAE		EPBMPN3-V025Z	94855	10	138,7
2.0 D-4D	1.998	91	4	11.2011-10.2018	1AD-FTV		EPBMBN3-V005Z	90946	27,8	400
2.0 D-4D	1.998	93	4	11.2008-10.2018	1AD-FTV		EPBMBN3-V005Z	90946	27,8	400
2.0	1.987	112	4	11.2008-10.2018	3ZR-FAE, 3ZR-FE		EPBMPN3-V025Z	94855	10	138,7
2.2 D-4D	2.231	110	4	11.2008-10.2018	2AD-FHV, 2AD-FTV		EPBMBN3-V005Z	90946	27,8	400
2.2 D-4D	2.231	130	4	11.2008-10.2018	2AD-FHV		EPBMBN3-V005Z	90946	27,8	400

AYGO (_B1_)

1.0	998	50	3	07.2005-05.2014	1KR-FE		EPBMPT4-A030Z	96501	10	130
1.0 GPL	998	50	3	07.2005-05.2014	1KR-FE		EPBMPT4-A030Z	96501	10	130
1.0 VVTi	998	50	3	07.2005-05.2014	1KR-FE		EPBMPT4-A030Z	96501	10	130
1.4 Hdi	1.398	40	4	07.2005-08.2010	2WZ-TV		EPBBPN3-A006Z	91736	10	240

CAMRY (_V5_, _V7_, _VA7_, _VH7_)

2.0	1.998	110	4	01.2015-	6AR-FSE		EPBMPN3-V025Z	94855	10	138,7
-----	-------	-----	---	----------	---------	--	---------------	-------	----	-------

C-HR (_X1_)

1.8 Hybrid	1.798	72	4	10.2016-	2ZR-FXE		EPBMPN3-V025Z	94855	10	138,7
1.8 Hybrid	1.798	90	4	10.2016-	2ZR-FXE		EPBMPN3-V025Z	94855	10	138,7
2.0	1.987	109	4	11.2016-	3ZR-FAE		EPBMPN3-V025Z	94855	10	138,7

COROLLA (_E12_)

1.4 D	1.364	66	4	07.2004-02.2007	1ND-TV		EPBMBN3-V004Z	90962	10	270,3
1.4 D4-D	1.364	66	4	06.2004-10.2007	1ND-TV		EPBMBN3-V004Z	90962	10	270,3
1.8 Hybrid	1.798	72	4	10.2018-	2ZR-FXE		EPBMPN3-V025Z	94855	10	138,7

COROLLA (_E15_)

1.33	1.329	74	4	12.2008-07.2014	1NR-FE		EPBMPN3-V025Z	94855	10	138,7
1.4 D-4D	1.364	66	4	-12.2008	1ND-TV		EPBMBN3-V004Z	90962	10	270,3
1.4 D-4D	1.364	66	4	01.2009-	1ND-TV		EPBMBN3-V005Z	90946	27,8	400
1.6 Dual VVTi	1.598	91	4	01.2007-07.2014	1ZR-FE		EPBMPN3-V025Z	94855	10	138,7
1.6 VVTi	1.598	100	4	03.2007-12.2010	1ZR-FE		EPBMPN3-V025Z	94855	10	138,7
2.0 D-4D	1.998	93	4	11.2006-07.2014	1AD-FTV		EPBMBN3-V005Z	90946	27,8	400

COROLLA (_E18_, _ZRE1_)

1.3	1.329	73	4	06.2013-12.2018	1NR-FE		EPBMPN3-V025Z	94855	10	138,7
1.4 D-4D	1.364	66	4	06.2013-12.2018	1ND-TV		EPBMBN3-V005Z	90946	27,8	400
1.6	1.598	90	4	06.2013-12.2018	1ZR-FE		EPBMPN3-V025Z	94855	10	138,7
1.6	1.598	97	4	06.2013-12.2018	1ZR-FAE		EPBMPN3-V025Z	94855	10	138,7

COROLLA (_E21_)

1.6 VVTi	1.598	90	4	01.2019-	1ZR-FE, 1ZR-FAE		EPBMPN3-V025Z	94855	10	138,7
----------	-------	----	---	----------	-----------------	--	---------------	-------	----	-------



MAP



l kW
C
Y
I



Type-N°

Stock-N°

kPa from

kPa to

TOYOTA

COROLLA (_E21_)

1.6 VVTi	1.598	97	4	01.2019-	1ZR-FE, 1ZR-FAE		EPBMPN3-V025Z	94855	10	138,7
1.8 VVTi Hybrid	1.798	72	4	01.2019-	2ZR-FXE		EPBMPN3-V025Z	94855	10	138,7

COROLLA VERSO (ZER_, ZZE12_, R1_)

2.2 D-4D	2.231	100	4	10.2005-03.2009	2AD-FTV		EPBMBN3-V005Z	90946	27,8	400
2.2 D-4D	2.231	130	4	10.2005-03.2009	2AD-FHV		EPBMBN3-V005Z	90946	27,8	400

DYNA (KD_, LY_, _Y2_, _U3_, _U4_)

2.5 D4d	2.494	65	4	01.2005-	2KD-FTV	; Position: Throttle Housing	EPBMBN3-V004Z	90962	10	270,3
2.5 D4d	2.494	75	4	01.2005-	2KD-FTV	; Position: Throttle Housing	EPBMBN3-V004Z	90962	10	270,3
4.0 D4d	4.009	110	4	10.2006-	N04C-TQ, N04C-UL, N04C-UP	; For ASR; Type: XZU4; Type: XZU7; PictogramS:	EPBMPN3-V025Z	94855	10	138,7
4.0 D4d 4WD	4.009	110	4	05.2011-	N04C-UL	; For ASR; Type: XZU4; Type: XZU7; PictogramS:	EPBMPN3-V025Z	94855	10	138,7
4.0 D4d 4WD	4.009	110	4	05.2011-	N04C-UP	; For ASR; Type: XZU4; Type: XZU7; 2↑	EPBMPN3-V025Z	94855	10	138,7

DYNA 400 (BU_, XZU_)

4.6 Tdi	4.613	108	4	06.2003-09.2006	S05C-TB	; PictogramS:	EPBMPN3-V025Z	94855	10	138,7
---------	-------	-----	---	-----------------	---------	---------------	---------------	-------	----	-------

HIACE IV (_H1_, _H2_)

2.5 D-4D	2.494	65	4	08.2006-	2KD-FTV		EPBMBN3-V005Z	90946	27,8	400
2.5 D-4D	2.494	70	4	09.2006-12.2012	2KD-FTV		EPBMBN3-V005Z	90946	27,8	400
2.5 D-4D	2.494	75	4	08.2006-	2KD-FTV		EPBMBN3-V005Z	90946	27,8	400
2.5 D-4D 4WD	2.494	75	4	08.2006-	2KD-FTV		EPBMBN3-V005Z	90946	27,8	400
2.5 D-4D	2.494	86	4	08.2006-12.2012	2KD-FTV		EPBMBN3-V005Z	90946	27,8	400
2.5 D-4D 4WD	2.494	86	4	09.2006-12.2012	2KD-FTV		EPBMBN3-V005Z	90946	27,8	400

HIACE V (TRH2_, KDH2_, LH2_) | QUANTUM

2.5 D-4D	2.494	70	4	09.2006-	2KD-FTV		EPBMBN3-V004Z	90962	10	270,3
2.5 D-4D	2.494	75	4	06.2004-	2KD-FTV		EPBMBN3-V004Z	90962	10	270,3
2.5 D-4D	2.494	86	4	09.2006-	2KD-FTV		EPBMBN3-V004Z	90962	10	270,3
2.5 D-4D 4WD	2.494	94	4	08.2004-09.2007	2KD-FTV		EPBMBN3-V004Z	90962	10	270,3
3.0 D	2.982	80	4	08.2004-	1KD-FTV		EPBMBN3-V005Z	90946	27,8	400
3.0 D	2.982	100	4	05.2010-	1KD-FTV		EPBMBN3-V005Z	90946	27,8	400

IQ (_J1_)

1.0	998	50	3	01.2009-12.2015	1KR-FE		EPBMPT4-A030Z	96501	10	130
1.33	1.329	72	4	01.2009-12.2015	1NR-FE		EPBMPT4-A030Z	96501	10	130
1.4 D-4D	1.364	66	4	01.2009-12.2015	1ND-TV		EPBMBN3-V005Z	90946	27,8	400

LAND CRUISER 200 (_J2_)

4.5 D4-D	4.461	173	8	08.2007-	1VD-FTV		EPBMBN3-V005Z	90946	27,8	400
4.5 D4-D	4.461	195	8	09.2007-	1VD-FTV		EPBMBN3-V005Z	90946	27,8	400
4.5 D4-D	4.461	200	8	01.2012-	1VD-FTV		EPBMBN3-V005Z	90946	27,8	400
4.5 D V8	4.461	210	8	01.2008-	1VD-FTV		EPBMBN3-V005Z	90946	27,8	400
4.6 V8	4.608	227	8	09.2010-	1UR-FE	; Position: Intake Manifold	EPBMPN4-A023Z	91984	11,2	307,2



MAP



l kW
C
Y
I



Type-Nº

Stock-Nº

kPa from

kPa to

TOYOTA

LAND CRUISER 200 (_J2_)

4.6 V8	4.608	234	8	01.2012-	1UR-FE		EPBMPN4-A023Z	91984	11,2	307,2
--------	-------	-----	---	----------	--------	--	---------------	-------	------	-------

LAND CRUISER PRADO (_J12_)

3.0 D-4D	2.982	120	4	08.2004-08.2006	1KD-FTV		EPBMBN3-V004Z	90962	10	270,3
3.0 D-4D	2.982	120	4	08.2006-	1KD-FTV		EPBMBN3-V005Z	90946	27,8	400
3.0 D-4D	2.982	122	4	08.2004-08.2006	1KD-FTV		EPBMBN3-V004Z	90962	10	270,3
3.0 D-4D	2.982	122	4	08.2006-	1KD-FTV		EPBMBN3-V005Z	90946	27,8	400
3.0 D-4D	2.982	127	4	08.2004-08.2006	1KD-FTV		EPBMBN3-V004Z	90962	10	270,3
3.0 D-4D	2.982	127	4	08.2006-	1KD-FTV		EPBMBN3-V005Z	90946	27,8	400

LAND CRUISER PRADO (_J15_)

3.0 D-4D	2.982	127	4	08.2009-	1KD-FTV		EPBMBN3-V005Z	90946	27,8	400
3.0 D-4D	2.982	140	4	08.2009-	1KD-FTV		EPBMBN3-V005Z	90946	27,8	400

PRIUS (_W3_)

1.8 Hybrid	1.798	73	4	-10.2009	2ZR-FXE		EPBMPT4-A030Z	96501	10	130
1.8 Hybrid	1.798	73	4	11.2009-	2ZR-FXE		EPBMPN4-A023Z	91984	11,2	307,2
1.8 Plug-in Hybrid	1.798	73	4	01.2012-	2ZR-FXE		EPBMPN4-A023Z	91984	11,2	307,2
1.8 Hybrid	1.798	100	4	-10.2009	2ZR-FXE		EPBMPT4-A030Z	96501	10	130
1.8 Hybrid	1.798	100	4	11.2009-	2ZR-FXE		EPBMPN4-A023Z	91984	11,2	307,2

PRIUS (_W5_)

1.8 Hybrid	1.798	72	4	09.2015-	2ZR-FXE		EPBMPN3-V025Z	94855	10	138,7
1.8 Hybrid E-Four 4WD	1.798	72	4	09.2015-	2ZR-FXE		EPBMPN3-V025Z	94855	10	138,7

PRIUS C (NHP10_)

1.5 Hybrid	1.497	54	4	12.2011-	1NZFXE	; Position: Intake Manifold	EPBMPN4-A023Z	91984	11,2	307,2
------------	-------	----	---	----------	--------	-----------------------------	---------------	-------	------	-------

PRIUS PHV (_W52_)

1.8 Plug-in Hybrid	1.798	72	4	01.2016-	2ZR-FXE		EPBMPN3-V025Z	94855	10	138,7
--------------------	-------	----	---	----------	---------	--	---------------	-------	----	-------

PRIUS PLUS (_W4_) | GRAND PRIUS +

1.8 Hybrid	1.798	73	4	05.2011-	2ZR-FXE		EPBMPN4-A023Z	91984	11,2	307,2
------------	-------	----	---	----------	---------	--	---------------	-------	------	-------

RAV 4 III (_A3_)

2.0	1.987	109	4	03.2009-06.2013	3ZR-FAE		EPBMPN3-V025Z	94855	10	138,7
2.0 4WD	1.987	109	4	03.2009-06.2013	3ZR-FAE		EPBMPN3-V025Z	94855	10	138,7
2.0	1.987	116	4	12.2008-06.2013	3ZR-FAE		EPBMPN3-V025Z	94855	10	138,7
2.0 4WD	1.987	116	4	12.2008-06.2013	3ZR-FAE		EPBMPN3-V025Z	94855	10	138,7
2.2 D 4WD	2.231	100	4	02.2006-12.2012	2AD-FTV		EPBMBN3-V005Z	90946	27,8	400
2.2 D	2.231	110	4	12.2008-06.2013	2AD-FHV, 2AD-FTV		EPBMBN3-V005Z	90946	27,8	400
2.2 D 4WD	2.231	110	4	12.2008-06.2013	2AD-FHV, 2AD-FTV		EPBMBN3-V005Z	90946	27,8	400
2.2 D 4WD	2.231	130	4	02.2006-06.2013	2AD-FHV		EPBMBN3-V005Z	90946	27,8	400

RAV 4 IV (_A4_)

2.0 D	1.998	91	4	12.2012-11.2018	1AD-FTV		EPBMBN3-V005Z	90946	27,8	400
2.0 D 4WD	1.998	91	4	01.2013-11.2018	1AD-FTV		EPBMBN3-V005Z	90946	27,8	400
2.0	1.987	105	4	12.2012-	3ZR-FE		EPBMPN3-V025Z	94855	10	138,7



MAP



l kW
C
Y
I



Type-Nº

Stock-Nº

kPa from

kPa to

TOYOTA

RAV 4 IV (_A4_)

2.0	1.987	107	4	12.2012-	3ZR-FE		EPBMPN3-V025Z	94855	10	138,7
2.0 4WD	1.987	111	4	12.2012-	3ZR-FAE		EPBMPN3-V025Z	94855	10	138,7
2.0 4WD	1.987	112	4	04.2015-	3ZR-FAE		EPBMPN3-V025Z	94855	10	138,7
2.2 D 4WD	2.231	110	4	12.2012-	2AD-FHV, 2AD-FTV		EPBMBN3-V005Z	90946	27,8	400
2.5 Hybrid	2.494	114	4	10.2015- 11.2018	2AR-FXE		EPBMPN3-V025Z	94855	10	138,7
2.5 Hybrid 4WD	2.494	114	4	10.2015- 12.2018	2AR-FXE		EPBMPN3-V025Z	94855	10	138,7
2.5 Hybrid	2.494	145	4	11.2015- 11.2018	2AR-FXE		EPBMPN3-V025Z	94855	10	138,7

URBAN CRUISER (_P1_)

1.33	1.329	73	4	01.2009- 03.2016	1NR-FE		EPBMPN3-V025Z	94855	10	138,7
1.33	1.329	74	4	04.2009- 03.2016	1NR-FE		EPBMPN3-V025Z	94855	10	138,7
1.4 D-4D	1.364	66	4	01.2009- 04.2014	1ND-TV		EPBMBN3-V005Z	90946	27,8	400
1.4 D-4D 4WD	1.364	66	4	01.2009- 04.2014	1ND-TV		EPBMBN3-V005Z	90946	27,8	400

VERSO (_R2_)

1.6	1.598	97	4	04.2009- 08.2018	1ZR-FAE		EPBMPN3-V025Z	94855	10	138,7
1.8	1.798	108	4	04.2009- 08.2018	2ZR-FAE	; Position: Intake Manifold	EPBMPN3-V025Z	94855	10	138,7
2.0 D-4D	1.998	91	4	11.2012- 08.2018	1AD-FTV		EPBMBN3-V005Z	90946	27,8	400
2.0 D-4D	1.998	93	4	04.2009- 08.2018	1AD-FTV		EPBMBN3-V005Z	90946	27,8	400
2.2 D-4D	2.231	110	4	04.2009- 08.2018	2AD-FHV		EPBMBN3-V005Z	90946	27,8	400
2.2 D-CAT	2.231	130	4	04.2009- 08.2018	2AD-FHV		EPBMBN3-V005Z	90946	27,8	400

VERSO S (_P12_) | VERSO SPACE

1.33	1.329	73	4	11.2010- 10.2016	1NR-FE	; Position: Intake Manifold	EPBMPN3-V025Z	94855	10	138,7
1.4 D4-D	1.364	66	4	11.2010- 10.2016	1ND-TV		EPBMBN3-V005Z	90946	27,8	400

YARIS (_P13_) | YARIS/VITZ

1.0	998	51	3	12.2010-	1KR-FE		EPBMPT4-A030Z	96501	10	130
1.3 VVTi	1.329	73	4	09.2011-	1NR-FE		EPBMPN3-V025Z	94855	10	138,7
1.4 D	1.364	66	4	09.2011-	1ND-TV		EPBMBN3-V005Z	90946	27,8	400
1.5 Hybrid	1.497	55	4	03.2012-	1NZ-FXE		EPBMPN4-A023Z	91984	11,2	307,2
1.5 VVTi	1.496	82	4	03.2017-	2NR-FKE		EPBMPN4-A023Z	91984	11,2	307,2

YARIS (_P9_)

1.0 VVT-i	998	51	3	08.2005- 12.2011	1KR-FE		EPBMPT4-A030Z	96501	10	130
1.0 GPL	998	51	3	01.2006- 12.2011	1KR-FE		EPBMPT4-A030Z	96501	10	130
1.0	998	52	3	09.2005- 10.2013	1KR-FE	; Position: Intake Manifold	EPBMPT4-A030Z	96501	10	130
1.33 VVT-i	1.329	74	4	11.2008- 12.2011	1NR-FE		EPBMPN3-V025Z	94855	10	138,7
1.4 D-4D	1.364	66	4	-11.2008	1ND-TV		EPBMBN3-V004Z	90962	10	270,3
1.4 D-4D	1.364	66	4	11.2008-	1ND-TV		EPBMBN3-V005Z	90946	27,8	400

VAUXHALL

ADAM (M13)

1.2	1.229	51	4	10.2012- 02.2019	A12XEL, B12XEL		EPBMPN3-V017Z	91253	10	120
-----	-------	----	---	---------------------	----------------	--	---------------	-------	----	-----



MAP



l kW
C
Y
I



Type-N°

Stock-N°

kPa from
kPa to

VAUXHALL

ADAM (M13)

1.4	1.398	64	4	10.2012-02.2019	A14XEL		EPBMPN3-V017Z	91253	10	120
1.4	1.398	74	4	10.2012-02.2019	A14XER		EPBMPN3-V017Z	91253	10	120
1.4 S	1.364	110	4	11.2014-01.2019	B14NEH		EPBBPN3-V029Z	92983	20	270

AGILA MK II (B) (H08)

1.0 12V	996	48	3	01.2008-11.2014	K10B	; Chass. <BM999999	EPBMPN3-V026Z	94423	10	117,9
1.0 i	996	50	3	08.2011-11.2014	K10B	; Chass. <BM999999	EPBMPN3-V026Z	94423	10	117,9
1.2 i 16V	1.242	63	4	01.2008-11.2014	K12B	; Chass. <AM999999	EPBMPN3-V026Z	94423	10	117,9
1.2 i 16V	1.242	69	4	01.2008-11.2014	K12B	; Chass. <AM999999	EPBMPN3-V026Z	94423	10	117,9

AMPERA (R12)

EV 150 (D1JOI)	1.398	111	4	03.2012-	A14XFL		EPBMPN3-V017Z	91253	10	120
EV 150 (D1JOI)	1.398	111	4	03.2012-	4ET50	; Position: Intake Manifold	EPBMPN3-V017Z	91253	10	120

ANTARA (L07)

2.4	2.384	123	4	12.2010-04.2015	A24XE, A24XF		EPBMPN3-V017Z	91253	10	120
2.4 4x4	2.384	123	4	12.2010-04.2015	A24XE, A24XF		EPBMPN3-V017Z	91253	10	120

ASTRA MK IV (G) (T98)

1.4 16V	1.389	66	4	09.1998-05.2005	X14XE, Z14XE		EPBMPN3-V005Z	93871	20	100
1.6	1.598	62	4	03.1998-08.2006	Z16SE		EPBMPN3-V005Z	93871	20	100
1.6 Dualfuel	1.598	62	4	09.2000-10.2004	Z16SE		EPBMPN3-V005Z	93871	20	100
1.6 Dualfuel	1.598	63	4	03.1998-05.2005	Z16SE		EPBMPN3-V005Z	93871	20	100
1.6 Dualfuel	1.598	74	4	09.1999-08.2005	Z16XE, Z16XE		EPBMPN3-V005Z	93871	20	100
1.6 16V	1.598	74	4	09.1998-05.2005	X16XEL, Z16XE, Z16XEP		EPBMPN3-V005Z	93871	20	100
1.6 16V	1.598	76	4	03.2000-10.2005	Z16XEP		EPBMPN3-V005Z	93871	20	100
1.6 Dualfuel 16V	1.598	77	4	10.2004-12.2005	Z16XEP		EPBMPN3-V005Z	93871	20	100
1.7 TD	1.700	50	4	02.1998-08.2006	X17DTL		EPBBPN3-A015Z	96911	20	250
1.7 DTI 16V	1.686	55	4	02.2000-08.2006	Y17DT		EPBMPN3-V006Z	97501	30	190
1.7 CDTI 16V	1.686	59	4	04.2003-08.2006	Z17DTL	; Position: Intake Manifold	EPBBPN3-V010Z	95936	20	250
2.0 DI	1.995	60	4	02.1998-08.2006	X20DTL, Y20DTL		EPBBPN3-A015Z	96911	20	250
2.0 DTI	1.995	74	4	04.2004-08.2006	Y20DTH	; Chass. <YH999999	EPBBPN3-A015Z	96911	20	250
2.0 DTI	1.995	74	4	04.2004-08.2006	Y20DTH	; Chass. >12000001; Chass. <2H999999	EPBBPN3-A012Z	91308	25	290
2.0 DTI 16V	1.995	74	4	08.1998-05.2005	Y20DTH	; Chass. <Y2999999; Chass. <Y5999999; Chass. <Y6999999; Chass. <Y8999999; Chass. <YB999999; Chass. <YG; Chass. <YH999999	EPBBPN3-A015Z	96911	20	250
2.0 DTI 16V	1.995	74	4	03.1999-05.2005	Y20DTH	; Chass. <22999999; Chass. <25999999; Chass. <26999999; Chass. <28999999; Chass. <2B999999; Chass. <2G; Chass. <2H999999	EPBBPN3-A012Z	91308	25	290
2.0 16V Turbo	1.998	140	4	09.2000-08.2005	Z20LET		EPBBPT4-V010Z	91257	20	250
2.0 SRI Turbo	1.998	141	4	11.2001-10.2005	Z20LET		EPBBPT4-V010Z	91257	20	250





















VAUXHALL

















ASTRA MK IV (G) (T98)

2.0	1.998	147	4	08.2002-10.2005	Z20LET		EPBBPT4-V010Z	91257	20	250
2.2 16V	2.198	108	4	03.2000-10.2005	Z22SE		EPBMPN3-V005Z	93871	20	100

ASTRA MK V (H) (A04)

1.6	1.598	76	4	03.2005-	Z16XEP, Z16XE1		EPBMPN3-V005Z	93871	20	100
1.6	1.598	77	4	01.2004-11.2010	Z16XEP	 ; Chass. <72999999; Chass. <75999999; Chass. <78999999; Chass. <7G; not for POC (WEM)	EPBMPN3-V005Z	93871	20	100
1.6	1.598	77	4	01.2004-11.2010	Z16XEP	 ; Chass. >72000001; Chass. >75000001; Chass. >78000001; Chass. <7G; for POC (WEM)	EPBMPN3-V017Z	91253	10	120
1.6	1.598	85	4	08.2004-03.2011	A16XER		EPBMPN3-V005Z	93871	20	100
1.6	1.598	85	4	08.2004-03.2011	A16XER		EPBMPN3-V017Z	91253	10	120
1.6 i 16V	1.598	85	4	01.2004-08.2011	Z16XER, A16XER		EPBMPN3-V041Z	92257	10	121,7
1.6 Turbo	1.598	132	4	08.2004-11.2010	Z16LET		EPBMPN3-A028Z	93480	10	115
1.7 CDTi	1.686	59	4	01.2004-05.2009	Z17DTL		EPBBPN3-V010Z	95936	20	250
1.7 CDTi	1.686	74	4	01.2004-11.2011	Z17DTH		EPBBPN3-V010Z	95936	20	250
1.7 CDTi	1.686	81	4	01.2004-10.2012	A17DTJ, Z17DTJ		EPBMBT4-A002Z	92144	30,8	369,2
1.8	1.796	103	4	01.2004-11.2010	A18XER		EPBMPN3-V017Z	91253	10	120
1.8	1.796	103	4	01.2004-11.2010	Z18XER		EPBMPN3-V041Z	92257	10	121,7
1.8 i 16V	1.796	103	4	03.2007-11.2010	A18XER		EPBMPN3-V017Z	91253	10	120
1.8 i 16V	1.796	103	4	03.2007-11.2010	Z18XER		EPBMPN3-V041Z	92257	10	121,7
2.0 Turbo	1.998	125	4	01.2004-11.2010	Z20LEL		EPBMPN3-A028Z	93480	10	115
2.0 Turbo	1.998	147	4	01.2004-11.2010	Z20LER		EPBMPN3-A028Z	93480	10	115
2.0 VXR	1.998	176	4	02.2009-11.2010	Z20LEH		EPBMPN3-A028Z	93480	10	115
2.0 Turbo	1.998	177	4	01.2004-05.2009	Z20LEH		EPBMPN3-A028Z	93480	10	115

ASTRA MK VI (J) (P10)

1.4	1.398	64	4	12.2009-10.2015	A14XEL	 ; Position: Intake Manifold	EPBMPN3-V017Z	91253	10	120
1.4	1.398	74	4	12.2009-10.2015	A14XER, B14XER		EPBMPN3-V017Z	91253	10	120
1.4 Turbo	1.364	88	4	08.2010-10.2015	A14NEL, B14NEL	 ; 	EPBMPN3-V017Z	91253	10	120
1.4 Turbo	1.364	88	4	08.2010-10.2015	A14NEL, B14NEL	 ; 	EPBBPN3-V029Z	92983	20	270
1.4 Turbo	1.364	103	4	10.2010-10.2015	A14NET	 ; Chass. <BG999999; Chass. <B8999999; Chass. <B3999999	EPBBPT4-V010Z	91257	20	250
1.4 Turbo	1.364	103	4	10.2010-10.2015	A14NET	 ; Position: Intake Manifold	EPBMPN3-V017Z	91253	10	120
1.4 Turbo	1.364	103	4	10.2010-10.2015	A14NET	 ; Position: Intake Manifold	EPBBPN3-V029Z	92983	20	270
1.4 Turbo	1.364	103	4	10.2011-10.2015	A14NET, B14NET	 ; 	EPBBPN3-V029Z	92983	20	270
1.4 Turbo	1.364	103	4	12.2009-10.2015	A14NET, B14NET	 ; 	EPBMPN3-V017Z	91253	10	120
1.4 Turbo	1.364	103	4	12.2009-10.2015	A14NET, B14NET	 ; Position: Left	EPBBPN3-V029Z	92983	20	270
1.6	1.598	85	4	12.2009-10.2015	A16XER, B16XER		EPBMPN3-V017Z	91253	10	120
1.6 Turbo	1.598	132	4	12.2009-10.2015	A16LET		EPBBPT4-V010Z	91257	20	250

MAP



l kW
C
Y
I



Type-N°

Stock-N°

kPa from
kPa to

VAUXHALL

ASTRA MK VI (J) (P10)

1.6 Turbo	1.598	132	4	12.2009-10.2015	A16LET	; Position: Intake Manifold	EPBMPN3-V017Z	91253	10	120
1.6 Turbo	1.598	132	4	12.2009-10.2015	A16LET	; Position: Intake Manifold	EPBBPN3-V029Z	92983	20	270
1.6 Turbo	1.598	132	4	10.2010-10.2015	A16LET	;	EPBMPN3-V017Z	91253	10	120
1.6 Turbo	1.598	132	4	10.2010-10.2015	A16LET	;	EPBBPN3-V029Z	92983	20	270
1.6 Turbo	1.598	132	4	06.2012-10.2015	A16LET		EPBBPN3-V029Z	92983	20	270
1.7 CDTi	1.686	81	4	12.2009-10.2015	A17DTC, A17DTE, A17DTJ		EPBMBT4-A002Z	92144	30,8	369,2
1.7 CDTi	1.686	92	4	12.2009-10.2015	A17DTR		EPBMBT4-A002Z	92144	30,8	369,2

CASCADA (W13)

1.4	1.364	103	4	02.2013-	A14NET		EPBBPN3-V029Z	92983	20	270
1.4	1.364	103	4	02.2013-	B14NET	; Position: Intake Manifold	EPBBPN3-V029Z	92983	20	270

COMBO MK II (C) (F25)

1.4 16V	1.389	66	4	10.2001-05.2007	Z14XE		EPBMPN3-V005Z	93871	20	100
1.6	1.598	62	4	09.2001-10.2004	Z16SE		EPBMPN3-V005Z	93871	20	100
1.6	1.598	64	4	10.2001-11.2011	Z16SE		EPBMPN3-V005Z	93871	20	100
1.6 CNG 16V	1.598	69	4	06.2006-02.2012	Z16YNG		EPBMPN3-V005Z	93871	20	100
1.6 CNG 16V	1.598	71	4	04.2005-02.2012	Z16YNG		EPBMPN3-V005Z	93871	20	100
1.7 DI 16V	1.686	48	4	09.2001-11.2011	Y17DTL		EPBMPN3-V006Z	97501	30	190
1.7 DTI 16V	1.686	55	4	10.2001-02.2012	Y17DT		EPBMPN3-V006Z	97501	30	190
1.7 CDTI 16V	1.686	74	4	12.2004-11.2011	Z17DTH		EPBBPN3-V010Z	95936	20	250

CORSA MK II (C) (X01)

1.4 16V	1.389	66	4	09.2000-10.2006	Z14XE		EPBMPN3-V005Z	93871	20	100
1.7 DI 16V	1.686	48	4	08.2000-09.2006	Y17DTL		EPBMPN3-V006Z	97501	30	190
1.7 DTI 16V	1.686	55	4	08.2000-09.2006	Y17DT		EPBMPN3-V006Z	97501	30	190
1.7 CDTI 16V	1.686	74	4	08.2000-09.2006	Z17DTH		EPBBPN3-V010Z	95936	20	250

CORSA MK III (D) (S07)

1.0	998	44	3	08.2006-08.2014	Z10XEP		EPBMPN3-V010Z	93991	10	117,5
1.0	998	44	3	08.2006-08.2014	A10XEP	; Position: Intake Manifold	EPBMPN3-V017Z	91253	10	120
1.0 i 12V	998	48	3	01.2010-08.2014	A10XEP	; Position: Intake Manifold	EPBMPN3-V017Z	91253	10	120
1.2	1.229	59	4	08.2006-08.2014	Z12XEP		EPBMPN3-V010Z	93991	10	117,5
1.2 LPG	1.229	59	4	09.2009-08.2014	Z12XEP		EPBMPN3-V010Z	93991	10	117,5
1.2 LPG	1.229	63	4	08.2011-08.2014	A12XER		EPBMPN3-V017Z	91253	10	120
1.2 i 16V	1.229	63	4	12.2009-08.2014	A12XER	; Position: Intake Manifold	EPBMPN3-V017Z	91253	10	120
1.4 LPG	1.364	66	4	07.2006-08.2014	Z14XEP		EPBMPN3-V010Z	93991	10	117,5
1.4	1.364	66	4	08.2006-08.2014	Z14XEP		EPBMPN3-V010Z	93991	10	117,5
1.4	1.398	74	4	01.2010-08.2014	A14XER	; Position: Intake Manifold	EPBMPN3-V017Z	91253	10	120
1.4	1.364	88	4	08.2012-08.2014	A14NEL		EPBBPN3-V029Z	92983	20	270
1.6 Sri	1.598	110	4	05.2007-08.2014	A16LEL		EPBMPN3-V017Z	91253	10	120



VAUXHALL





CORSA MK III (D) (S07)

1.6 VXR	1.598	141	4	11.2006-08.2014	A16LER, B16LER, Z16LER		EPBMPN3-A028Z	93480	10	115
1.6 VXR	1.598	150	4	06.2011-08.2014	A16LES		EPBMPN3-A028Z	93480	10	115
1.6 VXR	1.598	150	4	06.2011-08.2014	Z16LER		EPBBPT4-V010Z	91257	20	250
1.6 VXR	1.598	150	4	06.2011-08.2014	Z16LER	 ; Position: Intake Manifold	EPBMPN3-A028Z	93480	10	115
1.6 VXR	1.598	154	4	06.2011-08.2014	A16LES		EPBMPN3-A028Z	93480	10	115
1.6 VXR	1.598	154	4	06.2011-08.2014	A16LES		EPBMPN3-V017Z	91253	10	120
1.6 VXR	1.598	155	4	06.2011-03.2012	A16LES		EPBMPN3-A028Z	93480	10	115
1.6 VXR	1.598	155	4	06.2011-03.2012	A16LES		EPBMPN3-V017Z	91253	10	120













CORSA MK IV (E) (X15)

1.2	1.229	51	4	08.2014-	B12XEL		EPBMPN3-V017Z	91253	10	120
1.4	1.398	55	4	09.2014-	B14XEJ		EPBMPN3-V017Z	91253	10	120
1.4	1.398	66	4	08.2014-	B14XEL		EPBMPN3-V017Z	91253	10	120
1.4	1.398	66	4	08.2014-	B14XEJ	 ; Position: Intake Manifold	EPBMPN3-V017Z	91253	10	120
1.4	1.364	74	4	08.2014-	B14NEJ		EPBBPN3-V029Z	92983	20	270
1.4	1.364	110	4	07.2015-	B14NEH		EPBBPN3-V029Z	92983	20	270
1.6 VXR	1.598	151	4	04.2015-	B16LES	 	EPBMPN3-V017Z	91253	10	120
1.6 VXR	1.598	151	4	04.2015-	B16LES	 	EPBBPN3-V029Z	92983	20	270

FRONTERA MK II (B) (U99)

2.2 DTI	2.171	85	4	10.1998-09.2004	X22DTH, Y22DTH	 ; Chass. <2V599999	EPBMPN3-A028Z	93480	10	115
2.2 DTI	2.171	85	4	10.1998-09.2004	X22DTH, Y22DTH	 ; Chass. <2V599999	EPBBPN3-A015Z	96911	20	250
2.2 DTI	2.171	88	4	09.2000-10.2004	Y22DTH	 ; Chass. <2V599999	EPBBPN3-A015Z	96911	20	250
2.2 DTI	2.171	88	4	09.2000-10.2004	Y22DTH	 ; Chass. <2V599999	EPBMPN3-A028Z	93480	10	115
2.2 i	2.198	100	4	10.1998-10.2004	X22SE, Y22SE		EPBMPN3-V005Z	93871	20	100
3.2 i	3.165	151	6	10.1998-10.2004	6VD1, Y32NE		EPBMPN3-V005Z	93871	20	100

INSIGNIA MK I (A) (G09)

1.4 LPG	1.364	103	4	07.2012-05.2017	A14NET	 ; Position: Left	EPBBPN3-V029Z	92983	20	270
1.4	1.364	103	4	04.2011-05.2017	A14NET, B14NET	 	EPBBPN3-V029Z	92983	20	270
1.6	1.598	85	4	07.2008-07.2012	A16XER		EPBMPN3-V017Z	91253	10	120
1.6 Turbo	1.598	132	4	01.2009-05.2017	A16LET		EPBMPN3-V017Z	91253	10	120
1.8	1.796	103	4	07.2008-05.2017	A18XER		EPBMPN3-V017Z	91253	10	120
1.8	1.796	103	4	07.2008-05.2017	B18XER	 ; Position: Intake Manifold	EPBMPN3-V017Z	91253	10	120
2.0 Turbo	1.998	162	4	07.2008-05.2017	A20NFT, A20NHT		EPBMPN3-A044Z	93056		
2.0 Turbo 4x4	1.998	162	4	07.2008-05.2017	A20NHT		EPBMPN3-A044Z	93056		
2.0 Turbo	1.998	184	4	07.2011-05.2017	A20NFT	 ; Position: Air Filter Housing	EPBMPN3-V017Z	91253	10	120
2.0 Turbo	1.998	184	4	07.2011-05.2017	A20NHT, B20NHT		EPBMPN3-A044Z	93056		
2.0 Turbo 4x4	1.998	184	4	09.2011-05.2017	A20NFT	 ; Position: Air Filter Housing	EPBMPN3-V017Z	91253	10	120

MAP



l kW
C
Y
I



Type-N°

Stock-N°

kPa from

kPa to

VAUXHALL

MERIVA A (X03)

1.6 i	1.598	64	4	01.2003-06.2010	Z16SE		EPBMPN3-V005Z	93871	20	100
1.6 i 16V	1.598	74	4	01.2003-09.2005	Z16XE		EPBMPN3-V005Z	93871	20	100
1.6 i 16V Twinport	1.598	77	4	05.2003-06.2010	Z16XEP		EPBMPN3-V005Z	93871	20	100
1.6 Turbo	1.598	132	4	05.2006-06.2010	Z16LET		EPBMPN3-A028Z	93480	10	115
1.6 Turbo	1.598	132	4	05.2006-06.2010	Z16LET		EPBBPT4-V010Z	91257	20	250
1.7 CDTi	1.686	74	4	09.2003-08.2005	Z17DTH		EPBMPN3-V005Z	93871	20	100
1.7 CDTi	1.686	74	4	09.2003-08.2005	Z17DTH	; Position: Intake Manifold	EPBBPN3-V010Z	95936	20	250

MERIVA MK II (B) (S10)

1.4	1.398	74	4	06.2010-	A14XER, B14XER		EPBMPN3-V017Z	91253	10	120
1.4 LPG	1.364	88	4	06.2011-	A14NEL	;	EPBMPN3-V017Z	91253	10	120
1.4 LPG	1.364	88	4	06.2011-	B14NEL	; Position: Intake Manifold	EPBMPN3-V017Z	91253	10	120
1.4 LPG	1.364	88	4	06.2011-	A14NEL	; Position: Left	EPBBPN3-V029Z	92983	20	270
1.4 LPG	1.364	88	4	06.2011-	B14NEL	; Position: Intake Manifold	EPBBPN3-V029Z	92983	20	270
1.4 LPG	1.364	88	4	06.2011-	B14NEL	; Chass. <B4999999	EPBBPT4-V010Z	91257	20	250
1.4	1.364	88	4	06.2010-	A14NEL, B14NEL	;	EPBMPN3-V017Z	91253	10	120
1.4	1.364	88	4	06.2010-	A14NEL, B14NEL	; Position: Left	EPBBPN3-V029Z	92983	20	270
1.4	1.364	103	4	06.2010-	A14NET, B14NET	; Position: Left	EPBMPN3-V017Z	91253	10	120
1.4	1.364	103	4	06.2010-	A14NET, B14NET	;	EPBBPN3-V029Z	92983	20	270
1.7 CDTi	1.686	74	4	06.2010-	A17DT		EPBMBT4-A002Z	92144	30,8	369,2

MOKKA / MOKKA X (J13)

1.4	1.364	103	4	04.2013-	A14NET, B14NET, D14NET		EPBBPN3-V029Z	92983	20	270
1.4 4x4	1.364	103	4	06.2012-	A14NET, B14NET, D14NET		EPBBPN3-V029Z	92983	20	270
1.6	1.598	85	4	06.2012-	A16XER, B16XER		EPBMPN3-V017Z	91253	10	120

MONTEREY MK II (M98)

3.0 DTI	2.999	117	4	07.1998-08.1999	4JX1		EPBMPN3-A033Z	96422	20	200
3.5 V6 24V	3.494	158	6	07.1998-08.1999	6VE1		EPBMPN3-V005Z	93871	20	100

MOVANO MK I (A) (X70)

2.8 DTI	2.799	84	4	10.1998-10.2001	S9W702		EPBMPN3-A033Z	96422	20	200
---------	-------	----	---	-----------------	--------	--	---------------	-------	----	-----

MOVANO MK II (B) (X62)

2.3 CDTi FWD	2.298	74	4	05.2010-	M9T670, M9T672, M9T676		EPBBPN3-V016Z	92713	50	350
2.3 CDTi RWD	2.298	74	4	05.2010-	M9T690, M9T692		EPBBPN3-V016Z	92713	50	350
2.3 CDTi FWD	2.298	81	4	02.2012-	M9T870		EPBBPN3-V016Z	92713	50	350
2.3 CDTi FWD	2.298	92	4	05.2010-	M9T670, M9T672, M9T676, M9T680, M9T876		EPBBPN3-V016Z	92713	50	350
2.3 CDTi RWD	2.298	92	4	05.2010-	M9T686, M9T690, M9T692, M9T696, M9T698, M9T898		EPBBPN3-V016Z	92713	50	350
2.3 CDTi FWD	2.298	107	4	05.2010-	M9T678, M9T680, M9T880		EPBBPN3-V016Z	92713	50	350
2.3 CDTi RWD	2.298	107	4	07.2010-	M9T694, M9T696, M9T698, M9T896, M9T898		EPBBPN3-V016Z	92713	50	350





VAUXHALL



OMEGA (B) (V94)

2.0 DTI 16V	1.995	74	4	01.1998-09.2000	X20DTH		EPBBPN3-A015Z	96911	20	250
2.5 TD	2.497	96	6	04.1994-07.2001	X25DT		EPBBPN3-A013Z	95023	30	245

SIGNUM (Z03)

2.2 i	2.198	114	4	05.2003-05.2008	Z22YH		EPBMPN3-V005Z	93871	20	100
2.8 V6 Turbo	2.792	169	6	07.2005-05.2008	Z28NEL		EPBBPT4-V010Z	91257	20	250
2.8 V6 Turbo	2.792	184	6	05.2007-10.2008	Z28NET		EPBMPN3-V010Z	93991	10	117,5











SINTRA (APV)

2.2 DTI	2.171	85	4	07.1997-04.1999	X22DTH		EPBBPN3-A015Z	96911	20	250
2.2 DTI	2.171	85	4	07.1997-04.1999	X22DTH		EPBMPN3-A028Z	93480	10	115
2.2 i 16 V	2.198	104	4	11.1996-04.1999	X22XE		EPBMPN3-A028Z	93480	10	115







VECTRA (B) (J96)

2.0 DI 16V	1.995	60	4	08.1995-10.2001	X20DTL		EPBBPN3-A015Z	96911	20	250
2.0 DTI 16V	1.995	74	4	08.1995-10.2001	X20DTH, X20DTH		EPBBPN3-A015Z	96911	20	250
2.0 DTI 16V	1.995	74	4	08.1995-10.2001	Y20DTH, Y20DTH		EPBBPN3-A012Z	91308	25	290
2.2 DTI 16V	2.172	92	4	08.1995-10.2001	Y22DTR		EPBBPN3-A012Z	91308	25	290
2.2 i 16V	2.198	108	4	08.1995-10.2001	Z22SE		EPBMPN3-V005Z	93871	20	100



VECTRA MK II (C) (Z02)

2.2 16V	2.198	108	4	01.2002-10.2008	Z22SE		EPBMPN3-V005Z	93871	20	100
2.2 direct	2.198	114	4	01.2002-10.2008	Z22YH		EPBMPN3-V005Z	93871	20	100
2.8 V6 Turbo	2.792	169	6	08.2005-05.2009	Z28NEL	 ; With Charger Intercooler	EPBBPT4-V010Z	91257	20	250
2.8 V6 Turbo	2.792	169	6	08.2005-05.2009	Z28NEL	 ; Position: Intake Manifold	EPBMPN3-V010Z	93991	10	117,5
2.8 V6 Turbo	2.792	184	6	02.2006-05.2009	Z28NET	 ; With Charger Intercooler	EPBBPT4-V010Z	91257	20	250
2.8 V6 Turbo	2.792	184	6	02.2006-05.2009	Z28NET	 ; Position: Intake Manifold	EPBMPN3-V010Z	93991	10	117,5
2.8 V6 Turbo	2.792	188	6	08.2006-05.2009	Z28NET	 ; With Charger Intercooler	EPBBPT4-V010Z	91257	20	250
2.8 V6 Turbo	2.792	188	6	08.2006-05.2009	Z28NET	 ; Position: Intake Manifold	EPBMPN3-V010Z	93991	10	117,5
2.8 V6 Turbo	2.792	206	6	10.2006-05.2009	Z28NET	 ; With Charger Intercooler	EPBBPT4-V010Z	91257	20	250
2.8 V6 Turbo	2.792	206	6	10.2006-05.2009	Z28NET	 ; Position: Intake Manifold	EPBMPN3-V010Z	93991	10	117,5

VIVARO A (X83)

1.9 DI	1.870	59	4	08.2001-07.2014	F9Q762		EPBBPN3-V008Z	90842	20	250
1.9 DTI	1.870	74	4	08.2001-12.2006	F9Q760		EPBBPN3-V008Z	90842	20	250
2.0 CDTI	1.995	66	4	01.2006-07.2014	M9R630	 ; Position: Suction Pipe	EPBBPN3-V016Z	92713	50	350
2.0 CDTI	1.995	84	4	08.2006-07.2014	M9R630	 ; Position: Suction Pipe	EPBBPN3-V016Z	92713	50	350
2.0 ECOTEC	1.998	86	4	08.2006-07.2014	F4R820		EPBMPN3-V005Z	93871	20	100
2.0 16V	1.998	88	4	08.2001-12.2006	F4R720		EPBMPN3-V005Z	93871	20	100

VX220 CONVERTIBLE (E01)

2.0 i Turbo	1.998	147	4	03.2001-07.2005	Z20LET		EPBMPN3-A028Z	93480	10	115
2.0 i Turbo	1.998	147	4	03.2001-07.2005	Z20LET		EPBBPT4-V010Z	91257	20	250
2.2 i	2.198	108	4	09.2000-07.2005	Z22SE		EPBMPN3-V005Z	93871	20	100

MAP



l kW
C
Y
I



Type-N°

Stock-N°

kPa from
kPa to

VAUXHALL

VX220 CONVERTIBLE (E01)

2.0 VXR	1.998	162	4	10.2003-07.2005	Z20LET		EPBMPN3-A028Z	93480	10	115
2.0 VXR	1.998	162	4	10.2003-07.2005	Z20LET		EPBBPT4-V010Z	91257	20	250

VXR8 SALOON (E)

6.0	5.967	304	8	02.2007-	LS2		EPBMPN3-V005Z	93871	20	100
6.2	6.162	317	8	04.2008-	LS3		EPBMPN3-V017Z	91253	10	120
6.2 LS3 V8	6.162	320	8	06.2010-	LS3		EPBMPN3-V017Z	91253	10	120

ZAFIRA A (T98)

1.6 CNG	1.598	71	4	09.2001-06.2005	Z16YNG		EPBMPN3-V005Z	93871	20	100
2.0 DI 16V	1.995	60	4	10.1999-08.2005	X20DTL		EPBBPN3-A015Z	96911	20	250
2.0 DTI 16V	1.995	74	4	04.1999-08.2005	Y20DTH	; Chass. <Y2999999	EPBBPN3-A015Z	96911	20	250
2.0 DTI 16V	1.995	74	4	04.1999-08.2005	Y20DTH	; Chass. >12000001; Chass. <22999999	EPBBPN3-A012Z	91308	25	290
2.0 GSI Turbo	1.998	141	4	09.2001-06.2005	Z20LET		EPBMPN3-A028Z	93480	10	115
2.0	1.998	147	4	06.2002-06.2005	Z20LET		EPBBPT4-V010Z	91257	20	250
2.2 16V	2.198	108	4	11.1998-08.2004	Z22SE		EPBMPN3-V005Z	93871	20	100

ZAFIRA MK II (B) (A05)

1.6	1.598	77	4	07.2005-11.2014	Z16XER, Z16XE1	; For vehicles without steering column gear shift	EPBMPN3-V005Z	93871	20	100
1.6	1.598	85	4	12.2007-11.2014	Z16XER, A16XER		EPBMPN3-V041Z	92257	10	121,7
1.7 CDTI	1.686	81	4	04.2009-11.2014	A17DTJ, Z17DTJ		EPBMBT4-A002Z	92144	30,8	
1.7 CDTI	1.686	92	4	01.2008-11.2014	A17DTR		EPBMBT4-A002Z	92144	30,8	369,2
1.8	1.796	88	4	04.2013-11.2014	A18XEL		EPBMPN3-V017Z	91253	10	120
1.8	1.796	103	4	04.2005-11.2014	Z18XER, A18XER		EPBMPN3-V041Z	92257	10	121,7
2.0	1.998	147	4	07.2005-11.2014	Z20LER		EPBMPN3-A028Z	93480	10	115
2.0	1.998	147	4	07.2005-11.2014	Z20LER		EPBBPT4-V010Z	91257	20	250
2.0	1.998	176	4	01.2006-11.2014	Z20LEH		EPBMPN3-A028Z	93480	10	115
2.0	1.998	176	4	01.2006-11.2014	Z20LEH		EPBBPT4-V010Z	91257	20	250
2.2	2.198	110	4	07.2005-11.2014	Z22YH		EPBMPN3-V005Z	93871	20	100

ZAFIRA MK III (P12)

1.4	1.364	88	4	10.2011-08.2018	A14NEL	;	EPBMPN3-V017Z	91253	10	120
1.4	1.364	88	4	10.2011-08.2018	A14NEL	;	EPBBPN3-V029Z	92983	20	270
1.4	1.364	103	4	10.2011-08.2018	A14NET, B14NET	;	EPBMPN3-V017Z	91253	10	120
1.4	1.364	103	4	10.2011-08.2018	A14NET, B14NET	;	EPBBPN3-V029Z	92983	20	270
1.8	1.796	85	4	10.2011-08.2018	A18XEL		EPBMPN3-V017Z	91253	10	120
1.8	1.796	103	4	10.2011-08.2018	A18XER		EPBMPN3-V017Z	91253	10	120

VOLVO

240 (P242, P244, P245)

2.3	2.315	83	4	08.1986-07.1987	B230F		EPBMPN3-A003Z	92477	15	102
2.3 i Cat	2.316	85	4	08.1986-07.1993	B230F		EPBMPN3-A003Z	92477	15	102



MAP



l kW
C
Y
I



Type-N°

Stock-N°

kPa from

kPa to

VOLVO

440 (445)

1.6	1.596	61	4	09.1988-12.1996	B16F		EPBMPN3-A003Z	92477	15	102
1.7	1.721	75	4	08.1989-12.1996	B18FP		EPBMPN3-A003Z	92477	15	102
1.7	1.721	78	4	09.1988-12.1996	B18EP		EPBMPN3-A003Z	92477	15	102
1.8	1.794	66	4	08.1991-12.1996	B18U		EPBMPN3-A003Z	92477	15	102
2.0	1.998	80	4	08.1993-07.1996	B20F		EPBMPN3-A003Z	92477	15	102
2.0	1.998	81	4	08.1992-07.1995	B20F		EPBMPN3-A003Z	92477	15	102

460 (464)

1.6	1.596	61	4	07.1992-07.1996	B16F		EPBMPN3-A003Z	92477	15	102
1.7	1.721	75	4	08.1989-07.1992	B18EP		EPBMPN3-A003Z	92477	15	102
1.7	1.721	80	4	08.1989-07.1992	B18E		EPBMPN3-A003Z	92477	15	102
1.8	1.794	66	4	08.1991-07.1996	B18U		EPBMPN3-A003Z	92477	15	102
2.0	1.998	80	4	08.1993-07.1996	B20F		EPBMPN3-A003Z	92477	15	102
2.0	1.998	81	4	08.1992-07.1995	B20F		EPBMPN3-A003Z	92477	15	102

480 (482)

1.7	1.721	70	4	08.1987-07.1989	B18F		EPBMPN3-A003Z	92477	15	102
1.7	1.721	75	4	08.1989-07.1996	B18EP		EPBMPN3-A003Z	92477	15	102
1.7	1.721	78	4	04.1986-07.1989	B18E		EPBMPN3-A003Z	92477	15	102
1.7	1.721	80	4	08.1986-07.1988	B18E		EPBMPN3-A003Z	92477	15	102
2.0	1.998	81	4	08.1992-09.1995	B20F		EPBMPN3-A003Z	92477	15	102

740 (744, 745)

2.0	1.986	82	4	08.1989-08.1992	B200F		EPBMPN3-A033Z	96422	20	200
2.0 16V	1.986	100	4	09.1987-08.1990	B204E		EPBMPN3-A033Z	96422	20	200
2.0 GLE	1.986	103	4	09.1987-08.1990	B204E		EPBMPN3-A033Z	96422	20	200
2.0	1.986	118	4	01.1986-08.1990	B200ET		EPBMPN3-A033Z	96422	20	200
2.0	1.986	120	4	01.1985-12.1985	B200ET		EPBMPN3-A033Z	96422	20	200
2.3	2.315	83	4	01.1988-	B230F		EPBMPN3-A033Z	96422	20	200
2.3	2.316	84	4	01.1988-	B230F		EPBMPN3-A033Z	96422	20	200
2.3	2.316	85	4	01.1988-	B230F		EPBMPN3-A033Z	96422	20	200
2.3	2.316	96	4	08.1984-12.1992	B230E(01.85-07.88), B230FB		EPBMPN3-A003Z	92477	15	102
2.3 Turbo	2.316	121	4	08.1989-07.1990	B230GT		EPBMPN3-A033Z	96422	20	200
2.3 Turbo	2.316	125	4	09.1989-08.1991	B230GT		EPBMPN3-A033Z	96422	20	200
2.3 Turbo	2.316	134	4	08.1985-12.1988	B230ET		EPBMPN3-A033Z	96422	20	200

760 (704, 764, 765)

2.3	2.316	130	4	08.1984-08.1987	B230ET		EPBMPN3-A033Z	96422	20	200
2.3 Turbo	2.316	134	4	08.1984-08.1990	B230ET		EPBMPN3-A033Z	96422	20	200

850 (854, 855)

2.0	1.984	93	5	08.1994-12.1996	B5202S		EPBMPN3-A003Z	92477	15	102
2.4	2.435	103	5	06.1991-07.1994	B5252		EPBMPN3-A003Z	92477	15	102



MAP



l kW
C
Y
I



Type-N°

Stock-N°

kPa from
kPa to

VOLVO

850 (854, 855)

2.4	2.435	106	5	08.1994-12.1996	B5252FS		EPBMPN3-A003Z	92477	15	102
2.4 GLE	2.435	142	5	09.1993-10.1997	B5254T		EPBMPN3-A040Z	94558	20	100
2.4 AWD	2.435	142	5	04.1996-12.1996	B5254T		EPBMPN3-A040Z	94558	20	100
2.5 TDI	2.461	103	5	08.1995-12.1996	D5252T		EPBBPN3-A013Z	95023	30	245

C30 (533)

1.6	1.596	74	4	10.2006-12.2012	B4164S3		EPBMPT4-A007Z	96755	10	120
1.6 D	1.560	80	4	10.2006-12.2012	D4164T		EPBBPN3-A001Z	94263	10	240
1.6 D2	1.560	84	4	10.2010-12.2012	D4162T		EPBMBT4-A003Z	93024	12,9	316,5
1.8	1.798	92	4	-07.2010	B4184S11		EPBMPT4-A017Z	96798	10	115
1.8 FlexFuel	1.798	92	4	-07.2010	B4184S8		EPBMPT4-A017Z	96798	10	115
2.0 D	1.997	100	4	10.2006-12.2012	D4204T		EPBBPN3-A001Z	94263	10	240
2.0	1.999	107	4	10.2006-12.2012	B4204S3		EPBMPT4-A017Z	96798	10	115
2.0 D3	1.984	110	5	10.2010-12.2012	D5204T5		EPBBPN4-A020Z	92413	50	350
2.0 D4	1.984	130	5	10.2010-12.2012	D5204T		EPBBPN4-A020Z	92413	50	350
2.4 D5	2.400	120	5	10.2006-12.2012	D5244T9		EPBBPT4-V009Z	95675	20	300
2.4 i	2.435	125	5	10.2006-12.2012	B5244S4		EPBMPN3-A039Z	97513	15	135
2.4 D5	2.400	132	5	10.2006-12.2012	D5244T13, D5244T8		EPBBPT4-V009Z	95675	20	300
2.5 T5	2.521	162	5	10.2006-12.2012	B5254T3	; Chass. <38999	EPBBPT4-V013Z	91803	20	250
2.5 T5	2.521	169	5	03.2007-12.2012	B5254T7	; Chass. <38999	EPBBPT4-V013Z	91803	20	250
2.5 T5	2.521	169	5	03.2007-12.2012	B5254T7		EPBBPT4-V009Z	95675	20	300

C70 I (872, 873)

2.0 T	1.984	120	5	03.2000-10.2005	B5204T4	; With Charger Intercooler	EPBBPN3-V034Z	96381	20	250
2.0 T	1.984	120	5	03.2000-10.2005	B5204T4	; Position: Intake Manifold	EPBMPN3-A040Z	94558	20	100
2.0	1.984	132	5	03.1997-10.2005	B5204T2		EPBMPN3-A040Z	94558	20	100
2.0 T	1.984	166	5	03.1997-10.2005	B5204T3	; With Charger Intercooler	EPBBPN3-V034Z	96381	20	250
2.0 T	1.984	166	5	03.1997-10.2005	B5204T3	; Position: Intake Manifold	EPBMPN3-A040Z	94558	20	100
2.3 T5	2.319	176	5	03.1997-10.2005	B5234T3	; With Charger Intercooler	EPBBPN3-V034Z	96381	20	250
2.3 T5	2.319	176	5	03.1997-10.2005	B5234T3	; Position: Intake Manifold	EPBMPN3-A040Z	94558	20	100
2.3 T5	2.319	180	5	07.2002-10.2005	B5234T9	; With Charger Intercooler	EPBBPN3-V034Z	96381	20	250
2.3 T5	2.319	180	5	07.2002-10.2005	B5234T9	; Position: Intake Manifold	EPBMPN3-A040Z	94558	20	100
2.4	2.435	121	5	03.1999-09.2002	B5254S		EPBMPN3-A023Z	96241	10	130
2.4	2.435	125	5	06.1998-10.2005	B5244S, B5254S		EPBMPN3-A023Z	96241	10	130
2.4 T	2.435	142	5	03.1997-10.2005	B5254T, B5244T	; Position: Intake Manifold	EPBMPN3-A040Z	94558	20	100
2.4 T	2.435	142	5	03.1997-10.2005	B5254T, B5244T	; With Charger Intercooler	EPBBPN3-V034Z	96381	20	250
2.4 T	2.435	147	5	07.2002-10.2005	B5244T7	; With Charger Intercooler	EPBBPN3-V034Z	96381	20	250
2.4 T	2.435	147	5	07.2002-10.2005	B5244T7	; Position: Intake Manifold	EPBMPN3-A040Z	94558	20	100



MAP



l kW
C
Y
I



Type-N°

Stock-N°

kPa from

kPa to

VOLVO

C70 II CONVERTIBLE (542)

2.0 D	1.997	100	4	01.2008-10.2009	D4204T		EPBBPN3-A001Z	94263	10	240
2.0 D3	1.984	110	5	10.2010-06.2013	D5204T5		EPBBPN4-A020Z	92413	50	350
2.0 D4	1.984	130	5	10.2010-06.2013	D5204T		EPBBPN4-A020Z	92413	50	350
2.4	2.435	103	5	03.2006-10.2009	B5244S5		EPBMPN3-A039Z	97513	15	135
2.4 D	2.400	120	5	03.2007-06.2013	D5244T9		EPBBPT4-V009Z	95675	20	300
2.4 i	2.435	125	5	03.2006-10.2009	B5244S4		EPBMPN3-A039Z	97513	15	135
2.4 D5	2.400	132	5	03.2006-06.2013	D5244T13, D5244T8		EPBBPT4-V009Z	95675	20	300
2.5 T5	2.521	162	5	03.2006-02.2007	B5254T3	; Chass. <40042; With Charger Intercooler	EPBBPT4-V013Z	91803	20	250
2.5 T5	2.521	169	5	03.2007-10.2009	B5254T7	; Chass. <40042; With Charger Intercooler	EPBBPT4-V013Z	91803	20	250
2.5 T5	2.521	169	5	03.2007-10.2009	B5254T7		EPBBPT4-V009Z	95675	20	300

S40 I (644)

1.6	1.588	77	4	09.1995-08.1999	B4164S		EPBMPN3-A003Z	92477	15	102
1.6	1.587	80	4	03.1999-12.2003	B4164S2		EPBMPN3-A003Z	92477	15	102
1.8	1.731	85	4	07.1995-08.1999	B4184S, B4184S3		EPBMPN3-A003Z	92477	15	102
1.8	1.783	90	4	03.1999-12.2003	B4184S2		EPBMPN3-A003Z	92477	15	102
1.9 DI	1.870	75	4	07.2000-12.2003	D4192T4	; OE 30889795	EPBMPN3-V013Z	94788	15	255
1.9 DI	1.870	85	4	07.2000-12.2003	D4192T3	; OE 30889795	EPBMPN3-V013Z	94788	15	255
1.9 T4	1.855	147	4	05.1997-07.2000	B4194T, B4194T2	; Position: Intake Manifold	EPBMPN3-A040Z	94558	20	100
1.9 T4	1.855	147	4	05.1997-07.2000	B4194T, B4194T2	; With Charger Intercooler	EPBBPN3-V034Z	96381	20	250
2.0	1.948	100	4	07.1995-12.2003	B4204S, B4204S2		EPBMPN3-A003Z	92477	15	102
2.0	1.948	103	4	07.1995-08.1999	B4204S		EPBMPN3-A003Z	92477	15	102
2.0 T	1.948	118	4	10.1997-12.2003	B4204T	; With Charger Intercooler	EPBBPN3-V034Z	96381	20	250
2.0 T	1.948	118	4	10.1997-12.2003	B4204T	; Position: Intake Manifold	EPBMPN3-A040Z	94558	20	100
2.0 T	1.948	120	4	06.2001-12.2003	B4204T3	; With Charger Intercooler	EPBBPN3-V034Z	96381	20	250
2.0 T	1.948	120	4	06.2001-12.2003	B4204T3	; Position: Intake Manifold	EPBMPN3-A040Z	94558	20	100
2.0 T4	1.948	147	4	07.2000-12.2003	B4204T5	; With Charger Intercooler	EPBBPN3-V034Z	96381	20	250
2.0 T4	1.948	147	4	07.2000-12.2003	B4204T5	; Position: Intake Manifold	EPBMPN3-A040Z	94558	20	100

S40 II (544)

1.6	1.596	74	4	01.2005-12.2012	B4164S3		EPBMPT4-A007Z	96755	10	120
1.6 D	1.560	81	4	01.2005-12.2012	D4164T		EPBBPN3-A001Z	94263	10	240
1.6 D2	1.560	84	4	10.2010-12.2012	D4162T		EPBMBT4-A003Z	93024	12,9	316,5
1.8 FlexFuel	1.798	92	4	01.2006-12.2010	B4184S8		EPBMPT4-A017Z	96798	10	115
1.8	1.798	92	4	04.2004-12.2010	B4184S11		EPBMPT4-A017Z	96798	10	115
2.0 D	1.997	100	4	01.2004-12.2010	D4204T		EPBBPN3-A001Z	94263	10	240
2.0 F	1.999	107	4	-08.2012	B4204S4		EPBMPT4-A017Z	96798	10	115
2.0	1.999	107	4	10.2006-12.2012	B4204S3		EPBMPT4-A017Z	96798	10	115



MAP

 ℓ kW
C
Y
I

Type-N°

Stock-N°

 kPa from
kPa to

VOLVO
S40 II (544)

2.0 D3	1.984	110	5	10.2010-12.2012	D5204T5		EPBBPN4-A020Z	92413	50	350
2.0 D4	1.984	130	5	10.2010-12.2012	D5204T		EPBBPN4-A020Z	92413	50	350
2.4	2.435	103	5	01.2004-12.2010	B5244S5		EPBMPN3-A039Z	97513	15	135
2.4	2.435	125	5	01.2004-12.2012	B5244S4		EPBMPN3-A039Z	97513	15	135
2.4 D5	2.400	132	5	03.2006-12.2010	D5244T13, D5244T8		EPBBPT4-V009Z	95675	20	300
2.5 T5 AWD	2.521	169	5	03.2007-12.2010	B5254T7		EPBBPT4-V009Z	95675	20	300
2.5 T5	2.521	169	5	03.2007-12.2012	B5254T7		EPBBPT4-V009Z	95675	20	300

S60 I (384)

2.0 T	1.984	132	5	-01.2002	B5204T5	; With Charger Intercooler	EPBBPN3-V034Z	96381	20	250
2.0 T	1.984	132	5	01.2003-	B5204T5	; With Charger Intercooler	EPBBPT4-V013Z	91803	20	250
2.3 T5	2.319	184	5	-01.2002	B5234T3	; With Charger Intercooler	EPBBPN3-V034Z	96381	20	250
2.3 T5	2.319	184	5	01.2003-	B5234T3	; With Charger Intercooler	EPBBPT4-V013Z	91803	20	250
2.4 CDI	2.401	85	5	10.2003-12.2005	D5244T3	; With Charger Intercooler	EPBBPT4-V013Z	91803	20	250
2.4 D	2.400	93	5	03.2005-04.2010	D5244T7		EPBBPT4-V009Z	95675	20	300
2.4	2.435	103	5	07.2000-04.2010	B5244S2		EPBMPN3-A014Z	90281	10	130
2.4	2.435	103	5	07.2000-04.2010	B5244S2		EPBBPT4-V018Z	91887	50	600
2.4 Bifuel CNG	2.435	103	5	07.2001-04.2010	B5244SG		EPBMPN3-A037Z	94170	10	130
2.4 Bifuel CNG	2.435	103	5	07.2001-04.2010	B5244SG		EPBBPT4-V018Z	91887	50	600
2.4 Bifuel LPG	2.435	103	5	07.2001-04.2010	B5244SG2		EPBMPN3-A037Z	94170	10	130
2.4 Bifuel LPG	2.435	103	5	07.2001-04.2010	B5244SG2		EPBBPT4-V018Z	91887	50	600
2.4 D	2.400	120	5	07.2005-12.2009	D5244T5		EPBBPT4-V009Z	95675	20	300
2.4 D5	2.401	120	5	01.2001-04.2010	D5244T	; With Charger Intercooler	EPBBPT4-V013Z	91803	20	250
2.4	2.435	125	5	11.2000-04.2010	B5244S		EPBMPN3-A014Z	90281	10	130
2.4	2.435	125	5	11.2000-04.2010	B5244S		EPBBPT4-V018Z	91887	50	600
2.4 D5	2.401	136	5	03.2005-04.2010	D5244T4		EPBBPT4-V009Z	95675	20	300
2.4 T	2.435	147	5	-01.2002	B5244T3	; With Charger Intercooler	EPBBPN3-V034Z	96381	20	250
2.4 T AWD	2.435	147	5	-01.2002	B5244T3	; With Charger Intercooler	EPBBPN3-V034Z	96381	20	250
2.4 T	2.435	147	5	01.2003-	B5244T3	; With Charger Intercooler	EPBBPT4-V013Z	91803	20	250
2.4 T AWD	2.435	147	5	01.2003-	B5244T3	; With Charger Intercooler	EPBBPT4-V013Z	91803	20	250
2.4 T5	2.401	191	5	04.2004-04.2010	B5244T5		EPBBPT4-V009Z	95675	20	300
2.5 T	2.521	154	5	01.2003-04.2010	B5254T2	; With Charger Intercooler	EPBBPT4-V013Z	91803	20	250
2.5 T AWD	2.521	154	5	07.2002-04.2010	B5254T2	; With Charger Intercooler	EPBBPT4-V013Z	91803	20	250
2.5 T AWD R	2.521	221	5	01.2003-04.2010	B5254T4		EPBBPT4-V009Z	95675	20	300

S60 II (134)

1.6 DRIVE / D2	1.560	84	4	01.2011-12.2015	D4162T		EPBMBT4-A003Z	93024	12,9	316,5
1.6 T3	1.596	110	4	04.2010-12.2015	B4164T3		EPBMPN3-V019Z	93061	10	307,5
1.6 T3	1.596	110	4	04.2010-12.2015	B4164T3		EPBBPT4-V001Z	92565	11	307



MAP



l kW
C
Y
I



Type-N°

Stock-N°

kPa from

kPa to

VOLVO

S60 II (134)

1.6 T4	1.596	132	4	04.2010-12.2015	B4164T		EPBMPN3-V019Z	93061	10	307,5
1.6 T4	1.596	132	4	04.2010-12.2015	B4164T		EPBBPT4-V001Z	92565	11	307
1.6 T4F	1.596	132	4	04.2011-12.2015	B4164T2		EPBMPN3-V019Z	93061	10	307,5
1.6 T4F	1.596	132	4	04.2011-12.2015	B4164T2		EPBBPT4-V001Z	92565	11	307
2.0 D3	1.984	100	5	05.2012-12.2015	D5204T7		EPBBPN4-A020Z	92413	50	350
2.0 D3	1.984	120	5	04.2010-12.2014	D5204T2, D5204T3		EPBBPN4-A020Z	92413	50	350
2.0 D4	1.984	120	5	04.2010-12.2014	D5204T3		EPBBPN4-A020Z	92413	50	350
2.0 T	1.999	149	4	04.2010-12.2011	B4204T6	; Position: Intake Manifold	EPBMPN3-V019Z	93061	10	307,5
2.0 T	1.999	149	4	04.2010-12.2011	B4204T6		EPBBPT4-V009Z	95675	20	300
2.0 T5	1.999	177	4	04.2010-12.2014	B4204T7		EPBMPN3-V019Z	93061	10	307,5
2.0 T5	1.999	177	4	04.2010-12.2014	B4204T7		EPBBPT4-V009Z	95675	20	300
2.4 D4 AWD	2.400	140	5	03.2015-	D5244T21		EPBBPN4-A020Z	92413	50	350
2.4 D5	2.400	151	5	04.2010-12.2011	D5244T10		EPBBPN4-A020Z	92413	50	350
2.4 D5 AWD	2.400	151	5	04.2010-12.2011	D5244T10		EPBBPN4-A020Z	92413	50	350
2.4 D5	2.400	158	5	04.2011-12.2015	D5244T11, D5244T15		EPBBPN4-A020Z	92413	50	350
2.4 D5 AWD	2.400	158	5	04.2011-12.2015	D5244T15		EPBBPN4-A020Z	92413	50	350
2.4 D5	2.400	169	5	-07.2015	D5244T23		EPBBPN4-A020Z	92413	50	350
2.4 D5 AWD	2.400	169	5	-07.2015	D5244T23		EPBBPN4-A020Z	92413	50	350
3.0 T6 AWD	2.953	224	6	04.2010-12.2015	B6304T4		EPBBPT4-V009Z	95675	20	300

S70 (874)

2.0	1.984	93	5	01.1997-11.2000	B5202FS, B5202S		EPBMPN3-A003Z	92477	15	102
2.0	1.984	120	5	01.1997-11.2000	B5204T4	; With Charger Intercooler	EPBBPN3-V034Z	96381	20	250
2.0	1.984	120	5	01.1997-11.2000	B5204T4		EPBMPN3-A040Z	94558	20	100
2.0	1.984	132	5	01.1997-11.2000	B5204T2		EPBMPN3-A040Z	94558	20	100
2.0 Turbo	1.984	166	5	01.1997-11.2000	B5204T3		EPBMPN3-A040Z	94558	20	100
2.0 Turbo	1.984	166	5	01.1999-	B5204T3	; With Charger Intercooler	EPBBPN3-V034Z	96381	20	250
2.3 T-5	2.319	176	5	01.1997-11.2000	B5234T3		EPBMPN3-A040Z	94558	20	100
2.3 T-5	2.319	176	5	01.1999-	B5234T3	; With Charger Intercooler	EPBBPN3-V034Z	96381	20	250
2.3 Turbo	2.319	184	5	01.1997-11.2000	B5234FT+		EPBMPN3-A040Z	94558	20	100
2.3	2.319	195	5	01.1999-	B5234T7	; With Charger Intercooler	EPBBPN3-V034Z	96381	20	250
2.3	2.319	195	5	04.1999-09.2000	B5234T7		EPBMPN3-A040Z	94558	20	100
2.4 AWD	2.435	103	5	04.1999-09.2000	B5244S2		EPBMPN3-A023Z	96241	10	130
2.4 Bifuel	2.435	103	5	07.1999-11.2000	B5244SG		EPBMPN3-A023Z	96241	10	130
2.4	2.435	103	5	08.1999-11.2000	B5244S2, B5244SG		EPBMPN3-A023Z	96241	10	130
2.4 Blu-Fuel	2.435	103	5	07.1997-09.2000	B5244S2, B5244SG		EPBMPN3-A023Z	96241	10	130
2.4	2.435	106	5	01.1997-11.2000	B5252FS		EPBMPN3-A003Z	92477	15	102
2.4 Bifuel	2.435	106	5	10.1998-11.2000	GB5252S		EPBMPN3-A003Z	92477	15	102



MAP

 l kW
C
Y
I

Type-N°

Stock-N°

 kPa from
kPa to

VOLVO
S70 (874)

2.4 AWD	2.435	106	5	11.1996-05.1999	B5252FS		EPBMPN3-A003Z	92477	15	102
2.4	2.435	121	5	01.1999-	B5254S		EPBMPN3-A023Z	96241	10	130
2.4	2.435	125	5	01.1997-11.2000	B5244S		EPBMPN3-A023Z	96241	10	130
2.4 AWD	2.435	125	5	04.1999-09.2000	B5244S		EPBMPN3-A023Z	96241	10	130
2.4 Turbo	2.435	142	5	01.1997-11.2000	B5244T	; With Charger Intercooler	EPBBPN3-V034Z	96381	20	250
2.4 Turbo	2.435	142	5	01.1999-	B5254T	; With Charger Intercooler	EPBBPN3-V034Z	96381	20	250
2.4 T5 AWD	2.435	142	5	01.1999-	B5254T	; With Charger Intercooler	EPBBPN3-V034Z	96381	20	250
2.4 T5 AWD	2.435	142	5	11.1996-04.1999	B5254T		EPBMPN3-A040Z	94558	20	100
2.4 Turbo	2.435	142	5	01.1997-11.2000	B5254T, B5244T		EPBMPN3-A040Z	94558	20	100
2.5 TDi AWD	2.460	103	5	10.1999-09.2000	D5252T		EPBBPN3-A013Z	95023	30	245
2.5 TDi	2.461	103	5	01.1997-11.2000	D5252T		EPBBPN3-A013Z	95023	30	245

S80 I (184)

2.0	1.984	120	5	06.1998-07.2006	B5204T4	; With Charger Intercooler	EPBBPN3-V034Z	96381	20	250
2.0 T	1.984	132	5	-01.2002	B5204T5	; With Charger Intercooler	EPBBPN3-V034Z	96381	20	250
2.0 T	1.984	132	5	01.2003-	B5204T5	; With Charger Intercooler	EPBBPT4-V013Z	91803	20	250
2.0 T	1.984	166	5	06.1998-07.2006	B5204T3	; With Charger Intercooler	EPBBPN3-V034Z	96381	20	250
2.4	2.435	103	5	01.1999-07.2006	B5244S2		EPBMPN3-A037Z	94170	10	130
2.4 Bifuel CNG	2.435	103	5	09.2001-07.2006	B5244SG2		EPBMPN3-A037Z	94170	10	130
2.4 Bifuel LPG	2.435	103	5	09.2001-07.2006	B5244SG		EPBMPN3-A037Z	94170	10	130
2.4	2.435	125	5	01.1999-07.2006	B5244S		EPBMPN3-A037Z	94170	10	130
2.4 T	2.435	147	5	-01.2002	B5244T3	; With Charger Intercooler	EPBBPN3-V034Z	96381	20	250
2.4 T5 AWD	2.435	147	5	-01.2002	B5244T3	; With Charger Intercooler	EPBBPN3-V034Z	96381	20	250
2.4 T	2.435	147	5	01.2003-	B5244T3	; With Charger Intercooler	EPBBPT4-V013Z	91803	20	250
2.4 T5 AWD	2.435	147	5	01.2003-	B5244T3	; With Charger Intercooler	EPBBPT4-V013Z	91803	20	250
2.5 TDi	2.461	103	5	01.1999-07.2006	D5252T		EPBBPN3-A013Z	95023	30	245
2.5 T	2.521	154	5	03.2003-07.2006	B5254T2	; With Charger Intercooler	EPBBPT4-V013Z	91803	20	250
2.5 T AWD	2.521	154	5	07.2003-07.2006	B5254T2		EPBBPT4-V013Z	91803	20	250
2.8 T6	2.783	200	6	05.1998-07.2006	B6284T		EPBBPN3-V034Z	96381	20	250
3.0 T6	2.922	200	6	-01.2002	B6294T		EPBBPN3-V034Z	96381	20	250
3.0 T6	2.922	200	6	01.2003-	B6294T		EPBBPT4-V013Z	91803	20	250

S80 II (124)

1.6 D DRiVe	1.560	80	4	01.2010-12.2011	D4164T		EPBBPN3-A001Z	94263	10	240
1.6 DRiVe	1.560	84	4	06.2011-	D4162T		EPBMBT4-A003Z	93024	12,9	316,5
1.6 T4	1.596	132	4	10.2010-	B4164T		EPBMPN3-V019Z	93061	10	307,5
1.6 T4	1.596	132	4	10.2010-	B4164T		EPBBPT4-V001Z	92565	11	307
1.6 T4F	1.596	132	4	05.2011-	B4164T2		EPBMPN3-V019Z	93061	10	307,5
1.6 T4F	1.596	132	4	05.2011-	B4164T2		EPBBPT4-V001Z	92565	11	307



MAP



l kW
C
Y
I



Type-N°

Stock-N°

kPa from

kPa to

VOLVO

S80 II (124)

2.0 TDi	1.997	100	4	02.2008-03.2011	D4204T		EPBBPN3-A001Z	94263	10	240
2.0	1.999	107	4	-07.2012	B4204S3		EPBMPT4-A017Z	96798	10	115
2.0 FlexFuel	1.999	107	4	01.2008-12.2011	B4204S4		EPBMPT4-A017Z	96798	10	115
2.0 D3	1.984	120	5	01.2010-	D5204T2, D5204T3		EPBBPT4-V009Z	95675	20	300
2.0 D3	1.984	120	5	01.2010-	D5204T2, D5204T3		EPBBPN4-A020Z	92413	50	350
2.0 T	1.999	149	4	01.2010-	B4204T6		EPBMPN3-V019Z	93061	10	307,5
2.0 T	1.999	149	4	01.2010-	B4204T6		EPBBPT4-V009Z	95675	20	300
2.0 T5	1.999	177	4	10.2010-12.2016	B4204T7		EPBMPN3-V019Z	93061	10	307,5
2.0 T5	1.999	177	4	10.2010-12.2016	B4204T7		EPBBPT4-V009Z	95675	20	300
2.4 D	2.400	120	5	03.2006-	D5244T19, D5244T5		EPBBPT4-V009Z	95675	20	300
2.4 D	2.400	120	5	03.2006-	D5244T19, D5244T5		EPBBPN4-A020Z	92413	50	350
2.4 D	2.400	129	5	01.2010-03.2011	D5244T14		EPBBPT4-V009Z	95675	20	300
2.4 D	2.400	129	5	01.2010-03.2011	D5244T14		EPBBPN4-A020Z	92413	50	350
2.4 D5 AWD	2.400	136	5	01.2007-	D5244T4		EPBBPT4-V009Z	95675	20	300
2.4 D5	2.400	136	5	03.2006-	D5244T4		EPBBPT4-V009Z	95675	20	300
2.4 D5	2.400	151	5	01.2010-	D5244T10		EPBBPN4-A020Z	92413	50	350
2.4 D5 AWD	2.400	151	5	01.2010-	D5244T10		EPBBPN4-A020Z	92413	50	350
2.4 D5 AWD	2.400	158	5	06.2011-	D5244T15		EPBBPN4-A020Z	92413	50	350
2.4 D5	2.400	158	5	06.2011-	D5244T11, D5244T15		EPBBPN4-A020Z	92413	50	350
2.5 T	2.521	147	5	03.2006-12.2011	B5254T6		EPBBPT4-V009Z	95675	20	300
2.5 T FlexFuel	2.521	147	5	05.2008-12.2011	B5254T8		EPBBPT4-V009Z	95675	20	300
2.5 T FlexFuel	2.521	170	5	01.2010-12.2011	B5254T11		EPBBPT4-V009Z	95675	20	300
2.5 T	2.521	170	5	01.2010-12.2012	B5254T10		EPBBPT4-V009Z	95675	20	300
3.0 T6 AWD	2.953	210	6	01.2007-12.2010	B6304T2		EPBBPT4-V009Z	95675	20	300
3.0 T6 AWD	2.953	224	6	10.2010-12.2016	B6304T4		EPBBPT4-V009Z	95675	20	300

V40 ESTATE (645)

1.6	1.588	77	4	12.1995-08.1999	B4164S		EPBMPN3-A003Z	92477	15	102
1.6	1.587	80	4	03.1999-06.2004	B4164S2		EPBMPN3-A003Z	92477	15	102
1.8	1.731	85	4	07.1995-08.1999	B4184S, B4184S3		EPBMPN3-A003Z	92477	15	102
1.8	1.783	90	4	03.1999-06.2004	B4184S2		EPBMPN3-A003Z	92477	15	102
1.9 DI	1.870	75	4	07.2000-06.2004	D4192T4	; OE 30889795	EPBMPN3-V013Z	94788	15	255
1.9 DI	1.870	85	4	07.2000-06.2004	D4192T3	; OE 30889795	EPBMPN3-V013Z	94788	15	255
1.9 T4	1.855	147	4	05.1997-07.2000	B4194T	; With Charger Intercooler	EPBBPN3-V034Z	96381	20	250
1.9 T4	1.855	147	4	05.1997-07.2000	B4194T	; Position: Intake Manifold	EPBMPN3-A040Z	94558	20	100
2.0	1.948	100	4	07.1995-06.2004	B4204S, B4204S2		EPBMPN3-A003Z	92477	15	102
2.0	1.948	103	4	07.1995-08.1999	B4204S		EPBMPN3-A003Z	92477	15	102
2.0 T	1.948	118	4	10.1997-07.2000	B4204T	; With Charger Intercooler	EPBBPN3-V034Z	96381	20	250



MAP

 ℓ kW
C
Y
I

Type-N°

Stock-N°

 kPa from
kPa to

VOLVO
V40 ESTATE (645)

2.0 T	1.948	118	4	10.1997-07.2000	B4204T	; Position: Intake Manifold	EPBMPN3-A040Z	94558	20	100
2.0 T	1.948	120	4	06.2001-06.2004	B4204T3	; With Charger Intercooler	EPBBPN3-V034Z	96381	20	250
2.0 T	1.948	120	4	06.2001-06.2004	B4204T3	; Position: Intake Manifold	EPBMPN3-A040Z	94558	20	100
2.0 T	1.948	121	4	07.1999-06.2004	B4204T2	; With Charger Intercooler	EPBBPN3-V034Z	96381	20	250
2.0 T	1.948	121	4	07.1999-06.2004	B4204T2	; Position: Intake Manifold	EPBMPN3-A040Z	94558	20	100
2.0 T4	1.948	147	4	07.2000-06.2004	B4204T5	; With Charger Intercooler	EPBBPN3-V034Z	96381	20	250
2.0 T4	1.948	147	4	07.2000-06.2004	B4204T5	; Position: Intake Manifold	EPBMPN3-A040Z	94558	20	100

V40 HATCHBACK (525, 526)

1.6 D2	1.560	84	4	03.2012-	D4162T	; Position: Intake Manifold	EPBMBT4-A003Z	93024	12,9	316,5
1.6 T2	1.596	88	4	03.2013-12.2015	B4164T4		EPBMPN3-V019Z	93061	10	307,5
1.6 T3	1.596	110	4	03.2012-	B4164T3		EPBMPN3-V019Z	93061	10	307,5
1.6 T4	1.596	132	4	03.2012-	B4164T		EPBMPN3-V019Z	93061	10	307,5
1.6 T4	1.596	147	4	04.2014-	B4164T		EPBMPN3-V019Z	93061	10	307,5
2.0 D3	1.984	110	5	03.2012-03.2015	D5204T6		EPBBPN4-A020Z	92413	50	350
2.0 D4	1.984	130	5	03.2012-	D5204T4		EPBBPN4-A020Z	92413	50	350

V50 (545)

1.6	1.596	74	4	01.2005-12.2012	B4164S3		EPBMPT4-A007Z	96755	10	120
1.6 D	1.560	81	4	01.2005-12.2011	D4164T		EPBBPN3-A001Z	94263	10	240
1.6 D2	1.560	84	4	01.2010-12.2012	D4162T		EPBMBT4-A003Z	93024	12,9	316,5
1.8	1.798	92	4	04.2004-12.2010	B4184S11		EPBMPT4-A017Z	96798	10	115
1.8 FlexFuel	1.798	92	4	01.2005-12.2010	B4184S8		EPBMPT4-A017Z	96798	10	115
2.0 D	1.997	100	4	04.2004-12.2010	D4204T		EPBBPN3-A001Z	94263	10	240
2.0 FlexFuel	1.999	107	4	01.2010-12.2012	B4204S4		EPBMPT4-A017Z	96798	10	115
2.0	1.999	107	4	10.2006-12.2012	B4204S3		EPBMPT4-A017Z	96798	10	115
2.0 D3	1.984	110	5	10.2010-12.2012	D5204T5		EPBBPN4-A020Z	92413	50	350
2.0 D4	1.984	130	5	10.2010-12.2012	D5204T		EPBBPN4-A020Z	92413	50	350
2.4	2.435	103	5	04.2004-12.2010	B5244S5		EPBMPN3-A039Z	97513	15	135
2.4 Tdi	2.400	120	5	05.2007-12.2010	D5244T9		EPBBPT4-V009Z	95675	20	300
2.4	2.435	125	5	04.2004-12.2010	B5244S4		EPBMPN3-A039Z	97513	15	135
2.4 AWD	2.435	125	5	08.2006-12.2009	B5244S4		EPBMPN3-A039Z	97513	15	135
2.4 D5	2.400	132	5	03.2006-12.2010	D5244T13, D5244T8		EPBBPT4-V009Z	95675	20	300
2.5 T5 AWD	2.521	169	5	03.2007-12.2010	B5254T7		EPBBPT4-V009Z	95675	20	300
2.5 T5	2.521	169	5	03.2007-12.2012	B5254T7		EPBBPT4-V009Z	95675	20	300

V60 I (155, 157)

1.6 DRiVe	1.560	84	4	02.2011-12.2015	D4162T	; Position: Intake Manifold	EPBMBT4-A003Z	93024	12,9	316,5
1.6 T3	1.596	110	4	09.2010-12.2015	B4164T3		EPBMPN3-V019Z	93061	10	307,5
1.6 T3	1.596	110	4	09.2010-12.2015	B4164T3		EPBBPT4-V001Z	92565	11	307



MAP



kW
C
Y
I



Type-N°

Stock-N°

kPa from

kPa to

VOLVO

V60 I (155, 157)

1.6 T4	1.596	132	4	09.2010-12.2015	B4164T		EPBMPN3-V019Z	93061	10	307,5
1.6 T4	1.596	132	4	09.2010-12.2015	B4164T		EPBBPT4-V001Z	92565	11	307
1.6 T4F	1.596	132	4	04.2011-12.2015	B4164T2		EPBMPN3-V019Z	93061	10	307,5
1.6 T4F	1.596	132	4	04.2011-12.2015	B4164T2		EPBBPT4-V001Z	92565	11	307
2.0 D3	1.984	100	5	05.2012-12.2015	D5204T7		EPBBPN4-A020Z	92413	50	350
2.0 D3	1.984	120	5	07.2010-12.2014	D5204T2, D5204T3		EPBBPN4-A020Z	92413	50	350
2.0 T	1.999	149	4	07.2010-12.2012	B4204T6		EPBMPN3-V019Z	93061	10	307,5
2.0 T	1.999	149	4	07.2010-12.2012	B4204T6		EPBBPT4-V009Z	95675	20	300
2.0 T5	1.999	176	4	08.2012-	B4204T7	; Position: Intake Manifold	EPBMPN3-V019Z	93061	10	307,5
2.0 T5	1.999	177	4	09.2010-12.2014	B4204T7		EPBMPN3-V019Z	93061	10	307,5
2.0 T5	1.999	177	4	09.2010-12.2014	B4204T7		EPBBPT4-V009Z	95675	20	300
2.4 D4 AWD	2.400	120	5	05.2012-	D5244T17		EPBBPN4-A020Z	92413	50	350
2.4 D4 AWD	2.400	133	5	-08.2015	D5244T12		EPBBPN4-A020Z	92413	50	350
2.4 D5	2.400	151	5	07.2010-12.2011	D5244T10		EPBBPN4-A020Z	92413	50	350
2.4 D5 AWD	2.400	151	5	07.2010-12.2011	D5244T10		EPBBPN4-A020Z	92413	50	350
2.4 D5	2.400	158	5	04.2011-12.2015	D5244T11, D5244T15		EPBBPN4-A020Z	92413	50	350
2.4 D5 AWD	2.400	158	5	04.2011-12.2015	D5244T15		EPBBPN4-A020Z	92413	50	350
2.4 Hybrid D6 AWD	2.400	158	5	06.2012-12.2015	D82PHEV		EPBBPN4-A020Z	92413	50	350
2.4 D5	2.400	169	5	-08.2015	D5244T23		EPBBPN4-A020Z	92413	50	350
2.4 D5 AWD	2.400	169	5	-08.2015	D5244T23		EPBBPN4-A020Z	92413	50	350
3.0 T6 AWD	2.953	224	6	07.2010-12.2015	B6304T4		EPBBPT4-V009Z	95675	20	300

V70 I (875, 876)

2.0	1.984	93	5	12.1995-03.2000	B5202FS, B5202S		EPBMPN3-A003Z	92477	15	102
2.0	1.984	120	5	01.1997-12.2000	B5204T4	; With Charger Intercooler	EPBBPN3-V034Z	96381	20	250
2.0	1.984	120	5	01.1997-12.2000	B5204T4		EPBMPN3-A040Z	94558	20	100
2.0	1.984	132	5	11.1996-03.2000	B5204T2		EPBMPN3-A040Z	94558	20	100
2.0 Turbo	1.984	166	5	01.1999-	B5204T3	; With Charger Intercooler	EPBBPN3-V034Z	96381	20	250
2.0 Turbo AWD	1.984	166	5	01.1999-	B5204T3	; With Charger Intercooler	EPBBPN3-V034Z	96381	20	250
2.0 Turbo	1.984	166	5	11.1996-12.2000	B5204T3		EPBMPN3-A040Z	94558	20	100
2.0 Turbo AWD	1.984	166	5	11.1996-12.2000	B5204T3		EPBMPN3-A040Z	94558	20	100
2.3 T-5 AWD	2.319	176	5	01.1997-12.2000	B5234T3		EPBMPN3-A040Z	94558	20	100
2.3 T-5	2.319	176	5	01.1999-	B5234T3	; With Charger Intercooler	EPBBPN3-V034Z	96381	20	250
2.3 T-5 AWD	2.319	176	5	01.1999-	B5234T3	; With Charger Intercooler	EPBBPN3-V034Z	96381	20	250
2.3 T-5	2.319	176	5	11.1996-12.2000	B5234T3		EPBMPN3-A040Z	94558	20	100
2.3 AWD	2.319	177	5	01.1999-	B5234T3	; With Charger Intercooler	EPBBPN3-V034Z	96381	20	250
2.3 AWD	2.319	177	5	04.1997-09.1998	B5234T3		EPBMPN3-A040Z	94558	20	100
2.3 Turbo	2.319	184	5	12.1995-03.2000	B5234FT+		EPBMPN3-A040Z	94558	20	100



MAP



l kW
C
Y
I



Type-N°

Stock-N°

kPa from
kPa to

VOLVO

V70 I (875, 876)

2.3 T AWD	2.319	184	5	04.1997-03.2000	B5234FT+, B5234T4		EPBMPN3-A040Z	94558	20	100
2.3 AWD	2.319	195	5	01.1999-	B5234T7	; With Charger Intercooler	EPBBPN3-V034Z	96381	20	250
2.3 AWD	2.319	195	5	12.1998-02.2000	B5234T8	; With Charger Intercooler	EPBBPN3-V034Z	96381	20	250
2.3 AWD	2.319	195	5	12.1998-02.2000	B5234T7, B5234T8		EPBMPN3-A040Z	94558	20	100
2.4 Bifuel	2.435	103	5	08.1999-12.2000	B5244SG		EPBMPN3-A023Z	96241	10	130
2.4	2.435	103	5	03.1999-12.2000	B5244S2, B5244SG2		EPBMPN3-A023Z	96241	10	130
2.4 Bifuel	2.435	106	5	05.1998-12.1999	GB5252S		EPBMPN3-A003Z	92477	15	102
2.4	2.435	106	5	12.1995-03.2000	B5252FS		EPBMPN3-A003Z	92477	15	102
2.4	2.435	121	5	01.1999-	B5254S		EPBMPN3-A023Z	96241	10	130
2.4	2.435	125	5	12.1995-05.2000	B5254S, B5244S, B5254FS		EPBMPN3-A023Z	96241	10	130
2.4 Turbo AWD	2.435	142	5	01.1999-	B5254T	; With Charger Intercooler	EPBBPN3-V034Z	96381	20	250
2.4 Turbo	2.435	142	5	04.1996-12.2000	B5244T	; With Charger Intercooler	EPBBPN3-V034Z	96381	20	250
2.4 Turbo	2.435	142	5	04.1996-12.2000	B5244T		EPBMPN3-A040Z	94558	20	100
2.4 Turbo AWD	2.435	142	5	04.1996-12.2000	B5254T		EPBMPN3-A040Z	94558	20	100
2.4 Turbo AWD	2.435	195	5	03.1999-12.2000	B5244T2		EPBMPN3-A040Z	94558	20	100
2.5 TDi AWD	2.460	103	5	11.1996-02.2000	D5252T		EPBBPN3-A013Z	95023	30	245
2.5 TDI	2.461	103	5	12.1995-12.2000	D5252T		EPBBPN3-A013Z	95023	30	245

V70 II (285)

2.0 T	1.984	132	5	-01.2002	B5204T5	; With Charger Intercooler	EPBBPN3-V034Z	96381	20	250
2.0 T	1.984	132	5	01.2003-	B5204T5	; With Charger Intercooler	EPBBPT4-V013Z	91803	20	250
2.3 T5	2.319	184	5	-01.2002	B5234T3	; With Charger Intercooler	EPBBPN3-V034Z	96381	20	250
2.3 T5	2.319	184	5	01.2003-	B5234T3	; With Charger Intercooler	EPBBPT4-V013Z	91803	20	250
2.3	2.319	195	5	-01.2002	B5234T7	; With Charger Intercooler	EPBBPN3-V034Z	96381	20	250
2.3	2.319	195	5	01.2003-	B5234T7	; With Charger Intercooler	EPBBPT4-V013Z	91803	20	250
2.4 D	2.401	96	5	07.2001-08.2007	D5244T2	; With Charger Intercooler	EPBBPT4-V013Z	91803	20	250
2.4	2.435	103	5	03.2000-08.2007	B5244S2		EPBMPN3-A014Z	90281	10	130
2.4	2.435	103	5	03.2000-08.2007	B5244S2		EPBBPT4-V018Z	91887	50	600
2.4 Bifuel CNG	2.435	103	5	09.2001-08.2007	B5244SG		EPBMPN3-A037Z	94170	10	130
2.4 Bifuel CNG	2.435	103	5	09.2001-08.2007	B5244SG		EPBBPT4-V018Z	91887	50	600
2.4 Bifuel LPG	2.435	103	5	09.2001-08.2007	B5244SG2		EPBMPN3-A037Z	94170	10	130
2.4 Bifuel LPG	2.435	103	5	09.2001-08.2007	B5244SG2		EPBBPT4-V018Z	91887	50	600
2.4 D5	2.401	120	5	01.2001-12.2008	D5244T	; With Charger Intercooler	EPBBPT4-V013Z	91803	20	250
2.4 D5 AWD	2.401	120	5	07.2002-08.2007	D5244T2	; With Charger Intercooler	EPBBPT4-V013Z	91803	20	250
2.4	2.435	125	5	03.2000-08.2007	B5244S		EPBMPN3-A014Z	90281	10	130
2.4	2.435	125	5	03.2000-08.2007	B5244S		EPBBPT4-V018Z	91887	50	600
2.4 T	2.435	147	5	-01.2002	B5244T3		EPBBPN3-V034Z	96381	20	250
2.4 T AWD	2.435	147	5	-01.2002	B5244T3		EPBBPN3-V034Z	96381	20	250



MAP



l kW
C
Y
I



Type-N°

Stock-N°

kPa from

kPa to

VOLVO

V70 II (285)

2.4 T	2.435	147	5	01.2003-	B5244T3		EPBBPT4-V013Z	91803	20	250
2.4 T AWD	2.435	147	5	01.2003-	B5244T3		EPBBPT4-V013Z	91803	20	250
2.5 TDI	2.461	103	5	11.1999- 08.2007	D5252T		EPBBPN3-A013Z	95023	30	245
2.5 T	2.521	154	5	07.2001- 08.2007	B5254T2	; With Charger Intercooler	EPBBPT4-V013Z	91803	20	250
2.5 T AWD	2.521	154	5	07.2002- 08.2007	B5254T2	; With Charger Intercooler	EPBBPT4-V013Z	91803	20	250
2.5 AWD	2.521	155	5	09.2002- 12.2004	B5254T2	; With Charger Intercooler	EPBBPT4-V013Z	91803	20	250
2.5 T AWD R	2.521	221	5	03.2003- 08.2007	B5254T4		EPBBPT4-V009Z	95675	20	300

V70 III (135)

1.6 D	1.560	80	4	07.2009- 12.2011	D4164T		EPBBPN3-A001Z	94263	10	240
1.6 DRiVe, D2	1.560	84	4	04.2011- 12.2015	D4162T	; Position: Intake Manifold	EPBMBT4-A003Z	93024	12,9	316,5
1.6 T4	1.596	132	4	10.2010- 12.2015	B4164T		EPBMPN3-V019Z	93061	10	307,5
1.6 T4	1.596	132	4	10.2010- 12.2015	B4164T		EPBBPT4-V001Z	92565	11	307
1.6 T4F	1.596	132	4	01.2011- 12.2015	B4164T2		EPBMPN3-V019Z	93061	10	307,5
1.6 T4F	1.596	132	4	01.2011- 12.2015	B4164T2		EPBBPT4-V001Z	92565	11	307
2.0 D3	1.984	100	5	10.2007- 12.2015	D5204T7		EPBBPN4-A020Z	92413	50	350
2.0 D	1.997	100	4	10.2007- 12.2015	D4204T		EPBBPN3-A001Z	94263	10	240
2.0	1.999	107	4	-07.2011	B4204S3		EPBMPT4-A017Z	96798	10	115
2.0 FlexiFuel	1.999	107	4	-07.2011	B4204S4		EPBMPT4-A017Z	96798	10	115
2.0 D4	1.984	120	5	08.2010- 07.2015	D5204T2, D5204T3		EPBBPN4-A020Z	92413	50	350
2.0 T	1.999	149	4	09.2009- 12.2011	B4204T6		EPBMPN3-V019Z	93061	10	307,5
2.0 T	1.999	149	4	09.2009- 12.2011	B4204T6		EPBBPT4-V009Z	95675	20	300
2.0 T5	1.999	177	4	01.2010- 12.2014	B4204T7		EPBMPN3-V019Z	93061	10	307,5
2.0 T5	1.999	177	4	01.2010- 12.2014	B4204T7		EPBBPT4-V009Z	95675	20	300
2.4 D	2.400	120	5	04.2007- 12.2010	D5244T19, D5244T5		EPBBPT4-V009Z	95675	20	300
2.4 D4 AWD	2.400	120	5	10.2007- 12.2015	D5244T17		EPBBPN4-A020Z	92413	50	350
2.4 D	2.400	129	5	04.2009- 12.2010	D5244T14		EPBBPN4-A020Z	92413	50	350
2.4 D4 AWD	2.400	133	5	10.2013-	D5244T12		EPBBPN4-A020Z	92413	50	350
2.4 D5	2.400	136	5	04.2007- 12.2009	D5244T4		EPBBPT4-V009Z	95675	20	300
2.4 D5	2.400	151	5	10.2008- 12.2011	D5244T10		EPBBPT4-V009Z	95675	20	300
2.4 D5	2.400	151	5	10.2008- 12.2011	D5244T10		EPBBPN4-A020Z	92413	50	350
2.4 D5 AWD	2.400	151	5	12.2009- 12.2011	D5244T10		EPBBPT4-V009Z	95675	20	300
2.4 D5 AWD	2.400	151	5	12.2009- 12.2011	D5244T10		EPBBPN4-A020Z	92413	50	350
2.4 D5	2.400	158	5	04.2011- 12.2015	D5244T11, D5244T15		EPBBPN4-A020Z	92413	50	350
2.4 D5 AWD	2.400	158	5	04.2011- 12.2015	D5244T15		EPBBPN4-A020Z	92413	50	350
2.4 D5 AWD	2.401	136	5	04.2007- 12.2009	D5244T4		EPBBPT4-V009Z	95675	20	300
2.5 T FlexiFuel	2.521	147	5	05.2008- 12.2009	B5254T8		EPBBPT4-V009Z	95675	20	300
2.5 T	2.521	147	5	08.2007- 12.2009	B5254T6		EPBBPT4-V009Z	95675	20	300



MAP



l kW
C
Y
I



Type-N°

Stock-N°

kPa from
kPa to

VOLVO

V70 III (135)

2.5 T FlexiFuel	2.521	170	5	04.2009-12.2011	B5254T11		EPBBPT4-V009Z	95675	20	300
2.5 T	2.521	170	5	04.2009-12.2012	B5254T10		EPBBPT4-V009Z	95675	20	300
3.0 T6 AWD	2.953	210	6	08.2007-12.2010	B6304T2		EPBBPT4-V009Z	95675	20	300
3.0 T6 AWD	2.953	224	6	01.2010-12.2015	B6304T4		EPBBPT4-V009Z	95675	20	300

XC60 (156)

2.0 D3	1.984	100	5	-07.2015	D5204T7		EPBBPN4-A020Z	92413	50	350
2.0 D4	1.984	120	5	03.2010-12.2014	D5204T2, D5204T3		EPBBPN4-A020Z	92413	50	350
2.0 T	1.999	149	4	12.2009-12.2012	B4204T6		EPBMPN3-V019Z	93061	10	307,5
2.0 T	1.999	149	4	12.2009-12.2012	B4204T6		EPBBPT4-V009Z	95675	20	300
2.0 T5	1.999	177	4	09.2010-02.2017	B4204T7		EPBMPN3-V019Z	93061	10	307,5
2.0 T5	1.999	177	4	09.2010-02.2017	B4204T7		EPBBPT4-V009Z	95675	20	300
2.4 D, D3, D4 AWD	2.400	120	5	05.2008-02.2017	D5244T5, D5244T16, D5244T17		EPBBPN4-A020Z	92413	50	350
2.4 D	2.400	129	5	04.2009-12.2010	D5244T14		EPBBPN4-A020Z	92413	50	350
2.4 D4 AWD	2.400	133	5	-07.2015	D5244T12		EPBBPN4-A020Z	92413	50	350
2.4 D4 AWD	2.400	140	5	03.2015-02.2017	D5244T21		EPBBPN4-A020Z	92413	50	350
2.4 D5 AWD	2.400	151	5	07.2009-06.2011	D5244T10		EPBBPN4-A020Z	92413	50	350
2.4 D5 AWD	2.400	162	5	03.2015-02.2017	D5244T20, D5244T22		EPBBPN4-A020Z	92413	50	350
3.0 T6 AWD	2.953	224	6	03.2010-02.2017	B6304T4		EPBBPT4-V009Z	95675	20	300

XC70 CROSS COUNTRY (295) | V70 XC

2.4 D5 AWD	2.401	136	5	12.2005-08.2007	D5244T4		EPBBPT4-V009Z	95675	20	300
2.4 T XC AWD	2.435	147	5	-01.2002	B5244T3	: With Charger Intercooler	EPBBPN3-V034Z	96381	20	250
2.4 T XC AWD	2.435	147	5	01.2003-	B5244T3	: With Charger Intercooler	EPBBPT4-V013Z	91803	20	250
2.5 T XC AWD	2.521	154	5	09.2002-08.2007	B5254T2	: With Charger Intercooler	EPBBPT4-V013Z	91803	20	250

XC70 II (136)

2.0 D3	1.984	120	5	04.2010-12.2015	D5204T2, D5204T3		EPBBPN4-A020Z	92413	50	350
2.4 D, D4 AWD	2.400	120	5	08.2007-	D5244T5, D5244T16, D5244T17		EPBBPT4-V009Z	95675	20	300
2.4 D, D4 AWD	2.400	120	5	08.2007-	D5244T5, D5244T16, D5244T17		EPBBPN4-A020Z	92413	50	350
2.4 D	2.400	129	5	06.2009-12.2010	D5244T14		EPBBPT4-V009Z	95675	20	300
2.4 D	2.400	129	5	06.2009-12.2010	D5244T14		EPBBPN4-A020Z	92413	50	350
2.4 D4 AWD	2.400	133	5	10.2013-	D5244T12		EPBBPN4-A020Z	92413	50	350
2.4 D5 AWD	2.400	136	5	04.2007-12.2009	D5244T4		EPBBPT4-V009Z	95675	20	300
2.4 D5 AWD	2.400	151	5	04.2009-12.2011	D5244T10		EPBBPT4-V009Z	95675	20	300
2.4 D5 AWD	2.400	151	5	04.2009-12.2011	D5244T10		EPBBPN4-A020Z	92413	50	350
2.4 D5 AWD	2.400	158	5	04.2011-12.2015	D5244T11, D5244T15		EPBBPN4-A020Z	92413	50	350
3.0 T6 AWD	2.953	210	6	01.2008-	B6304T2		EPBBPT4-V009Z	95675	20	300
3.0 T6 AWD	2.953	224	6	01.2010-	B6304T4		EPBBPT4-V009Z	95675	20	300



MAP



l kW
C
Y
I



Type-N°

Stock-N°

kPa from

kPa to

VOLVO

XC90 I (275)

2.4 D3, D5	2.400	120	5	04.2009-12.2014	D5244T5		EPBBPT4-V009Z	95675	20	300
2.4 D5 AWD	2.401	136	5	04.2005-12.2010	D5244T4		EPBBPT4-V009Z	95675	20	300
2.4 D5 AWD	2.400	147	5	01.2011-12.2014	D5244T18		EPBBPT4-V009Z	95675	20	300

VW

AMAROK (2HA, 2HB, S1B, S6B, S7A, S7B)

2.0 TDI	1.968	90	4	09.2010-10.2013	CDBA, CNFA	; Position: Air Filter Housing	EPBMPT4-V008Z	96201	10	117
2.0 TDI 4motion	1.968	90	4	09.2010-10.2013	CDBA, CNFA	; Position: Air Filter Housing	EPBMPT4-V008Z	96201	10	117
2.0 TDI	1.968	103	4	09.2011-10.2016	CNFB	; Position: Air Filter Housing	EPBMPT4-V008Z	96201	10	117
2.0 TDI 4motion	1.968	103	4	09.2011-10.2016	CNFB	; Position: Air Filter Housing	EPBMPT4-V008Z	96201	10	117
2.0 BiTDI	1.968	120	4	09.2010-08.2012	CDCA	; Position: Air Filter Housing	EPBMPT4-V008Z	96201	10	117
2.0 BiTDI 4motion	1.968	120	4	09.2010-08.2012	CDCA	; Position: Air Filter Housing	EPBMPT4-V008Z	96201	10	117
2.0 BiTDI	1.968	132	4	11.2011-	CNEA, CSHA	; Position: Air Filter Housing	EPBMPT4-V008Z	96201	10	117
2.0 BiTDI 4motion	1.968	132	4	11.2011-	CNEA, CSHA	; Position: Air Filter Housing	EPBMPT4-V008Z	96201	10	117
2.0 TSI	1.984	118	4	12.2010-10.2016	CFPA	; Position: Air Filter Housing	EPBMPT4-V008Z	96201	10	117
2.0 TSI	1.984	118	4	12.2010-10.2016	CFPA		EPBBPT4-V002Z	95912	20	300

BEETLE (5C1, 5C2, 5C7, 5C8)

1.4 TSI	1.390	118	4	10.2011-07.2016	CAVD, CNWA, CTHD, CTKA	; Position: Intake Manifold; Position: Throttle Housing	EPBBPT4-V002Z	95912	20	300
1.6 TDI	1.598	77	4	10.2011-07.2016	CAYC		EPBBPT4-V002Z	95912	20	300
2.0 TDI	1.968	103	4	04.2011-07.2016	CFFB, CJAA		EPBBPT4-V002Z	95912	20	300
2.0 TSI	1.984	147	4	04.2011-07.2016	CBFA, CCTA, CCZA		EPBBPT4-V002Z	95912	20	300
2.0 TSI	1.984	147	4	04.2011-07.2016	CCTA, CBFA, CCZA		EPBBPN4-V014Z	93428	20	250
2.0 TSI	1.984	155	4	12.2012-07.2019	CPLA, CPPA	; For vehicles with electric auxiliary air pump	EPBBPT4-V002Z	95912	20	300
2.5	2.480	125	5	04.2011-07.2019	CBTA, CBUA, CCCA		EPBMPT4-V008Z	96201	10	117

BORA (1J2, 1J6)

1.4 16V	1.390	55	4	03.2000-05.2005	APE, AXP, BCA		EPBMPT4-D005Z	93653	17	117
1.4 16V	1.390	55	4	03.2000-05.2005	AHW, AKQ, AXP, BCA		EPBMPT4-V004Z	92899	20	115
1.6 16V	1.598	77	4	05.2000-05.2005	ATN, AUS, AZD, BCB		EPBMPT4-V004Z	92899	20	115
1.6 FSI	1.598	81	4	01.2002-05.2005	BAD		EPBMPN4-V041Z	94063	10	115
1.8 T	1.781	110	4	05.2000-05.2005	AGU, AUM	; Chass. >1J-3-525001	EPBBPT4-V003Z	91742	20	254
1.8 T	1.781	110	4	05.2000-05.2005	AGU, AUM	; Chass. <1J-3525000	EPBMBT4-D001Z	91628	11	254
1.8 T	1.781	132	4	03.2002-05.2005	AUQ	; Chass. <1J-3525000	EPBMBT4-D001Z	91628	11	254
1.8 T	1.781	132	4	03.2002-05.2005	AUQ, AWP	; Chass. >1J-3-525001	EPBBPT4-V003Z	91742	20	254
1.9 TDI	1.896	66	4	10.1998-05.2005	AGR, ALH	; Chass. >1J-3-525001	EPBBPT4-V003Z	91742	20	254
1.9 TDI	1.896	66	4	10.1998-05.2005	AGR, ALH	; Chass. <1J-3525000	EPBMBT4-D001Z	91628	11	254
1.9 TDI 4motion	1.896	66	4	11.1998-04.2002	AGR	; Chass. <1J-3525000	EPBMBT4-D001Z	91628	11	254
1.9 TDI 4motion	1.896	66	4	11.1998-04.2002	AGR	; Chass. >1J-3-525001	EPBBPT4-V003Z	91742	20	254



MAP



l kW
C
Y
I



Type-N°

Stock-N°

kPa from
kPa to

VW

BORA (1J2, 1J6)

1.9 TDI	1.896	74	4	09.2000-05.2005	ATD, AXR, BEW	; Chass. >1J-3-525001	EPBBPT4-V003Z	91742	20	254
1.9 TDI	1.896	74	4	09.2000-05.2005	ATD	; Chass. <1J-3525000	EPBMBT4-D001Z	91628	11	254
1.9 TDI	1.896	74	4	09.2000-05.2005	AXR		EPBMBT4-D001Z	91628	11	254
1.9 TDI 4motion	1.896	74	4	09.2000-05.2005	ATD	; Chass. <1J-3525000	EPBMBT4-D001Z	91628	11	254
1.9 TDI 4motion	1.896	74	4	09.2000-05.2005	ATD	; Chass. >1J-3-525001	EPBBPT4-V003Z	91742	20	254
1.9 TDI	1.896	81	4	10.1998-06.2001	AHF, ASV	; Chass. >1J-3-525001	EPBBPT4-V003Z	91742	20	254
1.9 TDI	1.896	81	4	10.1998-06.2001	AHF, ASV	; Chass. <1J-3525000	EPBMBT4-D001Z	91628	11	254
1.9 TDI	1.896	96	4	11.2000-05.2005	ASZ		EPBBPT4-V002Z	95912	20	300
1.9 TDI 4motion	1.896	96	4	11.2000-05.2005	ASZ		EPBBPT4-V002Z	95912	20	300
1.9 TDI	1.896	110	4	05.2000-05.2005	ARL		EPBBPT4-V015Z	94877	20	300
1.9 TDI 4motion	1.896	110	4	05.2000-05.2005	ARL		EPBBPT4-V015Z	94877	20	300

CADDY II (9K9A, 9K9B, 9U7)

1.4, 60 1.4	1.390	44	4	09.2000-06.2003	AUD		EPBMPT4-D005Z	93653	17	117
1.4	1.390	44	4	11.1995-01.2004	AEX, AKV, APQ, AUD		EPBMPT4-D025Z	92358	17	115
1.4 16V	1.390	55	4	08.2000-01.2004	AUA		EPBMPT4-D025Z	92358	17	115
1.6, 75 1.6	1.598	55	4	11.1995-12.2000	AEE		EPBMPT4-V004Z	92899	20	115
1.9 TDI	1.896	66	4	09.1996-01.2004	1Z, AHU, ALE	; Position: Air Filter Housing	EPBMPN3-A027Z	90915	20	105

CADDY III (2KA, 2KH, 2CA, 2CH, 2KB, 2KJ, 2CB, 2CJ)

1.4	1.390	55	4	03.2004-05.2006	BCA		EPBMPT4-V008Z	96201	10	117
1.4	1.390	59	4	05.2006-08.2010	BUD		EPBMPT4-V008Z	96201	10	117
1.6	1.595	75	4	04.2004-05.2015	BGU, BSE, BSF		EPBMPT4-D005Z	93653	17	117
1.6 BiFuel	1.595	75	4	05.2011-05.2015	CHGA		EPBMPT4-D005Z	93653	17	117
1.6 TDI	1.598	55	4	08.2010-05.2015	CAYE		EPBBPT4-V002Z	95912	20	300
1.6 TDI	1.598	75	4	08.2010-05.2015	CAYD		EPBBPT4-V002Z	95912	20	300
1.9 TDI	1.896	55	4	09.2005-08.2010	BSU		EPBBPT4-V003Z	91742	20	254
1.9 TDI	1.896	77	4	04.2004-08.2010	BJB, BLS		EPBBPT4-V003Z	91742	20	254
1.9 TDI 4motion	1.896	77	4	05.2008-08.2010	BLS		EPBBPT4-V003Z	91742	20	254
2.0 SDI	1.968	51	4	03.2004-08.2010	BDJ, BST		EPBBPT4-V003Z	91742	20	254
2.0 TDI	1.968	62	4	11.2010-05.2015	CFHE		EPBBPT4-V002Z	95912	20	300
2.0 TDI 4motion	1.968	62	4	12.2010-05.2015	CFHE		EPBBPT4-V002Z	95912	20	300
2.0 EcoFuel	1.984	80	4	04.2006-05.2015	BSX		EPBMPT4-V008Z	96201	10	117
2.0 TDI	1.968	81	4	08.2010-05.2015	CLCA		EPBBPT4-V002Z	95912	20	300
2.0 TDI 4motion	1.968	81	4	08.2010-05.2015	CFHF		EPBBPT4-V002Z	95912	20	300
2.0 TDI	1.968	103	4	09.2007-08.2010	BMM		EPBBPT4-V002Z	95912	20	300
2.0 TDI	1.968	103	4	09.2007-08.2010	BMM		EPBBPT4-V003Z	91742	20	254
2.0 TDI 16V	1.968	103	4	11.2010-05.2015	CFHC, CLCB		EPBBPT4-V002Z	95912	20	300
2.0 TDI 16V 4motion	1.968	103	4	11.2010-05.2015	CFHC		EPBBPT4-V002Z	95912	20	300



MAP



l kW
C
Y
I



Type-N°

Stock-N°

kPa from

kPa to

VW

CADDY III (2KA, 2KH, 2CA, 2CH, 2KB, 2KJ, 2CB, 2CJ)

2.0 TDI	1.968	125	4	05.2012-05.2015	CFJA		EPBBPT4-V002Z	95912	20	300
---------	-------	-----	---	-----------------	------	--	---------------	-------	----	-----

CADDY IV (SAA, SAH, SAB, SAJ)

1.0 TSI	999	75	3	11.2015-	CHZG		EPBBPT4-V002Z	95912	20	300
1.0 TSI Alltrack	999	75	3	11.2015-	CHZG		EPBBPT4-V002Z	95912	20	300
1.2 TSI	1.197	62	4	06.2015-	CYVC		EPBBPT4-V002Z	95912	20	300
1.2 TSI Alltrack	1.197	62	4	06.2015-	CYVC		EPBBPT4-V002Z	95912	20	300
1.4 TGI CNG	1.395	81	4	06.2015-	CPWA		EPBBPT4-V002Z	95912	20	300
1.4 TGI CNG Alltrack	1.395	81	4	06.2015-	CPWA		EPBBPT4-V002Z	95912	20	300
1.4 TSI	1.395	92	4	05.2015-	CZCB		EPBBPT4-V002Z	95912	20	300
1.4 TSI Alltrack	1.395	92	4	05.2015-	CZCB		EPBBPT4-V002Z	95912	20	300
1.6 TDI	1.598	55	4	05.2015-11.2017	CAYE		EPBBPT4-V002Z	95912	20	300
1.6 TDI	1.598	75	4	05.2015-	CAYD		EPBBPT4-V002Z	95912	20	300
1.6	1.598	81	4	11.2015-	CWVA		EPBMP4-V008Z	96201	10	117
2.0 TDI 4motion	1.968	81	4	05.2015-05.2016	CFHF, CLCA		EPBBPT4-V002Z	95912	20	300
2.0 TDI	1.968	103	4	05.2015-	CFHC, CLCB		EPBBPT4-V002Z	95912	20	300
2.0 TDI 4motion	1.968	103	4	05.2015-	CFHC		EPBBPT4-V002Z	95912	20	300

CC (358)

1.4 TSI	1.395	110	4	05.2015-12.2016	CZDA		EPBBPT4-V002Z	95912	20	300
1.4 TSI	1.390	118	4	11.2011-12.2016	CTHD	; Position: Intake Manifold; Position: Throttle Housing	EPBBPT4-V002Z	95912	20	300
1.4 TSI MultiFuel	1.390	118	4	11.2011-12.2016	CKMA	; Position: Intake Manifold; Position: Throttle Housing	EPBBPT4-V002Z	95912	20	300
2.0 TDI	1.968	100	4	11.2011-12.2016	CFFA		EPBBPT4-V002Z	95912	20	300
2.0 TDI	1.968	103	4	11.2011-12.2016	CFFB		EPBBPT4-V002Z	95912	20	300
2.0 TDI 4motion	1.968	103	4	11.2011-12.2016	CFFB		EPBBPT4-V002Z	95912	20	300
2.0 TDI	1.968	125	4	11.2011-12.2016	CFGB, CLLA		EPBBPT4-V002Z	95912	20	300
2.0 TDI 4motion	1.968	125	4	11.2011-01.2013	CFGB		EPBBPT4-V002Z	95912	20	300
2.0 TDI	1.968	130	4	12.2012-12.2016	CFGC		EPBBPT4-V002Z	95912	20	300
2.0 TDI 4motion	1.968	130	4	12.2012-12.2016	CFGC		EPBBPT4-V002Z	95912	20	300

CRAFTER (2E_, 2F_)

2.0 TDI	1.968	80	4	05.2011-12.2016	CKTB, CSLA		EPBMPN3-A004Z	90833	10	120
2.0 TDI	1.968	84	4	11.2013-12.2016	CSLB		EPBMPN3-A004Z	90833	10	120
2.0 TDI	1.968	100	4	05.2011-12.2016	CKTC		EPBMPN3-A004Z	90833	10	120
2.0 TDI	1.968	103	4	11.2015-12.2016	CSLC		EPBMPN3-A004Z	90833	10	120
2.0 TDI	1.968	105	4	10.2011-12.2016	CKUC		EPBMPN3-A004Z	90833	10	120
2.0 TDI	1.968	120	4	07.2011-12.2016	CKUB, CSNA		EPBMPN3-A004Z	90833	10	120
2.0 TDI 4motion	1.968	120	4	07.2011-12.2016	CKUB		EPBMPN3-A004Z	90833	10	120
2.0 TDI 4motion	1.968	120	4	07.2011-12.2016	CSNA	; Position: Air Filter Housing	EPBMPN3-A004Z	90833	10	120



MAP



l kW
C
Y
I



Type-N°

Stock-N°

kPa from
kPa to

VW

CRAFTER (2E_, 2F_)

2.5 TDI	2.461	65	5	04.2006-07.2011	BJJ, CEBA		EPBBPT4-V002Z	95912	20	300
2.5 TDI	2.461	65	5	04.2006-07.2011	BJJ, CEBA	; Position: Air Filter Housing	EPBMPN3-A004Z	90833	10	120
2.5 TDI	2.461	80	5	04.2006-05.2013	BJK, CEBB		EPBBPT4-V002Z	95912	20	300
2.5 TDI	2.461	80	5	04.2006-05.2013	BJK, CEBB	; Position: Air Filter Housing	EPBMPN3-A004Z	90833	10	120
2.5 TDI	2.461	100	5	04.2006-05.2013	BJL, CECA		EPBBPT4-V002Z	95912	20	300
2.5 TDI	2.461	100	5	04.2006-05.2013	BJL, CECA	; Position: Air Filter Housing	EPBMPN3-A004Z	90833	10	120
2.5 TDI	2.461	120	5	04.2006-07.2011	BJM, CECB		EPBBPT4-V002Z	95912	20	300
2.5 TDI	2.461	120	5	04.2006-07.2011	BJM, CECB	; Position: Air Filter Housing	EPBMPN3-A004Z	90833	10	120

EOS (1F7, 1F8)

1.4 TSI	1.390	90	4	11.2007-08.2015	CAXA		EPBBPT4-V003Z	91742	20	254
1.4 TSI	1.390	118	4	05.2008-08.2015	CAVD, CTHD		EPBBPT4-V002Z	95912	20	300
1.6 FSI	1.598	85	4	06.2006-05.2008	BLF	; Position: Suction Pipe	EPBMPT4-V008Z	96201	10	117
2.0 TDI	1.968	100	4	11.2010-08.2015	CFFA		EPBBPT4-V002Z	95912	20	300
2.0 TDI	1.968	103	4	06.2006-05.2008	BMM		EPBBPT4-V002Z	95912	20	300
2.0 TDI 16V	1.968	103	4	05.2008-08.2015	CBAB, CFFB		EPBBPT4-V002Z	95912	20	300
2.0 FSI	1.984	110	4	03.2006-05.2008	BVY, BVZ		EPBMPT4-D005Z	93653	17	117
3.2 V6	3.189	184	6	06.2006-05.2009	BUB, CBRA		EPBMPT4-D042Z	91710		

FOX (5Z1, 5Z3, 5Z4)

1.2	1.198	40	3	04.2005-07.2011	BMD, CHFB		EPBMPT4-V011Z	91119	20	115
1.2	1.198	44	3	09.2010-12.2011	CHFA		EPBMPT4-V011Z	91119	20	115
1.4 TDI	1.422	51	3	04.2005-12.2009	BNM		EPBBPT4-V003Z	91742	20	254
1.4	1.390	55	4	04.2005-12.2009	BKR		EPBMPT4-V008Z	96201	10	117
1.6	1.598	74	4	10.2003-08.2014	BAH, BPA, BLH, CCRA, CFZA		EPBMPT4-V008Z	96201	10	117
1.6 Total Flex	1.598	74	4	10.2003-08.2014	BJA, BPA, CCRA		EPBMPT4-V008Z	96201	10	117

GOLF III (1H1, 1H5)

1.4	1.390	40	4	11.1991-08.1997	ABD, AEX		EPBMPT4-D025Z	92358	17	115
1.4	1.390	44	4	07.1993-04.1999	ABD, AEX, APQ		EPBMPT4-D025Z	92358	17	115
1.6	1.598	55	4	09.1992-08.1997	ABU, AEA, AEE		EPBMPT4-V004Z	92899	20	115

GOLF IV (1J1, 1E7, 1J5)

1.4 16V	1.390	55	4	10.1997-06.2006	APE, AXP, BCA		EPBMPT4-D005Z	93653	17	117
1.4 16V	1.390	55	4	10.1997-06.2006	AHW, AKQ		EPBMPT4-V004Z	92899	20	115
1.6 16V	1.598	77	4	02.2000-06.2006	ATN, AUS, AZD, BCB		EPBMPT4-V004Z	92899	20	115
1.8 T	1.781	110	4	08.1997-06.2006	AGU, AUM	; Chass. >1J-3525001	EPBBPT4-V003Z	91742	20	254
1.8 T	1.781	110	4	08.1997-06.2006	AGU, AUM	; Chass. <1J-3525000	EPBMBT4-D001Z	91628	11	254
1.8 T GTI	1.781	132	4	08.2001-06.2005	AUQ	; Chass. <1J-3525000	EPBMBT4-D001Z	91628	11	254
1.8 T GTI	1.781	132	4	08.2001-06.2005	AUQ, AWP	; Chass. >1J-3525001	EPBBPT4-V003Z	91742	20	254
1.9 SDI	1.896	50	4	08.1997-06.2006	AGP		EPBMBT4-D001Z	91628	11	254



MAP



l kW
C
Y
I



Type-N°

Stock-N°

kPa from

kPa to

VW

GOLF IV (1J1, 1E7, 1J5)

1.9 TDI	1.896	66	4	10.1997-05.2006	AGR, ALH	; Chass. >1J-3	EPBBPT4-V003Z	91742	20	254
1.9 TDI	1.896	66	4	10.1997-05.2006	AGR, ALH	; Chass. <1J-3W385000; Chass. <1J-3P278330; Chass. <1J-3D390630; Chass. <1J-3B139990; Chass. <1-3U346620	EPBMBT4-D001Z	91628	11	254
1.9 TDI 4motion	1.896	66	4	07.1998-04.2002	AGR	; Chass. <1J-3W385000; Chass. <1J-3P278330; Chass. <1J-3D390630; Chass. <1J-3B139990; Chass. <1-3U346620	EPBMBT4-D001Z	91628	11	254
1.9 TDI 4motion	1.896	66	4	07.1998-04.2002	AGR	; Chass. >1J-3	EPBBPT4-V003Z	91742	20	254
1.9 TDI	1.896	74	4	09.2000-06.2005	ATD	; Chass. <1J-3W385000; Chass. <1J-3P278330; Chass. <1J-3D390630; Chass. <1J-3B139990; Chass. <1-3U346620	EPBMBT4-D001Z	91628	11	254
1.9 TDI	1.896	74	4	09.2000-06.2005	ATD, AXR	; Chass. >1J-3	EPBBPT4-V003Z	91742	20	254
1.9 TDI 4motion	1.896	74	4	09.2000-06.2006	ATD	; Chass. <1J-3W385000; Chass. <1J-3P278330; Chass. <1J-3D390630; Chass. <1J-3B139990; Chass. <1-3U346620	EPBMBT4-D001Z	91628	11	254
1.9 TDI 4motion	1.896	74	4	09.2000-06.2006	ATD	; Chass. >1J-3	EPBBPT4-V003Z	91742	20	254
1.9 TDI	1.896	81	4	08.1997-05.2004	AHF (08.97-), ASV	; Chass. >1J-3	EPBBPT4-V003Z	91742	20	254
1.9 TDI	1.896	81	4	08.1997-05.2004	AHF, ASV	; Chass. <1J-3W385000; Chass. <1J-3P278330; Chass. <1J-3D390630; Chass. <1J-3B139990; Chass. <1-3U346620	EPBMBT4-D001Z	91628	11	254
1.9 TDI	1.896	85	4	08.1999-06.2001	AJM, AUJ		EPBMBT4-D001Z	91628	11	254
1.9 TDI 4motion	1.896	85	4	05.1999-06.2001	AJM, AUJ		EPBMBT4-D001Z	91628	11	254
1.9 TDI	1.896	96	4	11.2000-06.2006	ASZ		EPBBPT4-V002Z	95912	20	300
1.9 TDI 4motion	1.896	96	4	11.2000-06.2006	ASZ		EPBBPT4-V002Z	95912	20	300
1.9 TDI	1.896	110	4	05.2000-06.2005	ARL		EPBBPT4-V015Z	94877	20	300
1.9 TDI 4motion	1.896	110	4	02.2000-06.2005	ARL		EPBBPT4-V015Z	94877	20	300

GOLF V (1K1,1K5)

1.4 16V	1.390	55	4	10.2003-05.2006	BCA		EPBMPT4-V008Z	96201	10	117
1.4 16V	1.390	59	4	05.2006-07.2009	BUD		EPBMPT4-V008Z	96201	10	117
1.4 FSI	1.390	66	4	10.2003-07.2006	BKG, BLN		EPBMPT4-V008Z	96201	10	117
1.4 TSI	1.390	90	4	05.2007-07.2009	CAXA		EPBBPT4-V003Z	91742	20	254
1.4 TSI	1.390	103	4	05.2006-07.2009	BMY		EPBBPT4-V002Z	95912	20	300
1.4 TSI	1.390	118	4	07.2008-07.2009	CAVD		EPBBPT4-V002Z	95912	20	300
1.4 TSI	1.390	125	4	11.2005-07.2009	BLG		EPBBPT4-V002Z	95912	20	300
1.6	1.595	75	4	01.2004-07.2009	CCSA		EPBMPT4-V008Z	96201	10	117
1.6	1.595	75	4	01.2004-11.2008	BGU, BSE, BSF, CCSA		EPBMPT4-D005Z	93653	17	117
1.6 MultiFuel	1.595	75	4	10.2007-07.2009	CCSA		EPBMPT4-V008Z	96201	10	117
1.6 FSI	1.598	85	4	10.2003-07.2008	BAG, BLF, BLP		EPBMPT4-V008Z	96201	10	117
1.9 TDI	1.896	66	4	05.2004-11.2008	BRU, BXF, BXJ		EPBBPT4-V003Z	91742	20	254



MAP



l kW
C
Y
I



Type-N°

Stock-N°

kPa from
kPa to

VW

GOLF V (1K1,1K5)

1.9 TDI	1.896	77	4	10.2003-07.2009	BKC, BLS, BXE		EPBBPT4-V003Z	91742	20	254
1.9 TDI 4motion	1.896	77	4	08.2004-07.2009	BKC, BLS, BXE		EPBBPT4-V003Z	91742	20	254
2.0 SDI	1.968	55	4	01.2004-11.2008	BDK		EPBBPT4-V003Z	91742	20	254
2.0	1.984	85	4	08.2006-11.2008	BHY		EPBMPT4-V008Z	96201	10	117
2.0 TDI	1.968	100	4	10.2003-07.2009	AZV		EPBBPT4-V002Z	95912	20	300
2.0 TDI	1.968	103	4	12.2004-07.2009	BMM		EPBBPT4-V002Z	95912	20	300
2.0 TDI 4motion	1.968	103	4	08.2004-11.2008	BMM		EPBBPT4-V002Z	95912	20	300
2.0 TDI 16V	1.968	103	4	10.2003-07.2009	BKD, CBDB		EPBBPT4-V002Z	95912	20	300
2.0 TDI 16V 4motion	1.968	103	4	08.2004-11.2008	BKD		EPBBPT4-V002Z	95912	20	300
2.0 FSI	1.984	110	4	01.2004-11.2008	AXW, BLR, BLX, BLY, BVX, BZY, BVZ		EPBMPT4-D005Z	93653	17	117
2.0 FSI 4motion	1.984	110	4	08.2004-11.2008	BLX, BVX		EPBMPT4-D005Z	93653	17	117
2.0 TDI	1.968	125	4	11.2005-11.2008	BMN		EPBBPT4-V002Z	95912	20	300
2.0 GTI	1.984	147	4	10.2004-07.2009	AXX, BWA, BPY, CAWB		EPBBPN4-V014Z	93428	20	250
2.0 GTI	1.984	169	4	09.2006-12.2008	BYD		EPBBPT4-V002Z	95912	20	300
3.2 R32 4motion	3.189	184	6	11.2005-11.2008	BUB, CBRA		EPBMPT4-D042Z	91710		

GOLF VI (5K1, AJ5, 517)

1.2 TSI 16V	1.197	77	4	11.2013-05.2016	CYVD	; Position: Intake Manifold	EPBBPT4-V002Z	95912	20	300
1.4	1.390	59	4	10.2008-11.2012	CGGA		EPBMPT4-V008Z	96201	10	117
1.4	1.390	59	4	07.2009-07.2013	BUD, CGGA		EPBMPT4-V008Z	96201	10	117
1.4 TSI	1.390	90	4	10.2008-07.2013	CAXA	; NTC Sensor	EPBBPT4-V003Z	91742	20	254
1.4 TSI	1.395	92	4	11.2013-05.2016	CXSB, CZCA		EPBBPT4-V002Z	95912	20	300
1.4 TSI	1.395	110	4	11.2013-05.2016	CZDA		EPBBPT4-V002Z	95912	20	300
1.4 TSI	1.390	118	4	-05.2010	CAVD, CNWA, CTHD	; NTC Sensor	EPBBPT4-V002Z	95912	20	300
1.4 TSI	1.390	118	4	07.2009-05.2016	CAVD, CNWA, CTHD, CTKA	; NTC Sensor	EPBBPT4-V002Z	95912	20	300
1.6 TDI	1.598	66	4	02.2009-07.2013	CAYB		EPBBPT4-V002Z	95912	20	300
1.6	1.595	75	4	10.2008-07.2013	CCSA		EPBMPT4-V008Z	96201	10	117
1.6	1.595	75	4	10.2008-07.2013	BSE, BSF, CMXA	; NTC Sensor	EPBMPT4-D005Z	93653	17	117
1.6 BiFuel	1.595	75	4	03.2009-11.2012	CHGA		EPBMPT4-D005Z	93653	17	117
1.6 MultiFuel	1.595	75	4	05.2010-	CMXA		EPBMPT4-D005Z	93653	17	117
1.6 MultiFuel	1.595	75	4	10.2008-11.2012	CCSA	; Position: Intake Manifold	EPBMPT4-V008Z	96201	10	117
1.6 TDI	1.598	77	4	02.2009-05.2016	CAYC	; NTC Sensor	EPBBPT4-V002Z	95912	20	300
1.6 TDI 4motion	1.598	77	4	07.2009-07.2013	CAYC		EPBBPT4-V002Z	95912	20	300
1.8 TSI	1.798	118	4	06.2009-01.2011	CDAA	; With Charger Intercooler	EPBBPN4-V014Z	93428	20	250
2.0 TDI	1.968	81	4	10.2008-07.2013	CBDC, CLCA		EPBBPT4-V002Z	95912	20	300
2.0 TDI	1.968	100	4	10.2008-11.2012	CBAA, CFFA		EPBBPT4-V002Z	95912	20	300
2.0 TDI	1.968	103	4	10.2008-05.2013	CBAB	; NTC Sensor	EPBBPT4-V002Z	95912	20	300
2.0 TDI	1.968	103	4	07.2009-07.2013	CBDB, CFHC, CJAA, CLCB		EPBBPT4-V002Z	95912	20	300



MAP



l kW
C
Y
I



Type-N°

Stock-N°

kPa from

kPa to

VW

GOLF VI (5K1, AJ5, 517)

2.0 TDI 4motion	1.968	103	4	05.2009-11.2012	CBAB, CFFB	; NTC Sensor	EPBBPT4-V002Z	95912	20	300
2.0 TDI	1.968	125	4	04.2009-11.2012	CBBB, CFGB	; NTC Sensor	EPBBPT4-V002Z	95912	20	300
2.0 GTi	1.984	147	4	06.2009-11.2013	CCTA, CBFA	; With Charger Intercooler	EPBBPN4-V014Z	93428	20	250
2.0 GTi	1.984	147	4	06.2009-11.2013	CCZA	; With Charger Intercooler; Position: Intake Manifold	EPBBPN4-V014Z	93428	20	250
2.0 TSI	1.984	147	4	07.2009-07.2013	CCZA	; With Charger Intercooler; Position: Intake Manifold	EPBBPN4-V014Z	93428	20	250
2.0 GTi	1.984	155	4	04.2009-11.2012	CCZB	; With Charger Intercooler	EPBBPN4-V014Z	93428	20	250
2.0 TSI	1.984	162	4	11.2013-05.2016	CULC		EPBBPT4-V002Z	95912	20	300
2.0 GTi	1.984	173	4	05.2011-11.2012	CDLG		EPBBPT4-V002Z	95912	20	300
2.0 R 4motion	1.984	188	4	11.2009-11.2013	CDLC, CRZA		EPBBPT4-V002Z	95912	20	300
2.0 R	1.984	195	4	01.2013-05.2016	CDLA		EPBBPT4-V002Z	95912	20	300
2.0 R 4motion	1.984	199	4	11.2009-11.2012	CDLF	; NTC Sensor	EPBBPT4-V002Z	95912	20	300
2.5	2.480	125	5	07.2009-05.2013	CBTA, CBUA		EPBMPT4-V008Z	96201	10	117

GOLF VII (5G1, BQ1, BE1, BE2, BA5, BV5)

1.0 TSI	999	85	3	05.2015-	CHZD		EPBBPT4-V002Z	95912	20	300
1.2 TSI	1.197	63	4	05.2013-	CJZB, CYVA	; Position: Intake Manifold	EPBBPT4-V002Z	95912	20	300
1.2 TSI	1.197	77	4	11.2012-	CJZA	; Position: Intake Manifold	EPBBPT4-V002Z	95912	20	300
1.2 TSI	1.197	81	4	04.2014-	CYVB	; Position: Intake Manifold	EPBBPT4-V002Z	95912	20	300
1.4 TGI CNG	1.395	81	4	06.2013-	CPWA, CZBA	; Position: Intake Manifold	EPBBPT4-V002Z	95912	20	300
1.4 TSI	1.395	90	4	11.2012-	CMBA, CXSA	; Position: Intake Manifold	EPBBPT4-V002Z	95912	20	300
1.4 TSI MultiFuel	1.395	90	4	04.2013-	CPVA	; Position: Intake Manifold	EPBBPT4-V002Z	95912	20	300
1.4 TSI	1.395	92	4	05.2014-	CZCA, CZDD	; Position: Intake Manifold	EPBBPT4-V002Z	95912	20	300
1.4 TSI MultiFuel	1.395	92	4	12.2013-	CPVB	; Position: Intake Manifold	EPBBPT4-V002Z	95912	20	300
1.4 TSI	1.395	103	4	08.2012-	CHPA, CPTA	; Position: Intake Manifold	EPBBPT4-V002Z	95912	20	300
1.4 TSI	1.395	110	4	05.2014-	CHPB, CZDA, CZEA, DGXA	; Position: Intake Manifold	EPBBPT4-V002Z	95912	20	300
1.4 GTE Hybrid	1.395	110	4	05.2014-	CUKB	; Position: Intake Manifold	EPBBPT4-V002Z	95912	20	300
1.6	1.598	81	4	05.2014-	CWVA		EPBMPT4-V008Z	96201	10	117
1.8 TSI 4motion Alltrack	1.798	132	4	12.2014-	CJSB		EPBBPT4-V002Z	95912	20	300
2.0 GTI	1.984	155	4	11.2013-	CNTA, CXCA		EPBBPT4-V002Z	95912	20	300
2.0 GTI	1.984	162	4	04.2013-	CHHB, CNTC, CXCB, CXDA		EPBBPT4-V002Z	95912	20	300
2.0 GTI	1.984	169	4	04.2013-	CHHA, CXDB		EPBBPT4-V002Z	95912	20	300
2.0 GTI Clubsport	1.984	195	4	02.2016-	CJXE		EPBBPT4-V002Z	95912	20	300
2.0 R 4motion	1.984	206	4	11.2013-	CJXB		EPBBPT4-V002Z	95912	20	300
2.0 R 4motion	1.984	221	4	11.2013-	CJXC, DNUE		EPBBPT4-V002Z	95912	20	300

GOLF PLUS (5M1, 521)

1.4 16V	1.390	55	4	01.2005-11.2006	BCA		EPBMPT4-V008Z	96201	10	117
1.4 16V	1.390	59	4	05.2006-12.2013	BUD, CGGA		EPBMPT4-V008Z	96201	10	117



MAP

 e kW
C
Y
I

Type-N°

Stock-N°

 kPa from
kPa to

VW
GOLF PLUS (5M1, 521)

1.4 FSI	1.390	66	4	07.2005-11.2006	BLN		EPBMPT4-V008Z	96201	10	117
1.4 TSI	1.390	90	4	06.2007-12.2013	CAXA		EPBBPT4-V003Z	91742	20	254
1.4 TSI	1.390	103	4	05.2006-06.2008	BMY		EPBBPT4-V002Z	95912	20	300
1.4 TSI	1.390	118	4	06.2008-12.2013	CAVD, CNWA, CTHD		EPBBPT4-V002Z	95912	20	300
1.4 TSI	1.390	125	4	05.2006-06.2008	BLG		EPBBPT4-V002Z	95912	20	300
1.6	1.595	75	4	05.2005-12.2013	CCSA		EPBMPT4-V008Z	96201	10	117
1.6	1.595	75	4	05.2005-12.2013	BSE, BSF	; NTC Sensor	EPBMPT4-D005Z	93653	17	117
1.6 BiFuel	1.595	75	4	05.2009-12.2013	CHGA		EPBMPT4-V008Z	96201	10	117
1.6 BiFuel	1.595	75	4	05.2009-12.2013	CHGA		EPBMPT4-D005Z	93653	17	117
1.6 MultiFuel	1.595	75	4	05.2009-	CCSA, CMXA	; NTC Sensor	EPBMPT4-D005Z	93653	17	117
1.6 MultiFuel	1.595	75	4	11.2007-12.2013	CMXA		EPBMPT4-V008Z	96201	10	117
1.6 TDI	1.598	77	4	03.2009-12.2013	CAYC		EPBBPT4-V002Z	95912	20	300
1.6 FSI	1.598	85	4	12.2004-05.2008	BLF		EPBMPT4-V008Z	96201	10	117
1.9 TDI	1.896	66	4	05.2005-12.2008	BRU, BXF, BXJ		EPBBPT4-V003Z	91742	20	254
1.9 TDI	1.896	77	4	01.2005-01.2009	BKC, BLS, BXE		EPBBPT4-V003Z	91742	20	254
2.0 TDI	1.968	81	4	01.2009-12.2013	CBDC, CLCA		EPBBPT4-V002Z	95912	20	300
2.0 TDI	1.968	96	4	-05.2006	BEE		EPBBPT4-V003Z	91742	20	254
2.0 TDI	1.968	96	4	05.2005-05.2007	BEE		EPBBPT4-V002Z	95912	20	300
2.0 TDI	1.968	100	4	05.2005-12.2013	AZV, CBDA, CFHB		EPBBPT4-V002Z	95912	20	300
2.0 TDI	1.968	103	4	12.2005-05.2011	BMM		EPBBPT4-V002Z	95912	20	300
2.0 TDI 16V	1.968	103	4	01.2005-12.2013	BKD, CBDB, CFHC		EPBBPT4-V002Z	95912	20	300
2.0 FSI	1.984	110	4	05.2005-06.2008	BLR, BLY, BVY, BVZ		EPBMPT4-D005Z	93653	17	117

GOLF SPORTSVAN (AM1, AN1)

1.0 TSI	999	85	3	05.2015-	CHZD		EPBBPT4-V002Z	95912	20	300
1.2 TSI	1.197	63	4	05.2014-	CYVA		EPBBPT4-V002Z	95912	20	300
1.2 TSI	1.197	81	4	04.2014-	CYVB		EPBBPT4-V002Z	95912	20	300
1.4 TSI	1.395	92	4	04.2014-	CPVB, CZCA	; Position: Intake Manifold	EPBBPT4-V002Z	95912	20	300
1.4 TSI MultiFuel	1.395	92	4	04.2014-	CPVB		EPBBPT4-V002Z	95912	20	300
1.4 TSI	1.395	110	4	02.2014-	CZDA		EPBBPT4-V002Z	95912	20	300
1.6	1.598	81	4	05.2014-	CWVA		EPBMPT4-V008Z	96201	10	117

JETTA III (1K2)

1.4 TSI	1.390	90	4	05.2007-10.2010	CAXA	; NTC Sensor	EPBBPT4-V003Z	91742	20	254
1.4 TSI	1.390	103	4	07.2006-10.2010	BMY		EPBBPT4-V002Z	95912	20	300
1.4 TSI	1.390	118	4	07.2008-10.2010	CAVD		EPBBPT4-V002Z	95912	20	300
1.4 TSI	1.390	125	4	07.2006-10.2010	BLG		EPBBPT4-V002Z	95912	20	300
1.6	1.595	75	4	09.2004-10.2010	BSE/BSF	; NTC Sensor	EPBMPT4-D005Z	93653	17	117
1.6 FSI	1.598	85	4	09.2005-10.2010	BLF		EPBMPT4-V008Z	96201	10	117



MAP



l kW
C
Y
I



Type-N°

Stock-N°

kPa from

kPa to

VW

JETTA III (1K2)

1.6 TDI	1.598	66	4	12.2009-10.2010	CAYB		EPBBPT4-V002Z	95912	20	300
1.6 TDI	1.598	66	4	12.2009-10.2010	CAYB		EPBBPT4-V003Z	91742	20	254
1.6 TDI	1.598	77	4	06.2009-10.2010	CAYC		EPBBPT4-V003Z	91742	20	254
1.6 TDI	1.598	77	4	07.2009-	CAYC		EPBBPT4-V002Z	95912	20	300
1.9 TDI	1.896	77	4	08.2005-10.2010	BKC, BLS, BXE		EPBBPT4-V003Z	91742	20	254
2.0 TDI	1.968	100	4	09.2005-10.2010	AZV, CBDA		EPBBPT4-V002Z	95912	20	300
2.0 TDI	1.968	103	4	10.2005-10.2010	BMM		EPBBPT4-V002Z	95912	20	300
2.0 TDI 16V	1.968	103	4	08.2005-10.2010	BKD		EPBBPT4-V002Z	95912	20	300
2.0 FSI	1.984	110	4	-06.2008	BLR, BLX, BLY, BVY, BVZ	; NTC Sensor	EPBMPT4-D005Z	93653	17	117
2.0 TDI	1.968	125	4	10.2006-10.2010	BMN, CEGA		EPBBPT4-V002Z	95912	20	300
2.0 TFSI	1.984	147	4	10.2005-10.2010	BWA, CAWB, CCTA		EPBBPT4-V003Z	91742	20	254
2.5	2.480	125	5	-12.2008	CBTA		EPBMPN4-V013Z	93089	10	117
2.5	2.480	125	5	01.2009-	CBTA		EPBMPT4-V008Z	96201	10	117
2.5	2.480	125	5	07.2008-10.2010	CCCA	; Position: Intake Manifold	EPBMPN4-V013Z	93089	10	117

JETTA IV (162, 163, AV3, AV2)

1.4 TSI	1.390	90	4	05.2011-	CAXA, CMSB		EPBBPT4-V003Z	91742	20	254
1.4 TSI	1.395	92	4	08.2014-	CZCA		EPBBPT4-V002Z	95912	20	300
1.4 TSI	1.395	110	4	08.2014-	CZDA, CZTA	; Position: Intake Manifold	EPBBPT4-V002Z	95912	20	300
1.4 TSI	1.390	110	4	04.2011-	CAVA, CTHA	; Position: Intake Manifold; Position: Throttle Housing	EPBBPT4-V002Z	95912	20	300
1.4 TSI Hybrid	1.395	110	4	04.2011-	CNLA, CRJA	; Position: Intake Manifold	EPBBPT4-V002Z	95912	20	300
1.4 TSI	1.390	118	4	04.2011-	CAVD, CTHD	; Position: Intake Manifold; Position: Throttle Housing	EPBBPT4-V002Z	95912	20	300
1.6	1.598	63	4	03.2013-	CFNB		EPBMPT4-V008Z	96201	10	117
1.6 MPi	1.598	66	4	09.2015-04.2018	CWVB		EPBMPT4-V008Z	96201	10	117
1.6	1.598	77	4	12.2011-	CFNA, CLRA		EPBMPT4-V008Z	96201	10	117
1.6 TDI	1.598	77	4	04.2010-07.2014	CAYC		EPBBPT4-V002Z	95912	20	300
1.6	1.598	81	4	09.2015-	CWVA		EPBMPT4-V008Z	96201	10	117
1.8 TSI	1.798	125	4	07.2014-	CPKA, CPRA		EPBBPT4-V002Z	95912	20	300
2.0 TDI	1.968	81	4	10.2010-	CLCA, CUUA		EPBBPT4-V002Z	95912	20	300
2.0	1.984	85	4	06.2010-12.2017	CBPA		EPBMPT4-V008Z	96201	10	117
2.0	1.984	85	4	06.2010-12.2017	CKJA	; Position: Intake Manifold	EPBMPT4-V008Z	96201	10	117
2.0 TDI	1.968	103	4	02.2011-	CFFB, CFHC, CJAA, CLCB		EPBBPT4-V002Z	95912	20	300
2.0 TSI	1.984	155	4	12.2012-12.2017	CPLA, CPPA		EPBBPT4-V002Z	95912	20	300
2.5	2.480	125	5	04.2010-	CBTA, CBUA, CCCA		EPBMPT4-V008Z	96201	10	117

LT II (2DA, 2DB, 2DC, 2DD, 2DE, 2DF, 2DG, 2DH, 2DK, 2DL, 2DM)

2.5 TDI	2.461	61	5	05.2001-07.2006	BBE		EPBBPT4-V003Z	91742	20	254
2.5 TDI	2.461	70	5	05.2001-07.2006	BBF		EPBBPT4-V003Z	91742	20	254



MAP



l kW
C
Y
I



Type-N°

Stock-N°

kPa from
kPa to

VW

LT II (2DA, 2DB, 2DC, 2DD, 2DE, 2DF, 2DG, 2DH, 2DK, 2DL, 2DM)

2.5 TDI	2.461	80	5	05.1999-07.2006	ANJ, AVR		EPBBPT4-V003Z	91742	20	254
2.8 TDI	2.799	116	4	05.2001-07.2006	AUH, BCQ		EPBMBT4-D001Z	91628	11	254

LUPO (6X1, 6E1)

1.0	999	37	4	09.1998-07.2005	ALL, AER		EPBMPT4-D025Z	92358	17	115
1.0	999	37	4	09.1998-07.2005	ALD, ANV, AUC		EPBMPT4-D005Z	93653	17	117
1.0	999	37	4	09.1998-07.2005	AHT		EPBMPT4-V004Z	92899	20	115
1.2 TDI 3L	1.191	45	3	07.1999-07.2005	ANY, AYZ		EPBBPT4-V003Z	91742	20	254
1.4	1.390	44	4	10.2000-07.2005	AUD		EPBMPT4-D005Z	93653	17	117
1.4 16V	1.390	55	4	09.1998-07.2005	AHW, AKQ, APE, AUA, BBY		EPBMPT4-V004Z	92899	20	115
1.4 16V	1.390	74	4	08.1999-07.2005	AFK, ANM, AQQ, AUB		EPBMPT4-V004Z	92899	20	115
1.4 FSI	1.390	77	4	02.2001-07.2005	ARR		EPBMPN4-V040Z	95972	20	115
1.4 TDI	1.422	55	3	01.1999-07.2005	AMF	; Chass. <6X-3-000800	EPBMBT4-D001Z	91628	11	254
1.4 TDI	1.422	55	3	01.1999-07.2005	AMF	; Chass. >6X-3-000801	EPBBPT4-V003Z	91742	20	254
1.6 GTI	1.598	92	4	09.2000-07.2005	AVY		EPBMPT4-V004Z	92899	20	115

MULTIVAN V (7HM, 7HN, 7HF, 7EF, 7EM, 7EN)

1.9 TDI	1.896	62	4	01.2006-11.2009	BRR		EPBBPT4-V003Z	91742	20	254
1.9 TDI	1.896	75	4	06.2006-11.2009	BRS		EPBBPT4-V003Z	91742	20	254
1.9 TDI	1.896	77	4	04.2003-11.2009	AXB (04.03.-)		EPBBPT4-V003Z	91742	20	254
2.0 TDI	1.968	62	4	09.2009-08.2015	CAAA		EPBMPT4-V008Z	96201	10	117
2.0 TDI	1.968	62	4	09.2009-08.2015	CAAA	; NTC Sensor	EPBBPT4-V002Z	95912	20	300
2.0 TDI	1.968	75	4	09.2009-08.2015	CAAB	; Position: Intake Manifold; Chass. >7H-B-000001; Chass. <7H-B-500000	EPBMPT4-V008Z	96201	10	117
2.0 TDI	1.968	75	4	09.2009-08.2015	CAAB	; Chass. >7H-A-200001; Chass. <7H-A-500000; Position: Intake Manifold	EPBMPN4-V013Z	93089	10	117
2.0 TDI	1.968	75	4	09.2009-08.2015	CAAB	; NTC Sensor	EPBBPT4-V002Z	95912	20	300
2.0 TDI	1.968	84	4	05.2011-08.2015	CAAD		EPBMPT4-V008Z	96201	10	117
2.0 TDI	1.968	84	4	05.2011-08.2015	CAAD		EPBBPT4-V002Z	95912	20	300
2.0 TDI	1.968	100	4	05.2010-08.2015	CAAE, CCHB		EPBBPT4-V002Z	95912	20	300
2.0 TDI	1.968	100	4	05.2010-08.2015	CAAE	; Chass. >7H-A-200001; Chass. <7H-A-500000; Position: Intake Manifold	EPBMPN4-V013Z	93089	10	117
2.0 TDI	1.968	100	4	05.2010-08.2015	CCHB	; Position: Intake Manifold; Chass. >7H-A-200001; Chass. <7H-A-500000	EPBMPN4-V013Z	93089	10	117
2.0 TDI	1.968	100	4	05.2010-08.2015	CAAE, CCHB	; Position: Intake Manifold; Chass. >7H-B-000001; Chass. <7H-B-500000	EPBMPT4-V008Z	96201	10	117
2.0 TDI 4motion	1.968	100	4	05.2010-08.2015	CAAE, CCHB		EPBBPT4-V002Z	95912	20	300
2.0 TDI 4motion	1.968	100	4	05.2010-08.2015	CAAE, CCHB	; Chass. >7H-A-200001; Chass. <7H-A-500000; Position: Intake Manifold	EPBMPN4-V013Z	93089	10	117



MAP



l kW
C
Y
I



Type-N°

Stock-N°

kPa from

kPa to

VW

MULTIVAN V (7HM, 7HN, 7HF, 7EF, 7EM, 7EN)

2.0 TDI 4motion	1.968	100	4	05.2010-08.2015	CAAE, CCHB	; Position: Intake Manifold; Chass. >7H-B-000001; Chass. <7H-B-500000	EPBMPT4-V008Z	96201	10	117
2.0 TDI	1.968	103	4	09.2009-08.2015	CAAC, CCHA	; NTC Sensor	EPBBPT4-V002Z	95912	20	300
2.0 TDI	1.968	103	4	09.2009-08.2015	CAAC, CCHA		EPBMPT4-V008Z	96201	10	117
2.0 TDI 4motion	1.968	103	4	09.2009-08.2015	CAAC, CCHA	; NTC Sensor	EPBBPT4-V002Z	95912	20	300
2.0 TDI 4motion	1.968	103	4	09.2009-08.2015	CAAC, CCHA		EPBMPT4-V008Z	96201	10	117
2.0 BiTDI	1.968	132	4	09.2009-08.2015	CFCA	; Position: Intake Manifold; Chass. >7H-B-000001; Chass. <7H-B-500000	EPBMPT4-V008Z	96201	10	117
2.0 BiTDI	1.968	132	4	09.2009-08.2015	CFCA	; Chass. >7H-A-200001; Chass. <7H-A-500000; Position: Intake Manifold	EPBMPN4-V013Z	93089	10	117
2.0 BiTDI 4motion	1.968	132	4	09.2009-08.2015	CFCA	; Position: Intake Manifold; Chass. >7H-B-000001; Chass. <7H-B-500000	EPBMPT4-V008Z	96201	10	117
2.0 BiTDI 4motion	1.968	132	4	09.2009-08.2015	CFCA	; Chass. >7H-A-200001; Chass. <7H-A-500000; Position: Intake Manifold	EPBMPN4-V013Z	93089	10	117
2.5 TDI	2.461	96	5	04.2003-11.2009	AXD, BNZ		EPBBPT4-V002Z	95912	20	300
2.5 TDI 4motion	2.461	96	5	07.2004-11.2009	AXD, BNZ		EPBBPT4-V002Z	95912	20	300
2.5 TDI	2.461	120	5	11.2003-11.2009	BLJ		EPBBPT4-V002Z	95912	20	300
2.5 TDI	2.461	128	5	04.2003-11.2009	AXE (04.03-), BPC		EPBBPT4-V002Z	95912	20	300
2.5 TDI 4motion	2.461	128	5	07.2004-11.2009	AXE, BPC		EPBBPT4-V002Z	95912	20	300

NEW BEETLE (9C1, 1C1, 1Y7)

1.4	1.390	55	4	11.2001-09.2010	BCA		EPBMPT4-D005Z	93653	17	117
1.9 TDI	1.896	74	4	02.2001-09.2010	ATD, AXR, BEW		EPBBPT4-V003Z	91742	20	254
1.9 TDI	1.896	77	4	07.2005-09.2010	BSW		EPBBPT4-V003Z	91742	20	254
2.0	1.984	85	4	09.2002-10.2010	BDC		EPBMBT4-D001Z	91628	11	254
2.5	2.480	110	5	-06.2008	BPR, BPS	; Chass. <1Y8499000	EPBMPN4-V013Z	93089	10	117
2.5	2.480	110	5	07.2008-	BPR, BPS	; Chass. >1Y9400001	EPBMPT4-V008Z	96201	10	117

PASSAT B3/B4 (35I, 315, 3A2, 3A5)

1.9 TDI	1.896	66	4	10.1993-05.1997	1Z		EPBMPN3-A027Z	90915	20	105
---------	-------	----	---	-----------------	----	--	---------------	-------	----	-----

PASSAT B5 (3B2, 3B3, 3B5, 3B6)

1.6	1.595	75	4	11.2000-05.2005	ALZ		EPBMPN4-D019Z	91102	16,9	116,9
1.8 T 20V	1.781	110	4	11.2000-05.2005	AWT	; Chass. <3B-3-350000	EPBMBT4-D001Z	91628	11	254
1.8 T 20V	1.781	110	4	11.2000-05.2005	AWT	; Chass. >3B-3-350001	EPBBPN4-V014Z	93428	20	250
1.8 T 20V	1.781	110	4	11.2000-05.2005	AWT		EPBMPN4-D019Z	91102	16,9	116,9
1.8 T	1.781	125	4	02.2001-08.2005	AWM	; Chass. <3B-3-350000	EPBMBT4-D001Z	91628	11	254
1.8 T	1.781	125	4	02.2001-08.2005	AWM	; Chass. >3B-3-350001	EPBBPN4-V014Z	93428	20	250
1.8 T 4motion	1.781	125	4	03.2001-05.2005	AWM	; Chass. <3B-3-350000	EPBMBT4-D001Z	91628	11	254
1.8 T 4motion	1.781	125	4	03.2001-05.2005	AWM	; Chass. >3B-3-350001	EPBBPN4-V014Z	93428	20	250



MAP



l kW
C
Y
I



Type-N°

Stock-N°

kPa from
kPa to

VW

PASSAT B5 (3B2, 3B3, 3B5, 3B6)

1.9 TDI	1.896	66	4	06.1997-11.2000	AHU, AHH	; With Charger Intercooler; Chass. >3B-W-040001	EPBMBT4-D001Z	91628	11	254
1.9 TDI	1.896	74	4	11.2000-05.2005	AVB		EPBBPT4-V003Z	91742	20	254
1.9 TDI	1.896	74	4	11.2000-05.2005	AVB		EPBMPN4-D019Z	91102	16,9	116,9
1.9 TDI	1.896	96	4	11.2000-05.2005	AVF, AWX		EPBBPT4-V002Z	95912	20	300
1.9 TDI	1.896	96	4	11.2000-05.2005	AVF, AWX		EPBMPN4-D019Z	91102	16,9	116,9
1.9 TDI 4motion	1.896	96	4	11.2000-05.2005	AVF		EPBBPT4-V002Z	95912	20	300
1.9 TDI 4motion	1.896	96	4	11.2000-05.2005	AVF		EPBMPN4-D019Z	91102	16,9	116,9
2.0	1.984	85	4	11.2000-05.2005	AZM		EPBMPN4-D019Z	91102	16,9	116,9
2.0 4motion	1.984	85	4	11.2000-05.2005	AZM		EPBMPN4-D019Z	91102	16,9	116,9
2.0	1.984	96	4	11.2001-05.2005	ALT		EPBMPN4-D019Z	91102	16,9	116,9
2.0 TDI	1.968	100	4	12.2003-05.2005	BGW, BHW		EPBBPT4-V002Z	95912	20	300
2.0 TDI	1.968	100	4	12.2003-05.2005	BGW		EPBMPN4-D019Z	91102	16,9	116,9
2.3 V5	2.324	125	5	11.2000-05.2005	AZX		EPBMPN4-D019Z	91102	16,9	116,9
2.3 V5 4motion	2.324	125	5	11.2000-05.2005	AZX		EPBMPN4-D019Z	91102	16,9	116,9
2.5 TDI	2.496	110	6	-05.2003	AKN		EPBMPN4-D019Z	91102	16,9	116,9
2.5 TDI	2.496	110	6	11.2000-05.2005	AKN		EPBMBT4-D001Z	91628	11	254
2.5 TDI 4motion	2.496	110	6	-01.2003	AKN		EPBMPN4-D019Z	91102	16,9	116,9
2.5 TDI 4motion	2.496	110	6	11.2000-05.2005	AKN		EPBMBT4-D001Z	91628	11	254
2.5 TDI	2.496	120	6	05.2003-05.2005	BDG		EPBBPT4-V003Z	91742	20	254
2.5 TDI	2.496	120	6	05.2003-05.2005	BDG		EPBMPN4-D019Z	91102	16,9	116,9
2.5 TDI 4motion	2.496	132	6	01.2003-05.2005	BAU, BDH		EPBBPT4-V003Z	91742	20	254
2.5 TDI 4motion	2.496	132	6	01.2003-05.2005	BAU, BDH		EPBMPN4-D019Z	91102	16,9	116,9
2.8 4motion	2.771	142	6	11.2000-05.2005	AMX, ATQ		EPBMPN4-D019Z	91102	16,9	116,9
4.0 W8 4motion	3.999	202	8	09.2001-09.2004	BDN, BDP		EPBMPN4-D019Z	91102	16,9	116,9

PASSAT B6 (3C2, 3C5)

1.4 TSI	1.390	90	4	05.2007-11.2010	CAXA		EPBBPT4-V003Z	91742	20	254
1.4 TSI EcoFuel	1.390	110	4	01.2009-11.2010	CDGA		EPBBPT4-V002Z	95912	20	300
1.6	1.595	75	4	05.2005-11.2010	BSE, BSF		EPBMPT4-D005Z	93653	17	117
1.6 TDI	1.598	77	4	08.2009-11.2010	CAYC		EPBBPT4-V002Z	95912	20	300
1.6 FSI	1.598	85	4	03.2005-06.2008	BLF		EPBMPT4-V008Z	96201	10	117
1.8 TSI	1.798	112	4	11.2009-11.2010	CDAB, CGYA		EPBBPN4-V014Z	93428	20	250
1.8 TSI	1.798	118	4	05.2007-10.2011	BZB, CDA		EPBBPN4-V014Z	93428	20	250
1.9 TDI	1.896	77	4	03.2005-11.2010	BKC, BLS, BXE		EPBBPT4-V003Z	91742	20	254
2.0 TDI	1.968	81	4	11.2008-11.2010	CBDC		EPBBPT4-V002Z	95912	20	300
2.0 TDI	1.968	88	4	11.2005-05.2007	BWV		EPBBPT4-V002Z	95912	20	300
2.0 TDI	1.968	90	4	08.2005-07.2006	BVE		EPBBPT4-V002Z	95912	20	300



MAP



l kW
C
Y
I



Type-N°

Stock-N°

kPa from

kPa to

VW

PASSAT B6 (3C2, 3C5)

2.0 TDI	1.968	100	4	03.2005-11.2010	BMA, CBAA		EPBBPT4-V002Z	95912	20	300
2.0 TDI	1.968	100	4	08.2005-11.2010	BMA, CBAA		EPBBPT4-V002Z	95912	20	300
2.0 TDI	1.968	103	4	03.2005-05.2009	BMP		EPBBPT4-V002Z	95912	20	300
2.0 TDI 4motion	1.968	103	4	03.2005-05.2009	BMP	; NTC Sensor	EPBBPT4-V002Z	95912	20	300
2.0 TDI 16V	1.968	103	4	03.2005-11.2010	BKP, CBAB		EPBBPT4-V002Z	95912	20	300
2.0 TDI 16V 4motion	1.968	103	4	03.2005-11.2010	BKP, CBAB	; NTC Sensor	EPBBPT4-V002Z	95912	20	300
2.0 BlueTDI	1.968	105	4	01.2009-11.2010	CBAC		EPBBPT4-V002Z	95912	20	300
2.0 FSI	1.984	110	4	03.2005-11.2010	BLR, BLY, BVY, BVZ		EPBMPT4-D005Z	93653	17	117
2.0 FSI 4motion	1.984	110	4	09.2005-11.2010	BLX, BLY, BVX	; NTC Sensor	EPBMPT4-D005Z	93653	17	117
2.0 TDI	1.968	120	4	08.2005-05.2009	BUZ		EPBBPT4-V002Z	95912	20	300
2.0 FSI	1.984	125	4	08.2007-07.2010	CCTB		EPBBPN4-V014Z	93428	20	250
2.0 TDI	1.968	125	4	08.2005-11.2010	BMR, CBBB		EPBBPT4-V002Z	95912	20	300
2.0 TDI 4motion	1.968	125	4	05.2009-11.2010	CBBB		EPBBPT4-V002Z	95912	20	300
2.0 FSI	1.984	147	4	07.2005-11.2010	AXX, BWA, BPY, CAWB, CCTA, CBFA, CCZA		EPBBPN4-V014Z	93428	20	250

PASSAT B7 (362, 365)

1.4 TSI	1.390	90	4	08.2010-12.2014	CAXA		EPBBPT4-V003Z	91742	20	254
1.4 TSI EcoFuel	1.390	110	4	08.2010-12.2014	CDGA	; Position: Intake Manifold; Position: Throttle Housing	EPBBPT4-V002Z	95912	20	300
1.4 TSI	1.390	118	4	11.2012-12.2014	CTHD	; Position: Intake Manifold; Position: Throttle Housing	EPBBPT4-V002Z	95912	20	300
1.4 TSI MultiFuel	1.390	118	4	11.2010-12.2014	CKMA	; Position: Intake Manifold; Position: Throttle Housing	EPBBPT4-V002Z	95912	20	300
1.6 TDI	1.598	77	4	08.2010-12.2014	CAYC		EPBBPT4-V002Z	95912	20	300
2.0 TDI	1.968	100	4	08.2010-12.2014	CFFA		EPBBPT4-V002Z	95912	20	300
2.0 TDI	1.968	103	4	08.2010-12.2014	CFFB		EPBBPT4-V002Z	95912	20	300
2.0 TDI 4motion	1.968	103	4	08.2010-12.2014	CFFB		EPBBPT4-V002Z	95912	20	300
2.0 TDI Alltrack	1.968	103	4	01.2012-12.2014	CFFB		EPBBPT4-V002Z	95912	20	300
2.0 TDI 4motion Alltrack	1.968	103	4	01.2012-12.2014	CFFB		EPBBPT4-V002Z	95912	20	300
2.0 TDI	1.968	125	4	08.2010-12.2014	CFGB, CLLA		EPBBPT4-V002Z	95912	20	300
2.0 TDI 4motion	1.968	125	4	08.2010-01.2013	CFGB		EPBBPT4-V002Z	95912	20	300
2.0 TDI 4motion Alltrack	1.968	125	4	01.2012-12.2014	CFGB		EPBBPT4-V002Z	95912	20	300
2.0 TDI	1.968	130	4	12.2012-12.2014	CFGC		EPBBPT4-V002Z	95912	20	300
2.0 TDI 4motion	1.968	130	4	01.2013-12.2014	CFGC		EPBBPT4-V002Z	95912	20	300
2.0 TDI 4motion Alltrack	1.968	130	4	01.2013-12.2014	CFGC		EPBBPT4-V002Z	95912	20	300
2.0 TSI	1.984	155	4	11.2010-12.2014	CCZB		EPBBPN4-V014Z	93428	20	250
2.0 TSI 4motion Alltrack	1.984	155	4	01.2012-12.2014	CCZB		EPBBPN4-V014Z	93428	20	250

PASSAT B8 (3G2, 3G5, CB2, CB5)

1.4 TSI	1.395	92	4	11.2014-	CZCA		EPBBPT4-V002Z	95912	20	300
---------	-------	----	---	----------	------	--	---------------	-------	----	-----



MAP



l kW
C
Y
I



Type-N°

Stock-N°

kPa from
kPa to

VW

PASSAT B8 (3G2, 3G5, CB2, CB5)

1.4 GTE Hybrid	1.395	115	4	06.2015-	CUKC		EPBBPT4-V002Z	95912	20	300
1.4 TSI	1.395	110	4	11.2014-	CZEA, CZDA		EPBBPT4-V002Z	95912	20	300
1.4 TSI 4motion	1.395	110	4	02.2015-	CZEA		EPBBPT4-V002Z	95912	20	300
1.4 TSI 4motion Alltrack	1.395	110	4	05.2015-	CZEA		EPBBPT4-V002Z	95912	20	300
1.8 TSI	1.798	132	4	02.2015-	CJSA, CJSC		EPBBPT4-V002Z	95912	20	300
2.0 TSI	1.984	162	4	08.2014-	CHHB, CXDA		EPBBPT4-V002Z	95912	20	300
2.0 TSI 4motion Alltrack	1.984	162	4	07.2015-	CHHB		EPBBPT4-V002Z	95912	20	300
2.0 TSI 4motion	1.984	206	4	05.2015-	CJXA		EPBBPT4-V002Z	95912	20	300

PASSAT CC (357)

1.4 TSI MultiFuel	1.390	118	4	01.2011-01.2012	CKMA		EPBBPT4-V002Z	95912	20	300
2.0 TDI	1.968	100	4	06.2008-05.2011	CBAA, CFFA		EPBBPT4-V002Z	95912	20	300
2.0 TDI	1.968	103	4	06.2008-01.2012	CBAB, CFFB		EPBBPT4-V002Z	95912	20	300
2.0 TDI 4motion	1.968	103	4	08.2009-01.2012	CBAB, CFFB		EPBBPT4-V002Z	95912	20	300
2.0 BlueTDI	1.968	105	4	05.2009-11.2010	CBAC		EPBBPT4-V002Z	95912	20	300
2.0 TDI	1.968	125	4	06.2008-01.2012	CBBB, CFGB, CLLA		EPBBPT4-V002Z	95912	20	300
2.0 TDI 4motion	1.968	125	4	11.2009-01.2012	CBBB, CFGB		EPBBPT4-V002Z	95912	20	300

PHAETON (3D_)

3.0 V6 TDI 4motion	2.967	165	6	09.2004-05.2007	BMK		EPBBPT4-V002Z	95912	20	300
3.0 V6 TDI 4motion	2.967	171	6	06.2007-11.2008	CARA		EPBBPT4-V002Z	95912	20	300
3.0 V6 TDI 4motion	2.967	176	6	11.2008-03.2016	CARB, CEXA		EPBBPT4-V002Z	95912	20	300
3.0 V6 TDI 4motion	2.967	180	6	11.2013-03.2016	CEXB		EPBBPT4-V002Z	95912	20	300
5.0 V10 TDI 4motion	4.921	230	10	11.2002-10.2006	AJS		EPBBPT4-V002Z	95912	20	300

POLO III (6N1, 6N2)

50 1.0	999	37	4	09.1996-10.1999	AER, ALL		EPBMPT4-D025Z	92358	17	115
1.0	999	37	4	10.1999-09.2001	ALD, AUC		EPBMPT4-D005Z	93653	17	117
55 1.4	1.390	40	4	08.1995-10.1999	AEX		EPBMPT4-D025Z	92358	17	115
1.4	1.390	40	4	10.1999-09.2001	AKP, ANX		EPBMPT4-D005Z	93653	17	117
60 1.4	1.390	44	4	07.1995-10.1999	AEX, AKV, APQ		EPBMPT4-D025Z	92358	17	115
1.4	1.390	44	4	10.1999-09.2001	AKK, AUD		EPBMPT4-D005Z	93653	17	117
1.4 16V	1.390	55	4	10.1999-09.2001	AHW, APE, AUA		EPBMPT4-V004Z	92899	20	115
100 1.4 16V	1.390	74	4	04.1996-10.1999	AFH		EPBMPT4-V004Z	92899	20	115
1.4 16V	1.390	74	4	10.1999-09.2001	AFK, AQQ, AUB		EPBMPT4-V004Z	92899	20	115
75 1.6	1.598	55	4	10.1994-10.1999	AEA, AEE, AHS		EPBMPT4-V004Z	92899	20	115
120 1.6 16V GTI	1.598	88	4	09.1998-10.1999	AJV		EPBMPT4-V004Z	92899	20	115
1.6 16V GTI	1.598	92	4	10.1999-09.2001	ARC, AVY		EPBMPT4-V004Z	92899	20	115

POLO III CLASSIC / VARIANT (6V2, 6V5)

1.4	1.390	40	4	12.1998-09.2001	AKP		EPBMPT4-D005Z	93653	17	117
-----	-------	----	---	-----------------	-----	--	---------------	-------	----	-----



MAP



l kW
C
Y
I



Type-N°

Stock-N°

kPa from

kPa to

VW

POLO III CLASSIC / VARIANT (6V2, 6V5)

60 1.4	1.390	44	4	12.1995-09.2001	AEX, AKV, APQ		EPBMPT4-D025Z	92358	17	115
60 1.4	1.390	44	4	12.1995-09.2001	AKK, ANW, AUD		EPBMPT4-D005Z	93653	17	117
75 1.6	1.598	55	4	11.1995-09.2001	AEE, ALM		EPBMPT4-V004Z	92899	20	115
75 1.4 16V	1.390	55	4	10.1999-09.2001	APE, AUA		EPBMPT4-V004Z	92899	20	115
90 1.9 TDI	1.896	66	4	09.1996-09.2001	AGR, ALH		EPBMBT4-D001Z	91628	11	254
110 1.9 TDI	1.896	81	4	06.1998-01.2002	ASV		EPBMBT4-D001Z	91628	11	254

POLO IV (9N_)

1.2	1.198	40	3	01.2002-05.2007	AWY, BMD		EPBMPT4-V011Z	91119	20	115
1.2	1.198	44	3	05.2007-11.2009	BBM		EPBMPT4-V011Z	91119	20	115
1.2 12V	1.198	47	3	10.2001-07.2007	AZQ, BME		EPBMPT4-D005Z	93653	17	117
1.2 12V	1.198	51	3	05.2007-11.2009	BZG		EPBMPT4-D005Z	93653	17	117
1.4 TDI	1.422	51	3	04.2005-11.2009	BNM, BWB		EPBBPT4-V003Z	91742	20	254
1.4 16V	1.390	55	4	06.2003-	AUA, BKY	; Chass. >9N4000001	EPBMPT4-V008Z	96201	10	117
1.4 16V	1.390	55	4	10.2001-05.2008	AUA, BBY, BKY	; NTC Sensor	EPBMPT4-V004Z	92899	20	115
1.4 TDI	1.422	55	3	10.2001-06.2005	AMF, BAY		EPBMBT4-D001Z	91628	11	254
1.4 TDI	1.422	55	3	10.2001-06.2005	AMF, BAY		EPBBPT4-V003Z	91742	20	254
1.4 16V	1.390	59	4	05.2006-11.2009	BUD		EPBMPT4-V008Z	96201	10	117
1.4 TDI	1.422	59	3	04.2005-11.2009	BMS, BNV		EPBBPT4-V003Z	91742	20	254
1.4 BiFuel	1.390	60	4	05.2006-11.2009	BUD		EPBMPT4-V008Z	96201	10	117
1.4	1.390	61	4	08.2002-11.2009	BLM		EPBMPT4-V008Z	96201	10	117
1.4 FSI	1.390	63	4	02.2002-07.2006	AXU		EPBMPT4-V008Z	96201	10	117
1.4 16V	1.390	74	4	10.2001-05.2008	AUB, BBZ		EPBMPT4-V004Z	92899	20	115
1.6 16V	1.598	77	4	05.2006-11.2009	BTS		EPBMPT4-V008Z	96201	10	117
1.8 GTI	1.781	110	4	09.2005-11.2009	BJX		EPBBPT4-V003Z	91742	20	254
1.8 GTI Cup Edition	1.781	132	4	05.2006-11.2009	BBU		EPBBPT4-V003Z	91742	20	254
1.9 TDI	1.896	74	4	10.2001-11.2009	ATD, AXR		EPBMBT4-D001Z	91628	11	254
1.9 TDI	1.896	74	4	10.2001-11.2009	BMT		EPBBPT4-V003Z	91742	20	254
1.9 TDI	1.896	96	4	11.2003-11.2009	ASZ, BLT		EPBBPT4-V002Z	95912	20	300

POLO IV SALOON (602, 604, 612, 614)

1.4	1.390	55	4	11.2002-04.2012	BKY		EPBMPT4-V008Z	96201	10	117
1.4	1.390	55	4	11.2002-04.2012	BBY, BKY	; NTC Sensor	EPBMPT4-V004Z	92899	20	115
1.4 TDI	1.422	55	3	07.2003-	BAY		EPBMBT4-D001Z	91628	11	254
1.4 TDI	1.422	55	3	07.2003-	BAY		EPBBPT4-V003Z	91742	20	254
1.4	1.390	61	4	12.2003-08.2010	BLM		EPBMPT4-V008Z	96201	10	117
1.4	1.390	74	4	11.2003-	BBZ		EPBBPT4-V003Z	91742	20	254
1.4	1.390	74	4	11.2003-	BBZ		EPBMPT4-V004Z	92899	20	115
1.6	1.598	63	4	11.2010-	CFNB		EPBMPT4-V008Z	96201	10	117



MAP



l kW
C
Y
I



Type-N°

Stock-N°

kPa from
kPa to

VW

POLO IV SALOON (602, 604, 612, 614)

1.6	1.598	66	4	07.2014-	CWVB		EPBMPT4-V008Z	96201	10	117
1.6 Total Flex	1.598	74	4	10.2004-	BPA		EPBMPT4-V008Z	96201	10	117
1.6 Flex	1.598	76	4	12.2004-04.2008	BPA		EPBMPT4-V008Z	96201	10	117
1.6	1.598	77	4	05.2010-	CFNA		EPBMPT4-V008Z	96201	10	117
1.6	1.598	77	4	05.2010-	CLSA	; Position: Intake Manifold	EPBMPT4-V008Z	96201	10	117
1.6	1.598	81	4	05.2015-	CWVA		EPBMPT4-V008Z	96201	10	117
1.9 TDi	1.896	74	4	09.2002-	ATD		EPBMBT4-D001Z	91628	11	254

POLO V (6R1, 6C1, 6R)

1.0	999	44	3	01.2014-	CHYA		EPBMPT4-V008Z	96201	10	117
1.0	999	55	3	01.2014-	CHYB		EPBMPT4-V008Z	96201	10	117
1.0 TSI	999	70	3	11.2014-	CHZB		EPBBPT4-V002Z	95912	20	300
1.0 TSI	999	81	3	11.2014-	CHZC		EPBMPT4-V008Z	96201	10	117
1.0 TSI	999	81	3	11.2014-	CHZC		EPBBPT4-V002Z	95912	20	300
1.0 TSI	999	81	3	11.2014-	CHZC		EPBMPN4-V040Z	95972	20	115
1.2	1.198	44	3	06.2009-	CGPB		EPBMPT4-D005Z	93653	17	117
1.2	1.198	44	3	11.2010-	CGPB		EPBMPT4-V008Z	96201	10	117
1.2	1.198	51	3	06.2009-	CGPA		EPBMPT4-D005Z	93653	17	117
1.2	1.198	51	3	11.2010-	CGPA		EPBMPT4-V008Z	96201	10	117
1.2 TDI	1.199	55	3	-09.2010	CFWA	; NTC Sensor	EPBBPT4-V002Z	95912	20	300
1.2 TSI 16V	1.197	66	4	02.2014-	CJZC		EPBBPT4-V002Z	95912	20	300
1.2 TSI	1.197	81	4	01.2014-	CJZD		EPBBPT4-V002Z	95912	20	300
1.4 BiFuel	1.390	60	4	03.2010-01.2011	CMAA		EPBMPT4-V008Z	96201	10	117
1.4	1.390	63	4	03.2009-05.2014	CGGB, CLPA		EPBMPT4-V008Z	96201	10	117
1.4 TSI	1.395	103	4	10.2012-	CPTA	; Position: Intake Manifold	EPBBPT4-V002Z	95912	20	300
1.4 TSI	1.395	110	4	05.2014-	CZEA		EPBBPT4-V002Z	95912	20	300
1.4 GTI	1.390	132	4	05.2010-	CAVE, CTHE		EPBBPT4-V002Z	95912	20	300
1.6 TDI	1.598	55	4	06.2009-	CAYA		EPBBPT4-V002Z	95912	20	300
1.6 BiFuel	1.598	60	4	01.2011-	CNKA		EPBMPT4-V008Z	96201	10	117
1.6	1.598	66	4	07.2014-	CWVB		EPBMPT4-V008Z	96201	10	117
1.6 TDI	1.598	66	4	06.2009-	CAYB		EPBBPT4-V002Z	95912	20	300
1.6	1.598	77	4	01.2010-	CFNA, CLSA	; Position: Intake Manifold	EPBMPT4-V008Z	96201	10	117
1.6 TDI	1.598	77	4	06.2009-	CAYC, CLNA		EPBBPT4-V002Z	95912	20	300
1.6	1.598	81	4	07.2014-	CWVA		EPBMPT4-V008Z	96201	10	117
1.8 GTI	1.798	141	4	11.2014-	DAJA, DAJB		EPBBPT4-V002Z	95912	20	300
2.0 R WRC	1.984	162	4	08.2013-	CDLJ		EPBBPT4-V002Z	95912	20	300

POLO VI (AW1, BZ1)

1.0	999	48	3	08.2017-	CHYC, DFNB		EPBMPT4-V008Z	96201	10	117
-----	-----	----	---	----------	------------	--	---------------	-------	----	-----



MAP



C
Y
I



Type-N°

Stock-N°

kPa from

kPa to

VW

POLO VI (AW1, BZ1)

1.0	999	55	3	06.2017-	CHYB		EPBBPT4-V008Z	96201	10	117
-----	-----	----	---	----------	------	--	---------------	-------	----	-----

SCIROCCO (137, 138)

1.4 TSI	1.390	90	4	08.2008-11.2017	CAXA, CMSB	; NTC Sensor	EPBBPT4-V003Z	91742	20	254
1.4 TSI	1.395	92	4	11.2013-11.2017	CZCA	; Position: Intake Manifold	EPBBPT4-V002Z	95912	20	300
1.4 TSI	1.395	110	4	07.2015-11.2017	CZDA		EPBBPT4-V002Z	95912	20	300
1.4 TSI	1.390	118	4	05.2008-11.2017	CAVD, CNWA, CTHD, CTKA	; NTC Sensor	EPBBPT4-V002Z	95912	20	300
2.0 TDI	1.968	100	4	11.2010-11.2017	CFHB		EPBBPT4-V002Z	95912	20	300
2.0 TDI	1.968	103	4	08.2008-11.2017	CBDB, CFHC	; NTC Sensor	EPBBPT4-V002Z	95912	20	300
2.0 TDI	1.968	125	4	05.2009-11.2017	CBBB, CFGB	; NTC Sensor	EPBBPT4-V002Z	95912	20	300
2.0 TDI	1.968	130	4	01.2013-11.2017	CFGC		EPBBPT4-V002Z	95912	20	300
2.0 TSI	1.984	132	4	11.2013-11.2017	CULA		EPBBPT4-V002Z	95912	20	300
2.0 TSI	1.984	162	4	11.2013-11.2017	CULC		EPBBPT4-V002Z	95912	20	300
2.0 R	1.984	188	4	11.2009-11.2017	CDLC		EPBBPT4-V002Z	95912	20	300
2.0 R	1.984	195	4	11.2009-11.2017	CDLA	; NTC Sensor	EPBBPT4-V002Z	95912	20	300
2.0 R	1.984	206	4	05.2014-11.2017	CDLK		EPBBPT4-V002Z	95912	20	300

SHARAN (7M8, 7M9, 7M6)

1.8 T 20V	1.781	110	4	09.1997-03.2010	AJH, AWC		EPBBPT4-V003Z	91742	20	254
1.9 TDI	1.896	66	4	09.1995-03.2010	1Z, AHU, ANU		EPBBPT4-V003Z	91742	20	254
1.9 TDI	1.896	85	4	04.2000-03.2010	AUY, BVK		EPBBPT4-V003Z	91742	20	254
1.9 TDI 4motion	1.896	85	4	04.2000-03.2010	AUY		EPBBPT4-V003Z	91742	20	254
1.9 TDI	1.896	96	4	11.2002-03.2010	ASZ		EPBBPT4-V002Z	95912	20	300
1.9 TDI	1.896	110	4	06.2005-03.2010	BTB		EPBBPT4-V002Z	95912	20	300
2.0 TDI	1.968	100	4	11.2005-03.2010	BVH		EPBBPT4-V002Z	95912	20	300
2.0 TDI	1.968	103	4	11.2005-03.2010	BRT		EPBBPT4-V002Z	95912	20	300

SHARAN (7N1, 7N2)

1.4 TSI	1.390	110	4	05.2010-	CAVA, CNWB, CTHA		EPBBPT4-V002Z	95912	20	300
1.4 TSI	1.395	110	4	05.2015-	CZDA		EPBBPT4-V002Z	95912	20	300
2.0 TDI	1.968	85	4	05.2011-07.2019	CFFE, CUVA, DFLD, DLTC		EPBBPT4-V002Z	95912	20	300
2.0 TDI	1.968	100	4	05.2010-	CFFA		EPBBPT4-V002Z	95912	20	300
2.0 TDI	1.968	103	4	05.2010-	CFFB		EPBBPT4-V002Z	95912	20	300
2.0 TDI 4motion	1.968	103	4	05.2011-	CFFB		EPBBPT4-V002Z	95912	20	300
2.0 TDI	1.968	125	4	08.2010-	CFGB		EPBBPT4-V002Z	95912	20	300
2.0 TDI	1.968	130	4	01.2013-	CFGC, DLUB		EPBBPT4-V002Z	95912	20	300
2.0 TSI	1.984	162	4	05.2015-	DEDA		EPBBPT4-V002Z	95912	20	300

TIGUAN (5N_)

1.4 TSI	1.390	90	4	08.2010-07.2018	CAXA		EPBBPT4-V003Z	91742	20	254
1.4 TSI	1.395	92	4	05.2015-07.2018	CZDB	; Position: Intake Manifold	EPBBPT4-V002Z	95912	20	300



MAP



l kW
C
Y
I



Type-N°

Stock-N°

kPa from
kPa to

VW

TIGUAN (5N_)

1.4 TSI	1.390	110	4	05.2008-07.2018	CAVA, CTHA	; NTC Sensor	EPBBPT4-V002Z	95912	20	300
1.4 TSI	1.395	110	4	05.2015-07.2018	CZDA	; Position: Intake Manifold	EPBBPT4-V002Z	95912	20	300
1.4 TSI 4motion	1.390	110	4	09.2007-07.2018	BWK, CAVA, CTHA	; NTC Sensor	EPBBPT4-V002Z	95912	20	300
1.4 TSI	1.390	118	4	05.2011-07.2018	CAVD, CTHD	; Position: Intake Manifold; Position: Throttle Housing	EPBBPT4-V002Z	95912	20	300
1.4 TSI 4motion	1.390	118	4	05.2011-07.2018	CAVD, CTHD	; Position: Intake Manifold; Position: Throttle Housing	EPBBPT4-V002Z	95912	20	300
2.0 TDI	1.968	81	4	05.2010-07.2018	CFFD, CUVE		EPBBPT4-V002Z	95912	20	300
2.0 TDI 4motion	1.968	100	4	11.2007-07.2018	CBAA, CFFA	; NTC Sensor	EPBBPT4-V002Z	95912	20	300
2.0 TDI	1.968	103	4	03.2008-07.2018	CBAB, CFFB	; NTC Sensor	EPBBPT4-V002Z	95912	20	300
2.0 TDI 4motion	1.968	103	4	09.2007-07.2018	CBAB, CFFB, CLJA	; NTC Sensor	EPBBPT4-V002Z	95912	20	300
2.0 TDI 4motion	1.968	120	4	02.2008-08.2009	CBBA		EPBBPT4-V002Z	95912	20	300
2.0 TDI 4motion	1.968	125	4	09.2007-07.2018	CBBB, CFGB	; NTC Sensor	EPBBPT4-V002Z	95912	20	300
2.0 TDI 4motion	1.968	130	4	11.2012-07.2018	CFGC		EPBBPT4-V002Z	95912	20	300

TIGUAN (AD1)

1.4 TSI	1.395	92	4	01.2016-	CZCA		EPBBPT4-V002Z	95912	20	300
1.4 TSI	1.395	110	4	01.2016-	CZEA, CZDA		EPBBPT4-V002Z	95912	20	300
1.4 TSI 4motion	1.395	110	4	05.2016-	CZEA, CZDA		EPBBPT4-V002Z	95912	20	300
2.0 TSI 4motion	1.984	132	4	01.2016-	CZPA		EPBBPT4-V002Z	95912	20	300
2.0 TSI 4motion	1.984	162	4	06.2016-	CHHB		EPBBPT4-V002Z	95912	20	300

TOUAREG (7LA, 7L6, 7L7)

2.5 R5 TDI	2.461	120	5	08.2003-05.2010	BLK, BPD		EPBBPT4-V002Z	95912	20	300
2.5 R5 TDI	2.461	128	5	01.2003-05.2010	BAC, BPE		EPBBPT4-V002Z	95912	20	300
3.0 TDI	2.967	155	6	04.2006-05.2010	BUN, CASB		EPBBPT4-V002Z	95912	20	300
3.0 V6 TDI	2.967	165	6	11.2004-05.2010	BKS, CATA		EPBBPT4-V002Z	95912	20	300
3.0 V6 TDI	2.967	176	6	11.2007-05.2010	CASA, CASC		EPBBPT4-V002Z	95912	20	300
5.0 V10 TDI	4.921	230	10	10.2002-05.2010	AYH, BKW, BLE, BWF		EPBBPT4-V002Z	95912	20	300
5.0 R50 TDI	4.921	257	10	08.2007-05.2010	CBWA		EPBBPT4-V002Z	95912	20	300

TOUAREG (7P5, 7P6)

3.0 V6 TDI	2.967	150	6	01.2010-03.2018	CASD, CJMA, CRCD, CVWA		EPBBPT4-V002Z	95912	20	300
3.0 V6 TDI	2.967	165	6	06.2010-03.2018	CATA		EPBBPT4-V002Z	95912	20	300
3.0 V6 TDI	2.967	176	6	01.2010-03.2018	CASA, CNRB		EPBBPT4-V002Z	95912	20	300
3.0 V6 TDI	2.967	180	6	05.2011-03.2018	CJGD, CRCA		EPBBPT4-V002Z	95912	20	300
3.0 V6 TDI	2.967	193	6	09.2014-03.2018	CVWA		EPBBPT4-V002Z	95912	20	300
3.0 V6 TSI Hybrid	2.995	245	6	04.2010-03.2018	CGFA, CGEA	;	EPBMPT4-V008Z	96201	10	117
4.2 V8 TDI	4.134	250	8	01.2010-03.2018	CKDA		EPBBPT4-V002Z	95912	20	300
4.2 V8 FSI	4.163	265	8	01.2011-03.2018	CGNA	; Position: Intake Manifold	EPBMPT4-V008Z	96201	10	117



MAP



l kW
C
Y
I



Type-N°

Stock-N°

kPa from

kPa to

VW

TOURAN (1T1, 1T2)

1.4 TSI	1.390	103	4	02.2006-05.2010	BMV, CAVC		EPBBPT4-V002Z	95912	20	300
1.4 TSI EcoFuel	1.390	110	4	05.2009-05.2010	CDGA		EPBBPT4-V002Z	95912	20	300
1.4 FSI	1.390	125	4	11.2006-05.2010	BLG, CAVB		EPBBPT4-V002Z	95912	20	300
1.6	1.595	75	4	07.2003-05.2010	BGU, BSE, BSF		EPBMPT4-D005Z	93653	17	117
1.6 FSI	1.598	85	4	02.2003-01.2007	BAG, BLF, BLP		EPBMPT4-V008Z	96201	10	117
1.9 TDI	1.896	66	4	11.2004-05.2010	BRU, BXF, BXJ		EPBBPT4-V003Z	91742	20	254
1.9 TDI	1.896	74	4	02.2003-05.2004	AVQ		EPBBPT4-V003Z	91742	20	254
1.9 TDI	1.896	77	4	08.2003-05.2010	BKC, BLS, BXE		EPBBPT4-V003Z	91742	20	254
2.0 EcoFuel	1.984	80	4	02.2006-05.2009	BSX		EPBMPT4-V008Z	96201	10	117
2.0 TDI	1.968	100	4	02.2003-05.2010	AZV		EPBBPT4-V002Z	95912	20	300
2.0 TDI	1.968	103	4	12.2005-05.2010	BMM		EPBBPT4-V002Z	95912	20	300
2.0 TDI 16V	1.968	103	4	08.2003-05.2010	BKD		EPBBPT4-V002Z	95912	20	300
2.0 FSI	1.984	110	4	10.2003-01.2007	AXW, BLR, BLX, BLY, BVY, BVZ		EPBMPT4-D005Z	93653	17	117
2.0 TDI	1.968	125	4	12.2005-05.2010	BMN, CFJA		EPBBPT4-V002Z	95912	20	300

TOURAN (1T3)

1.4 TSI	1.390	103	4	05.2010-05.2015	CAVC, CTHC	; Position: Intake Manifold; Position: Throttle Housing	EPBBPT4-V002Z	95912	20	300
1.4 TSI EcoFuel	1.390	110	4	05.2010-05.2015	CDGA	; Position: Intake Manifold; Position: Throttle Housing	EPBBPT4-V002Z	95912	20	300
1.4 TSI	1.390	125	4	05.2010-05.2015	CAVB, CTHB	; Position: Intake Manifold; Position: Throttle Housing	EPBBPT4-V002Z	95912	20	300
1.6 TDI	1.598	66	4	05.2010-05.2015	CAYB		EPBBPT4-V002Z	95912	20	300
1.6 TDI	1.598	77	4	05.2010-05.2015	CAYC		EPBBPT4-V002Z	95912	20	300
2.0 TDI	1.968	81	4	11.2010-05.2015	CFHF, CLCA		EPBBPT4-V002Z	95912	20	300
2.0 TDI	1.968	103	4	05.2010-05.2015	CFHC		EPBBPT4-V002Z	95912	20	300
2.0 TDI	1.968	125	4	05.2010-01.2013	CFJA		EPBBPT4-V002Z	95912	20	300
2.0 TDI	1.968	130	4	01.2013-05.2015	CFJB		EPBBPT4-V002Z	95912	20	300

TOURAN (5T1)

1.2 TSI	1.197	81	4	05.2015-	CYVB		EPBBPT4-V002Z	95912	20	300
1.4 TSI	1.395	110	4	05.2015-	CZDA		EPBBPT4-V002Z	95912	20	300
1.8 TSI	1.798	132	4	11.2015-	CJSA		EPBBPT4-V002Z	95912	20	300

TRANSPORTER IV (70_, 7D, 7D_)

2.5 TDI	2.461	65	5	05.1998-04.2003	AJT	; With Charger Intercooler; Chass. <70-1-200000	EPBMBT4-D001Z	91628	11	254
2.5 TDI	2.461	65	5	05.1998-04.2003	AJT, AYY		EPBBPT4-V003Z	91742	20	254
2.5 TDI	2.461	75	5	09.1995-04.2003	ACV, AUF, AYC		EPBBPT4-V003Z	91742	20	254
2.5 TDI	2.461	75	5	09.1995-04.2003	ACV, AUF, AYC	; With Charger Intercooler; Chass. <70-1-200000	EPBMBT4-D001Z	91628	11	254
2.5 TDI Syncro	2.461	75	5	09.1995-04.2003	ACV, AXL		EPBBPT4-V003Z	91742	20	254
2.5 TDI	2.461	111	5	05.1998-04.2003	AHY, AXG		EPBBPT4-V003Z	91742	20	254



MAP



l kW
C
Y
I



Type-N°

Stock-N°

kPa from
kPa to

VW

TRANSPORTER IV (70_, 7D, 7D_)

2.5 TDI	2.461	111	5	05.1998-04.2003	AHY, AXG	; With Charger Intercooler; Chass. <70-1-200000	EPBMBT4-D001Z	91628	11	254
---------	-------	-----	---	-----------------	----------	---	---------------	-------	----	-----

TRANSPORTER V (7H_, 7E_, 7J_, 7F_)

1.9 TDI	1.896	62	4	01.2006-11.2009	BRR		EPBBPT4-V003Z	91742	20	254
1.9 TDI	1.896	63	4	04.2003-11.2009	AXC		EPBBPT4-V003Z	91742	20	254
1.9 TDI	1.896	77	4	04.2003-11.2009	AXB		EPBBPT4-V003Z	91742	20	254
2.0 TDI	1.968	62	4	09.2009-08.2015	CAAA	; Position: Intake Manifold	EPBMPT4-V008Z	96201	10	117
2.0 TDI	1.968	62	4	09.2009-08.2015	CAAA	; NTC Sensor	EPBBPT4-V002Z	95912	20	300
2.0 TDI	1.968	75	4	09.2009-08.2015	CAAB	; Position: Intake Manifold	EPBMPT4-V008Z	96201	10	117
2.0 TDI	1.968	75	4	09.2009-08.2015	CAAB	; NTC Sensor	EPBBPT4-V002Z	95912	20	300
2.0 TDI	1.968	84	4	05.2011-08.2015	CAAD		EPBMPT4-V008Z	96201	10	117
2.0 TDI	1.968	84	4	05.2011-08.2015	CAAD		EPBBPT4-V002Z	95912	20	300
2.0 TDI	1.968	100	4	05.2010-08.2015	CAAE, CCHB		EPBBPT4-V002Z	95912	20	300
2.0 TDI	1.968	100	4	05.2010-08.2015	CAAE, CCHB	; Position: Intake Manifold	EPBMPT4-V008Z	96201	10	117
2.0 TDI 4motion	1.968	100	4	05.2010-08.2015	CAAE, CCHB		EPBBPT4-V002Z	95912	20	300
2.0 TDI 4motion	1.968	100	4	05.2010-08.2015	CAAE, CCHB	; Position: Intake Manifold	EPBMPT4-V008Z	96201	10	117
2.0 TDI	1.968	103	4	09.2009-08.2015	CAAC	; Position: Intake Manifold	EPBMPT4-V008Z	96201	10	117
2.0 TDI	1.968	103	4	09.2009-08.2015	CAAC, CCHA	; NTC Sensor	EPBBPT4-V002Z	95912	20	300
2.0 TDI 4motion	1.968	103	4	09.2009-08.2015	CAAC, CCHA	; NTC Sensor	EPBBPT4-V002Z	95912	20	300
2.0 TDI 4motion	1.968	103	4	09.2009-08.2015	CAAC, CCHA		EPBMPT4-V008Z	96201	10	117
2.0 BiTDI	1.968	132	4	09.2009-08.2015	CFCA	; Position: Intake Manifold	EPBMPT4-V008Z	96201	10	117
2.0 BiTDI 4motion	1.968	132	4	09.2009-08.2015	CFCA	; Position: Intake Manifold	EPBMPT4-V008Z	96201	10	117
2.5 TDI	2.461	96	5	04.2003-11.2009	AXD, AXE, BNZ		EPBBPT4-V002Z	95912	20	300
2.5 TDI 4motion	2.461	96	5	07.2004-11.2009	AXD, BNZ		EPBBPT4-V002Z	95912	20	300
2.5 TDi	2.461	120	5	11.2003-11.2009	BKD		EPBBPT4-V002Z	95912	20	300
2.5 TDI	2.461	128	5	04.2003-11.2009	AXE, BPC		EPBBPT4-V002Z	95912	20	300
2.5 TDI 4motion	2.461	128	5	07.2004-11.2009	AXE, BPC		EPBBPT4-V002Z	95912	20	300

TRANSPORTER VI (SF_, SJD, SJ, SG_, SH_)

2.0 TDI	1.968	62	4	04.2015-	CAAA, CXGA		EPBBPT4-V002Z	95912	20	300
2.0 TDI	1.968	75	4	04.2015-	CAAB, CXGB		EPBBPT4-V002Z	95912	20	300
2.0 TDI	1.968	103	4	04.2015-	CAAC	; Position: Suction Pipe	EPBMPT4-V008Z	96201	10	117
2.0 TDI	1.968	103	4	04.2015-	CAAC		EPBBPT4-V002Z	95912	20	300
2.0 TDI 4motion	1.968	103	4	06.2015-	CAAC	; Position: Suction Pipe	EPBMPT4-V008Z	96201	10	117
2.0 TDI 4motion	1.968	103	4	06.2015-	CAAC		EPBBPT4-V002Z	95912	20	300

UP! (121, 122, BL1, BL2, BL3, 123)

1.0	999	44	3	08.2011-	CHYA, DAFA		EPBMPT4-V008Z	96201	10	117
1.0 EcoFuel	999	50	3	11.2012-	CPGA		EPBMPT4-V008Z	96201	10	117
1.0	999	55	3	08.2011-	CHYB		EPBMPT4-V008Z	96201	10	117



MAPkW
C
y
I

Type-N°

Stock-N°

kPa from

kPa to

VW**VENTO (1H2) | JETTA III**

1.4	1.390	40	4	11.1991-09.1998	ABD, AEX		EPBMPT4-D025Z	92358	17	115
1.4	1.390	44	4	11.1991-09.1998	ABD, AEX		EPBMPT4-D025Z	92358	17	115

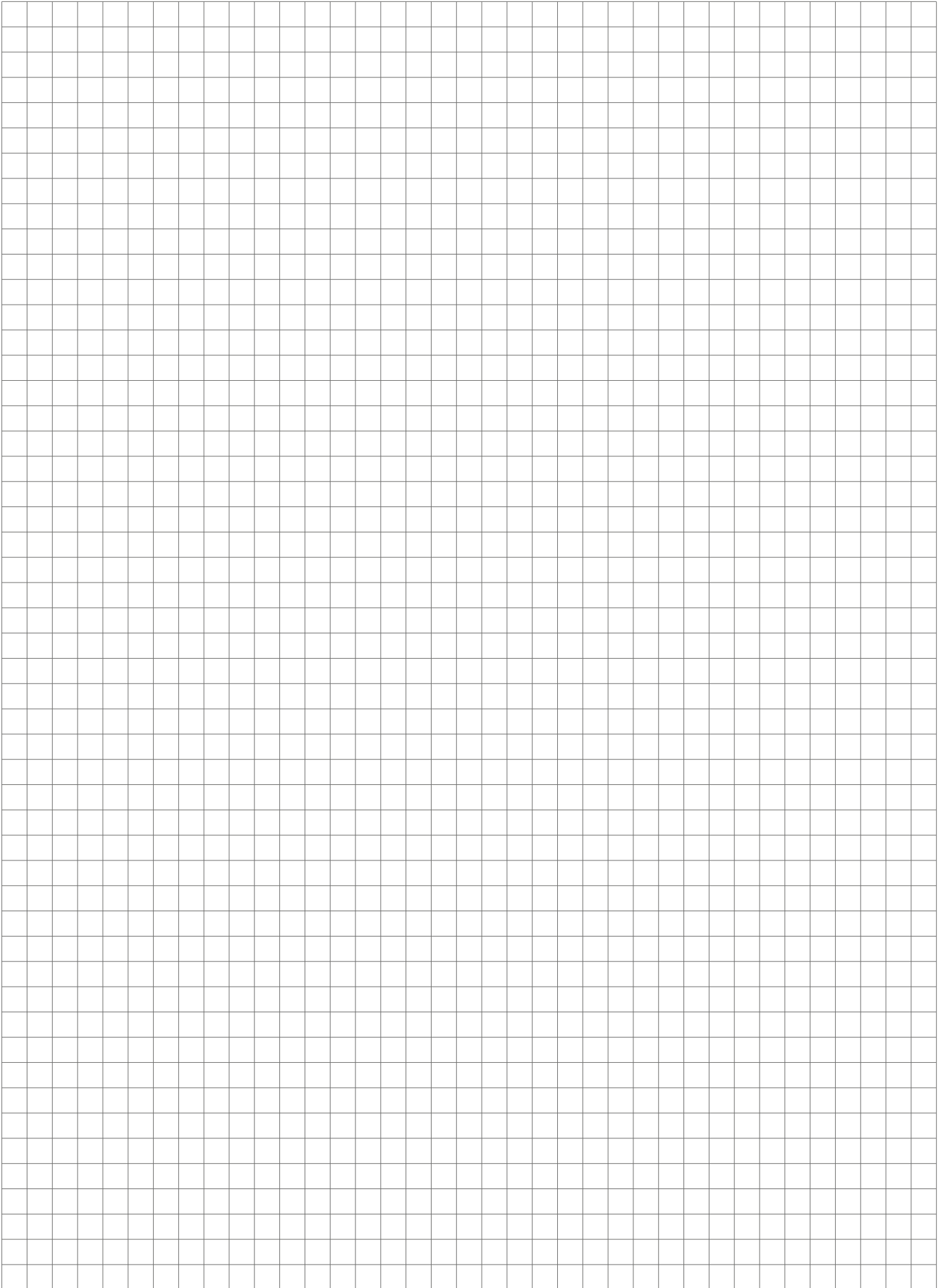

EPBBPN3-A001Z **Stock No. 94263**



Info	kPa from	kPa to
	10	240

EPBBPN3-A005Z **Stock No. 90934**



Info	kPa from	kPa to
	30	240

EPBBPN3-A002Z **Stock No. 94523**



Info	kPa from	kPa to
	15	260

EPBBPN3-A006Z **Stock No. 91736**



Info	kPa from	kPa to
	10	240

EPBBPN3-A003Z **Stock No. 91268**



Info	kPa from	kPa to
	10	250

EPBBPN3-A009Z **Stock No. 96930**



Info	kPa from	kPa to
	50	250

EPBBPN3-A004Z **Stock No. 97711**



Info	kPa from	kPa to
	50	300

EPBBPN3-A011Z **Stock No. 91149**



Info	kPa from	kPa to
	50	310

EPBBPN3-A012Z **Stock No. 91308**



Info	kPa from	kPa to
	25	290

EPBBPN3-A018Z **Stock No. 95753**



Info	kPa from	kPa to
	35	320

EPBBPN3-A013Z **Stock No. 95023**



Info	kPa from	kPa to
	30	245

EPBBPN3-A020Z **Stock No. 91829**



Info	kPa from	kPa to
	40	415

EPBBPN3-A015Z **Stock No. 96911**



Info	kPa from	kPa to
	20	250

EPBBPN3-A022Z **Stock No. 92949**



Info	kPa from	kPa to
	20	250

EPBBPN3-A017Z **Stock No. 95311**



Info	kPa from	kPa to
	35	320

EPBBPN3-A024Z **Stock No. 91449**



Info	kPa from	kPa to
	50	350

EPBBPN3-A025Z **Stock No. 97101**



Info	kPa from	kPa to
	20	250

EPBBPN3-A031Z **Stock No. 95922**



Info	kPa from	kPa to
	40	250

EPBBPN3-A026Z **Stock No. 96088**



Info	kPa from	kPa to
	40	250

EPBBPN3-A032Z **Stock No. 96503**



Info	kPa from	kPa to
	50	250

EPBBPN3-A027Z **Stock No. 92471**



Info	kPa from	kPa to
	10	200

EPBBPN3-A033Z **Stock No. 96394**



Info	kPa from	kPa to
	20	200

EPBBPN3-A028Z **Stock No. 93277**



Info	kPa from	kPa to
	20	200

EPBBPN3-V007Z **Stock No. 97073**



Info	kPa from	kPa to
	20	300

EPBBPN3-V008Z **Stock No. 90842**



Info	kPa from	kPa to
	20	250

EPBBPN3-V019Z **Stock No. 95201**



Info	kPa from	kPa to
	20	250

EPBBPN3-V010Z **Stock No. 95936**



Info	kPa from	kPa to
	20	250

EPBBPN3-V021Z **Stock No. 95679**



Info	kPa from	kPa to
	20	300

EPBBPN3-V014Z **Stock No. 96895**



Info	kPa from	kPa to
	20	250

EPBBPN3-V023Z **Stock No. 90603**



Info	kPa from	kPa to
	20	250

EPBBPN3-V016Z **Stock No. 92713**



Info	kPa from	kPa to
	50	350

EPBBPN3-V029Z **Stock No. 92983**



Info	kPa from	kPa to
	20	270

EPBBPN3-V030Z **Stock No. 94092**



Info	kPa from	kPa to
	50	465

EPBBPN4-V014Z **Stock No. 93428**



Info	kPa from	kPa to
	20	250

EPBBPN3-V034Z **Stock No. 96381**



Info	kPa from	kPa to
	20	250

EPBBPT4-A011Z **Stock No. 94601**



Info	kPa from	kPa to
	20	300

EPBBPN4-A020Z **Stock No. 92413**



Info	kPa from	kPa to
	50	350

EPBBPT4-A016Z **Stock No. 95268**



Info	kPa from	kPa to
	15	260

EPBBPN4-V004Z **Stock No. 93057**



Info	kPa from	kPa to
	50	350

EPBBPT4-A017Z **Stock No. 92559**





Info	kPa from	kPa to
	50	300

EPBBPT4-V001Z **Stock No. 92565**



Info	kPa from	kPa to
	11	307

EPBBPT4-V006Z **Stock No. 96941**

Info	kPa from	kPa to
	15	250

EPBBPT4-V002Z **Stock No. 95912**



Info	kPa from	kPa to
	20	300

EPBBPT4-V007Z **Stock No. 94941**



Info	kPa from	kPa to
	20	250

EPBBPT4-V003Z **Stock No. 91742**



Info	kPa from	kPa to
	20	254

EPBBPT4-V008Z **Stock No. 92801**



Info	kPa from	kPa to
	15	245

EPBBPT4-V005Z **Stock No. 93700**



Info	kPa from	kPa to
	20	250

EPBBPT4-V009Z **Stock No. 95675**



Info	kPa from	kPa to
	20	300

EPBBPT4-V010Z **Stock No. 91257**



Info	kPa from	kPa to
	20	250

EPBBPT4-V018Z **Stock No. 91887**



Info	kPa from	kPa to
	50	600

EPBBPT4-V012Z **Stock No. 96542**

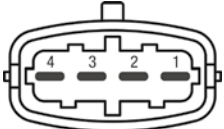
Info	kPa from	kPa to
	20	250

EPBBPT4-V019Z **Stock No. 95582**



Info	kPa from	kPa to
	20	250

EPBBPT4-V013Z **Stock No. 91803**



Info	kPa from	kPa to
	20	250

EPBBPT4-V021Z **Stock No. 97219**



Info	kPa from	kPa to
	10	250

EPBBPT4-V015Z **Stock No. 94877**



Info	kPa from	kPa to
	20	300

EPBBPT4-V023Z **Stock No. 94656**



Info	kPa from	kPa to
	50	400

EPBBPT4-V024Z **Stock No. 92064**



Info	kPa from	kPa to
	40	360

EPBMBN3-V004Z **Stock No. 90962**



Info	kPa from	kPa to
	10	270,3

EPBMBN3-A003Z **Stock No. 90717**



Info	kPa from	kPa to
	28,9	400

EPBMBN3-V005Z **Stock No. 90946**



Info	kPa from	kPa to
	27,8	400

EPBMBN3-V001Z **Stock No. 92099**



Info	kPa from	kPa to
	20	256

EPBMBN3-V006Z **Stock No. 94835**



Info	kPa from	kPa to
	18,2	300,2

EPBMBN3-V002Z **Stock No. 94886**



Info	kPa from	kPa to
	27,2	400

EPBMBN3-V007Z **Stock No. 96602**



Info	kPa from	kPa to
	-	-

EPBMBT4-A002Z **Stock No. 92144**



Info	kPa from	kPa to
	30,8	369,2

EPBMPN3-A002Z **Stock No. 96249**



Info	kPa from	kPa to
	15	100

EPBMBT4-A003Z **Stock No. 93024**



Info	kPa from	kPa to
	12,9	316,5

EPBMPN3-A003Z **Stock No. 92477**



Info	kPa from	kPa to
	15	102

EPBMBT4-D001Z **Stock No. 91628**



Info	kPa from	kPa to
	11	254

EPBMPN3-A004Z **Stock No. 90833**



Info	kPa from	kPa to
	10	120

EPBMBT4-V004Z **Stock No. 96629**



Info	kPa from	kPa to
	11,9	261,9

EPBMPN3-A007Z **Stock No. 96754**



Info	kPa from	kPa to
	20	105

EPBMPN3-A009Z **Stock No. 92952**



Info	kPa from	kPa to
	20	100

EPBMPN3-A020Z **Stock No. 96725**



Info	kPa from	kPa to
	20	117

EPBMPN3-A014Z **Stock No. 90281**



Info	kPa from	kPa to
	10	130

EPBMPN3-A023Z **Stock No. 96241**



Info	kPa from	kPa to
	10	130

EPBMPN3-A015Z **Stock No. 94611**



Info	kPa from	kPa to
	10	165

EPBMPN3-A027Z **Stock No. 90915**



Info	kPa from	kPa to
	20	105

EPBMPN3-A016Z **Stock No. 96896**

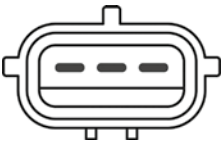
Info	kPa from	kPa to
	10	115

EPBMPN3-A028Z **Stock No. 93480**



Info	kPa from	kPa to
	10	115

EPBMPN3-A033Z **Stock No. 96422**



Info	kPa from	kPa to
	20	200

EPBMPN3-A037Z **Stock No. 94170**



Info	kPa from	kPa to
	10	130

EPBMPN3-A034Z **Stock No. 92094**



Info	kPa from	kPa to
	20	115

EPBMPN3-A038Z **Stock No. 94914**

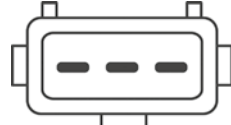
Info	kPa from	kPa to
	50	450

EPBMPN3-A035Z **Stock No. 92810**



Info	kPa from	kPa to
	20	100

EPBMPN3-A039Z **Stock No. 97513**



Info	kPa from	kPa to
	15	135

EPBMPN3-A036Z **Stock No. 95612**



Info	kPa from	kPa to
	20	105

EPBMPN3-A040Z **Stock No. 94558**



Info	kPa from	kPa to
	20	100

EPBMPN3-A043Z **Stock No. 92940**



Info	kPa from	kPa to
	20	250

EPBMPN3-A048Z **Stock No. 94778**



Info	kPa from	kPa to
	-	-

EPBMPN3-A044Z **Stock No. 93056**



Info	kPa from	kPa to
	-	-

EPBMPN3-A049Z **Stock No. 93927**



Info	kPa from	kPa to
	-	-

EPBMPN3-A045Z **Stock No. 93151**



Info	kPa from	kPa to
	10	130

EPBMPN3-A050Z **Stock No. 96018**



Info	kPa from	kPa to
	-	-

EPBMPN3-A047Z **Stock No. 90252**



Info	kPa from	kPa to
	-	-

EPBMPN3-A051Z **Stock No. 92149**



Info	kPa from	kPa to
	-	-

EPBMPN3-A052Z **Stock No. 93614**



Info	kPa from	kPa to
	-	-

EPBMPN3-V001Z **Stock No. 90037**



Info	kPa from	kPa to
	20	100

EPBMPN3-D029Z **Stock No. 95772**



Info	kPa from	kPa to
	15	115

EPBMPN3-V005Z **Stock No. 93871**



Info	kPa from	kPa to
	20	100

EPBMPN3-R012Z **Stock No. 96590**



Info	kPa from	kPa to
	10	170

EPBMPN3-V006Z **Stock No. 97501**



Info	kPa from	kPa to
	30	190

EPBMPN3-R046Z **Stock No. 95625**



Info	kPa from	kPa to
	10	160

EPBMPN3-V008Z **Stock No. 90549**



Info	kPa from	kPa to
	40	250

EPBMPN3-V010Z **Stock No. 93991**



Info	kPa from	kPa to
	10	117,5

EPBMPN3-V018Z **Stock No. 97066**



Info	kPa from	kPa to
	20	950

EPBMPN3-V011Z **Stock No. 94242**



Info	kPa from	kPa to
	20	115

EPBMPN3-V019Z **Stock No. 93061**



Info	kPa from	kPa to
	10	307,5

EPBMPN3-V013Z **Stock No. 94788**



Info	kPa from	kPa to
	15	255

EPBMPN3-V021Z **Stock No. 92226**



Info	kPa from	kPa to
	-	-

EPBMPN3-V017Z **Stock No. 91253**



Info	kPa from	kPa to
	10	120

EPBMPN3-V022Z **Stock No. 91412**



Info	kPa from	kPa to
	10	117

EPBMPN3-V024Z **Stock No. 93159**



Info	kPa from	kPa to
	26,9	400

EPBMPN3-V031Z **Stock No. 92481**



Info	kPa from	kPa to
	10	120

EPBMPN3-V025Z **Stock No. 94855**



Info	kPa from	kPa to
	10	138,7

EPBMPN3-V032Z **Stock No. 94413**



Info	kPa from	kPa to
	10	213,5

EPBMPN3-V026Z **Stock No. 94423**



Info	kPa from	kPa to
	10	117,9

EPBMPN3-V041Z **Stock No. 92257**



Info	kPa from	kPa to
	10	121,7

EPBMPN3-V030Z **Stock No. 92953**



Info	kPa from	kPa to
	10	115

EPBMPN3-V042Z **Stock No. 92659**



Info	kPa from	kPa to
	15	102

EPBMPN4-A023Z **Stock No. 91984**



Info	kPa from	kPa to
	11,2	307,2

EPBMPN4-V013Z **Stock No. 93089**



Info	kPa from	kPa to
	10	117

EPBMPN4-A034Z **Stock No. 95507**



Info	kPa from	kPa to
	10	115

EPBMPN4-V040Z **Stock No. 95972**



Info	kPa from	kPa to
	20	115

EPBMPN4-A035Z **Stock No. 96317**



Info	kPa from	kPa to
	10	115

EPBMPN4-V041Z **Stock No. 94063**



Info	kPa from	kPa to
	10	115

EPBMPN4-D019Z **Stock No. 91102**



Info	kPa from	kPa to
	16,9	116,9

EPBMPT4-A001Z **Stock No. 93136**



Info	kPa from	kPa to
	10	117

EPBMPT4-A006Z **Stock No. 96115**



Info	kPa from	kPa to
	-	-

EPBMPT4-A024Z **Stock No. 91744**



Info	kPa from	kPa to
	50	349,8

EPBMPT4-A007Z **Stock No. 96755**



Info	kPa from	kPa to
	10	120

EPBMPT4-A030Z **Stock No. 96501**



Info	kPa from	kPa to
	10	130

EPBMPT4-A017Z **Stock No. 96798**



Info	kPa from	kPa to
	10	115

EPBMPT4-A036Z **Stock No. 97175**



Info	kPa from	kPa to
	10	115

EPBMPT4-A020Z **Stock No. 97897**



Info	kPa from	kPa to
	10	115

EPBMPT4-A046Z **Stock No. 92256**



Info	kPa from	kPa to
	-	-

EPBMPT4-D005Z **Stock No. 93653**



Info	kPa from	kPa to
	17	117

EPBMPT4-V003Z **Stock No. 93266**



Info	kPa from	kPa to
	10	118

EPBMPT4-D025Z **Stock No. 92358**



Info	kPa from	kPa to
	17	115

EPBMPT4-V004Z **Stock No. 92899**



Info	kPa from	kPa to
	20	115

EPBMPT4-D042Z **Stock No. 91710**



Info	kPa from	kPa to
	-	-

EPBMPT4-V008Z **Stock No. 96201**



Info	kPa from	kPa to
	10	117

EPBMPT4-V002Z **Stock No. 94153**



Info	kPa from	kPa to
	40	261

EPBMPT4-V009Z **Stock No. 96309**



Info	kPa from	kPa to
	10	117

EPBMPT4-V010Z **Stock No. 96347**



Info	kPa from	kPa to
	10	115

EPBMPT4-V015Z **Stock No. 95488**



Info	kPa from	kPa to
	10	117

EPBMPT4-V011Z **Stock No. 91119**



Info	kPa from	kPa to
	20	115

EPBMPT4-V016Z **Stock No. 92071**



Info	kPa from	kPa to
	10	110

EPBMPT4-V012Z **Stock No. 91940**



Info	kPa from	kPa to
	20	100

EPBMPT4-V018Z **Stock No. 95148**



Info	kPa from	kPa to
	10	120

EPBMPT4-V014Z **Stock No. 97115**



Info	kPa from	kPa to
	25	950

EPBMPT4-V021Z **Stock No. 97498**



Info	kPa from	kPa to
	15	120

EPBMPT4-V022Z **Stock No. 90125**



Info	kPa from	kPa to
	15	102

EPBMPT4-V029Z **Stock No. 90509**



Info	kPa from	kPa to
	12,7	255,3

EPBMPT4-V026Z **Stock No. 91770**



Info	kPa from	kPa to
	12	236

EPBMPT4-V031Z **Stock No. 94763**



Info	kPa from	kPa to
	18,2	300,2

EPBMPT4-V027Z **Stock No. 93059**



Info	kPa from	kPa to
	10	211,5

EPBMPT4-V032Z **Stock No. 96108**



Info	kPa from	kPa to
	-	-

EPBMPT4-V028Z **Stock No. 93902**



Info	kPa from	kPa to
	11,2	250

EPBMPT4-V033Z **Stock No. 90173**



Info	kPa from	kPa to
	-	-

EPBMPT4-V037Z **Stock No. 92354**



Info	kPa from	kPa to
	15	117

EPBMPT4-V044Z **Stock No. 96079**



Info	kPa from	kPa to
	15	102

EPBMPT4-V038Z **Stock No. 94727**



Info	kPa from	kPa to
	-	-

EPBMPT4-V045Z **Stock No. 91802**



Info	kPa from	kPa to
	-	-

EPBMPT4-V039Z **Stock No. 96769**



Info	kPa from	kPa to
	10	115

EPBMPT4-V043Z **Stock No. 97765**



Info	kPa from	kPa to
	20	115



CROSS REFERENCE GUIDE

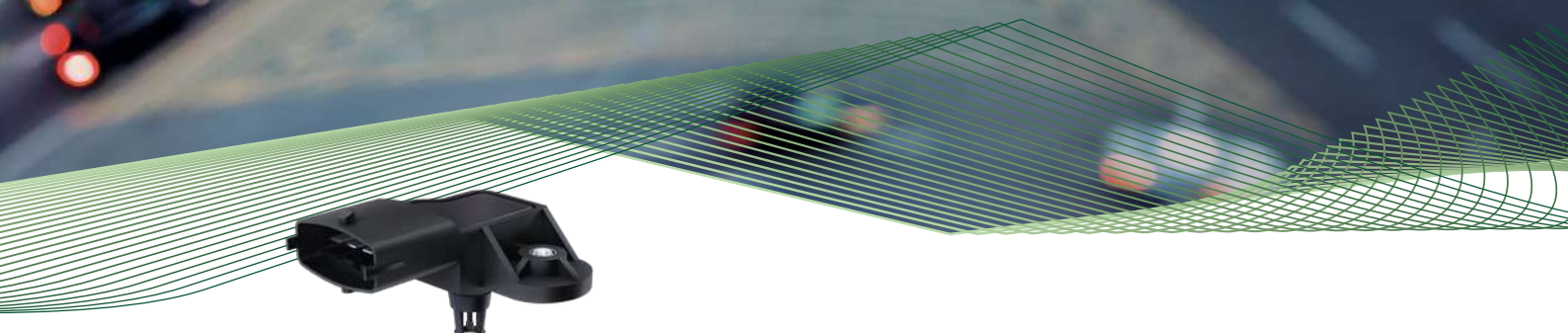

VEHICLE
ELECTRONICS

ABARTH	→ NTK	Stock
272880	EPBBPT4-V001Z	92565
7084986	EPBMPT4-V003Z	93266
7696064	EPBMPN3-A003Z	92477
7714662	EPBMPN3-A002Z	96249
7750716	EPBMPN3-A043Z	92940
46451792	EPBMPT4-V012Z	91940
46468682	EPBBPN3-V034Z	96381
46474585	EPBMPT4-V032Z	96108
46531222	EPBMPN3-A002Z	96249
46533518	EPBMPT4-V003Z	93266
46553045	EPBMPT4-V003Z	93266
46769978	EPBBPT4-V010Z	91257
46769979	EPBMPN3-V022Z	91412
46811235	EPBMBN3-V001Z	92099
55206796	EPBMBN3-V001Z	92099
55206797	EPBBPT4-V001Z	92565
55209037	EPBMPT4-V003Z	93266
55209194	EPBBPN3-V007Z	97073
55219294	EPBMBN3-V001Z	92099
55219295	EPBBPN3-V007Z	97073
55219298	EPBBPT4-V001Z	92565
55238125	EPBBPT4-V010Z	91257
60809804	EPBMPN3-A043Z	92940
60811067	EPBMPN3-A002Z	96249
60811534	EPBMPN3-A003Z	92477
60814507	EPBMPN3-A002Z	96249
71714218	EPBMPT4-V012Z	91940
71718233	EPBMPT4-V012Z	91940
71718678	EPBMPT4-V012Z	91940
71728656	EPBMPT4-V012Z	91940
71732447	EPBMPT4-V003Z	93266
71739292	EPBMPN3-V005Z	93871
71741115	EPBMPN3-V010Z	93991
71742176	EPBMPN3-V031Z	92481
73503657	EPBBPT4-V001Z	92565
77363792	EPBMPN3-V022Z	91412
77364145	EPBMPT4-V003Z	93266
77364543	EPBBPT4-V010Z	91257
77364869	EPBMPT4-V003Z	93266
77365393	EPBBPT4-V001Z	92565
77366837	EPBMPT4-V028Z	93902
500309838	EPBMPN3-A002Z	96249
500351377	EPBBPT4-V005Z	93700
504064370	EPBBPT4-V010Z	91257
504088431	EPBBPT4-V001Z	92565
504245257	EPBBPT4-V001Z	92565
552182980	EPBBPT4-V001Z	92565
9609992380	EPBMPN3-A002Z	96249
9618261580	EPBMPN3-A009Z	92952
9619114980	EPBBPN3-A027Z	92471
9631716680	EPBBPN3-A003Z	91268
9631813680	EPBMPN3-A007Z	96754

ABARTH	→ NTK	Stock
9639381480	EPBMPT4-A001Z	93136
9639418880	EPBMPN3-A007Z	96754
9639418980	EPBMPN3-A020Z	96725
9639469280	EPBBPN3-A001Z	94263
9642789980	EPBBPN3-A006Z	91736
9649396580	EPBBPN3-A018Z	95753
9651931280	EPBBPN3-A017Z	95311
9660603480	EPBBPT4-A011Z	94601
9663480880	EPBMBT4-A003Z	93024
ACURA	→ NTK	Stock
37830P13003	EPBMPN3-R046Z	95625
AGRALE	→ NTK	Stock
6013001034005	EPBBPT4-V005Z	93700
6013101125001	EPBBPT4-V001Z	92565
ALFA ROMEO	→ NTK	Stock
272880	EPBBPT4-V001Z	92565
7084986	EPBMPT4-V003Z	93266
7696064	EPBMPN3-A003Z	92477
7714662	EPBMPN3-A002Z	96249
7750716	EPBMPN3-A043Z	92940
46451792	EPBMPT4-V012Z	91940
46468682	EPBBPN3-V034Z	96381
46474585	EPBMPT4-V032Z	96108
46531222	EPBMPN3-A002Z	96249
46533518	EPBMPT4-V003Z	93266
46553045	EPBMPT4-V003Z	93266
46769978	EPBBPT4-V010Z	91257
46769979	EPBMPN3-V022Z	91412
46811235	EPBMBN3-V001Z	92099
55206796	EPBMBN3-V001Z	92099
55206797	EPBBPT4-V001Z	92565
55209037	EPBMPT4-V003Z	93266
55209194	EPBBPN3-V007Z	97073
55219294	EPBMBN3-V001Z	92099
55219295	EPBBPN3-V007Z	97073
55219298	EPBBPT4-V001Z	92565
55238125	EPBBPT4-V010Z	91257
60809804	EPBMPN3-A043Z	92940
60811067	EPBMPN3-A002Z	96249
60811534	EPBMPN3-A003Z	92477
60814507	EPBMPN3-A002Z	96249
71714218	EPBMPT4-V012Z	91940
71718233	EPBMPT4-V012Z	91940
71718678	EPBMPT4-V012Z	91940
71728656	EPBMPT4-V012Z	91940
71732447	EPBMPT4-V003Z	93266
71739292	EPBMPN3-V005Z	93871
71741115	EPBMPN3-V010Z	93991
71742176	EPBMPN3-V031Z	92481
73503657	EPBBPT4-V001Z	92565
77363792	EPBMPN3-V022Z	91412
77364145	EPBMPT4-V003Z	93266

ALFA ROMEO	→ NTK	Stock
77364543	EPBBPT4-V010Z	91257
77364869	EPBMPT4-V003Z	93266
77365393	EPBBPT4-V001Z	92565
77366191	EPBBPT4-V010Z	91257
77366837	EPBMPT4-V028Z	93902
500309838	EPBMPN3-A002Z	96249
500351377	EPBBPT4-V005Z	93700
504064370	EPBBPT4-V010Z	91257
504088431	EPBBPT4-V001Z	92565
504245257	EPBBPT4-V001Z	92565
552182980	EPBBPT4-V001Z	92565
9609992380	EPBMPN3-A002Z	96249
9618261580	EPBMPN3-A009Z	92952
9619114980	EPBBPN3-A027Z	92471
9631716680	EPBBPN3-A003Z	91268
9631813680	EPBMPN3-A007Z	96754
9639381480	EPBMPT4-A001Z	93136
9639418880	EPBMPN3-A007Z	96754
9639418980	EPBMPN3-A020Z	96725
9639469280	EPBBPN3-A001Z	94263
9642789980	EPBBPN3-A006Z	91736
9649396580	EPBBPN3-A018Z	95753
9651931280	EPBBPN3-A017Z	95311
9660603480	EPBBPT4-A011Z	94601
9663480880	EPBMBT4-A003Z	93024
ASIA MOTORS	→ NTK	Stock
GW10018211	EPBMPT4-V043Z	97765
ASTON MARTIN	→ NTK	Stock
8942152010	EPBMPT4-A030Z	96501
HY5312B676AA	EPBBPT4-V001Z	92565
AUDI	→ NTK	Stock
36906051	EPBMPT4-V004Z	92899
38906051	EPBMBT4-D001Z	91628
47906051	EPBMPT4-V022Z	90125
47906051	EPBMPT4-V022Z	90125
59906051	EPBBPT4-V019Z	95582
62906051	EPBMBT4-D001Z	91628
279980411	EPBMPT4-V008Z	96201
369980411	EPBMPT4-V004Z	92899
030906051A	EPBMPT4-D025Z	92358
036906051C	EPBMPN4-D019Z	91102
036906051D	EPBMPT4-V004Z	92899
036906051E	EPBMPN4-V040Z	95972
036906051F	EPBMPN4-V041Z	94063
036906051G	EPBMPN4-V013Z	93089
038906051A	EPBBPT4-V015Z	94877
038906051B	EPBBPT4-V003Z	91742
038906051C	EPBBPT4-V002Z	95912
038906051D	EPBBPN4-V014Z	93428
03C906051	EPBMPT4-V008Z	96201
03C906051F	EPBMPT4-V008Z	96201
03D906051	EPBMPT4-V011Z	91119

AUDI	→ NTK	Stock
03D906051A	EPBMPT4-V011Z	91119
03G906051D	EPBBPT4-V003Z	91742
03G906051E	EPBBPT4-V002Z	95912
03G906051F	EPBBPT4-V002Z	95912
046130385A	EPBBPN3-A013Z	95023
04E906051	EPBBPT4-V002Z	95912
06B906051	EPBMPT4-D005Z	93653
07C906051	EPBMPT4-D042Z	91710
1K0612041BT	EPBMPN4-V013Z	93089
1K0612041DH	EPBMPN4-V013Z	93089
1K0612041FE	EPBMPN4-V013Z	93089
1K0612041FR	EPBMPN4-V013Z	93089
1K0612041GH	EPBMPN4-V013Z	93089
2E0906051A	EPBMPN3-A004Z	90833
2P0906051	EPBBPT4-V005Z	93700
377906309C	EPBMPN3-A002Z	96249
3A0906051	EPBMPN3-A027Z	90915
5N0612041AH	EPBMPN4-V013Z	93089
6R1612041H	EPBMPN4-V013Z	93089
6R1612041P	EPBMPN4-V013Z	93089
6R2612041AE	EPBMPN4-V013Z	93089
6R2612041J	EPBMPN4-V013Z	93089
6R2612051AE	EPBMPN4-V013Z	93089
7N0612041C	EPBMPN4-V013Z	93089
BAW	→ NTK	Stock
G4AA3808030	EPBBPT4-V001Z	92565
BENTLEY	→ NTK	Stock
36906051	EPBMPT4-V004Z	92899
36906051	EPBMPT4-V004Z	92899
38906051	EPBMBT4-D001Z	91628
38906051	EPBMBT4-D001Z	91628
47906051	EPBMPT4-V022Z	90125
47906051	EPBMPT4-V022Z	90125
59906051	EPBBPT4-V019Z	95582
59906051	EPBBPT4-V019Z	95582
62906051	EPBMBT4-D001Z	91628
279980411	EPBMPT4-V008Z	96201
369980411	EPBMPT4-V004Z	92899
030906051A	EPBMPT4-D025Z	92358
036906051C	EPBMPN4-D019Z	91102
036906051D	EPBMPT4-V004Z	92899
036906051E	EPBMPN4-V040Z	95972
036906051F	EPBMPN4-V041Z	94063
036906051G	EPBMPN4-V013Z	93089
038906051A	EPBBPT4-V015Z	94877
038906051B	EPBBPT4-V003Z	91742
038906051C	EPBBPT4-V002Z	95912
038906051D	EPBBPN4-V014Z	93428
03C906051	EPBMPT4-V008Z	96201
03C906051F	EPBMPT4-V008Z	96201
03D906051	EPBMPT4-V011Z	91119
03D906051A	EPBMPT4-V011Z	91119



BENTLEY	→ NTK	Stock
03G906051D	EPBBPT4-V003Z	91742
03G906051E	EPBBPT4-V002Z	95912
03G906051F	EPBBPT4-V002Z	95912
046130385A	EPBBPN3-A013Z	95023
06B906051	EPBMPT4-D005Z	93653
07C906051	EPBMPT4-D042Z	91710
1K0612041BT	EPBMPN4-V013Z	93089
1K0612041DH	EPBMPN4-V013Z	93089
1K0612041FE	EPBMPN4-V013Z	93089
1K0612041FR	EPBMPN4-V013Z	93089
1K0612041GH	EPBMPN4-V013Z	93089
2E0906051A	EPBMPN3-A004Z	90833
2P0906051	EPBBPT4-V005Z	93700
377906309C	EPBMPN3-A002Z	96249
3A0906051	EPBMPN3-A027Z	90915
5N0612041AH	EPBMPN4-V013Z	93089
6R1612041H	EPBMPN4-V013Z	93089
6R1612041P	EPBMPN4-V013Z	93089
6R2612041AE	EPBMPN4-V013Z	93089
6R2612041J	EPBMPN4-V013Z	93089
6R2612051AE	EPBMPN4-V013Z	93089
7N0612041C	EPBMPN4-V013Z	93089
BMW	→ NTK	Stock
872648	EPBMPT4-V009Z	96309
872679	EPBBPT4-V008Z	92801
2244674	EPBBPN3-A013Z	95023
2246977	EPBBPN3-A005Z	90934
7540508	EPBBPN3-A024Z	91449
7551429	EPBBPT4-V006Z	96941
7585493	EPBBPT4-V006Z	96941
7787142	EPBBPN3-A004Z	97711
7804742	EPBMBN3-V002Z	94886
8637896	EPBMBN3-V002Z	94886
12140872648	EPBMPT4-V009Z	96309
12140872679	EPBBPT4-V008Z	92801
13327785354	EPBBPN3-A020Z	91829
13617787142	EPBBPN3-A004Z	97711
13622244674	EPBBPN3-A013Z	95023
13622246977	EPBBPN3-A005Z	90934
13627535069	EPBBPT4-A016Z	95268
13627539811	EPBMPT4-A006Z	96115
13627540508	EPBBPN3-A024Z	91449
13627551429	EPBBPT4-V006Z	96941
13627582552	EPBMPN3-A044Z	93056
13627585493	EPBBPT4-V006Z	96941
13627599907	EPBBPN3-V030Z	94092
13627794981	EPBBPN3-A001Z	94263
13627801387	EPBMBN3-V004Z	90962
13627804742	EPBMBN3-V002Z	94886
13627966237	EPBBPT4-V010Z	91257
13628570118	EPBMBN3-V002Z	94886
13628637896	EPBMBN3-V002Z	94886

BUICK	→ NTK	Stock
1235046	EPBMPN3-V005Z	93871
9109593	EPBMBN3-V001Z	92099
9109787	EPBMPT4-V029Z	90509
9117763	EPBMPN3-A028Z	93480
9160331	EPBMPN3-A033Z	96422
9197948	EPBBPT4-V021Z	97219
9389131	EPBMPN3-A003Z	92477
12568929	EPBMPT4-V003Z	93266
12569240	EPBMPN3-A003Z	92477
12569241	EPBMPN3-A033Z	96422
12575467	EPBMPN3-V010Z	93991
12591290	EPBMPN3-V017Z	91253
12592017	EPBMBT4-V004Z	96629
12614970	EPBMPN3-V005Z	93871
12644228	EPBMPN3-V017Z	91253
12788793	EPBMPT4-V026Z	91770
16040609	EPBMPN3-A033Z	96422
16137039	EPBMPN3-A003Z	92477
16153989	EPBBPN3-A026Z	96088
16172899	EPBBPN3-A025Z	97101
16212460	EPBMPN3-V005Z	93871
16235939	EPBMPN3-V006Z	97501
16255839	EPBMPN3-V013Z	94788
16258659	EPBMPN3-V005Z	93871
24420587	EPBMPN3-V010Z	93991
24420761	EPBBPN3-A012Z	91308
25184080	EPBMPN3-V011Z	94242
25184087	EPBMPN3-V042Z	92659
28074365	EPBMPN3-V005Z	93871
55206797	EPBBPT4-V001Z	92565
55219294	EPBMBN3-V001Z	92099
55219298	EPBBPT4-V001Z	92565
55563262	EPBBPT4-V021Z	97219
55563267	EPBMPT4-V026Z	91770
55563375	EPBMPN3-V041Z	92257
55567257	EPBBPN3-V029Z	92983
55568175	EPBBPT4-V001Z	92565
55573248	EPBMPN3-V017Z	91253
55576223	EPBBPT4-V010Z	91257
90063543	EPBMPN3-V005Z	93871
90467558	EPBBPN3-A013Z	95023
90541409	EPBBPN3-A015Z	96911
91167213	EPBBPN3-V008Z	90842
93168455	EPBBPN3-V016Z	92713
93170309	EPBBPT4-V010Z	91257
93171176	EPBBPT4-V001Z	92565
93171579	EPBBPN3-A005Z	90934
93171659	EPBBPN3-A020Z	91829
93177414	EPBMBN3-V001Z	92099
93190052	EPBMBN3-V001Z	92099
93192107	EPBMPN3-V017Z	91253
93194115	EPBMBN3-V001Z	92099

BUICK	→ NTK	Stock
93194419	EPBMPN3-V026Z	94423
93198487	EPBMPN3-V001Z	90037
93198753	EPBBPN3-V007Z	97073
93232415	EPBMPT4-V043Z	97765
93342430	EPBBPT4-V005Z	93700
93399801	EPBMPT4-V038Z	94727
93857938	EPBBPN3-V007Z	97073
95512846	EPBMPT4-V003Z	93266
96276354	EPBMPN3-V011Z	94242
96325870	EPBMPN3-V021Z	92226
96330547	EPBMPN3-V011Z	94242
96333468	EPBMPN3-V042Z	92659
96482570	EPBMPN3-V018Z	97066
97180655	EPBMPN3-V006Z	97501
97287868	EPBBPN3-V010Z	95936
97381191	EPBMBT4-A002Z	92144
BYD	→ NTK	Stock
3600040E	EPBMPT4-D025Z	92358
CADILLAC	→ NTK	Stock
1235046	EPBMPN3-V005Z	93871
9109593	EPBMBN3-V001Z	92099
9109787	EPBMPT4-V029Z	90509
9117763	EPBMPN3-A028Z	93480
9160331	EPBMPN3-A033Z	96422
9197948	EPBBPT4-V021Z	97219
9389131	EPBMPN3-A003Z	92477
12568929	EPBMPT4-V003Z	93266
12569240	EPBMPN3-A003Z	92477
12569241	EPBMPN3-A033Z	96422
12575467	EPBMPN3-V010Z	93991
12591290	EPBMPN3-V017Z	91253
12592017	EPBMBT4-V004Z	96629
12614970	EPBMPN3-V005Z	93871
12644228	EPBMPN3-V017Z	91253
12788793	EPBMPT4-V026Z	91770
16040609	EPBMPN3-A033Z	96422
16137039	EPBMPN3-A003Z	92477
16153989	EPBBPN3-A026Z	96088
16172899	EPBBPN3-A025Z	97101
16212460	EPBMPN3-V005Z	93871
16235939	EPBMPN3-V006Z	97501
16255839	EPBMPN3-V013Z	94788
16258659	EPBMPN3-V005Z	93871
24420587	EPBMPN3-V010Z	93991
24420761	EPBBPN3-A012Z	91308
25184080	EPBMPN3-V011Z	94242
25184087	EPBMPN3-V042Z	92659
28074365	EPBMPN3-V005Z	93871
55206797	EPBBPT4-V001Z	92565
55219294	EPBMBN3-V001Z	92099
55219298	EPBBPT4-V001Z	92565
55563262	EPBBPT4-V021Z	97219

CADILLAC	→ NTK	Stock
55563267	EPBMPT4-V026Z	91770
55563375	EPBMPN3-V041Z	92257
55567257	EPBBPN3-V029Z	92983
55568175	EPBBPT4-V001Z	92565
55573248	EPBMPN3-V017Z	91253
55576223	EPBBPT4-V010Z	91257
90063543	EPBMPN3-V005Z	93871
90467558	EPBBPN3-A013Z	95023
90541409	EPBBPN3-A015Z	96911
91167213	EPBBPN3-V008Z	90842
93168455	EPBBPN3-V016Z	92713
93170309	EPBBPT4-V010Z	91257
93171176	EPBBPT4-V001Z	92565
93171579	EPBBPN3-A005Z	90934
93171659	EPBBPN3-A020Z	91829
93177414	EPBMBN3-V001Z	92099
93190052	EPBMBN3-V001Z	92099
93192107	EPBMPN3-V017Z	91253
93194115	EPBMBN3-V001Z	92099
93194419	EPBMPN3-V026Z	94423
93198487	EPBMPN3-V001Z	90037
93198753	EPBBPN3-V007Z	97073
93232415	EPBMPT4-V043Z	97765
93342430	EPBBPT4-V005Z	93700
93399801	EPBMPT4-V038Z	94727
93857938	EPBBPN3-V007Z	97073
95512846	EPBMPT4-V003Z	93266
96276354	EPBMPN3-V011Z	94242
96325870	EPBMPN3-V021Z	92226
96330547	EPBMPN3-V011Z	94242
96333468	EPBMPN3-V042Z	92659
96482570	EPBMPN3-V018Z	97066
97180655	EPBMPN3-V006Z	97501
97287868	EPBBPN3-V010Z	95936
97381191	EPBMBT4-A002Z	92144
CHERY	→ NTK	Stock
465Q1AD1100800	EPBMPT4-D025Z	92358
480ED1008060	EPBMPT4-V038Z	94727
480EE1008060	EPBMPT4-V043Z	97765
LR021587	EPBBPT4-V009Z	95675
S213614021	EPBMPT4-V003Z	93266
CHEVROLET	→ NTK	Stock
1235046	EPBMPN3-V005Z	93871
9109593	EPBMBN3-V001Z	92099
9109787	EPBMPT4-V029Z	90509
9117763	EPBMPN3-A028Z	93480
9160331	EPBMPN3-A033Z	96422
9197948	EPBBPT4-V021Z	97219
9389131	EPBMPN3-A003Z	92477
12568929	EPBMPT4-V003Z	93266
12569240	EPBMPN3-A003Z	92477
12569241	EPBMPN3-A033Z	96422



CHEVROLET	→ NTK	Stock
12575467	EPBMPN3-V010Z	93991
12591290	EPBMPN3-V017Z	91253
12592017	EPBMBT4-V004Z	96629
12594942	EPBMPN3-V017Z	91253
12614970	EPBMPN3-V005Z	93871
12644228	EPBMPN3-V017Z	91253
12788793	EPBMPT4-V026Z	91770
16040609	EPBMPN3-A033Z	96422
16137039	EPBMPN3-A003Z	92477
16153989	EPBBPN3-A026Z	96088
16172899	EPBBPN3-A025Z	97101
16212460	EPBMPN3-V005Z	93871
16235939	EPBMPN3-V006Z	97501
16255839	EPBMPN3-V013Z	94788
16258659	EPBMPN3-V005Z	93871
24420587	EPBMPN3-V010Z	93991
24420761	EPBBPN3-A012Z	91308
25184080	EPBMPN3-V011Z	94242
25184081	EPBMPN3-V018Z	97066
25184083	EPBMPN3-V021Z	92226
25184087	EPBMPN3-V042Z	92659
28074365	EPBMPN3-V005Z	93871
55206797	EPBBPT4-V001Z	92565
55219294	EPBMBN3-V001Z	92099
55219298	EPBBPT4-V001Z	92565
55563262	EPBBPT4-V021Z	97219
55563267	EPBMPT4-V026Z	91770
55563375	EPBMPN3-V041Z	92257
55567257	EPBBPN3-V029Z	92983
55568175	EPBBPT4-V001Z	92565
55573248	EPBMPN3-V017Z	91253
55576223	EPBBPT4-V010Z	91257
90063543	EPBMPN3-V005Z	93871
90467558	EPBBPN3-A013Z	95023
90541409	EPBBPN3-A015Z	96911
91167213	EPBBPN3-V008Z	90842
93168455	EPBBPN3-V016Z	92713
93170309	EPBBPT4-V010Z	91257
93171176	EPBBPT4-V001Z	92565
93171579	EPBBPN3-A005Z	90934
93171659	EPBBPN3-A020Z	91829
93177414	EPBMBN3-V001Z	92099
93190052	EPBMBN3-V001Z	92099
93192107	EPBMPN3-V017Z	91253
93194115	EPBMBN3-V001Z	92099
93194419	EPBMPN3-V026Z	94423
93198487	EPBMPN3-V001Z	90037
93198753	EPBBPN3-V007Z	97073
93232415	EPBMPT4-V043Z	97765
93342430	EPBBPT4-V005Z	93700
93399801	EPBMPT4-V038Z	94727
93857938	EPBBPN3-V007Z	97073

CHEVROLET	→ NTK	Stock
94705196	EPBMPT4-V038Z	94727
95512846	EPBMPT4-V003Z	93266
96276354	EPBMPN3-V011Z	94242
96325870	EPBMPN3-V021Z	92226
96330547	EPBMPN3-V018Z	97066
96330547	EPBMPN3-V011Z	94242
96333468	EPBMPN3-V042Z	92659
96482570	EPBMPN3-V018Z	97066
97180655	EPBMPN3-V006Z	97501
97287868	EPBBPN3-V010Z	95936
97381191	EPBMBT4-A002Z	92144
CHRYSLER	→ NTK	Stock
5269565	EPBMPT4-V044Z	96079
55219298	EPBBPT4-V001Z	92565
71775581	EPBBPN3-A011Z	91149
00K68066040AA	EPBBPN3-A011Z	91149
00K68141820AA	EPBBPT4-V001Z	92565
00K68153918AA	EPBBPT4-V001Z	92565
045962101F	EPBBPT4-V001Z	92565
05293985AA	EPBMPT4-V044Z	96079
45962101F	EPBBPT4-V001Z	92565
5101120AA	EPBMPN3-A004Z	90833
5101120AB	EPBMPN3-A004Z	90833
5293985AA	EPBMPT4-V044Z	96079
56044591AA	EPBMPN3-A004Z	90833
68066040AA	EPBBPN3-A011Z	91149
68141820AA	EPBBPT4-V001Z	92565
68153918AA	EPBBPT4-V001Z	92565
K05101120AA	EPBMPN3-A004Z	90833
K05101120AB	EPBMPN3-A004Z	90833
K56044591AA	EPBMPN3-A004Z	90833
K68066040AA	EPBBPN3-A011Z	91149
CITROËN	→ NTK	Stock
163639	EPBBPT4-V001Z	92565
163661	EPBBPT4-V001Z	92565
192045	EPBMPN3-A003Z	92477
457403	EPBMPN3-A020Z	96725
457405	EPBMPN3-A020Z	96725
467680	EPBMPT4-A001Z	93136
594607	EPBMPN3-A003Z	92477
594609	EPBMPN3-A003Z	92477
96092693	EPBMPN3-A002Z	96249
96107893	EPBMPN3-A027Z	90915
96195593	EPBBPN3-A028Z	93277
96354934	EPBMPN3-A020Z	96725
96365830	EPBMPT4-A001Z	93136
96394191	EPBMPN3-A020Z	96725
9619114980	EPBBPN3-A027Z	92471
9631716680	EPBBPN3-A003Z	91268
9635493480	EPBMPN3-A020Z	96725
9639027480	EPBBPN3-A001Z	94263
9639381480	EPBMPT4-A001Z	93136

CITROËN	→ NTK	Stock
9639418880	EPBMPN3-A007Z	96754
9639418980	EPBMPN3-A020Z	96725
9639469280	EPBBPN3-A001Z	94263
9642789980	EPBBPN3-A006Z	91736
9649396580	EPBBPN3-A018Z	95753
9651931280	EPBBPN3-A017Z	95311
9660603480	EPBBPT4-A011Z	94601
9663480880	EPBMBT4-A003Z	93024
9675379580	EPBMPN3-V019Z	93061
9805500380	EPBMBT4-A003Z	93024
1563J4	EPBMPN3-A002Z	96249
19200E	EPBMPN3-A009Z	92952
19201K	EPBMPN3-A007Z	96754
19203L	EPBBPN3-A022Z	92949
19204S	EPBMPN3-A003Z	92477
19207T	EPBBPN3-A003Z	91268
19209H	EPBMPN3-A009Z	92952
1920AC	EPBMPN3-A020Z	96725
1920AJ	EPBMPT4-A001Z	93136
1920AN	EPBMPN3-A007Z	96754
1920CZ	EPBBPN3-A001Z	94263
1920FC	EPBMPN3-A003Z	92477
1920GH	EPBBPN3-A006Z	91736
1920J7	EPBMPN3-A002Z	96249
1920K8	EPBMPN3-A027Z	90915
1920KN	EPBMPT4-A030Z	96501
1920KZ	EPBBPN3-A024Z	91449
1920LA	EPBBPT4-A011Z	94601
1920LG	EPBBPN3-A018Z	95753
1920LH	EPBBPN3-A017Z	95311
1920LW	EPBMPT4-A006Z	96115
1920P2	EPBMPN3-A035Z	92810
1920QR	EPBMBT4-A003Z	93024
1920SS	EPBBPT4-V001Z	92565
1920X0	EPBBPN3-A027Z	92471
1922R6	EPBBPT4-A016Z	95268
1922W0	EPBBPN3-V030Z	94092
967783578A	EPBBPN3-V030Z	94092
V759990780	EPBBPN3-V030Z	94092
CITROËN/PEUGEOT	→ NTK	Stock
1920LW	EPBMPT4-A006Z	96115
V753981180	EPBMPT4-A006Z	96115
DACIA	→ NTK	Stock
7700101762	EPBMPN3-V001Z	90037
7700106644	EPBMPN3-V005Z	93871
7700106886	EPBMPN3-V013Z	94788
7700111957	EPBBPN3-V008Z	90842
7700267701	EPBMPN3-A033Z	96422
7700706876	EPBMPN3-A003Z	92477
7701062395	EPBBPN3-V016Z	92713
8200105165	EPBMPN3-V001Z	90037
8200121800	EPBMPN3-V001Z	90037

DACIA	→ NTK	Stock
8200155613	EPBMBN3-V001Z	92099
8200168253	EPBBPN3-V007Z	97073
8200194432	EPBMPT4-V029Z	90509
8200225971	EPBBPN3-V014Z	96895
8200233831	EPBBPN3-V019Z	95201
8200292433	EPBBPN3-V016Z	92713
8200375080	EPBBPN4-V004Z	93057
8200375977	EPBBPN4-V004Z	93057
8200685363	EPBBPN3-V016Z	92713
8200719629	EPBMPN3-V001Z	90037
8200843680	EPBBPN3-V007Z	97073
8933000153	EPBMPN3-A003Z	92477
9618261580	EPBMPN3-A009Z	92952
9631813680	EPBMPN3-A007Z	96754
9639418880	EPBMPN3-A007Z	96754
9639418980	EPBMPN3-A020Z	96725
223650001R	EPBBPN3-V007Z	97073
223650002R	EPBBPT4-V001Z	92565
223650754R	EPBBPN4-V004Z	93057
223653394R	EPBBPN3-V016Z	92713
223653795R	EPBMBN3-V001Z	92099
223657266R	EPBBPN3-V014Z	96895
223658143R	EPBMPT4-V029Z	90509
223658570R	EPBBPN3-V019Z	95201
H8200197927	EPBMPT4-V029Z	90509
DAEWOO	→ NTK	Stock
1235046	EPBMPN3-V005Z	93871
9109593	EPBMBN3-V001Z	92099
9109787	EPBMPT4-V029Z	90509
9117763	EPBMPN3-A028Z	93480
9160331	EPBMPN3-A033Z	96422
9197948	EPBBPT4-V021Z	97219
9389131	EPBMPN3-A003Z	92477
12568929	EPBMPT4-V003Z	93266
12569240	EPBMPN3-A003Z	92477
12569241	EPBMPN3-A033Z	96422
12575467	EPBMPN3-V010Z	93991
12591290	EPBMPN3-V017Z	91253
12592017	EPBMBT4-V004Z	96629
12614970	EPBMPN3-V005Z	93871
12644228	EPBMPN3-V017Z	91253
12788793	EPBMPT4-V026Z	91770
16040609	EPBMPN3-A033Z	96422
16137039	EPBMPN3-A003Z	92477
16153989	EPBBPN3-A026Z	96088
16172899	EPBBPN3-A025Z	97101
16212460	EPBMPN3-V005Z	93871
16235939	EPBMPN3-V006Z	97501
16255839	EPBMPN3-V013Z	94788
16258659	EPBMPN3-V005Z	93871
24420587	EPBMPN3-V010Z	93991
24420761	EPBBPN3-A012Z	91308



DAEWOO	→ NTK	Stock
25184080	EPBMPN3-V011Z	94242
25184087	EPBMPN3-V042Z	92659
28074365	EPBMPN3-V005Z	93871
55206797	EPBBPT4-V001Z	92565
55219294	EPBMBN3-V001Z	92099
55219298	EPBBPT4-V001Z	92565
55563262	EPBBPT4-V021Z	97219
55563267	EPBMPT4-V026Z	91770
55563375	EPBMPN3-V041Z	92257
55567257	EPBBPN3-V029Z	92983
55568175	EPBBPT4-V001Z	92565
55573248	EPBMPN3-V017Z	91253
55576223	EPBBPT4-V010Z	91257
90063543	EPBMPN3-V005Z	93871
90467558	EPBBPN3-A013Z	95023
90541409	EPBBPN3-A015Z	96911
91167213	EPBBPN3-V008Z	90842
93168455	EPBBPN3-V016Z	92713
93170309	EPBBPT4-V010Z	91257
93171176	EPBBPT4-V001Z	92565
93171579	EPBBPN3-A005Z	90934
93171659	EPBBPN3-A020Z	91829
93177414	EPBMBN3-V001Z	92099
93190052	EPBMBN3-V001Z	92099
93192107	EPBMPN3-V017Z	91253
93194115	EPBMBN3-V001Z	92099
93194419	EPBMPN3-V026Z	94423
93198487	EPBMPN3-V001Z	90037
93198753	EPBBPN3-V007Z	97073
93232415	EPBMPT4-V043Z	97765
93342430	EPBBPT4-V005Z	93700
93399801	EPBMPT4-V038Z	94727
93857938	EPBBPN3-V007Z	97073
95512846	EPBMPT4-V003Z	93266
96276354	EPBMPN3-V011Z	94242
96325870	EPBMPN3-V021Z	92226
96330547	EPBMPN3-V011Z	94242
96333468	EPBMPN3-V042Z	92659
96482570	EPBMPN3-V018Z	97066
97180655	EPBMPN3-V006Z	97501
97287868	EPBBPN3-V010Z	95936
97381191	EPBMBT4-A002Z	92144
DAF	→ NTK	Stock
1378484	EPBBPN3-A022Z	92949
1378484	EPBBPN3-A028Z	93277
1815764	EPBBPN3-A028Z	93277
DAIHATSU	→ NTK	Stock
8942126030	EPBMPN3-V025Z	94855
8942152010	EPBMPT4-A030Z	96501
8942197401	EPBMPN3-V025Z	94855
8942097209000	EPBMPT4-A017Z	96798
8942197401000	EPBMPN3-V025Z	94855

DAIHATSU	→ NTK	Stock
89421B1010	EPBMPN3-V025Z	94855
89421B1010000	EPBMPN3-V025Z	94855
DAIMLER	→ NTK	Stock
AJ812337	EPBMPT4-A007Z	96755
AJ85329	EPBMPT4-A007Z	96755
DODGE	→ NTK	Stock
5269565	EPBMPT4-V044Z	96079
55219298	EPBBPT4-V001Z	92565
5101120AB	EPBMPN3-A004Z	90833
5149203AA	EPBMPN3-A004Z	90833
5293985AA	EPBMPT4-V044Z	96079
56044591AA	EPBMPN3-A004Z	90833
K05101120AB	EPBMPN3-A004Z	90833
K05149203AA	EPBMPN3-A004Z	90833
K56044591AA	EPBMPN3-A004Z	90833
DS	→ NTK	Stock
1701	EPBMPN3-A003Z	92477
1703	EPBMPT4-V003Z	93266
1704	EPBMPT4-V043Z	97765
1705	EPBMPT4-D025Z	92358
1706	EPBMPT4-D005Z	93653
1710	EPBMPN3-A002Z	96249
1715	EPBMPT4-A001Z	93136
1718	EPBMPT4-A017Z	96798
1724	EPBBPT4-V001Z	92565
1726	EPBBPT4-V005Z	93700
1728	EPBBPT4-V002Z	95912
1729	EPBBPT4-V003Z	91742
1730	EPBBPN3-V014Z	96895
1920KZ	EPBBPN3-A024Z	91449
1920QR	EPBMBT4-A003Z	93024
1922R6	EPBBPT4-A016Z	95268
FERRARI	→ NTK	Stock
272880	EPBBPT4-V001Z	92565
282849	EPBMBN3-V001Z	92099
7084986	EPBMPT4-V003Z	93266
7696064	EPBMPN3-A003Z	92477
7714662	EPBMPN3-A002Z	96249
7750716	EPBMPN3-A043Z	92940
46451792	EPBMPT4-V012Z	91940
46468682	EPBBPN3-V034Z	96381
46474585	EPBMPT4-V032Z	96108
46531222	EPBMPN3-A002Z	96249
46533518	EPBMPT4-V003Z	93266
46553045	EPBMPT4-V003Z	93266
46769978	EPBBPT4-V010Z	91257
46769979	EPBMPN3-V022Z	91412
46811235	EPBMBN3-V001Z	92099
55206796	EPBMBN3-V001Z	92099
55206797	EPBBPT4-V001Z	92565
55209037	EPBMPT4-V003Z	93266
55209194	EPBBPN3-V007Z	97073

FERRARI	→ NTK	Stock
55219294	EPBMBN3-V001Z	92099
55219295	EPBBPN3-V007Z	97073
55219298	EPBBPT4-V001Z	92565
60809804	EPBMPN3-A043Z	92940
60811067	EPBMPN3-A002Z	96249
60811534	EPBMPN3-A003Z	92477
60814507	EPBMPN3-A002Z	96249
71714218	EPBMPT4-V012Z	91940
71718233	EPBMPT4-V012Z	91940
71718678	EPBMPT4-V012Z	91940
71728656	EPBMPT4-V012Z	91940
71732447	EPBMPT4-V003Z	93266
71739292	EPBMPN3-V005Z	93871
71741115	EPBMPN3-V010Z	93991
71742176	EPBMPN3-V031Z	92481
73503657	EPBBPT4-V001Z	92565
77363792	EPBMPN3-V022Z	91412
77364145	EPBMPT4-V003Z	93266
77364543	EPBBPT4-V010Z	91257
77364869	EPBMPT4-V003Z	93266
77365393	EPBBPT4-V001Z	92565
77366837	EPBMPT4-V028Z	93902
500309838	EPBMPN3-A002Z	96249
500351377	EPBBPT4-V005Z	93700
504064370	EPBBPT4-V010Z	91257
504088431	EPBBPT4-V001Z	92565
504245257	EPBBPT4-V001Z	92565
552182980	EPBBPT4-V001Z	92565
9609992380	EPBMPN3-A002Z	96249
9618261580	EPBMPN3-A009Z	92952
9619114980	EPBBPN3-A027Z	92471
9631716680	EPBBPN3-A003Z	91268
9631813680	EPBMPN3-A007Z	96754
9639381480	EPBMPT4-A001Z	93136
9639418880	EPBMPN3-A007Z	96754
9639418980	EPBMPN3-A020Z	96725
9639469280	EPBBPN3-A001Z	94263
9642789980	EPBBPN3-A006Z	91736
9649396580	EPBBPN3-A018Z	95753
9651931280	EPBBPN3-A017Z	95311
9660603480	EPBBPT4-A011Z	94601
9663480880	EPMBT4-A003Z	93024
FIAT	→ NTK	Stock
272880	EPBBPT4-V001Z	92565
283538	EPBBPN3-V007Z	97073
7084986	EPBMPT4-V003Z	93266
7696064	EPBMPN3-A003Z	92477
7714662	EPBMPN3-A002Z	96249
7750716	EPBMPN3-A043Z	92940
46451792	EPBMPT4-V012Z	91940
46468682	EPBBPN3-V034Z	96381
46474585	EPBMPT4-V032Z	96108

FIAT	→ NTK	Stock
46531222	EPBMPN3-A002Z	96249
46533518	EPBMPT4-V003Z	93266
46553045	EPBMPT4-V003Z	93266
46769978	EPBBPT4-V010Z	91257
46769979	EPBMPN3-V022Z	91412
46811235	EPBMBN3-V001Z	92099
55206796	EPBMBN3-V001Z	92099
55206797	EPBBPT4-V001Z	92565
55209037	EPBMPT4-V003Z	93266
55209194	EPBBPN3-V007Z	97073
55219294	EPBMBN3-V001Z	92099
55219295	EPBBPN3-V007Z	97073
55219298	EPBBPT4-V001Z	92565
55221402	EPBMPT4-V012Z	91940
55238125	EPBBPT4-V010Z	91257
60809804	EPBMPN3-A043Z	92940
60811067	EPBMPN3-A002Z	96249
60811534	EPBMPN3-A003Z	92477
60814507	EPBMPN3-A002Z	96249
71714218	EPBMPT4-V012Z	91940
71718233	EPBMPT4-V012Z	91940
71718678	EPBMPT4-V012Z	91940
71728656	EPBMPT4-V012Z	91940
71732447	EPBMPT4-V003Z	93266
71739292	EPBMPN3-V005Z	93871
71741115	EPBMPN3-V010Z	93991
71742176	EPBMPN3-V031Z	92481
71775581	EPBBPN3-A011Z	91149
73503657	EPBBPT4-V001Z	92565
77363792	EPBMPN3-V022Z	91412
77364145	EPBMPT4-V003Z	93266
77364146	EPBMPN3-V022Z	91412
77364543	EPBBPT4-V010Z	91257
77364869	EPBMPT4-V003Z	93266
77365393	EPBBPT4-V001Z	92565
77366191	EPBBPT4-V010Z	91257
77366837	EPBMPT4-V028Z	93902
99455421	EPBBPT4-V012Z	96542
500309838	EPBMPN3-A002Z	96249
500351377	EPBBPT4-V005Z	93700
504064370	EPBBPT4-V010Z	91257
504088431	EPBBPT4-V001Z	92565
504245257	EPBBPT4-V001Z	92565
504369148	EPBBPT4-V001Z	92565
552182980	EPBBPT4-V001Z	92565
9609992380	EPBMPN3-A002Z	96249
9618261580	EPBMPN3-A009Z	92952
9619114980	EPBBPN3-A027Z	92471
9631716680	EPBBPN3-A003Z	91268
9631813680	EPBMPN3-A007Z	96754
9639381480	EPBMPT4-A001Z	93136
9639418880	EPBMPN3-A007Z	96754

FIAT	→ NTK	Stock
9639418980	EPBMPN3-A020Z	96725
9639469280	EPBBPN3-A001Z	94263
9642789980	EPBBPN3-A006Z	91736
9649396580	EPBBPN3-A018Z	95753
9651931280	EPBBPN3-A017Z	95311
9660603480	EPBBPT4-A011Z	94601
9663480880	EPBMBT4-A003Z	93024
S8100181	EPBBPN3-V007Z	97073
S8100182	EPBBPN3-V007Z	97073
FORD	→ NTK	Stock
1023008	EPBBPN3-A032Z	96503
1041355	EPBBPN3-A022Z	92949
1041954	EPBBPN3-A031Z	95922
1041954	EPBMPN3-V008Z	90549
1086439	EPBMPT4-A036Z	97175
1087424	EPBMPT4-A036Z	97175
1110963	EPBMPT4-V037Z	92354
1111222	EPBMBT4-D001Z	91628
1113276	EPBMPT4-V015Z	95488
1119939	EPBMPT4-A017Z	96798
1127268	EPBBPN3-A031Z	95922
1127268	EPBMPN3-V008Z	90549
1136735	EPBBPT4-V003Z	91742
1139330	EPBBPN3-A031Z	95922
1141598	EPBMPT4-A007Z	96755
1144420	EPBBPN3-A031Z	95922
1144809	EPBMPN3-A003Z	92477
1209552	EPBBPT4-V002Z	95912
1223690	EPBMPN4-A034Z	95507
1231463	EPBBPN3-A001Z	94263
1256481	EPBBPN3-A001Z	94263
1319285	EPBMPN4-A035Z	96317
1330116	EPBBPT4-A017Z	92559
1333353	EPBBPN3-A006Z	91736
1338678	EPBBPN3-V021Z	95679
1352477	EPBBPN3-V021Z	95679
1367813	EPBBPT4-V013Z	91803
1372511	EPBBPT4-A011Z	94601
1379704	EPBBPT4-V009Z	95675
1427942	EPBBPN3-A018Z	95753
1438809	EPBBPN3-A018Z	95753
1439251	EPBMPN4-A035Z	96317
1439900	EPBMPT4-A017Z	96798
1446702	EPBMPN4-A035Z	96317
1448387	EPBBPT4-V001Z	92565
1468879	EPBBPN3-A001Z	94263
1478729	EPBMPN4-A034Z	95507
1490907	EPBMPT4-A007Z	96755
1503280	EPBBPT4-A011Z	94601
1516717	EPBMPT4-A020Z	97897
1539497	EPBMBN3-V001Z	92099
1562724	EPBMPT4-V003Z	93266

FORD	→ NTK	Stock
1580533	EPBMPT4-V003Z	93266
1638311	EPBBPN3-A033Z	96394
1648138	EPBMPN3-D029Z	95772
1682141	EPBMPN3-V019Z	93061
1683949	EPBMBT4-A003Z	93024
1689133	EPBBPT4-V009Z	95675
1703244	EPBBPN3-A017Z	95311
1721462	EPBMBN3-V001Z	92099
1723819	EPBBPT4-V001Z	92565
1762251	EPBMPN3-V019Z	93061
1796446	EPBMBT4-A003Z	93024
1827054	EPBMPT4-V002Z	94153
1852633	EPBMPT4-V028Z	93902
1871255	EPBMPT4-V028Z	93902
1871255	EPBBPT4-V001Z	92565
1879414	EPBMPT4-V015Z	95488
1913600	EPBMPN3-V019Z	93061
1923995	EPBMPT4-A007Z	96755
2207410	EPBMPT4-V002Z	94153
4138350	EPBMPT4-V002Z	94153
4449664	EPBBPN3-A031Z	95922
5094154	EPBBPT4-V001Z	92565
6582335	EPBBPN3-A026Z	96088
6742049	EPBMPN3-A043Z	92940
1C1A9F479AA	EPBMPT4-V002Z	94153
1C1Y9F479AA	EPBMPN3-A003Z	92477
1M5F9S428AA	EPBBPN3-A031Z	95922
1M5F9S428AB	EPBBPN3-A031Z	95922
1S4A9F479BA	EPBMPT4-V015Z	95488
1S7A9F479AB	EPBMPT4-A017Z	96798
1S7A9F479AC	EPBMPT4-A017Z	96798
1S7Z9F479ACFC	EPBMPT4-A017Z	96798
2S6A9F479BA	EPBMPT4-A007Z	96755
2S6A9F479BB	EPBMPT4-A007Z	96755
2S6A9F479BC	EPBMPT4-A007Z	96755
2S6A9F479CB	EPBMPT4-A020Z	97897
2S6Q12T551AA	EPBBPN3-A006Z	91736
2S7G9F479AA	EPBMPN4-A034Z	95507
2S7G9F479AB	EPBMPN4-A034Z	95507
3M219E928AA	EPBBPT4-V002Z	95912
3M5A12T551AA	EPBBPN3-A001Z	94263
3M5A12T551AB	EPBBPN3-A001Z	94263
3M5A12T551AC	EPBBPN3-A001Z	94263
3R239F479AA	EPBBPT4-V005Z	93700
3U1L9F479AA	EPBBPT4-V005Z	93700
4M519F479AA	EPBBPN3-V021Z	95679
4M5Q9S428AA	EPBBPN3-V021Z	95679
4S4G9F479AA	EPBMPN4-A035Z	96317
4S4G9F479AB	EPBMPN4-A035Z	96317
4S4G9F479AC	EPBMPN4-A035Z	96317
4S7Q9F479AA	EPBBPT4-A017Z	92559
6C119F479AA	EPBBPT4-A011Z	94601

FORD	→ NTK	Stock
6C119F479AB	EPBBPT4-A011Z	94601
6G9N12B676AA	EPBBPT4-V009Z	95675
6G9N12B676AB	EPBBPT4-V009Z	95675
6G9Q9F479AA	EPBBPN3-A018Z	95753
6G9Q9F479AB	EPBBPN3-A018Z	95753
6M349J433AA	EPBBPT4-V001Z	92565
6M5Y9F479AA	EPBBPT4-V013Z	91803
8X239S428AA	EPBBPN3-A031Z	95922
92VB9F479AA	EPBBPN3-A026Z	96088
97VB9F479BA	EPBBPN3-A032Z	96503
98AB9F479BA	EPBMPN3-V008Z	90549
98AB9S428AB	EPBBPN3-A031Z	95922
98AB9S428AB	EPBMPN3-V008Z	90549
99VW9E928AA	EPBMBT4-D001Z	91628
99VW9E928AB	EPBBPT4-V003Z	91742
9S519J559AA	EPBMBN3-V001Z	92099
9S519J559BA	EPBMPT4-V003Z	93266
9S519J559BB	EPBMPT4-V003Z	93266
AG919F479AA	EPBMPN3-V019Z	93061
AG919F479AB	EPBMPN3-V019Z	93061
AG919F479AC	EPBMPN3-V019Z	93061
AV2Q12T551AA	EPBBPN3-A017Z	95311
AV6Q12B676AA	EPBMBT4-A003Z	93024
AV6Q12B676BA	EPBMBT4-A003Z	93024
BA9F479A	EPBBPT4-V005Z	93700
BS519J559AA	EPBMBN3-V001Z	92099
BS519J559BA	EPBBPT4-V001Z	92565
BV619F479AA	EPBBPT4-V001Z	92565
CC1A9F479AA	EPBMPT4-V002Z	94153
CC1A9F479AB	EPBMPT4-V002Z	94153
E6EF9F479A2A	EPBMPN3-D029Z	95772
EL8A9F479AA	EPBMPT4-V028Z	93902
EL8A9F479CA	EPBMPT4-V028Z	93902
EL8A9F479CA	EPBBPT4-V001Z	92565
ES4A9F479BA	EPBMPT4-V015Z	95488
HY5312B676AA	EPBBPT4-V001Z	92565
M9101473	EPBBPT4-A011Z	94601
V86BB9F479AA	EPBBPN3-A033Z	96394
V92AB9F479AA	EPBMPN3-A043Z	92940
V97GB9F479AB	EPBBPN3-A022Z	92949
WE0118211	EPBBPT4-V001Z	92565
XS6F9F479AB	EPBMPT4-A036Z	97175
YC159S428AA	EPBBPN3-A031Z	95922
YS6A9F479AA	EPBMPT4-V037Z	92354
FORD USA	→ NTK	Stock
1682141	EPBMPN3-V019Z	93061
1762251	EPBMPN3-V019Z	93061
1871255	EPBMPT4-V028Z	93902
1913600	EPBMPN3-V019Z	93061
AG919F479AA	EPBMPN3-V019Z	93061
AG919F479AB	EPBMPN3-V019Z	93061
AG919F479AC	EPBMPN3-V019Z	93061

FORD USA	→ NTK	Stock
EL8A9F479CA	EPBMPT4-V028Z	93902
GENERAL MOTORS	→ NTK	Stock
1235046	EPBMPN3-V005Z	93871
1235084	EPBBPT4-V001Z	92565
1235258	EPBMBN3-V001Z	92099
3648776	EPBBPN3-V030Z	94092
9109593	EPBMBN3-V001Z	92099
9109787	EPBMPT4-V029Z	90509
9117763	EPBMPN3-A028Z	93480
9160331	EPBMPN3-A033Z	96422
9197948	EPBBPT4-V021Z	97219
9389131	EPBMPN3-A003Z	92477
12568929	EPBMPT4-V003Z	93266
12569240	EPBMPN3-A003Z	92477
12569241	EPBMPN3-A033Z	96422
12575467	EPBMPN3-V010Z	93991
12591290	EPBMPN3-V017Z	91253
12592017	EPBMBT4-V004Z	96629
12594942	EPBMPN3-V017Z	91253
12614970	EPBMPN3-V005Z	93871
12644228	EPBMPN3-V017Z	91253
12788793	EPBMPT4-V026Z	91770
16040609	EPBMPN3-A033Z	96422
16137039	EPBMPN3-A003Z	92477
16153989	EPBBPN3-A026Z	96088
16172899	EPBBPN3-A025Z	97101
16212460	EPBMPN3-V005Z	93871
16235939	EPBMPN3-V006Z	97501
16255839	EPBMPN3-V013Z	94788
16258659	EPBMPN3-V005Z	93871
24420587	EPBMPN3-V010Z	93991
24420761	EPBBPN3-A012Z	91308
25184080	EPBMPN3-V011Z	94242
25184087	EPBMPN3-V042Z	92659
28074365	EPBMPN3-V005Z	93871
28074367	EPBMPN3-V005Z	93871
55206797	EPBBPT4-V001Z	92565
55219294	EPBMBN3-V001Z	92099
55219298	EPBBPT4-V001Z	92565
55238125	EPBBPT4-V010Z	91257
55563262	EPBBPT4-V021Z	97219
55563267	EPBMPT4-V026Z	91770
55563375	EPBMPN3-V041Z	92257
55567257	EPBBPN3-V029Z	92983
55568175	EPBBPT4-V001Z	92565
55573248	EPBMPN3-V017Z	91253
55576223	EPBBPT4-V010Z	91257
90063543	EPBMPN3-V005Z	93871
90467558	EPBBPN3-A013Z	95023
90541409	EPBBPN3-A015Z	96911
91167213	EPBBPN3-V008Z	90842
93168455	EPBBPN3-V016Z	92713

GENERAL MOTORS → NTK		Stock
93170309	EPBBPT4-V010Z	91257
93171176	EPBBPT4-V001Z	92565
93171579	EPBBPN3-A005Z	90934
93171659	EPBBPN3-A020Z	91829
93177414	EPBMBN3-V001Z	92099
93190052	EPBMBN3-V001Z	92099
93192107	EPBMPN3-V017Z	91253
93194115	EPBMBN3-V001Z	92099
93194419	EPBMPN3-V026Z	94423
93198487	EPBMPN3-V001Z	90037
93198753	EPBBPN3-V007Z	97073
93198836	EPBMBN3-V001Z	92099
93232415	EPBMPT4-V043Z	97765
93342430	EPBBPT4-V005Z	93700
93399801	EPBMPT4-V038Z	94727
93450122	EPBBPN3-V014Z	96895
93852290	EPBBPN3-V014Z	96895
93857938	EPBBPN3-V007Z	97073
94705196	EPBMPT4-V038Z	94727
95512846	EPBMPT4-V003Z	93266
95512870	EPBBPT4-V010Z	91257
96276354	EPBMPN3-V011Z	94242
96325870	EPBMPN3-V021Z	92226
96330547	EPBMPN3-V011Z	94242
96333468	EPBMPN3-V042Z	92659
96482570	EPBMPN3-V018Z	97066
97180655	EPBMPN3-V006Z	97501
97287868	EPBBPN3-V010Z	95936
97381191	EPBMBT4-A002Z	92144
98131025	EPBMPN3-V005Z	93871
98131026	EPBMPN3-V006Z	97501
GMC → NTK	Stock	
1235084	EPBBPT4-V001Z	92565
3648776	EPBBPN3-V030Z	94092
12568929	EPBMPT4-V003Z	93266
55206797	EPBBPT4-V001Z	92565
55219298	EPBBPT4-V001Z	92565
93232415	EPBMPT4-V043Z	97765
GREAT WALL → NTK	Stock	
3611080G01	EPBMPT4-V038Z	94727
HARLEY-DAVIDSON MC → NTK	Stock	
3231907	EPBMPT4-V003Z	93266
3242495	EPBMPN3-A002Z	96249
HOLDEN → NTK	Stock	
16017460	EPBMPN3-A003Z	92477
16137039	EPBMPN3-A003Z	92477
8161370390	EPBMPN3-A003Z	92477
HONDA → NTK	Stock	
37830P05A01	EPBMPN3-R012Z	96590
37830P0GS00	EPBMPN3-R012Z	96590
37830P13003	EPBMPN3-R046Z	95625
37830P5TG00	EPBBPN3-A022Z	92949

HONDA → NTK		Stock
37830P7AN11	EPBMPN3-R012Z	96590
37830PAAS00	EPBMPN3-R012Z	96590
37830PDDX00	EPBBPN3-A028Z	93277
37830PDFE01	EPBMPN3-A034Z	92094
37830PGKA01	EPBMPN3-A015Z	94611
37830PHM003	EPBMPN3-R046Z	95625
37830PLZD00	EPBBPN3-V010Z	95936
37830PNC003	EPBMPN3-A015Z	94611
37830PWEG01	EPBMPT4-V038Z	94727
37830RBDE011M4	EPBBPT4-V001Z	92565
37830RBDE012M4	EPBBPT4-V001Z	92565
37830RBDE013	EPBBPT4-V001Z	92565
37830RBDE013M4	EPBBPT4-V001Z	92565
37830RBDE014	EPBBPT4-V001Z	92565
HYUNDAI → NTK	Stock	
3920027000	EPBBPN3-V023Z	90603
3920027400	EPBBPT4-V007Z	94941
3920042020	EPBBPT4-V007Z	94941
3920042030	EPBBPT4-V007Z	94941
3930003000	EPBMPT4-V018Z	95148
3930022600	EPBMPT4-V039Z	96769
3930038100	EPBMPN3-V030Z	92953
3930038110	EPBMPT4-V039Z	96769
3930038120	EPBMPT4-V039Z	96769
3930038200	EPBMPN3-V030Z	92953
3930084400	EPBMPT4-V014Z	97115
3933024750	EPBMPN3-A003Z	92477
3933026300	EPBMPT4-V043Z	97765
0K30E18211A	EPBMPT4-V033Z	90173
0K95018211	EPBMPN3-A003Z	92477
392002A650	EPBMPT4-V031Z	94763
393002A600	EPBMBN3-V006Z	94835
393002B000	EPBMPT4-V018Z	95148
393002B050	EPBMBN3-V006Z	94835
393002B100	EPBMPT4-V018Z	95148
393002E600	EPBMPT4-V018Z	95148
393002G000	EPBMPT4-V014Z	97115
INFINITI → NTK	Stock	
223650001R	EPBBPN3-V007Z	97073
2236500QAA	EPBMBN3-V001Z	92099
2236500QAB	EPBBPN3-V008Z	90842
223655X20A	EPBBPN3-V016Z	92713
223657266R	EPBBPN3-V014Z	96895
22365AX000	EPBMPT4-V016Z	92071
22365AX00A	EPBMPT4-V016Z	92071
22365BC400	EPBBPN3-V007Z	97073
22365BN701	EPBMBN3-V001Z	92099
22365EY00C	EPBMPN3-A050Z	96018
22365EY01C	EPBMPN3-A049Z	93927
2263000Q2F	EPBMPT4-V029Z	90509
2263000Q3H	EPBBPN3-V016Z	92713
2373100Q0L	EPBBPN3-V016Z	92713

INFINITI	→ NTK	Stock
2508500Q0A	EPBBPN3-V007Z	97073
2508500Q0B	EPBMPN3-V001Z	90037
2508500Q0C	EPBBPN3-V007Z	97073
2508500QAA	EPBMPN3-V001Z	90037
2508500QAB	EPBMPT4-V029Z	90509
25085AW300	EPBBPN3-V007Z	97073
INNOCENTI	→ NTK	Stock
7714662	EPBMPN3-A002Z	96249
ISEKI	→ NTK	Stock
6281940001	EPBBPT4-V005Z	93700
62819400010A	EPBBPT4-V005Z	93700
ISUZU	→ NTK	Stock
16212460	EPBMPN3-V005Z	93871
8125692410	EPBMPN3-A033Z	96422
8160406090	EPBMPN3-A033Z	96422
8162124600	EPBMPN3-V005Z	93871
8280743650	EPBMPN3-V005Z	93871
IVECO	→ NTK	Stock
46531222	EPBMPN3-A002Z	96249
73503657	EPBMPT4-V028Z	93902
73503657	EPBBPT4-V001Z	92565
99455421	EPBBPT4-V012Z	96542
500303029	EPBBPT4-V001Z	92565
500351377	EPBBPT4-V005Z	93700
504064370	EPBBPT4-V010Z	91257
504088431	EPBBPT4-V001Z	92565
504245257	EPBBPT4-V001Z	92565
504360148	EPBBPT4-V001Z	92565
504360149	EPBBPT4-V001Z	92565
504369148	EPBBPT4-V001Z	92565
5801699032	EPBBPT4-V010Z	91257
JAGUAR	→ NTK	Stock
AJ811668	EPBBPT4-V009Z	95675
AJ812337	EPBMPT4-A007Z	96755
AJ82719	EPBMPT4-V002Z	94153
AJ85329	EPBMPT4-A007Z	96755
C2C29212	EPBBPN3-A031Z	95922
C2G2675	EPBMPN3-V019Z	93061
C2P5434	EPBBPN3-A031Z	95922
C2Z14334	EPBBPN3-A018Z	95753
C2Z4525	EPBBPN3-A031Z	95922
JDE29140	EPBMPN3-V019Z	93061
T2H21415	EPBMPN3-V019Z	93061
JEEP	→ NTK	Stock
55219298	EPBBPT4-V001Z	92565
71775581	EPBBPN3-A011Z	91149
8933000153	EPBMPN3-A003Z	92477
5101120AB	EPBMPN3-A004Z	90833
5149203AA	EPBMPN3-A004Z	90833
56044591AA	EPBMPN3-A004Z	90833
68066040AA	EPBBPN3-A011Z	91149
K05101120AA	EPBMPN3-A004Z	90833

JEEP	→ NTK	Stock
K05101120AB	EPBMPN3-A004Z	90833
K05149203AA	EPBMPN3-A004Z	90833
K56044591AA	EPBMPN3-A004Z	90833
KIA	→ NTK	Stock
3920027000	EPBBPN3-V023Z	90603
3920027400	EPBBPT4-V007Z	94941
3920042020	EPBBPT4-V007Z	94941
3920042030	EPBBPT4-V007Z	94941
3930003000	EPBMPT4-V018Z	95148
3930022600	EPBMPT4-V039Z	96769
3930038100	EPBMPN3-V030Z	92953
3930038110	EPBMPT4-V039Z	96769
3930038120	EPBMPT4-V039Z	96769
3930038200	EPBMPN3-V030Z	92953
3930084400	EPBMPT4-V014Z	97115
3933024750	EPBMPN3-A003Z	92477
3933026300	EPBMPT4-V043Z	97765
0K30E18211A	EPBMPT4-V033Z	90173
0K95018211	EPBMPN3-A003Z	92477
392002A650	EPBMPT4-V031Z	94763
393002A600	EPBMBN3-V006Z	94835
393002B000	EPBMPT4-V018Z	95148
393002B050	EPBMBN3-V006Z	94835
393002B100	EPBMPT4-V018Z	95148
393002E600	EPBMPT4-V018Z	95148
393002G000	EPBMPT4-V014Z	97115
LAMBORGHINI	→ NTK	Stock
36906051	EPBMPT4-V004Z	92899
36906051	EPBMPT4-V004Z	92899
38906051	EPBMBT4-D001Z	91628
38906051	EPBMBT4-D001Z	91628
47906051	EPBMPT4-V022Z	90125
47906051	EPBMPT4-V022Z	90125
59906051	EPBBPT4-V019Z	95582
59906051	EPBBPT4-V019Z	95582
62906051	EPBMBT4-D001Z	91628
279980411	EPBMPT4-V008Z	96201
369980411	EPBMPT4-V004Z	92899
030906051A	EPBMPT4-D025Z	92358
036906051C	EPBMPN4-D019Z	91102
036906051D	EPBMPT4-V004Z	92899
036906051E	EPBMPN4-V040Z	95972
036906051F	EPBMPN4-V041Z	94063
036906051G	EPBMPN4-V013Z	93089
038906051A	EPBBPT4-V015Z	94877
038906051B	EPBBPT4-V003Z	91742
038906051C	EPBBPT4-V002Z	95912
038906051D	EPBBPN4-V014Z	93428
03C906051	EPBMPT4-V008Z	96201
03C906051F	EPBMPT4-V008Z	96201
03D906051	EPBMPT4-V011Z	91119
03D906051A	EPBMPT4-V011Z	91119

LAMBORGHINI	→ NTK	Stock
03G906051D	EPBBPT4-V003Z	91742
03G906051E	EPBBPT4-V002Z	95912
03G906051F	EPBBPT4-V002Z	95912
046130385A	EPBBPN3-A013Z	95023
06B906051	EPBMPT4-D005Z	93653
07C906051	EPBMPT4-D042Z	91710
1K0612041BT	EPBMPN4-V013Z	93089
1K0612041DH	EPBMPN4-V013Z	93089
1K0612041FE	EPBMPN4-V013Z	93089
1K0612041FR	EPBMPN4-V013Z	93089
1K0612041GH	EPBMPN4-V013Z	93089
2E0906051A	EPBMPN3-A004Z	90833
2P0906051	EPBBPT4-V005Z	93700
377906309C	EPBMPN3-A002Z	96249
3A0906051	EPBMPN3-A027Z	90915
5N0612041AH	EPBMPN4-V013Z	93089
6R1612041H	EPBMPN4-V013Z	93089
6R1612041P	EPBMPN4-V013Z	93089
6R2612041AE	EPBMPN4-V013Z	93089
6R2612041J	EPBMPN4-V013Z	93089
6R2612051AE	EPBMPN4-V013Z	93089
7N0612041C	EPBMPN4-V013Z	93089
LANCIA	→ NTK	Stock
272880	EPBBPT4-V001Z	92565
7084986	EPBMPT4-V003Z	93266
7696064	EPBMPN3-A003Z	92477
7714662	EPBMPN3-A002Z	96249
7750716	EPBMPN3-A043Z	92940
46451792	EPBMPT4-V012Z	91940
46468682	EPBBPN3-V034Z	96381
46474585	EPBMPT4-V032Z	96108
46531222	EPBMPN3-A002Z	96249
46533518	EPBMPT4-V003Z	93266
46553045	EPBMPT4-V003Z	93266
46769978	EPBBPT4-V010Z	91257
46769979	EPBMPN3-V022Z	91412
46811235	EPBMBN3-V001Z	92099
55206796	EPBMBN3-V001Z	92099
55206797	EPBBPT4-V001Z	92565
55209037	EPBMPT4-V003Z	93266
55209194	EPBBPN3-V007Z	97073
55219294	EPBMBN3-V001Z	92099
55219295	EPBBPN3-V007Z	97073
55219298	EPBBPT4-V001Z	92565
55238125	EPBBPT4-V010Z	91257
60809804	EPBMPN3-A043Z	92940
60811067	EPBMPN3-A002Z	96249
60811534	EPBMPN3-A003Z	92477
60814507	EPBMPN3-A002Z	96249
71714218	EPBMPT4-V012Z	91940
71718233	EPBMPT4-V012Z	91940
71718678	EPBMPT4-V012Z	91940

LANCIA	→ NTK	Stock
71728656	EPBMPT4-V012Z	91940
71732447	EPBMPT4-V003Z	93266
71739292	EPBMPN3-V005Z	93871
71741115	EPBMPN3-V010Z	93991
71742176	EPBMPN3-V031Z	92481
73503657	EPBBPT4-V001Z	92565
77363792	EPBMPN3-V022Z	91412
77364145	EPBMPT4-V003Z	93266
77364543	EPBBPT4-V010Z	91257
77364869	EPBMPT4-V003Z	93266
77365393	EPBBPT4-V001Z	92565
77366191	EPBBPT4-V010Z	91257
77366837	EPBMPT4-V028Z	93902
500309838	EPBMPN3-A002Z	96249
500351377	EPBBPT4-V005Z	93700
504064370	EPBBPT4-V010Z	91257
504088431	EPBBPT4-V001Z	92565
504245257	EPBBPT4-V001Z	92565
552182980	EPBBPT4-V001Z	92565
9609992380	EPBMPN3-A002Z	96249
9618261580	EPBMPN3-A009Z	92952
9619114980	EPBBPN3-A027Z	92471
9631716680	EPBBPN3-A003Z	91268
9631813680	EPBMPN3-A007Z	96754
9639381480	EPBMPT4-A001Z	93136
9639418880	EPBMPN3-A007Z	96754
9639418980	EPBMPN3-A020Z	96725
9639469280	EPBBPN3-A001Z	94263
9642789980	EPBBPN3-A006Z	91736
9649396580	EPBBPN3-A018Z	95753
9651931280	EPBBPN3-A017Z	95311
9660603480	EPBBPT4-A011Z	94601
9663480880	EPBMBT4-A003Z	93024
LAND ROVER	→ NTK	Stock
1141598	EPBMPT4-A007Z	96755
9H2Q9V442AC	EPBMPN3-A051Z	92149
ERR3561	EPBBPN3-A013Z	95023
LR001324	EPBBPN3-A018Z	95753
LR008887	EPBBPT4-V009Z	95675
LR008935	EPBMPT4-A007Z	96755
LR014386	EPBMPN3-A051Z	92149
LR021587	EPBBPT4-V009Z	95675
LR022157	EPBMPN3-V019Z	93061
LR038762	EPBMPN3-V019Z	93061
LR075167	EPBMPN3-V019Z	93061
MHK100410L	EPBBPN3-A028Z	93277
MHK100640	EPBBPT4-V012Z	96542
MHK100820L	EPBMPT4-V009Z	96309
MHK101060L	EPBBPN3-A005Z	90934
MHK101190	EPBBPN3-A028Z	93277
WKW000060	EPBBPN3-A020Z	91829

LEXUS	→ NTK	Stock
8942012210	EPBMBN3-V004Z	90962
8942012220	EPBMBN3-V004Z	90962
8942012230	EPBMPN3-V025Z	94855
8942012250	EPBMPN3-V025Z	94855
8942074010	EPBMPN3-V025Z	94855
8942120190	EPBMPN3-V025Z	94855
8942120200	EPBMBN3-V005Z	90946
8942126030	EPBMPN3-V025Z	94855
8942137010	EPBMPN3-V025Z	94855
8942137030	EPBMPN3-V025Z	94855
8942147010	EPBMPN4-A023Z	91984
8942152010	EPBMPT4-A030Z	96501
8942171020	EPBMBN3-V004Z	90962
8942171030	EPBMBN3-V005Z	90946
89420WA010	EPBMBN3-V002Z	94886
SU00100645	EPBBPN3-A006Z	91736
MARUTI	→ NTK	Stock
18590M53500	EPBMPT4-V038Z	94727
MASERATI	→ NTK	Stock
272880	EPBBPT4-V001Z	92565
7084986	EPBMPT4-V003Z	93266
7696064	EPBMPN3-A003Z	92477
7714662	EPBMPN3-A002Z	96249
7750716	EPBMPN3-A043Z	92940
46451792	EPBMPT4-V012Z	91940
46468682	EPBBPN3-V034Z	96381
46474585	EPBMPT4-V032Z	96108
46531222	EPBMPN3-A002Z	96249
46533518	EPBMPT4-V003Z	93266
46553045	EPBMPT4-V003Z	93266
46769978	EPBBPT4-V010Z	91257
46769979	EPBMPN3-V022Z	91412
46811235	EPBMBN3-V001Z	92099
55206796	EPBMBN3-V001Z	92099
55206797	EPBBPT4-V001Z	92565
55209037	EPBMPT4-V003Z	93266
55209194	EPBBPN3-V007Z	97073
55219294	EPBMBN3-V001Z	92099
55219295	EPBBPN3-V007Z	97073
55219298	EPBBPT4-V001Z	92565
60809804	EPBMPN3-A043Z	92940
60811067	EPBMPN3-A002Z	96249
60811534	EPBMPN3-A003Z	92477
60814507	EPBMPN3-A002Z	96249
71714218	EPBMPT4-V012Z	91940
71718233	EPBMPT4-V012Z	91940
71718678	EPBMPT4-V012Z	91940
71728656	EPBMPT4-V012Z	91940
71732447	EPBMPT4-V003Z	93266
71739292	EPBMPN3-V005Z	93871
71741115	EPBMPN3-V010Z	93991
71742176	EPBMPN3-V031Z	92481

MASERATI	→ NTK	Stock
73503657	EPBBPT4-V001Z	92565
77363792	EPBMPN3-V022Z	91412
77364145	EPBMPT4-V003Z	93266
77364543	EPBBPT4-V010Z	91257
77364869	EPBMPT4-V003Z	93266
77365393	EPBBPT4-V001Z	92565
77366837	EPBMPT4-V028Z	93902
500309838	EPBMPN3-A002Z	96249
500351377	EPBBPT4-V005Z	93700
504064370	EPBBPT4-V010Z	91257
504088431	EPBBPT4-V001Z	92565
504245257	EPBBPT4-V001Z	92565
552182980	EPBBPT4-V001Z	92565
9609992380	EPBMPN3-A002Z	96249
9618261580	EPBMPN3-A009Z	92952
9619114980	EPBBPN3-A027Z	92471
9631716680	EPBBPN3-A003Z	91268
9631813680	EPBMPN3-A007Z	96754
9639381480	EPBMPT4-A001Z	93136
9639418880	EPBMPN3-A007Z	96754
9639418980	EPBMPN3-A020Z	96725
9639469280	EPBBPN3-A001Z	94263
9642789980	EPBBPN3-A006Z	91736
9649396580	EPBBPN3-A018Z	95753
9651931280	EPBBPN3-A017Z	95311
9660603480	EPBBPT4-A011Z	94601
9663480880	EPBMBT4-A003Z	93024
MAYBACH	→ NTK	Stock
41531828	EPBBPT4-V024Z	92064
41531828	EPBBPT4-V024Z	92064
41533128	EPBBPN3-A002Z	94523
41533128	EPBBPN3-A002Z	94523
41533328	EPBBPN3-A002Z	94523
41533328	EPBBPN3-A002Z	94523
41537028	EPBBPT4-V024Z	92064
41537028	EPBBPT4-V023Z	94656
41538428	EPBBPN3-A011Z	91149
41538428	EPBBPN3-A011Z	91149
51536128	EPBMPT4-V010Z	96347
51536128	EPBMPT4-V010Z	96347
51537228	EPBBPN3-A002Z	94523
51537228	EPBBPN3-A002Z	94523
61531428	EPBBPN3-A002Z	94523
61531428	EPBBPN3-A002Z	94523
61531528	EPBBPN3-A011Z	91149
61531528	EPBBPN3-A011Z	91149
61531628	EPBMBN3-A003Z	90717
61534728	EPBMPT4-V010Z	96347
61534728	EPBMPT4-V010Z	96347
61539828	EPBBPN3-A002Z	94523
61539828	EPBBPN3-A002Z	94523
61539928	EPBBPN3-A011Z	91149



MAYBACH	→ NTK	Stock
61539928	EPBBPN3-A011Z	91149
71530028	EPBMBN3-A003Z	90717
115420617	EPBMPN3-A038Z	94914
115420617	EPBMPN3-A038Z	94914
235454532	EPBMPN3-A003Z	92477
235454532	EPBMPN3-A003Z	92477
1571530028	EPBMPT4-V038Z	94727
0003121V002	EPBBPN3-A015Z	96911
0016146V001	EPBBPN3-A002Z	94523
A0041531828	EPBBPT4-V024Z	92064
A0041533028	EPBMPN3-A004Z	90833
A0041533128	EPBBPN3-A002Z	94523
A0041533228	EPBMPN3-A004Z	90833
A0041533328	EPBBPN3-A002Z	94523
A0041537028	EPBBPT4-V024Z	92064
A0041538428	EPBBPN3-A011Z	91149
A0051535028	EPBMPN3-A004Z	90833
A0051536128	EPBMPT4-V010Z	96347
A0051537228	EPBBPN3-A002Z	94523
A0061531328	EPBMPN3-A004Z	90833
A0061531428	EPBBPN3-A002Z	94523
A0061531528	EPBBPN3-A011Z	91149
A0061531628	EPBMBN3-A003Z	90717
A0061534728	EPBMPT4-V010Z	96347
A0061539728	EPBMPN3-A004Z	90833
A0061539828	EPBBPN3-A002Z	94523
A0061539928	EPBBPN3-A011Z	91149
A0071530028	EPBMBN3-A003Z	90717
A0235454532	EPBMPN3-A003Z	92477
A1571530028	EPBMPT4-V038Z	94727
A4518206910	EPBMPT4-V021Z	97498
A4518207010	EPBMPT4-V027Z	93059
MAZ	→ NTK	Stock
41531828	EPBBPT4-V024Z	92064
MAZDA	→ NTK	Stock
4S4G9F479AC	EPBMPN4-A035Z	96317
C20118211A	EPBMPT4-A007Z	96755
KL4718211A	EPBMPN3-A016Z	96896
L30118211	EPBMPN4-A035Z	96317
L30118211A	EPBMPN4-A035Z	96317
L30118211B	EPBMPN4-A035Z	96317
L80818211	EPBMPN4-A034Z	95507
L80818211Z01	EPBMPN4-A034Z	95507
LF0118211	EPBMPN4-A035Z	96317
LF0118211A	EPBMPN4-A035Z	96317
RF7J18211	EPBMPN3-V024Z	93159
U20218211	EPBMPN3-V019Z	93061
WE0118211	EPBBPT4-V001Z	92565
Y40418211	EPBBPN3-A006Z	91736
Y60118211A	EPBBPN3-A001Z	94263
Y60118211B	EPBBPN3-A001Z	94263
Y65018845	EPBMBT4-A003Z	93024

MAZDA	→ NTK	Stock
Y65518845	EPBMBT4-A003Z	93024
ZJ2018211	EPBMPN3-V032Z	94413
MCLAREN	→ NTK	Stock
11H0286CP01	EPBBPN3-V014Z	96895
11M0852CP01	EPBBPT4-V001Z	92565
14F0322CP01	EPBBPT4-V001Z	92565
MERCEDES-BENZ	→ NTK	Stock
41531828	EPBBPT4-V024Z	92064
41533128	EPBBPN3-A002Z	94523
41533328	EPBBPN3-A002Z	94523
41537028	EPBBPT4-V023Z	94656
41537028	EPBBPT4-V024Z	92064
41538428	EPBBPN3-A011Z	91149
51536128	EPBMPT4-V010Z	96347
51537228	EPBBPN3-A002Z	94523
61531428	EPBBPN3-A002Z	94523
61531528	EPBBPN3-A011Z	91149
61531628	EPBMBN3-A003Z	90717
61534728	EPBMPT4-V010Z	96347
61539828	EPBBPN3-A002Z	94523
61539928	EPBBPN3-A011Z	91149
71530028	EPBMBN3-A003Z	90717
81530228	EPBMBN3-V007Z	96602
101537228	EPBMBN3-A003Z	90717
115420617	EPBMPN3-A038Z	94914
235454532	EPBMPN3-A003Z	92477
1571530028	EPBMPT4-V038Z	94727
1571530128	EPBBPT4-V001Z	92565
0003121V002	EPBBPN3-A015Z	96911
0016146V001	EPBBPN3-A002Z	94523
A0041531828	EPBBPT4-V024Z	92064
A0041533028	EPBMPN3-A004Z	90833
A0041533128	EPBBPN3-A002Z	94523
A0041533228	EPBMPN3-A004Z	90833
A0041533328	EPBBPN3-A002Z	94523
A0041537028	EPBBPT4-V023Z	94656
A0041537028	EPBBPT4-V024Z	92064
A0041538428	EPBBPN3-A011Z	91149
A0051535028	EPBMPN3-A004Z	90833
A0051536128	EPBMPT4-V010Z	96347
A0051537228	EPBBPN3-A002Z	94523
A0061531328	EPBMPN3-A004Z	90833
A0061531428	EPBBPN3-A002Z	94523
A0061531528	EPBBPN3-A011Z	91149
A0061531628	EPBMBN3-A003Z	90717
A0061534728	EPBMPT4-V010Z	96347
A0061539728	EPBMPN3-A004Z	90833
A0061539828	EPBBPN3-A002Z	94523
A0061539928	EPBBPN3-A011Z	91149
A0071530028	EPBMBN3-A003Z	90717
A0081530228	EPBMBN3-V007Z	96602
A0101537228	EPBMBN3-A003Z	90717

MERCEDES-BENZ	→ NTK	Stock
A0115420717	EPBBPN3-A009Z	96930
A0235454532	EPBMPN3-A003Z	92477
A1571530028	EPBMPT4-V038Z	94727
A1571530128	EPBBPT4-V001Z	92565
A4518206910	EPBMPT4-V021Z	97498
A4518207010	EPBMPT4-V027Z	93059
A6079053500	EPBBPN3-V016Z	92713
MN195775	EPBMPT4-V010Z	96347
MR985032	EPBMPT4-V010Z	96347
Q0003121V003	EPBMBN3-V001Z	92099
MG	→ NTK	Stock
MHK100410	EPBBPN3-A022Z	92949
MHK100410L	EPBBPN3-A028Z	93277
MHK100590	EPBMPN3-R012Z	96590
MHK100820	EPBMPT4-V009Z	96309
MHK101040	EPBBPT4-V008Z	92801
MHK101060	EPBBPN3-A005Z	90934
MHK101060L	EPBBPN3-A005Z	90934
MHK101190	EPBBPN3-A028Z	93277
MHK101190A	EPBBPN3-A028Z	93277
MINI	→ NTK	Stock
872648	EPBMPT4-V009Z	96309
872679	EPBBPT4-V008Z	92801
2244674	EPBBPN3-A013Z	95023
2246977	EPBBPN3-A005Z	90934
7535069	EPBBPT4-A016Z	95268
7540508	EPBBPN3-A024Z	91449
7551429	EPBBPT4-V006Z	96941
7585493	EPBBPT4-V006Z	96941
7787142	EPBBPN3-A004Z	97711
7804742	EPBMBN3-V002Z	94886
12140872648	EPBMPT4-V009Z	96309
12140872679	EPBBPT4-V008Z	92801
13327785354	EPBBPN3-A020Z	91829
13617787142	EPBBPN3-A004Z	97711
13622244674	EPBBPN3-A013Z	95023
136222446977	EPBBPN3-A005Z	90934
13627535069	EPBBPT4-A016Z	95268
13627539811	EPBMPT4-A006Z	96115
13627540508	EPBBPN3-A024Z	91449
13627551429	EPBBPT4-V006Z	96941
13627582552	EPBMPN3-A044Z	93056
13627585493	EPBBPT4-V006Z	96941
13627599907	EPBBPN3-V030Z	94092
13627794981	EPBBPN3-A001Z	94263
13627801387	EPBMBN3-V004Z	90962
13627804742	EPBMBN3-V002Z	94886
13627966237	EPBBPT4-V010Z	91257
13628570118	EPBMBN3-V002Z	94886
13628637896	EPBMBN3-V002Z	94886
MITSUBISHI	→ NTK	Stock
1865A049	EPBMPT4-V021Z	97498

MITSUBISHI	→ NTK	Stock
1865A050	EPBMPT4-V027Z	93059
1865A122	EPBBPN3-A018Z	95753
E001T42171	EPBMPT4-V045Z	91802
E1T26571A	EPBMPN3-V031Z	92481
E1T42171	EPBMPT4-V045Z	91802
M889795	EPBMPN3-V013Z	94788
MB16244349	EPBBPN3-A002Z	94523
MD355556	EPBMPT4-V045Z	91802
MN191138	EPBBPT4-V002Z	95912
MN195775	EPBMPT4-V010Z	96347
MN960275	EPBBPN3-A011Z	91149
MN960418	EPBBPN3-A011Z	91149
MR985032	EPBMPT4-V010Z	96347
MWM	→ NTK	Stock
940700690024	EPBBPT4-V005Z	93700
940700690034	EPBBPN3-V014Z	96895
961200690024	EPBBPT4-V001Z	92565
961200690054	EPBBPT4-V001Z	92565
9 61200690054	EPBBPT4-V001Z	92565
NEW HOLLAND	→ NTK	Stock
504369148	EPBBPT4-V001Z	92565
NISSAN	→ NTK	Stock
8200685363	EPBBPN3-V016Z	92713
8200719629	EPBMPN3-V001Z	90037
0113100Q0B	EPBBPN3-V016Z	92713
223650001R	EPBBPN3-V007Z	97073
2236500QAA	EPBMBN3-V001Z	92099
2236500QAB	EPBBPN3-V008Z	90842
2236500QAJ	EPBMBN3-V001Z	92099
223651HC0A	EPBMPN3-A048Z	94778
223651KC0A	EPBMPT4-A046Z	92256
223654BD0A	EPBBPN3-V016Z	92713
223655X20A	EPBBPN3-V016Z	92713
223657266R	EPBBPN3-V014Z	96895
22365AX000	EPBMPT4-V016Z	92071
22365AX00A	EPBMPT4-V016Z	92071
22365BC400	EPBBPN3-V007Z	97073
22365BN701	EPBMBN3-V001Z	92099
22365EY00B	EPBMPN3-A050Z	96018
22365EY00C	EPBMPN3-A050Z	96018
22365EY01B	EPBMPN3-A049Z	93927
22365EY01C	EPBMPN3-A049Z	93927
22365JF00A	EPBMPN3-A047Z	90252
22365JF00C	EPBMPN3-A047Z	90252
22365JF00D	EPBMPN3-A047Z	90252
22365VC100	EPBMPN3-A052Z	93614
22365VC10A	EPBMPN3-A052Z	93614
2263000Q0E	EPBBPN3-V016Z	92713
2263000Q2F	EPBMPT4-V029Z	90509
2263000Q2G	EPBBPN3-V014Z	96895
2263000Q3H	EPBBPN3-V016Z	92713
22635AY902	EPBBPN3-V014Z	96895



NISSAN	→ NTK	Stock
2373100Q0H	EPBBPN3-V016Z	92713
2373100Q0L	EPBBPN3-V016Z	92713
2508500Q0A	EPBBPN3-V007Z	97073
2508500Q0B	EPBMPN3-V001Z	90037
2508500Q0C	EPBBPN3-V007Z	97073
2508500QAA	EPBMPN3-V001Z	90037
2508500QAB	EPBMPT4-V029Z	90509
2508500QAC	EPBBPN3-V014Z	96895
25085AW300	EPBBPN3-V007Z	97073

OPEL	→ NTK	Stock
815701	EPBMPN3-A003Z	92477
851365	EPBBPN3-A012Z	91308
1211230	EPBMPN3-A036Z	95612
1235029	EPBBPT4-V001Z	92565
1235040	EPBMPN3-V017Z	91253
1235046	EPBMPN3-V005Z	93871
1235060	EPBMPN3-V017Z	91253
1235083	EPBMBN3-V001Z	92099
1235084	EPBBPT4-V001Z	92565
1235258	EPBMBN3-V001Z	92099
1238244	EPBBPT4-V010Z	91257
1238269	EPBBPN3-V029Z	92983
1238394	EPBMPN3-V041Z	92257
1238395	EPBMPN3-V017Z	91253
1238572	EPBMPN3-A033Z	96422
1238786	EPBMPN3-A033Z	96422
1238788	EPBMPN3-A003Z	92477
1238894	EPBMPN3-V017Z	91253
1247047	EPBMPN3-V005Z	93871
1247049	EPBMPN3-V006Z	97501
1247128	EPBBPT4-V010Z	91257
1247461	EPBMBN3-V001Z	92099
1247474	EPBMPT4-V003Z	93266
1247478	EPBBPT4-V010Z	91257
1247809	EPBBPT4-V010Z	91257
3648776	EPBBPN3-V030Z	94092
4401593	EPBMBN3-V001Z	92099
4401787	EPBMPT4-V029Z	90509
4406441	EPBBPN3-V014Z	96895
4410279	EPBBPN3-V008Z	90842
4412919	EPBBPN3-V014Z	96895
4417030	EPBBPN3-V007Z	97073
4420747	EPBBPN3-V016Z	92713
4435200	EPBMPN3-V001Z	90037
4451799	EPBBPN3-V007Z	97073
4500031	EPBMPN3-A033Z	96422
4709264	EPBMBN3-V001Z	92099
4709502	EPBMPN3-V026Z	94423
4803140	EPBMBT4-V004Z	96629
4803550	EPBMPN3-V018Z	97066
4819481	EPBMPN3-V017Z	91253
5850801	EPBBPN3-A005Z	90934

OPEL	→ NTK	Stock
6235606	EPBBPN3-V010Z	95936
6235631	EPBMBN3-V001Z	92099
6235635	EPBMPT4-V026Z	91770
6235695	EPBMPN3-A033Z	96422
6235707	EPBMPN3-V010Z	93991
6235728	EPBMPN3-V010Z	93991
6238084	EPBMPN3-A028Z	93480
6238120	EPBMPN3-V005Z	93871
6238159	EPBMPN3-V005Z	93871
6238166	EPBMPN3-V006Z	97501
6238210	EPBBPT4-V001Z	92565
6238222	EPBBPN3-A020Z	91829
6238332	EPBBPN3-A013Z	95023
6238391	EPBBPN3-A015Z	96911
6238412	EPBBPN3-A015Z	96911
6238678	EPBMBT4-A002Z	92144
6238680	EPBMPT4-V026Z	91770
6238865	EPBBPT4-V001Z	92565
6238927	EPBMPN3-A003Z	92477
9109593	EPBMBN3-V001Z	92099
9117763	EPBMPN3-A028Z	93480
9158595	EPBBPT4-V001Z	92565
9196671	EPBBPT4-V001Z	92565
12569240	EPBMPN3-A003Z	92477
12575467	EPBMPN3-V010Z	93991
16017460	EPBMPN3-A003Z	92477
16137039	EPBMPN3-A003Z	92477
16212460	EPBMPN3-V005Z	93871
24420587	EPBMPN3-V010Z	93991
24420761	EPBBPN3-A012Z	91308
24459853	EPBBPT4-V001Z	92565
28074365	EPBMPN3-V005Z	93871
55206797	EPBBPT4-V001Z	92565
55219294	EPBMBN3-V001Z	92099
55219298	EPBBPT4-V001Z	92565
55238125	EPBBPT4-V010Z	91257
55563375	EPBMPN3-V041Z	92257
55567257	EPBBPN3-V029Z	92983
55568175	EPBBPT4-V001Z	92565
55573248	EPBMPN3-V017Z	91253
90499610	EPBBPN3-A015Z	96911
90541409	EPBBPN3-A015Z	96911
93168455	EPBBPN3-V016Z	92713
93170309	EPBBPT4-V010Z	91257
93171176	EPBBPT4-V001Z	92565
93177414	EPBMBN3-V001Z	92099
93190052	EPBMBN3-V001Z	92099
93192107	EPBMPN3-V017Z	91253
93194115	EPBMBN3-V001Z	92099
93194419	EPBMPN3-V026Z	94423
93198753	EPBBPN3-V007Z	97073
93198836	EPBMBN3-V001Z	92099

OPEL	→ NTK	Stock
93399801	EPBMPT4-V038Z	94727
93857938	EPBBPN3-V007Z	97073
94705196	EPBMPT4-V038Z	94727
95512870	EPBBPT4-V010Z	91257
97180655	EPBMPN3-V006Z	97501
97287868	EPBBPN3-V010Z	95936
98131026	EPBMPN3-V006Z	97501
PEUGEOT	→ NTK	Stock
163639	EPBBPT4-V001Z	92565
163661	EPBBPT4-V001Z	92565
457403	EPBMPN3-A020Z	96725
457405	EPBMPN3-A020Z	96725
467680	EPBMPT4-A001Z	93136
594607	EPBMPN3-A003Z	92477
594609	EPBMPN3-A003Z	92477
96092693	EPBMPN3-A002Z	96249
96107893	EPBMPN3-A027Z	90915
96195593	EPBBPN3-A028Z	93277
96365830	EPBMPT4-A001Z	93136
9631716680	EPBBPN3-A003Z	91268
9639027480	EPBBPN3-A001Z	94263
9639381480	EPBMPT4-A001Z	93136
9639418980	EPBMPN3-A020Z	96725
9639469280	EPBBPN3-A001Z	94263
9642789980	EPBBPN3-A006Z	91736
9651931280	EPBBPN3-A017Z	95311
9660603480	EPBBPT4-A011Z	94601
9663480880	EPBMBT4-A003Z	93024
9675379580	EPBMPN3-V019Z	93061
9805500380	EPBMBT4-A003Z	93024
1563J4	EPBMPN3-A002Z	96249
19200E	EPBMPN3-A009Z	92952
19201K	EPBMPN3-A007Z	96754
19203L	EPBBPN3-A022Z	92949
19204S	EPBMPN3-A003Z	92477
19207T	EPBBPN3-A003Z	91268
19209H	EPBMPN3-A009Z	92952
1920AC	EPBMPN3-A020Z	96725
1920AJ	EPBMPT4-A001Z	93136
1920AN	EPBMPN3-A007Z	96754
1920CZ	EPBBPN3-A001Z	94263
1920FC	EPBMPN3-A003Z	92477
1920GH	EPBBPN3-A006Z	91736
1920J7	EPBMPN3-A002Z	96249
1920K8	EPBMPN3-A027Z	90915
1920KN	EPBMPT4-A030Z	96501
1920KZ	EPBBPN3-A024Z	91449
1920LA	EPBBPT4-A011Z	94601
1920LG	EPBBPN3-A018Z	95753
1920LH	EPBBPN3-A017Z	95311
1920LW	EPBMPT4-A006Z	96115
1920P2	EPBMPN3-A035Z	92810

PEUGEOT	→ NTK	Stock
1920QR	EPBMBT4-A003Z	93024
1920SS	EPBBPT4-V001Z	92565
1920X0	EPBBPN3-A027Z	92471
1922R6	EPBBPT4-A016Z	95268
1922W0	EPBBPN3-V030Z	94092
967783578A	EPBBPN3-V030Z	94092
V759990780	EPBBPN3-V030Z	94092
PONTIAC	→ NTK	Stock
1235046	EPBMPN3-V005Z	93871
9109593	EPBMBN3-V001Z	92099
9109787	EPBMPT4-V029Z	90509
9117763	EPBMPN3-A028Z	93480
9160331	EPBMPN3-A033Z	96422
9197948	EPBBPT4-V021Z	97219
9389131	EPBMPN3-A003Z	92477
12568929	EPBMPT4-V003Z	93266
12569240	EPBMPN3-A003Z	92477
12569241	EPBMPN3-A033Z	96422
12575467	EPBMPN3-V010Z	93991
12591290	EPBMPN3-V017Z	91253
12592017	EPBMBT4-V004Z	96629
12614970	EPBMPN3-V005Z	93871
12644228	EPBMPN3-V017Z	91253
12788793	EPBMPT4-V026Z	91770
16040609	EPBMPN3-A033Z	96422
16137039	EPBMPN3-A003Z	92477
16153989	EPBBPN3-A026Z	96088
16172899	EPBBPN3-A025Z	97101
16212460	EPBMPN3-V005Z	93871
16235939	EPBMPN3-V006Z	97501
16255839	EPBMPN3-V013Z	94788
16258659	EPBMPN3-V005Z	93871
24420587	EPBMPN3-V010Z	93991
24420761	EPBBPN3-A012Z	91308
25184080	EPBMPN3-V011Z	94242
25184087	EPBMPN3-V042Z	92659
28074365	EPBMPN3-V005Z	93871
55206797	EPBBPT4-V001Z	92565
55219294	EPBMBN3-V001Z	92099
55219298	EPBBPT4-V001Z	92565
55563262	EPBBPT4-V021Z	97219
55563267	EPBMPT4-V026Z	91770
55563375	EPBMPN3-V041Z	92257
55567257	EPBBPN3-V029Z	92983
55568175	EPBBPT4-V001Z	92565
55573248	EPBMPN3-V017Z	91253
55576223	EPBBPT4-V010Z	91257
90063543	EPBMPN3-V005Z	93871
90467558	EPBBPN3-A013Z	95023
90541409	EPBBPN3-A015Z	96911
91167213	EPBBPN3-V008Z	90842
93168455	EPBBPN3-V016Z	92713

PONTIAC	→ NTK	Stock
93170309	EPBBPT4-V010Z	91257
93171176	EPBBPT4-V001Z	92565
93171579	EPBBPN3-A005Z	90934
93171659	EPBBPN3-A020Z	91829
93177414	EPMBN3-V001Z	92099
93190052	EPMBN3-V001Z	92099
93192107	EPBMPN3-V017Z	91253
93194115	EPMBN3-V001Z	92099
93194419	EPBMPN3-V026Z	94423
93198487	EPBMPN3-V001Z	90037
93198753	EPBBPN3-V007Z	97073
93232415	EPBMPT4-V043Z	97765
93342430	EPBBPT4-V005Z	93700
93399801	EPBMPT4-V038Z	94727
93857938	EPBBPN3-V007Z	97073
95512846	EPBMPT4-V003Z	93266
96276354	EPBMPN3-V011Z	94242
96325870	EPBMPN3-V021Z	92226
96330547	EPBMPN3-V011Z	94242
96333468	EPBMPN3-V042Z	92659
96482570	EPBMPN3-V018Z	97066
97180655	EPBMPN3-V006Z	97501
97287868	EPBBPN3-V010Z	95936
97381191	EPMBT4-A002Z	92144
PORSCHE	→ NTK	Stock
95560618000	EPBBPT4-V010Z	91257
95560618010	EPBBPT4-V002Z	95912
95835505107	EPBMPN4-V013Z	93089
95860618010	EPBMPT4-V008Z	96201
99660618000	EPBBPT4-V010Z	91257
99760618000	EPBBPT4-V001Z	92565
03G906051D	EPBBPT4-V003Z	91742
03G906051E	EPBBPT4-V002Z	95912
PROTON	→ NTK	Stock
PW810694	EPBMPT4-V003Z	93266
RENAULT	→ NTK	Stock
1320683	EPBBPN3-V014Z	96895
1320767	EPBBPN3-V007Z	97073
7700101762	EPBMPN3-V001Z	90037
7700106644	EPBMPN3-V005Z	93871
7700106886	EPBMPN3-V013Z	94788
7700111957	EPBBPN3-V008Z	90842
7700267701	EPBMPN3-A033Z	96422
7700706876	EPBMPN3-A003Z	92477
7701062395	EPBBPN3-V016Z	92713
8200105165	EPBMPN3-V001Z	90037
8200121800	EPBMPN3-V001Z	90037
8200146271	EPBMPT4-V029Z	90509
8200155613	EPMBN3-V001Z	92099
8200168253	EPBBPN3-V007Z	97073
8200194432	EPBMPT4-V029Z	90509
8200225971	EPBBPN3-V014Z	96895

RENAULT	→ NTK	Stock
8200233831	EPBBPN3-V019Z	95201
8200292433	EPBBPN3-V016Z	92713
8200375080	EPBBPN4-V004Z	93057
8200375977	EPBBPN4-V004Z	93057
8200685363	EPBBPN3-V016Z	92713
8200715610	EPBBPN3-V014Z	96895
8200719629	EPBMPN3-V001Z	90037
8200750883	EPBMPT4-V029Z	90509
8200843680	EPBBPN3-V007Z	97073
8933000153	EPBMPN3-A003Z	92477
9618261580	EPBMPN3-A009Z	92952
9631813680	EPBMPN3-A007Z	96754
9635493480	EPBMPN3-A020Z	96725
9639418880	EPBMPN3-A007Z	96754
9639418980	EPBMPN3-A020Z	96725
223650001R	EPBBPN3-V007Z	97073
223650002R	EPBBPT4-V001Z	92565
223650754R	EPBBPN4-V004Z	93057
223653394R	EPBBPN3-V016Z	92713
223653795R	EPMBN3-V001Z	92099
223657266R	EPBBPN3-V014Z	96895
223658143R	EPBMPT4-V029Z	90509
223658570R	EPBBPN3-V019Z	95201
22365JF00A	EPBMPN3-A047Z	90252
22365JF00C	EPBMPN3-A047Z	90252
22365JF00D	EPBMPN3-A047Z	90252
E1199B	EPBBPN3-V014Z	96895
E1300A	EPBBPN3-V007Z	97073
H8200197927	EPBMPT4-V029Z	90509
H8200843680	EPBBPN3-V007Z	97073
ROLLS-ROYCE	→ NTK	Stock
038906051B	EPBBPT4-V003Z	91742
PF100636PB	EPBBPT4-V003Z	91742
UE75265	EPBMPN3-A027Z	90915
ROVER	→ NTK	Stock
6G9N12B676AB	EPBBPT4-V009Z	95675
LR021587	EPBBPT4-V009Z	95675
MHK100410	EPBBPN3-A022Z	92949
MHK100410L	EPBBPN3-A028Z	93277
MHK100590	EPBMPN3-R012Z	96590
MHK100640	EPBBPT4-V012Z	96542
MHK100820	EPBMPT4-V009Z	96309
MHK101040	EPBBPT4-V008Z	92801
MHK101060	EPBBPN3-A005Z	90934
MHK101060L	EPBBPN3-A005Z	90934
MHK101190	EPBBPN3-A028Z	93277
MHK101190A	EPBBPN3-A028Z	93277
SAAB	→ NTK	Stock
5166434	EPBMPT4-V003Z	93266
5167895	EPBMPN3-A034Z	92094
7538697	EPBBPN3-A033Z	96394
9132374	EPBBPN3-A025Z	97101

SAAB	→ NTK	Stock
9197948	EPBBPT4-V021Z	97219
9543901	EPBBPT4-V001Z	92565
12575467	EPBMPN3-V010Z	93991
12594942	EPBMPN3-V017Z	91253
12644228	EPBMPN3-V017Z	91253
12788793	EPBMPT4-V026Z	91770
16212460	EPBMPN3-V005Z	93871
24459853	EPBBPT4-V001Z	92565
55206797	EPBBPT4-V001Z	92565
55560162	EPBBPT4-V021Z	97219
55563262	EPBBPT4-V021Z	97219
55563267	EPBMPT4-V026Z	91770
55568175	EPBBPT4-V001Z	92565
93170309	EPBBPT4-V010Z	91257
93171176	EPBBPT4-V001Z	92565
93857938	EPBBPN3-V007Z	97073
SCANIA	→ NTK	Stock
4773800	EPBBPN3-A015Z	96911
5166434	EPBMPT4-V003Z	93266
5167895	EPBMPN3-A034Z	92094
SEAT	→ NTK	Stock
36906051	EPBMPT4-V004Z	92899
38906051	EPBMBT4-D001Z	91628
47906051	EPBMPT4-V022Z	90125
47906051	EPBMPT4-V022Z	90125
59906051	EPBBPT4-V019Z	95582
59906051	EPBBPT4-V019Z	95582
62906051	EPBMBT4-D001Z	91628
279980411	EPBMPT4-V004Z	92899
279980411	EPBMPT4-V008Z	96201
369980411	EPBMPT4-V004Z	92899
030906051A	EPBMPT4-D025Z	92358
036906051C	EPBMPN4-D019Z	91102
036906051D	EPBMPT4-V004Z	92899
036906051E	EPBMPN4-V040Z	95972
036906051F	EPBMPN4-V041Z	94063
036906051G	EPBMPN4-V013Z	93089
038906051A	EPBBPT4-V015Z	94877
038906051B	EPBBPT4-V003Z	91742
038906051C	EPBBPT4-V002Z	95912
038906051D	EPBBPN4-V014Z	93428
03C906051	EPBMPT4-V008Z	96201
03C906051E	EPBMPT4-V008Z	96201
03C906051F	EPBMPT4-V008Z	96201
03D906051	EPBMPT4-V011Z	91119
03D906051A	EPBMPT4-V011Z	91119
03G906051D	EPBBPT4-V003Z	91742
03G906051E	EPBBPT4-V002Z	95912
03G906051F	EPBBPT4-V002Z	95912
046130385A	EPBBPN3-A013Z	95023
04E906051	EPBBPT4-V002Z	95912
06B906051	EPBMPT4-D005Z	93653

SEAT	→ NTK	Stock
07C906051	EPBMPT4-D042Z	91710
1K0612041BT	EPBMPN4-V013Z	93089
1K0612041DH	EPBMPN4-V013Z	93089
1K0612041FE	EPBMPN4-V013Z	93089
1K0612041FR	EPBMPN4-V013Z	93089
1K0612041GH	EPBMPN4-V013Z	93089
1K0612041KA	EPBMPN4-V013Z	93089
2E0906051A	EPBMPN3-A004Z	90833
2P0906051	EPBBPT4-V005Z	93700
377906309C	EPBMPN3-A002Z	96249
3A0906051	EPBMPN3-A027Z	90915
5N0612041AH	EPBMPN4-V013Z	93089
5N0612041BA	EPBMPN4-V013Z	93089
6R1612041H	EPBMPN4-V013Z	93089
6R1612041M	EPBMPN4-V013Z	93089
6R1612041P	EPBMPN4-V013Z	93089
6R2612041AE	EPBMPN4-V013Z	93089
6R2612041J	EPBMPN4-V013Z	93089
6R2612051AE	EPBMPN4-V013Z	93089
7N0612041C	EPBMPN4-V013Z	93089
SETRA	→ NTK	Stock
41531828	EPBBPT4-V024Z	92064
SKODA	→ NTK	Stock
36906051	EPBMPT4-V004Z	92899
38906051	EPBMBT4-D001Z	91628
47906051	EPBMPT4-V022Z	90125
59906051	EPBBPT4-V019Z	95582
59906051	EPBBPT4-V019Z	95582
62906051	EPBMBT4-D001Z	91628
279980411	EPBMPT4-V008Z	96201
369980411	EPBMPT4-V004Z	92899
030906051A	EPBMPT4-D025Z	92358
036906051C	EPBMPN4-D019Z	91102
036906051D	EPBMPT4-V004Z	92899
036906051E	EPBMPN4-V040Z	95972
036906051F	EPBMPN4-V041Z	94063
036906051G	EPBMPN4-V013Z	93089
038906051A	EPBBPT4-V015Z	94877
038906051B	EPBBPT4-V003Z	91742
038906051C	EPBBPT4-V002Z	95912
038906051D	EPBBPN4-V014Z	93428
03C906051	EPBMPT4-V008Z	96201
03C906051E	EPBMPT4-V008Z	96201
03C906051F	EPBMPT4-V008Z	96201
03D906051	EPBMPT4-V011Z	91119
03D906051A	EPBMPT4-V011Z	91119
03G906051D	EPBBPT4-V003Z	91742
03G906051E	EPBBPT4-V002Z	95912
03G906051F	EPBBPT4-V002Z	95912
046130385A	EPBBPN3-A013Z	95023
04E906051	EPBBPT4-V002Z	95912
06B906051	EPBMPT4-D005Z	93653

SKODA	→ NTK	Stock
06G906051	EPBMPT4-V008Z	96201
07C906051	EPBMPT4-D042Z	91710
1K0612041BT	EPBMPN4-V013Z	93089
1K0612041DH	EPBMPN4-V013Z	93089
1K0612041FE	EPBMPN4-V013Z	93089
1K0612041FR	EPBMPN4-V013Z	93089
1K0612041GH	EPBMPN4-V013Z	93089
1K0612041HJ	EPBMPN4-V013Z	93089
2E0906051A	EPBMPN3-A004Z	90833
2P0906051	EPBBPT4-V005Z	93700
377906309C	EPBMPN3-A002Z	96249
3A0906051	EPBMPN3-A027Z	90915
5N0612041AH	EPBMPN4-V013Z	93089
6R1612041AL	EPBMPN4-V013Z	93089
6R1612041H	EPBMPN4-V013Z	93089
6R1612041M	EPBMPN4-V013Z	93089
6R1612041P	EPBMPN4-V013Z	93089
6R2612041AE	EPBMPN4-V013Z	93089
6R2612041J	EPBMPN4-V013Z	93089
6R2612051AE	EPBMPN4-V013Z	93089
7N0612041C	EPBMPN4-V013Z	93089
SMART	→ NTK	Stock
41531828	EPBBPT4-V024Z	92064
41531828	EPBBPT4-V024Z	92064
41533128	EPBBPN3-A002Z	94523
41533128	EPBBPN3-A002Z	94523
41533328	EPBBPN3-A002Z	94523
41533328	EPBBPN3-A002Z	94523
41537028	EPBBPT4-V024Z	92064
41537028	EPBBPT4-V023Z	94656
41538428	EPBBPN3-A011Z	91149
51536128	EPBMPT4-V010Z	96347
51537228	EPBBPN3-A002Z	94523
61531428	EPBBPN3-A002Z	94523
61531528	EPBBPN3-A011Z	91149
61531628	EPBMBN3-A003Z	90717
61534728	EPBMPT4-V010Z	96347
61539828	EPBBPN3-A002Z	94523
61539928	EPBBPN3-A011Z	91149
71530028	EPBMBN3-A003Z	90717
115420617	EPBMPN3-A038Z	94914
115420617	EPBMPN3-A038Z	94914
235454532	EPBMPN3-A003Z	92477
235454532	EPBMPN3-A003Z	92477
1571530028	EPBMPT4-V038Z	94727
0003121V002	EPBMBN3-V001Z	92099
0003121V002	EPBBPN3-A015Z	96911
0003121V002000000	EPBMBN3-V001Z	92099
0003121V003	EPBMBN3-V001Z	92099
0003121V003000000	EPBMBN3-V001Z	92099
0016146V001	EPBBPN3-A002Z	94523
A0041531828	EPBBPT4-V024Z	92064

SMART	→ NTK	Stock
A0041533028	EPBMPN3-A004Z	90833
A0041533128	EPBBPN3-A002Z	94523
A0041533228	EPBMPN3-A004Z	90833
A0041533328	EPBBPN3-A002Z	94523
A0041537028	EPBBPT4-V024Z	92064
A0041538428	EPBBPN3-A011Z	91149
A0051535028	EPBMPN3-A004Z	90833
A0051536128	EPBMPT4-V003Z	93266
A0051536128	EPBMPT4-V010Z	96347
A0051537228	EPBBPN3-A002Z	94523
A0061531328	EPBMPN3-A004Z	90833
A0061531428	EPBBPN3-A002Z	94523
A0061531528	EPBBPN3-A011Z	91149
A0061531628	EPBMBN3-A003Z	90717
A0061534728	EPBMPT4-V003Z	93266
A0061534728	EPBMPT4-V010Z	96347
A0061539728	EPBMPN3-A004Z	90833
A0061539828	EPBBPN3-A002Z	94523
A0061539928	EPBBPN3-A011Z	91149
A0071530028	EPBMBN3-A003Z	90717
A0235454532	EPBMPN3-A003Z	92477
A1571530028	EPBMPT4-V038Z	94727
A4518206910	EPBMPT4-V021Z	97498
A4518207010	EPBMPT4-V027Z	93059
Q0003121V002000000	EPBMBN3-V001Z	92099
Q0003121V003000000	EPBMBN3-V001Z	92099
Q0016146V001	EPBBPN3-A002Z	94523
SSANGYONG	→ NTK	Stock
1730940048	EPBMPT4-V016Z	92071
STEYR	→ NTK	Stock
41531828	EPBBPT4-V024Z	92064
41531828	EPBBPT4-V024Z	92064
41533128	EPBBPN3-A002Z	94523
41533128	EPBBPN3-A002Z	94523
41533328	EPBBPN3-A002Z	94523
41533328	EPBBPN3-A002Z	94523
41537028	EPBBPT4-V024Z	92064
41537028	EPBBPT4-V023Z	94656
41538428	EPBBPN3-A011Z	91149
41538428	EPBBPN3-A011Z	91149
51536128	EPBMPT4-V010Z	96347
51536128	EPBMPT4-V010Z	96347
51537228	EPBBPN3-A002Z	94523
51537228	EPBBPN3-A002Z	94523
61531428	EPBBPN3-A002Z	94523
61531428	EPBBPN3-A002Z	94523
61531528	EPBBPN3-A011Z	91149
61531528	EPBBPN3-A011Z	91149
61531628	EPBMBN3-A003Z	90717
61534728	EPBMPT4-V010Z	96347
61534728	EPBMPT4-V010Z	96347
61539828	EPBBPN3-A002Z	94523

STEYR	→ NTK	Stock
61539828	EPBBPN3-A002Z	94523
61539928	EPBBPN3-A011Z	91149
61539928	EPBBPN3-A011Z	91149
71530028	EPBMBN3-A003Z	90717
115420617	EPBMPN3-A038Z	94914
115420617	EPBMPN3-A038Z	94914
235454532	EPBMPN3-A003Z	92477
235454532	EPBMPN3-A003Z	92477
1571530028	EPBMPT4-V038Z	94727
0003121V002	EPBBPN3-A015Z	96911
0016146V001	EPBBPN3-A002Z	94523
A0041531828	EPBBPT4-V024Z	92064
A0041533028	EPBMPN3-A004Z	90833
A0041533128	EPBBPN3-A002Z	94523
A0041533228	EPBMPN3-A004Z	90833
A0041533328	EPBBPN3-A002Z	94523
A0041537028	EPBBPT4-V024Z	92064
A0041538428	EPBBPN3-A011Z	91149
A0051535028	EPBMPN3-A004Z	90833
A0051536128	EPBMPT4-V010Z	96347
A0051537228	EPBBPN3-A002Z	94523
A0061531328	EPBMPN3-A004Z	90833
A0061531428	EPBBPN3-A002Z	94523
A0061531528	EPBBPN3-A011Z	91149
A0061531628	EPBMBN3-A003Z	90717
A0061534728	EPBMPT4-V010Z	96347
A0061539728	EPBMPN3-A004Z	90833
A0061539828	EPBBPN3-A002Z	94523
A0061539928	EPBBPN3-A011Z	91149
A0071530028	EPBMBN3-A003Z	90717
A0235454532	EPBMPN3-A003Z	92477
A1571530028	EPBMPT4-V038Z	94727
A4518206910	EPBMPT4-V021Z	97498
A4518207010	EPBMPT4-V027Z	93059
SUBARU	→ NTK	Stock
8942120200	EPBMBN3-V005Z	90946
8942126030	EPBMPN3-V025Z	94855
8942152010	EPBMPT4-A030Z	96501
1859084E50	EPBMBN3-V001Z	92099
22012AA150	EPBMPN3-V025Z	94855
22012AA200	EPBMPN3-V025Z	94855
22012AA230	EPBMPN3-V025Z	94855
22627AA430	EPBMPT4-A024Z	91744
22634AA00A	EPBMPT4-V043Z	97765
SUZUKI	→ NTK	Stock
1859084E50	EPBMBN3-V001Z	92099
1859084E51	EPBMBN3-V001Z	92099
13660D70CA0C000	EPBMPT4-V038Z	94727
1859067G00	EPBBPN3-A003Z	91268
1859067G00000	EPBBPN3-A003Z	91268
1859067JA0	EPBBPN4-V004Z	93057
1859067JA0000	EPBBPN4-V004Z	93057

SUZUKI	→ NTK	Stock
1859068L00	EPBBPT4-V001Z	92565
1859068L00000	EPBBPT4-V001Z	92565
1859068L01	EPBBPT4-V001Z	92565
1859068L01000	EPBBPT4-V001Z	92565
1859069K00000	EPBBPN3-A001Z	94263
1859072F20000	EPBMPN3-V031Z	92481
1859072F21	EPBMPN3-V031Z	92481
1859072F21000	EPBMPN3-V031Z	92481
1859073J00000	EPBBPN3-A001Z	94263
1859073KA0	EPBMPN3-V026Z	94423
1859073KA0000	EPBMPN3-V026Z	94423
1859079G61	EPBBPT4-V001Z	92565
1859079G61000	EPBBPT4-V001Z	92565
1859080KA0	EPBBPN3-V016Z	92713
1859080KA0000	EPBBPN3-V016Z	92713
1859080KA1	EPBBPN3-V016Z	92713
1859080KA1000	EPBBPN3-V016Z	92713
1859080KC0	EPBBPN3-V016Z	92713
1859080KC0000	EPBBPN3-V016Z	92713
1859081A00	EPBMPN3-V025Z	94855
1859081A00000	EPBMPN3-V025Z	94855
1859084A00000	EPBBPN3-V014Z	96895
1859084A01	EPBBPN3-V014Z	96895
1859084A50	EPBBPN3-V007Z	97073
1859084A50000	EPBBPN3-V007Z	97073
1859084A51000	EPBBPN3-V007Z	97073
1859084E50000	EPBMBN3-V001Z	92099
1859084E51000	EPBMBN3-V001Z	92099
1859086j00	EPBMBN3-V001Z	92099
1859086J00000	EPBMBN3-V001Z	92099
1859086J01	EPBMBN3-V001Z	92099
1859086J01000	EPBMBN3-V001Z	92099
18590M86J00	EPBMBN3-V001Z	92099
18590M86J00000	EPBMBN3-V001Z	92099
18590M86J01	EPBMBN3-V001Z	92099
18590M86J01000	EPBMBN3-V001Z	92099
18590N86J00	EPBMBN3-V001Z	92099
18590N86J00000	EPBMBN3-V001Z	92099
TOYOTA	→ NTK	Stock
8942012210	EPBMBN3-V004Z	90962
8942012220	EPBMBN3-V004Z	90962
8942012230	EPBMPN3-V025Z	94855
8942012240	EPBMPN3-V025Z	94855
8942012250	EPBMPN3-V025Z	94855
8942012270	EPBMPN3-V025Z	94855
8942060040	EPBMPN3-V025Z	94855
8942074010	EPBMPN3-V025Z	94855
8942120190	EPBMPN3-V025Z	94855
8942120200	EPBMBN3-V005Z	90946
8942126030	EPBMPN3-V025Z	94855
8942137010	EPBMPN3-V025Z	94855
8942137030	EPBMPN3-V025Z	94855



TOYOTA	→ NTK	Stock
8942147010	EPBMPN4-A023Z	91984
8942152010	EPBMPT4-A030Z	96501
8942171020	EPBMBN3-V004Z	90962
8942171030	EPBMBN3-V005Z	90946
89420WA010	EPBMBN3-V002Z	94886
89421WAA01	EPBMBN3-V002Z	94886
SU00100645	EPBBPN3-A006Z	91736
VAG	→ NTK	Stock
036906051E	EPBMPN4-V040Z	95972
07C906051	EPBMPT4-D042Z	91710
VAUXHALL	→ NTK	Stock
9109593	EPBMBN3-V001Z	92099
9117763	EPBMPN3-A028Z	93480
12575467	EPBMPN3-V010Z	93991
12591290	EPBMPN3-V017Z	91253
16212460	EPBMPN3-V005Z	93871
24420587	EPBMPN3-V010Z	93991
24420761	EPBBPN3-A012Z	91308
28074365	EPBMPN3-V005Z	93871
55206797	EPBBPT4-V001Z	92565
55219294	EPBMBN3-V001Z	92099
55219298	EPBBPT4-V001Z	92565
55563375	EPBMPN3-V041Z	92257
55567257	EPBBPN3-V029Z	92983
55568175	EPBBPT4-V001Z	92565
55573248	EPBMPN3-V017Z	91253
90499610	EPBBPN3-A015Z	96911
90541409	EPBBPN3-A015Z	96911
93168455	EPBBPN3-V016Z	92713
93170309	EPBBPT4-V010Z	91257
93171176	EPBBPT4-V001Z	92565
93177414	EPBMBN3-V001Z	92099
93190052	EPBMBN3-V001Z	92099
93192107	EPBMPN3-V017Z	91253
93194115	EPBMBN3-V001Z	92099
93194419	EPBMPN3-V026Z	94423
93198753	EPBBPN3-V007Z	97073
93198836	EPBMBN3-V001Z	92099
93857938	EPBBPN3-V007Z	97073
97180655	EPBMPN3-V006Z	97501
97287868	EPBBPN3-V010Z	95936
98131026	EPBMPN3-V006Z	97501
VM	→ NTK	Stock
45962048F	EPBBPT4-V012Z	96542
45962067F	EPBBPT4-V005Z	93700
45962069F	EPBBPT4-V001Z	92565
45962082F	EPBBPT4-V001Z	92565
VOLVO	→ NTK	Stock
1275170	EPBBPN3-A013Z	95023
1275342	EPBMPN3-A040Z	94558
1336384	EPBMPN3-A033Z	96422
1378162	EPBMPN3-A003Z	92477

VOLVO	→ NTK	Stock
3411400	EPBMPN3-A003Z	92477
3507100	EPBMPN3-A003Z	92477
8627466	EPBMPN3-A045Z	93151
8658493	EPBMPN3-A039Z	97513
8658536	EPBBPT4-V018Z	91887
8670292	EPBBPN3-A001Z	94263
8677288	EPBBPT4-V013Z	91803
8699448	EPBBPT4-V018Z	91887
9125462	EPBBPN3-V034Z	96381
9202701	EPBMPN3-A037Z	94170
9470007	EPBMPN3-A023Z	96241
9486209	EPBMPN3-A014Z	90281
30622083	EPBBPT4-V009Z	95675
30650014	EPBBPT4-V018Z	91887
30658184	EPBMPT4-A017Z	96798
30711659	EPBMPT4-A007Z	96755
30725679	EPBMBT4-A003Z	93024
30725865	EPBMBT4-A003Z	93024
30756098	EPBBPT4-V018Z	91887
30850992	EPBMPN3-A040Z	94558
30889795	EPBMPN3-V013Z	94788
31216185	EPBBPN3-A001Z	94263
31216308	EPBBPN4-A020Z	92413
31251242	EPBMPT4-A017Z	96798
31272731	EPBBPT4-V018Z	91887
31303211	EPBMPN3-A003Z	92477
31303975	EPBBPT4-V009Z	95675
31316349	EPBMPN3-V019Z	93061
31319622	EPBMBT4-A003Z	93024
31338107	EPBMPN3-V019Z	93061
31339551	EPBMPT4-A007Z	96755
31355463	EPBBPT4-V009Z	95675
31355464	EPBBPT4-V013Z	91803
31355973	EPBMPT4-V028Z	93902
31405340	EPBMPT4-V028Z	93902
31432308	EPBMPT4-V028Z	93902
32208434	EPBMPT4-V028Z	93902
86584930	EPBMPN3-A039Z	97513
86994480	EPBBPT4-V018Z	91887
SMN195775	EPBMPT4-V010Z	96347
SMR985032	EPBMPT4-V010Z	96347
VW	→ NTK	Stock
30906051	EPBMPT4-D025Z	92358
36906051	EPBMPT4-V004Z	92899
38906051	EPBMBT4-D001Z	91628
47906051	EPBMPT4-V022Z	90125
47906051	EPBMPT4-V022Z	90125
59906051	EPBBPT4-V019Z	95582
62906051	EPBMBT4-D001Z	91628
279980411	EPBMPT4-V008Z	96201
369980411	EPBMPT4-V004Z	92899
030905051A	EPBMPT4-D025Z	92358

VW	→ NTK	Stock
030906051A	EPBMPT4-D025Z	92358
036906051C	EPBMPN4-D019Z	91102
036906051D	EPBMPT4-V004Z	92899
036906051E	EPBMPN4-V040Z	95972
036906051F	EPBMPN4-V041Z	94063
036906051G	EPBMPN4-V013Z	93089
038906051A	EPBBPT4-V015Z	94877
038906051B	EPBBPT4-V003Z	91742
038906051C	EPBBPT4-V002Z	95912
038906051D	EPBBPN4-V014Z	93428
03C906051	EPBMPT4-V008Z	96201
03C906051E	EPBMPT4-V008Z	96201
03C906051F	EPBMPT4-V008Z	96201
03D906051	EPBMPT4-V011Z	91119
03D906051A	EPBMPT4-V011Z	91119
03F145673F	EPBBPT4-V003Z	91742
03G906051D	EPBBPT4-V003Z	91742
03G906051E	EPBBPT4-V002Z	95912
03G906051F	EPBBPT4-V002Z	95912
046130385A	EPBBPN3-A013Z	95023
04E906051	EPBBPT4-V002Z	95912
06B906051	EPBMPT4-D005Z	93653
07C906051	EPBMPT4-D042Z	91710
1K0612041BT	EPBMPN4-V013Z	93089
1K0612041DH	EPBMPN4-V013Z	93089
1K0612041FE	EPBMPN4-V013Z	93089
1K0612041FR	EPBMPN4-V013Z	93089
1K0612041GH	EPBMPN4-V013Z	93089
1K0612041HB	EPBMPN4-V013Z	93089
1K0612041HJ	EPBMPN4-V013Z	93089
1K0612041HL	EPBMPN4-V013Z	93089
1K0612041JL	EPBMPN4-V013Z	93089
1K0612041KA	EPBMPN4-V013Z	93089
1K0612041KE	EPBMPN4-V013Z	93089
1K0612041KP	EPBMPN4-V013Z	93089
1K0612041LG	EPBMPN4-V013Z	93089
2E0906051A	EPBMPN3-A004Z	90833
2P0906051	EPBBPT4-V005Z	93700
2R0906051C	EPBBPT4-V001Z	92565
377906309C	EPBMPN3-A002Z	96249
3A0906051	EPBMPN3-A027Z	90915
3AA612041AC	EPBMPN4-V013Z	93089
3AA612041AG	EPBMPN4-V013Z	93089
5N0612041AF	EPBMPN4-V013Z	93089
5N0612041AH	EPBMPN4-V013Z	93089
5N0612041BA	EPBMPN4-V013Z	93089
6R1612041H	EPBMPN4-V013Z	93089
6R1612041P	EPBMPN4-V013Z	93089
6R2612041AE	EPBMPN4-V013Z	93089
6R2612041J	EPBMPN4-V013Z	93089
6R2612051AE	EPBMPN4-V013Z	93089
7N0612041C	EPBMPN4-V013Z	93089

VW	→ NTK	Stock
7N0612041D	EPBMPN4-V013Z	93089
WULING	→ NTK	Stock
9003817	EPBMPT4-V038Z	94727

BERU by DRiV	→ NTK	Stock
1410281	EPBMPT4-V004Z	92899
1411891	EPBMPN3-A003Z	92477
1416742	EPBBPT4-V003Z	91742
1418573	EPBMPT4-A001Z	93136
1421692	EPBMPN3-V005Z	93871
8005833	EPBMPT4-D005Z	93653
8025656	EPBMPN3-A007Z	96754
SPR200	EPBMPN3-A003Z	92477
SPR202	EPBMPT4-D005Z	93653
SPR203	EPBMPT4-V004Z	92899
SPR204	EPBBPT4-V003Z	91742
SPR205	EPBMPT4-A001Z	93136
SPR208	EPBMPN3-V005Z	93871
SPR211	EPBMPN3-A007Z	96754

Bosch	→ NTK	Stock
0 261 230 004	EPBMPN3-A027Z	90915
0 261 230 009	EPBMPN3-A028Z	93480
0 261 230 011	EPBMPT4-D025Z	92358
0 261 230 012	EPBMPN3-A009Z	92952
0 261 230 013	EPBMPT4-V043Z	97765
0 261 230 020	EPBMPN3-A034Z	92094
0 261 230 027	EPBMPT4-A036Z	97175
0 261 230 029	EPBBPN3-V034Z	96381
0 261 230 030	EPBMPT4-V003Z	93266
0 261 230 031	EPBMPT4-D005Z	93653
0 261 230 035	EPBMPT4-V032Z	96108
0 261 230 037	EPBMPN3-A027Z	90915
0 261 230 041	EPBMPN3-A020Z	96725
0 261 230 042	EPBBPT4-V010Z	91257
0 261 230 043	EPBMPT4-A001Z	93136
0 261 230 044	EPBMPT4-A017Z	96798
0 261 230 049	EPBBPN3-A015Z	96911
0 261 230 052	EPBMPN3-V022Z	91412
0 261 230 057	EPBMPN3-A007Z	96754
0 261 230 058	EPBMPN3-A020Z	96725
0 261 230 073	EPBBPN4-V014Z	93428
0 261 230 075	EPBMPT4-V003Z	93266
0 261 230 081	EPBMPN4-V013Z	93089
0 261 230 090	EPBBPT4-V013Z	91803
0 261 230 095	EPBMPT4-V008Z	96201
0 261 230 099	EPBMPT4-V038Z	94727
0 261 230 101	EPBMPN3-V010Z	93991
0 261 230 105	EPBBPT4-V009Z	95675
0 261 230 118	EPBMPT4-V010Z	96347
0 261 230 119	EPBBPN3-V021Z	95679
0 261 230 131	EPBBPT4-A011Z	94601
0 261 230 134	EPBBPT4-A016Z	95268
0 261 230 135	EPBBPN3-A024Z	91449
0 261 230 136	EPBMPT4-A006Z	96115
0 261 230 141	EPBBPN3-A002Z	94523
0 261 230 155	EPBMPN3-V017Z	91253
0 261 230 167	EPBMPT4-D042Z	91710

Bosch	→ NTK	Stock
0 261 230 180	EPBMPN4-A035Z	96317
0 261 230 189	EPBMPN3-A004Z	90833
0 261 230 191	EPBBPN3-A002Z	94523
0 261 230 193	EPBBPN3-A011Z	91149
0 261 230 197	EPBMPN3-V026Z	94423
0 261 230 217	EPBMPT4-V038Z	94727
0 261 230 224	EPBBPT4-A011Z	94601
0 261 230 232	EPBMPN3-A044Z	93056
0 261 230 234	EPBMPT4-V008Z	96201
0 261 230 245	EPBMPT4-V003Z	93266
0 261 230 253	EPBBPN3-V030Z	94092
0 261 230 262	EPBBPN3-V029Z	92983
0 261 230 264	EPBMPN3-V019Z	93061
0 261 230 266	EPBBPT4-V003Z	91742
0 261 230 266	EPBBPN4-V014Z	93428
0 261 230 268	EPBMPT4-V003Z	93266
0 261 230 280	EPBBPT4-V001Z	92565
0 261 230 282	EPBMPN3-V017Z	91253
0 261 230 283	EPBBPT4-V010Z	91257
0 261 230 284	EPBMBN3-V001Z	92099
0 261 230 289	EPBMPN3-V017Z	91253
0 261 230 295	EPBBPT4-V009Z	95675
0 261 230 308	EPBMPN3-V019Z	93061
0 261 230 313	EPBBPT4-V001Z	92565
0 261 230 344	EPBMPT4-A001Z	93136
0 261 230 439	EPBMBN3-A003Z	90717
0 281 002 122	EPBBPN3-A022Z	92949
0 281 002 122	EPBBPN3-A028Z	93277
0 281 002 122	EPBBPN3-A015Z	96911
0 281 002 137	EPBBPN3-A015Z	96911
0 281 002 177	EPBMBT4-D001Z	91628
0 281 002 205	EPBBPT4-V012Z	96542
0 281 002 215	EPBBPN3-V034Z	96381
0 281 002 244	EPBBPT4-V024Z	92064
0 281 002 326	EPBBPT4-V019Z	95582
0 281 002 389	EPBBPN3-A022Z	92949
0 281 002 389	EPBBPN3-A028Z	93277
0 281 002 394	EPBBPT4-V015Z	94877
0 281 002 399	EPBBPT4-V003Z	91742
0 281 002 401	EPBBPT4-V002Z	95912
0 281 002 437	EPBBPT4-V001Z	92565
0 281 002 438	EPBBPN3-A012Z	91308
0 281 002 487	EPBBPN3-V010Z	95936
0 281 002 510	EPBMBN3-V001Z	92099
0 281 002 514	EPBBPT4-V005Z	93700
0 281 002 552	EPBMBN3-V001Z	92099
0 281 002 566	EPBBPN3-V007Z	97073
0 281 002 573	EPBMPT4-V029Z	90509
0 281 002 593	EPBBPN3-V014Z	96895
0 281 002 616	EPBBPN3-V019Z	95201
0 281 002 680	EPBBPT4-V001Z	92565
0 281 002 709	EPBBPN4-V004Z	93057

Bosch	→ NTK	Stock
0 281 002 740	EPBBPN3-V016Z	92713
0 281 002 837	EPBBPT4-V002Z	95912
0 281 002 844	EPBMBN3-V001Z	92099
0 281 002 844	EPBBPT4-V001Z	92565
0 281 002 845	EPBBPT4-V001Z	92565
0 281 002 931	EPBBPN3-V007Z	97073
0 281 002 961	EPBBPN3-V016Z	92713
0 281 002 976	EPBBPT4-V002Z	95912
0 281 002 996	EPBBPN3-V007Z	97073
0 281 006 028	EPBBPT4-V001Z	92565
0 281 006 076	EPBBPT4-V001Z	92565
0 281 006 118	EPBBPT4-V001Z	92565
F 000 99P 003	EPBMPN3-A002Z	96249
F 000 99P 169	EPBMPN3-A003Z	92477
F 000 99P 218	EPBMPT4-V012Z	91940
F 000 99P 402	EPBMPT4-V004Z	92899
F 01C 600 070	EPBMPT4-V003Z	93266
F 01C 600 110	EPBBPT4-V001Z	92565
CONTINENTAL/VDO	→ NTK	Stock
5 WK 96820	EPBMPN3-V041Z	92257
5 WK 9693 Z	EPBMPT4-V011Z	91119
A2C 831 569 00	EPBMPT4-V002Z	94153
Delphi	→ NTK	Stock
PS10002	EPBMPN3-V005Z	93871
PS10002-11B1	EPBMPN3-V005Z	93871
PS10075	EPBMPN3-A003Z	92477
PS10075-11B1	EPBMPN3-A003Z	92477
PS10076-11B1	EPBMPN3-A036Z	95612
PS10082	EPBMPN3-A033Z	96422
PS10082-11B1	EPBMPN3-A033Z	96422
PS10084-11B1	EPBBPN3-A026Z	96088
PS10086-11B1	EPBMPN3-V006Z	97501
PS10094-12B1	EPBMPN3-A002Z	96249
PS10096-12B1	EPBMPN3-A035Z	92810
PS10098	EPBMPT4-D025Z	92358
PS10105-12B1	EPBMPN3-A009Z	92952
PS10107-12B1	EPBMPT4-V012Z	91940
PS10107-12B1	EPBMPT4-V003Z	93266
PS10117	EPBBPT4-V002Z	95912
PS10118	EPBBPT4-V003Z	91742
PS10119	EPBBPN4-V004Z	93057
PS10120	EPBBPN3-A001Z	94263
PS10121	EPBMPN3-V010Z	93991
PS10122	EPBMPT4-V002Z	94153
PS10123	EPBMPT4-D005Z	93653
PS10124	EPBBPT4-V010Z	91257
PS10125	EPBMPT4-A007Z	96755
PS10126	EPBMPN3-V008Z	90549
PS10127	EPBMBT4-D001Z	91628
PS10128	EPBMPT4-A001Z	93136
PS10129	EPBMPN3-A007Z	96754
PS10130	EPBBPN3-V007Z	97073

Delphi	→ NTK	Stock
PS10131	EPBMPN3-A028Z	93480
PS10131	EPBBPN3-A015Z	96911
PS10132	EPBMPT4-A017Z	96798
PS10133	EPBMPT4-V009Z	96309
PS10134	EPBBPN3-A003Z	91268
PS10135	EPBMPT4-V008Z	96201
PS10136	EPBMPN3-A004Z	90833
PS10136	EPBBPN3-A002Z	94523
PS10137	EPBBPT4-V013Z	91803
PS10138	EPBBPT4-A011Z	94601
PS10139	EPBBPN3-A005Z	90934
PS10140	EPBMPN3-A004Z	90833
PS10140	EPBBPN3-A002Z	94523
PS10141	EPBMBN3-V001Z	92099
PS10141	EPBBPN3-A015Z	96911
PS10142	EPBMPN3-V001Z	90037
PS10142	EPBMPN3-V005Z	93871
PS10144	EPBBPT4-V001Z	92565
PS10145	EPBBPN3-V010Z	95936
PS10146	EPBMPT4-V004Z	92899
PS10147	EPBMPN3-V013Z	94788
PS10148	EPBMPN3-V006Z	97501
PS10149	EPBMPN3-V030Z	92953
PS10150	EPBMPT4-V039Z	96769
PS10151	EPBBPT4-V007Z	94941
PS10152	EPBMPT4-V014Z	97115
PS10153	EPBBPN3-V029Z	92983
PS10154	EPBMPN3-V019Z	93061
PS10155	EPBMPN3-V017Z	91253
PS10156	EPBMPT4-A036Z	97175
PS10157	EPBMPN3-A027Z	90915
PS10158	EPBMPN3-A040Z	94558
PS10159	EPBBPN4-V014Z	93428
PS10160	EPBMPN4-V041Z	94063
PS10161	EPBBPT4-V002Z	95912
PS10161	EPBMPN4-V040Z	95972
PS10162	EPBMPT4-A030Z	96501
PS10163	EPBMBT4-A002Z	92144
PS10164	EPBBPN3-A004Z	97711
PS10165	EPBBPN3-A013Z	95023
PS10166	EPBBPN3-A027Z	92471
PS10167	EPBBPN3-V019Z	95201
PS10168	EPBMPN3-V022Z	91412
PS10169	EPBMPN3-A037Z	94170
PS10171	EPBMPN3-A020Z	96725
PS10172	EPBBPN3-V034Z	96381
PS10173	EPBBPN3-A006Z	91736
PS10175	EPBBPN3-V008Z	90842
PS10176	EPBBPT4-V009Z	95675
PS10177	EPBMPT4-V011Z	91119
PS10178	EPBBPT4-V015Z	94877
PS10179	EPBBPN3-A012Z	91308





Industry

Delphi	→ NTK	Stock
PS10180	EPBBPN3-A017Z	95311
PS10182	EPBBPT4-V010Z	91257
PS10186	EPBBPN3-A015Z	96911
PS10188	EPBMPT4-V037Z	92354
PS10189	EPBMPT4-V016Z	92071
PS10190	EPBBPT4-A016Z	95268
PS10192	EPBBPN3-A024Z	91449
PS10193	EPBMPT4-V015Z	95488
PS10197	EPBBPN3-A018Z	95753
PS10206	EPBBPT4-V001Z	92565
PS10207	EPBMPN3-A015Z	94611
PS10209	EPBMPT4-V026Z	91770
PS10210	EPBBPN3-V016Z	92713
PS10211	EPBMPN3-A014Z	90281
PS10212	EPBMPN4-A035Z	96317
PS10213	EPBBPN3-A031Z	95922
PS10214	EPBBPN3-A009Z	96930
PS10215	EPBBPT4-V006Z	96941
PS10216	EPBMPN4-V013Z	93089
PS10217	EPBMPT4-A020Z	97897
PS10220	EPBBPT4-V008Z	92801
PS10221	EPBMPT4-V018Z	95148
PS10225	EPBBPN3-V023Z	90603
PS10228	EPBBPN3-V014Z	96895
DENSO	→ NTK	Stock
0 798 002 990	EPBMPN3-R046Z	95625
0 798 003 000	EPBMPN3-R012Z	96590
0 798 003 260	EPBBPN3-A013Z	95023
0 798 005 410	EPBMPN3-A015Z	94611
0 798 007 050	EPBBPN3-A006Z	91736
0 798 007 661	EPBBPN3-A018Z	95753
0 798 007 670	EPBBPN3-A017Z	95311
0 798 009 150	EPBMPT4-A024Z	91744
0 798 009 180	EPBMPN3-V025Z	94855
0 798 009 200	EPBMBT4-A003Z	93024
1 007 984 770	EPBMPN3-A023Z	96241
1 007 985 012	EPBMPN3-A037Z	94170
1 007 985 540	EPBMPN3-A014Z	90281
1 007 985 870	EPBMPN3-A045Z	93151
110 212 841	EPBBPN3-A009Z	96930
74701 N 20	EPBMBN3-V004Z	90962
EPS	→ NTK	Stock
1.993.001	EPBMPN3-A003Z	92477
1.993.002	EPBMPN3-D029Z	95772
1.993.003	EPBMPN3-A002Z	96249
1.993.004	EPBMPN3-A033Z	96422
1.993.005	EPBMPN3-A007Z	96754
1.993.006	EPBBPN3-A025Z	97101
1.993.007	EPBMPN3-A036Z	95612
1.993.008	EPBMPN3-A043Z	92940
1.993.009	EPBBPN3-A027Z	92471
1.993.010	EPBMPN3-A009Z	92952

EPS	→ NTK	Stock
1.993.011	EPBMPN3-V005Z	93871
1.993.012	EPBMBT4-D001Z	91628
1.993.013	EPBBPN3-V034Z	96381
1.993.014	EPBBPN3-A015Z	96911
1.993.015	EPBMPN3-A027Z	90915
1.993.016	EPBBPN3-A022Z	92949
1.993.016	EPBBPN3-A028Z	93277
1.993.017	EPBBPN3-A033Z	96394
1.993.021	EPBMPN3-A035Z	92810
1.993.022	EPBBPN3-V010Z	95936
1.993.023	EPBMPN3-V001Z	90037
1.993.023	EPBMPN3-V005Z	93871
1.993.024	EPBMPN3-V006Z	97501
1.993.026	EPBMPN3-A015Z	94611
1.993.029	EPBBPN3-A013Z	95023
1.993.030	EPBBPN3-A003Z	91268
1.993.031	EPBMPN3-R046Z	95625
1.993.032	EPBMPN3-R012Z	96590
1.993.034	EPBBPN3-A001Z	94263
1.993.042	EPBMPN3-V031Z	92481
1.993.051	EPBMPN3-V013Z	94788
1.993.053	EPBMPN3-A034Z	92094
1.993.054	EPBMPN3-A028Z	93480
1.993.055	EPBMBN3-V001Z	92099
1.993.056	EPBMPN3-A020Z	96725
1.993.057	EPBBPN3-A026Z	96088
1.993.059	EPBBPN3-A032Z	96503
1.993.062	EPBMPN3-A040Z	94558
1.993.064	EPBBPN3-V008Z	90842
1.993.068	EPBMPN3-A023Z	96241
1.993.069	EPBMPN3-A037Z	94170
1.993.071	EPBMPT4-D025Z	92358
1.993.072	EPBMPT4-D005Z	93653
1.993.073	EPBBPT4-V015Z	94877
1.993.074	EPBMPT4-V011Z	91119
1.993.075	EPBBPT4-V002Z	95912
1.993.076	EPBMPT4-V002Z	94153
1.993.077	EPBMPT4-V015Z	95488
1.993.078	EPBBPT4-V013Z	91803
1.993.080	EPBMPT4-A001Z	93136
1.993.081	EPBMPT4-V012Z	91940
1.993.082	EPBBPT4-V001Z	92565
1.993.083	EPBBPT4-V003Z	91742
1.993.084	EPBMPT4-V004Z	92899
1.993.084	EPBMPT4-V008Z	96201
1.993.085	EPBMPT4-V022Z	90125
1.993.086	EPBMPT4-V037Z	92354
1.993.087	EPBMPT4-V009Z	96309
1.993.088	EPBMPT4-V044Z	96079
1.993.089	EPBBPT4-V021Z	97219
1.993.090	EPBMPT4-V008Z	96201
1.993.091	EPBMPT4-V003Z	93266



EPS	→ NTK	Stock
1.993.091	EPBMPT4-V010Z	96347
1.993.092	EPBBPT4-V010Z	91257
1.993.093	EPBMPT4-A036Z	97175
1.993.097	EPBMPT4-A007Z	96755
1.993.098	EPBMPT4-V039Z	96769
1.993.100	EPBMPT4-A017Z	96798
1.993.101	EPBMPN4-V040Z	95972
1.993.102	EPBBPN3-A002Z	94523
1.993.105	EPBMPN4-V041Z	94063
1.993.106	EPBMPN3-A004Z	90833
1.993.108	EPBMPN3-A014Z	90281
1.993.109	EPBMPT4-V026Z	91770
1.993.110	EPBBPT4-V005Z	93700
1.993.111	EPBMPN3-A045Z	93151
1.993.112	EPBBPN4-V014Z	93428
1.993.113	EPBBPN3-A003Z	91268
1.993.113	EPBBPN3-A006Z	91736
1.993.114	EPBBPN3-A012Z	91308
1.993.115	EPBBPN3-A020Z	91829
1.993.116	EPBBPN3-A004Z	97711
1.993.117	EPBBPN3-A005Z	90934
1.993.118	EPBMPN3-V030Z	92953
1.993.121	EPBBPN3-V007Z	97073
1.993.122	EPBBPN3-V014Z	96895
1.993.125	EPBBPT4-V008Z	92801
1.993.126	EPBMPT4-V016Z	92071
1.993.131	EPBBPT4-V007Z	94941
1.993.132	EPBMPT4-A030Z	96501
1.993.133	EPBMPN3-V022Z	91412
1.993.134	EPBBPN3-A017Z	95311
1.993.135	EPBMPN3-V010Z	93991
1.993.136	EPBBPN3-A018Z	95753
1.993.137	EPBBPT4-A016Z	95268
1.993.144	EPBBPN3-V021Z	95679
1.993.151	EPBMPN4-A035Z	96317
1.993.157	EPBMPN4-V013Z	93089
1.993.158	EPBMBT4-A002Z	92144
1.993.163	EPBMBN3-V004Z	90962
1.993.164	EPBBPN3-A024Z	91449
1.993.165	EPBBPN3-A011Z	91149
1.993.167	EPBBPN4-V004Z	93057
1.993.171	EPBMPT4-V038Z	94727
1.993.173	EPBBPN3-V019Z	95201
1.993.175	EPBMBN3-A003Z	90717
1.993.177	EPBBPN3-V016Z	92713
1.993.178	EPBMPT4-V014Z	97115
1.993.179	EPBBPN3-V023Z	90603
1.993.180	EPBMPT4-V018Z	95148
1.993.186	EPBBPT4-V009Z	95675
1.993.189	EPBMPN3-V026Z	94423
1.993.195	EPBMPN3-V017Z	91253
1.993.196	EPBMPN3-V041Z	92257

EPS	→ NTK	Stock
1.993.198	EPBMPN3-V024Z	93159
1.993.201	EPBMPN3-V032Z	94413
1.993.203	EPBMPT4-A020Z	97897
1.993.205	EPBBPT4-A011Z	94601
1.993.210	EPBMBN3-V002Z	94886
1.993.213	EPBMPN3-V025Z	94855
1.993.214	EPBMBN3-V005Z	90946
1.993.226	EPBMPN4-D019Z	91102
1.993.227	EPBMPT4-V021Z	97498
1.993.230	EPBMPT4-V027Z	93059
1.993.234	EPBBPN3-V029Z	92983
1.993.244	EPBMPN3-V019Z	93061
1.993.245	EPBMBT4-V004Z	96629
1.993.246	EPBMPT4-V029Z	90509
1.993.250	EPBBPN4-A020Z	92413
1.993.261	EPBMBT4-A003Z	93024
1.993.317	EPBMPT4-A024Z	91744
1.993.320	EPBMPN4-A023Z	91984
1.993.341	EPBMPT4-V028Z	93902
1.993.344	EPBMPT4-V031Z	94763
1.993.345	EPBMBN3-V006Z	94835
1.993.355	EPBMPN3-V008Z	90549
1.993.355	EPBBPN3-A031Z	95922
ERA	→ NTK	Stock
550080	EPBMPN3-A002Z	96249
550085	EPBMPT4-D005Z	93653
550086	EPBMPN3-V001Z	90037
550097	EPBMBN3-V001Z	92099
550098	EPBMPT4-V003Z	93266
550125	EPBMPT4-V012Z	91940
550130	EPBMPN3-A007Z	96754
550131	EPBMPN3-A009Z	92952
550132	EPBMBT4-D001Z	91628
550133	EPBMPT4-A001Z	93136
550136	EPBMPN3-A020Z	96725
550137	EPBBPN3-V034Z	96381
550140	EPBMPN3-A003Z	92477
550141	EPBMPN3-V005Z	93871
550142	EPBBPN3-A002Z	94523
550143	EPBMPN3-A004Z	90833
550147	EPBMPN3-A043Z	92940
550148	EPBMPN3-A035Z	92810
550152	EPBMPN3-V008Z	90549
550157	EPBMPT4-A017Z	96798
550158	EPBBPN3-A032Z	96503
550159	EPBMPT4-V002Z	94153
550160	EPBMPT4-V015Z	95488
550161	EPBMPT4-A036Z	97175
550162	EPBBPN3-A031Z	95922
550163	EPBMPT4-A007Z	96755
550164	EPBMPN4-A034Z	95507
550173	EPBBPN3-V014Z	96895





Industry

ERA	→ NTK	Stock
550194	EPBMPT4-V011Z	91119
550194	EPBMPT4-V004Z	92899
550237	EPBMPT4-D025Z	92358
550239	EPBBPN3-V034Z	96381
550239	EPBBPN3-A015Z	96911
550244	EPBBPT4-V001Z	92565
550257	EPBMPT4-V032Z	96108
550261	EPBBPT4-V013Z	91803
550262	EPBMPT4-V037Z	92354
550263	EPBBPN4-V014Z	93428
550265	EPBBPT4-V002Z	95912
550266	EPBBPN3-A012Z	91308
550271	EPBBPT4-V001Z	92565
550276	EPBMPN3-R012Z	96590
550303	EPBMPN3-V022Z	91412
550304	EPBMPN3-D029Z	95772
550325	EPBMPT4-V043Z	97765
550330	EPBMPN3-A016Z	96896
550338	EPBMPT4-V045Z	91802
550360	EPBBPN3-V034Z	96381
550362	EPBMPN3-A034Z	92094
550363	EPBMPN4-V040Z	95972
550364	EPBBPT4-V010Z	91257
550365	EPBMPT4-V008Z	96201
550366	EPBBPT4-V015Z	94877
550367	EPBMPN3-A028Z	93480
550389	EPBBPN3-V010Z	95936
550390	EPBMPN3-V042Z	92659
550391	EPBMPN3-V021Z	92226
550392	EPBMPN3-V011Z	94242
550392	EPBMPN3-V018Z	97066
550394	EPBMPT4-V039Z	96769
550395	EPBMPT4-V033Z	90173
550412	EPBBPN3-V021Z	95679
550413	EPBBPT4-A011Z	94601
550421	EPBMPT4-A020Z	97897
550422	EPBBPT4-A017Z	92559
550462	EPBBPN3-A018Z	95753
550491	EPBMPN4-D019Z	91102
550492	EPBMPN3-V017Z	91253
550493	EPBBPN3-V029Z	92983
550561	EPBMPN3-V011Z	94242
550569	EPBBPN3-A001Z	94263
550570	EPBMPT4-V008Z	96201
550600	EPBBPT4-V006Z	96941
550605	EPBMPN4-V013Z	93089
550606	EPBBPT4-V003Z	91742
550668	EPBBPN4-V004Z	93057
550669	EPBMPT4-A006Z	96115
550687	EPBBPN3-A020Z	91829
550701	EPBMPT4-V026Z	91770
550734	EPBBPT4-V001Z	92565

ERA	→ NTK	Stock
550736	EPBMPN3-V041Z	92257
550739	EPBBPT4-V012Z	96542
550749	EPBMPN3-V026Z	94423
550750	EPBBPN3-V030Z	94092
550752	EPBBPT4-V003Z	91742
550753	EPBBPT4-V001Z	92565
550756	EPBBPN3-V007Z	97073
550757	EPBBPN3-V019Z	95201
550759	EPBMPT4-V010Z	96347
550760	EPBBPT4-A016Z	95268
550766	EPBMPN3-V030Z	92953
550769	EPBMPT4-V018Z	95148
550778	EPBMBN3-A003Z	90717
550781	EPBMPN3-V010Z	93991
550781	EPBMPN3-V026Z	94423
550783	EPBBPN3-A006Z	91736
550806	EPBBPN3-V016Z	92713
550818	EPBMPT4-D042Z	91710
550820	EPBMPN3-A044Z	93056
550821	EPBBPT4-V009Z	95675
550889	EPBBPT4-V018Z	91887
550890	EPBBPT4-A011Z	94601
550891	EPBBPN3-A024Z	91449
550892	EPBBPN3-A011Z	91149
550893	EPBMPT4-V038Z	94727
550894	EPBMPN3-V019Z	93061
550895	EPBBPT4-V006Z	96941
550940	EPBBPN3-A017Z	95311
550969	EPBBPT4-V010Z	91257
550970	EPBBPT4-V001Z	92565
550980	EPBMPT4-V016Z	92071
551108	EPBBPN3-V023Z	90603
551109	EPBBPT4-V007Z	94941
551110	EPBMPT4-V014Z	97115
551172	EPBBPT4-V001Z	92565
551176	EPBBPT4-V002Z	95912
551200	EPBMPT4-V029Z	90509
551202	EPBMBT4-A003Z	93024
551205	EPBMPT4-A030Z	96501
550080A	EPBMPN3-A002Z	96249
550085A	EPBMPT4-D005Z	93653
550086A	EPBMPN3-V001Z	90037
550097A	EPBMBN3-V001Z	92099
550098A	EPBMPT4-V003Z	93266
550125A	EPBMPT4-V012Z	91940
550130A	EPBMPN3-A007Z	96754
550131A	EPBMPN3-A009Z	92952
550132A	EPBMBT4-D001Z	91628
550133A	EPBMPT4-A001Z	93136
550140A	EPBMPN3-A003Z	92477
550141A	EPBMPN3-V005Z	93871
550142A	EPBBPN3-A002Z	94523



ERA	→ NTK	Stock
550143A	EPBMPN3-A004Z	90833
550157A	EPBMPT4-A017Z	96798
550159A	EPBMPT4-V002Z	94153
550160A	EPBMPT4-V015Z	95488
550161A	EPBMPT4-A036Z	97175
550163A	EPBMPT4-A007Z	96755
550173A	EPBBPN3-V014Z	96895
550194A	EPBMPT4-V011Z	91119
550194A	EPBMPT4-V004Z	92899
550237A	EPBMPT4-D025Z	92358
550239A	EPBBPN3-V034Z	96381
550239A	EPBBPN3-A015Z	96911
550261A	EPBBPT4-V013Z	91803
550263A	EPBBPN4-V014Z	93428
550265A	EPBBPT4-V002Z	95912
550266A	EPBBPN3-A012Z	91308
550276A	EPBMPN3-R012Z	96590
550303A	EPBMPN3-V022Z	91412
550325A	EPBMPT4-V043Z	97765
550338A	EPBMPT4-V045Z	91802
550362A	EPBMPN3-A034Z	92094
550364A	EPBBPT4-V010Z	91257
550367A	EPBMPN3-A028Z	93480
550391A	EPBMPN3-V021Z	92226
550392A	EPBMPN3-V011Z	94242
550392A	EPBMPN3-V018Z	97066
550394A	EPBMPT4-V039Z	96769
550413A	EPBBPT4-A011Z	94601
550491A	EPBMPN4-D019Z	91102
550492A	EPBMPN3-V017Z	91253
550561A	EPBMPN3-V011Z	94242
550569A	EPBBPN3-A001Z	94263
550570A	EPBMPT4-V008Z	96201
550605A	EPBMPN4-V013Z	93089
550664A	EPBBPN3-A009Z	96930
550665A	EPBBPN3-A003Z	91268
550666A	EPBBPN3-A004Z	97711
550668A	EPBBPN4-V004Z	93057
550669A	EPBMPT4-A006Z	96115
550687A	EPBBPN3-A020Z	91829
550702A	EPBBPT4-V005Z	93700
550734A	EPBBPT4-V001Z	92565
550740A	EPBBPN3-V008Z	90842
550740A	EPBMPN3-V013Z	94788
550741A	EPBMPN3-V006Z	97501
550752A	EPBBPT4-V003Z	91742
550756A	EPBBPN3-V007Z	97073
550759A	EPBMPT4-V010Z	96347
550766A	EPBMPN3-V030Z	92953
550778A	EPBMBN3-A003Z	90717
550781A	EPBMPN3-V010Z	93991
550781A	EPBMPN3-V026Z	94423

ERA	→ NTK	Stock
550821A	EPBBPT4-V009Z	95675
550863A	EPBMPN4-A035Z	96317
550892A	EPBBPN3-A011Z	91149
550893A	EPBMPT4-V038Z	94727
550894A	EPBMPN3-V019Z	93061
550959A	EPBMPN3-D029Z	95772
550960A	EPBBPN3-A027Z	92471
550961A	EPBBPN3-A013Z	95023
550980A	EPBMPT4-V016Z	92071
551110A	EPBMPT4-V014Z	97115
551192A	EPBMBT4-V004Z	96629
551201A	EPBBPN3-A022Z	92949
551201A	EPBBPN3-A028Z	93277
551202A	EPBMBT4-A003Z	93024
551205A	EPBMPT4-A030Z	96501
551396A	EPBMPT4-V009Z	96309
551400A	EPBBPN3-A005Z	90934
551457A	EPBBPT4-V008Z	92801
551459A	EPBMPN3-V031Z	92481
551489A	EPBBPT4-V021Z	97219
551490A	EPBMPN3-A015Z	94611
551491A	EPBMBN3-V004Z	90962
551492A	EPBMPT4-V021Z	97498
551494A	EPBMPN3-A027Z	90915
551495A	EPBBPN3-A026Z	96088
551496A	EPBMBN3-V006Z	94835
551497A	EPBBPN3-A026Z	96088
Facet	→ NTK	Stock
10.3001	EPBMPN3-A003Z	92477
10.3002	EPBMPN3-D029Z	95772
10.3003	EPBMPN3-A002Z	96249
10.3004	EPBMPN3-A033Z	96422
10.3005	EPBMPN3-A007Z	96754
10.3006	EPBBPN3-A025Z	97101
10.3007	EPBMPN3-A036Z	95612
10.3008	EPBMPN3-A043Z	92940
10.3009	EPBBPN3-A027Z	92471
10.3010	EPBMPN3-A009Z	92952
10.3011	EPBMPN3-V005Z	93871
10.3012	EPBMBT4-D001Z	91628
10.3013	EPBBPN3-V034Z	96381
10.3014	EPBBPN3-A015Z	96911
10.3015	EPBMPN3-A027Z	90915
10.3016	EPBBPN3-A022Z	92949
10.3016	EPBBPN3-A028Z	93277
10.3017	EPBBPN3-A033Z	96394
10.3021	EPBMPN3-A035Z	92810
10.3022	EPBBPN3-V010Z	95936
10.3023	EPBMPN3-V001Z	90037
10.3023	EPBMPN3-V005Z	93871
10.3024	EPBMPN3-V006Z	97501
10.3026	EPBMPN3-A015Z	94611





Industry

Facet	→ NTK	Stock
10.3029	EPBBPN3-A013Z	95023
10.3030	EPBBPN3-A003Z	91268
10.3031	EPBMPN3-R046Z	95625
10.3032	EPBMPN3-R012Z	96590
10.3034	EPBBPN3-A001Z	94263
10.3042	EPBMPN3-V031Z	92481
10.3051	EPBMPN3-V013Z	94788
10.3053	EPBMPN3-A034Z	92094
10.3054	EPBMPN3-A028Z	93480
10.3055	EPBMBN3-V001Z	92099
10.3056	EPBMPN3-A020Z	96725
10.3057	EPBBPN3-A026Z	96088
10.3059	EPBBPN3-A032Z	96503
10.3062	EPBMPN3-A040Z	94558
10.3064	EPBBPN3-V008Z	90842
10.3068	EPBMPN3-A023Z	96241
10.3069	EPBMPN3-A037Z	94170
10.3071	EPBMPT4-D025Z	92358
10.3072	EPBMPT4-D005Z	93653
10.3073	EPBBPT4-V015Z	94877
10.3074	EPBMPT4-V011Z	91119
10.3075	EPBBPT4-V002Z	95912
10.3076	EPBMPT4-V002Z	94153
10.3077	EPBMPT4-V015Z	95488
10.3078	EPBBPT4-V013Z	91803
10.3080	EPBMPT4-A001Z	93136
10.3081	EPBMPT4-V012Z	91940
10.3082	EPBBPT4-V001Z	92565
10.3083	EPBBPT4-V003Z	91742
10.3084	EPBMPT4-V004Z	92899
10.3084	EPBMPT4-V008Z	96201
10.3085	EPBMPT4-V022Z	90125
10.3086	EPBMPT4-V037Z	92354
10.3087	EPBMPT4-V009Z	96309
10.3088	EPBMPT4-V044Z	96079
10.3089	EPBBPT4-V021Z	97219
10.3090	EPBMPT4-V008Z	96201
10.3091	EPBMPT4-V003Z	93266
10.3091	EPBMPT4-V010Z	96347
10.3092	EPBBPT4-V010Z	91257
10.3093	EPBMPT4-A036Z	97175
10.3097	EPBMPT4-A007Z	96755
10.3098	EPBMPT4-V039Z	96769
10.3100	EPBMPT4-A017Z	96798
10.3101	EPBMPN4-V040Z	95972
10.3102	EPBBPN3-A002Z	94523
10.3105	EPBMPN4-V041Z	94063
10.3106	EPBMPN3-A004Z	90833
10.3108	EPBMPN3-A014Z	90281
10.3109	EPBMPT4-V026Z	91770
10.3110	EPBBPT4-V005Z	93700
10.3111	EPBMPN3-A045Z	93151

Facet	→ NTK	Stock
10.3112	EPBBPN4-V014Z	93428
10.3113	EPBBPN3-A003Z	91268
10.3113	EPBBPN3-A006Z	91736
10.3114	EPBBPN3-A012Z	91308
10.3115	EPBBPN3-A020Z	91829
10.3116	EPBBPN3-A004Z	97711
10.3117	EPBBPN3-A005Z	90934
10.3118	EPBMPN3-V030Z	92953
10.3121	EPBBPN3-V007Z	97073
10.3122	EPBBPN3-V014Z	96895
10.3125	EPBBPT4-V008Z	92801
10.3126	EPBMPT4-V016Z	92071
10.3131	EPBBPT4-V007Z	94941
10.3132	EPBMPT4-A030Z	96501
10.3133	EPBMPN3-V022Z	91412
10.3134	EPBBPN3-A017Z	95311
10.3135	EPBMPN3-V010Z	93991
10.3136	EPBBPN3-A018Z	95753
10.3137	EPBBPT4-A016Z	95268
10.3144	EPBBPN3-V021Z	95679
10.3151	EPBMPN4-A035Z	96317
10.3157	EPBMPN4-V013Z	93089
10.3158	EPBMBT4-A002Z	92144
10.3163	EPBMBN3-V004Z	90962
10.3164	EPBBPN3-A024Z	91449
10.3165	EPBBPN3-A011Z	91149
10.3167	EPBBPN4-V004Z	93057
10.3171	EPBMPT4-V038Z	94727
10.3173	EPBBPN3-V019Z	95201
10.3175	EPBMBN3-A003Z	90717
10.3177	EPBBPN3-V016Z	92713
10.3178	EPBMPT4-V014Z	97115
10.3179	EPBBPN3-V023Z	90603
10.3180	EPBMPT4-V018Z	95148
10.3186	EPBBPT4-V009Z	95675
10.3189	EPBMPN3-V026Z	94423
10.3195	EPBMPN3-V017Z	91253
10.3196	EPBMPN3-V041Z	92257
10.3198	EPBMPN3-V024Z	93159
10.3201	EPBMPN3-V032Z	94413
10.3203	EPBMPT4-A020Z	97897
10.3205	EPBBPT4-A011Z	94601
10.3210	EPBMBN3-V002Z	94886
10.3213	EPBMPN3-V025Z	94855
10.3214	EPBMBN3-V005Z	90946
10.3226	EPBMPN4-D019Z	91102
10.3227	EPBMPT4-V021Z	97498
10.3230	EPBMPT4-V027Z	93059
10.3234	EPBBPN3-V029Z	92983
10.3244	EPBMPN3-V019Z	93061
10.3245	EPBMBT4-V004Z	96629
10.3246	EPBMPT4-V029Z	90509



Facet	→ NTK	Stock
10.3250	EPBBPN4-A020Z	92413
10.3261	EPBMBT4-A003Z	93024
10.3317	EPBMPT4-A024Z	91744
10.3320	EPBMPN4-A023Z	91984
10.3341	EPBMPT4-V028Z	93902
10.3344	EPBMPT4-V031Z	94763
10.3345	EPBMBN3-V006Z	94835
10.3355	EPBMPN3-V008Z	90549
10.3355	EPBBPN3-A031Z	95922
FAE	→ NTK	Stock
15001	EPBMPN3-A003Z	92477
15002	EPBMPN3-A033Z	96422
15003	EPBBPN3-A025Z	97101
15005	EPBBPN3-A026Z	96088
15006	EPBMPN3-A002Z	96249
15007	EPBBPT4-V002Z	95912
15008	EPBBPN3-A033Z	96394
15009	EPBMPN3-A007Z	96754
15011	EPBMPN3-A020Z	96725
15012	EPBMPN3-A009Z	92952
15013	EPBMPN3-V005Z	93871
15014	EPBMPN3-A027Z	90915
15015	EPBBPN3-A022Z	92949
15016	EPBMPN3-V001Z	90037
15017	EPBBPN3-A003Z	91268
15018	EPBMPN3-V013Z	94788
15019	EPBMBN3-V001Z	92099
15019	EPBBPN3-A015Z	96911
15021	EPBMPN3-V022Z	91412
15022	EPBMPN3-V008Z	90549
15023	EPBBPN3-V008Z	90842
15024	EPBBPN3-A009Z	96930
15025	EPBMPN3-A004Z	90833
15026	EPBBPN4-V014Z	93428
15027	EPBBPN3-A006Z	91736
15028	EPBBPN3-A004Z	97711
15029	EPBBPN3-A005Z	90934
15030	EPBMBT4-D001Z	91628
15031	EPBMPT4-D025Z	92358
15032	EPBBPT4-V015Z	94877
15033	EPBMPT4-D005Z	93653
15034	EPBMPT4-V011Z	91119
15035	EPBMPT4-A001Z	93136
15036	EPBBPT4-V001Z	92565
15037	EPBBPT4-V003Z	91742
15038	EPBMPT4-V004Z	92899
15038	EPBMPT4-V008Z	96201
15039	EPBMPT4-A007Z	96755
15040	EPBMPT4-A030Z	96501
15041	EPBMPT4-V003Z	93266
15041	EPBMPT4-V010Z	96347
15042	EPBMPN4-V013Z	93089

FAE	→ NTK	Stock
15043	EPBMPT4-V008Z	96201
15044	EPBBPT4-V010Z	91257
15045	EPBBPN4-V004Z	93057
15046	EPBBPN3-A001Z	94263
15047	EPBMPN3-A035Z	92810
15048	EPBBPN3-A027Z	92471
15049	EPBMPT4-A036Z	97175
15050	EPBMPT4-A017Z	96798
15051	EPBBPN3-A013Z	95023
15052	EPBBPN3-A020Z	91829
15053	EPBBPN3-A012Z	91308
15054	EPBMPN3-A028Z	93480
15055	EPBBPN3-A015Z	96911
15056	EPBBPN3-V010Z	95936
15057	EPBBPN3-V034Z	96381
15058	EPBMPN3-A040Z	94558
15059	EPBMPN3-A034Z	92094
15060	EPBMPN4-V040Z	95972
15061	EPBMPN4-V041Z	94063
15062	EPBMPT4-V022Z	90125
15062	EPBBPN3-A003Z	91268
15063	EPBMPT4-V044Z	96079
15064	EPBBPT4-V008Z	92801
15065	EPBMPT4-V037Z	92354
15066	EPBMPT4-V009Z	96309
15067	EPBBPN3-V019Z	95201
15068	EPBBPN3-V007Z	97073
15069	EPBMPT4-V002Z	94153
15070	EPBMPT4-V015Z	95488
15071	EPBMPT4-V012Z	91940
15072	EPBBPT4-V021Z	97219
15073	EPBMPT4-V026Z	91770
15074	EPBBPN3-A002Z	94523
15075	EPBBPT4-A016Z	95268
15076	EPBMPN3-R012Z	96590
15077	EPBMPN3-R046Z	95625
15078	EPBMPN3-A015Z	94611
15079	EPBMPN3-V006Z	97501
15080	EPBBPN3-A031Z	95922
15081	EPBBPN3-A032Z	96503
15082	EPBBPT4-V013Z	91803
15083	EPBBPT4-V009Z	95675
15084	EPBMPN3-A045Z	93151
15085	EPBMPN3-A037Z	94170
15086	EPBMPN3-A023Z	96241
15087	EPBMPN3-A014Z	90281
15088	EPBMPN4-A035Z	96317
15089	EPBMBN3-A003Z	90717
15090	EPBMPN4-D019Z	91102
15091	EPBBPN3-A024Z	91449
15092	EPBBPN3-V016Z	92713
15093	EPBBPT4-V019Z	95582





Industry

FAE	→ NTK	Stock
15094	EPBBPT4-V012Z	96542
15097	EPBBPT4-V005Z	93700
15098	EPBBPT4-A011Z	94601
15099	EPBMPN3-V017Z	91253
15100	EPBBPN3-V029Z	92983
15101	EPBBPT4-V024Z	92064
15103	EPBBPN3-A011Z	91149
15104	EPBMPT4-V010Z	96347
15106	EPBBPN3-V014Z	96895
15107	EPBBPN3-A017Z	95311
15108	EPBBPN3-A018Z	95753
15109	EPBMBT4-A002Z	92144
15110	EPBMBT4-V004Z	96629
15111	EPBMPT4-V029Z	90509
15112	EPBMPN3-A016Z	96896
15113	EPBMPT4-A020Z	97897
15114	EPBBPT4-A017Z	92559
15115	EPBMPN4-A034Z	95507
15116	EPBMPT4-V033Z	90173
15117	EPBMPN3-V021Z	92226
15118	EPBMPT4-V039Z	96769
15119	EPBMPT4-V043Z	97765
15120	EPBBPN3-A001Z	94263
15121	EPBMPN3-V042Z	92659
15122	EPBMPN3-V011Z	94242
15122	EPBMPN3-V018Z	97066
15123	EPBBPN3-V023Z	90603
15124	EPBBPT4-V007Z	94941
15125	EPBMPN3-V030Z	92953
15126	EPBMPT4-V014Z	97115
15127	EPBMPN3-V010Z	93991
15127	EPBMPN3-V026Z	94423
15128	EPBBPN3-V021Z	95679
15129	EPBMPN3-V019Z	93061
15130	EPBBPT4-V006Z	96941
15131	EPBBPN3-A028Z	93277
15132	EPBMBT4-A003Z	93024
15133	EPBBPT4-V018Z	91887
15134	EPBBPN3-V030Z	94092
15135	EPBMPN3-V031Z	92481
15136	EPBMBN3-V002Z	94886
15138	EPBBPN4-A020Z	92413
15139	EPBMPN3-A038Z	94914
15140	EPBMPN3-A039Z	97513
15143	EPBMPN3-V041Z	92257
15144	EPBMPT4-V027Z	93059
15145	EPBMPT4-V003Z	93266
15147	EPBMBN3-V006Z	94835
15155	EPBMBN3-V005Z	90946
15156	EPBMPN3-V024Z	93159
15157	EPBMPN3-V032Z	94413
15158	EPBMPN3-V025Z	94855

FAE	→ NTK	Stock
15160	EPBMBN3-V004Z	90962
15161	EPBMPN3-A044Z	93056
15163	EPBMPT4-V016Z	92071
15165	EPBMPT4-V018Z	95148
15166	EPBMPN3-A052Z	93614
15172	EPBMPT4-V038Z	94727
15178	EPBMPN4-A023Z	91984
15181	EPBMPT4-V028Z	93902
15193	EPBMPT4-V021Z	97498
15206	EPBMPT4-A024Z	91744
15212	EPBMPT4-A006Z	96115
15213	EPBMPT4-V031Z	94763
15216	EPBMPT4-V032Z	96108
Febi	→ NTK	Stock
27186	EPBMPT4-D005Z	93653
30677	EPBMPT4-A030Z	96501
30860	EPBMPT4-V009Z	96309
30896	EPBMPN3-A015Z	94611
36116	EPBBPT4-V002Z	95912
36623	EPBMPT4-V011Z	91119
36623	EPBMPT4-V004Z	92899
36858	EPBMPN3-A002Z	96249
36965	EPBBPN3-A005Z	90934
36966	EPBBPN3-A004Z	97711
37055	EPBBPT4-V001Z	92565
37056	EPBMPN3-A004Z	90833
37057	EPBBPN3-A009Z	96930
37740	EPBBPN3-A001Z	94263
37880	EPBMPT4-A001Z	93136
38277	EPBMPN3-A040Z	94558
38293	EPBMBN3-A003Z	90717
38493	EPBMPT4-V003Z	93266
38493	EPBMPT4-V010Z	96347
38494	EPBBPN3-A002Z	94523
44242	EPBMPN4-V013Z	93089
44466	EPBBPN3-A011Z	91149
45079	EPBMPT4-V008Z	96201
45255	EPBMPT4-V012Z	91940
45473	EPBBPT4-V012Z	96542
45923	EPBMPN3-A007Z	96754
45927	EPBMPN3-A009Z	92952
45935	EPBBPN3-A003Z	91268
45935	EPBBPN3-A006Z	91736
45936	EPBMPN3-A020Z	96725
49441	EPBBPN3-V007Z	97073
49634	EPBBPN4-V004Z	93057
100657	EPBMPN3-V010Z	93991
100987	EPBBPN3-A015Z	96911
101453	EPBBPT4-V005Z	93700
102325	EPBMBN3-V001Z	92099
103603	EPBBPN3-V016Z	92713
103635	EPBBPN3-V014Z	96895



Febi	→ NTK	Stock
103922	EPBBPT4-V009Z	95675
105735	EPBMPT4-A017Z	96798
105987	EPBMPN3-V008Z	90549
105988	EPBBPN3-V010Z	95936
105990	EPBBPN3-V021Z	95679
105991	EPBBPT4-V008Z	92801
106018	EPBMPT4-A007Z	96755
106021	EPBMBT4-A003Z	93024
106023	EPBBPT4-V003Z	91742
106026	EPBMPT4-V002Z	94153
106036	EPBMPT4-A020Z	97897
106068	EPBMBT4-A002Z	92144
106073	EPBMPN3-A028Z	93480
106080	EPBBPN4-A020Z	92413
106483	EPBMPN3-V025Z	94855
106732	EPBBPN3-V029Z	92983
106967	EPBMPN3-V001Z	90037
106967	EPBMPN3-V005Z	93871
107993	EPBMPT4-A036Z	97175
109557	EPBBPT4-V024Z	92064
170216	EPBBPN4-V014Z	93428
171781	EPBMBN3-V002Z	94886
173804	EPBMPN4-A023Z	91984
174424	EPBMPN3-V019Z	93061
174448	EPBMPN4-A035Z	96317
174453	EPBBPT4-A011Z	94601
175182	EPBMPN3-A014Z	90281
FISPA	→ NTK	Stock
84334	EPBMPN3-A052Z	93614
Hella	→ NTK	Stock
6PP 009 400-011	EPBMPN3-V001Z	90037
6PP 009 400-011	EPBMPN3-V005Z	93871
6PP 009 400-051	EPBBPT4-V006Z	96941
6PP 009 400-111	EPBMBN3-V001Z	92099
6PP 009 400-161	EPBMPN3-A007Z	96754
6PP 009 400-171	EPBMPN3-V013Z	94788
6PP 009 400-181	EPBMPN3-V008Z	90549
6PP 009 400-201	EPBBPN3-V008Z	90842
6PP 009 400-211	EPBMPN3-A002Z	96249
6PP 009 400-221	EPBMPN3-A003Z	92477
6PP 009 400-231	EPBMPN3-D029Z	95772
6PP 009 400-241	EPBMPT4-V011Z	91119
6PP 009 400-241	EPBMPT4-V004Z	92899
6PP 009 400-241	EPBMPT4-V008Z	96201
6PP 009 400-251	EPBBPT4-V002Z	95912
6PP 009 400-261	EPBMPT4-D005Z	93653
6PP 009 400-281	EPBMPN3-V001Z	90037
6PP 009 400-281	EPBMPN3-V005Z	93871
6PP 009 400-291	EPBBPT4-V001Z	92565
6PP 009 400-301	EPBMPT4-A001Z	93136
6PP 009 400-311	EPBMPT4-V003Z	93266
6PP 009 400-311	EPBMPT4-V010Z	96347

Hella	→ NTK	Stock
6PP 009 400-321	EPBBPN3-A004Z	97711
6PP 009 400-331	EPBMPT4-V015Z	95488
6PP 009 400-341	EPBMPT4-V012Z	91940
6PP 009 400-351	EPBMPN3-A015Z	94611
6PP 009 400-361	EPBMPT4-A030Z	96501
6PP 009 400-371	EPBMPN3-R012Z	96590
6PP 009 400-381	EPBMPT4-V002Z	94153
6PP 009 400-401	EPBBPN3-A012Z	91308
6PP 009 400-411	EPBBPN3-A003Z	91268
6PP 009 400-421	EPBMPT4-V037Z	92354
6PP 009 400-431	EPBMPN3-V006Z	97501
6PP 009 400-441	EPBBPN4-V004Z	93057
6PP 009 400-451	EPBBPN3-V034Z	96381
6PP 009 400-461	EPBMPN3-A028Z	93480
6PP 009 400-471	EPBBPT4-V003Z	91742
6PP 009 400-481	EPBMBT4-D001Z	91628
6PP 009 400-491	EPBMPT4-A007Z	96755
6PP 009 400-501	EPBMPT4-V008Z	96201
6PP 009 400-511	EPBMPT4-D025Z	92358
6PP 009 400-521	EPBBPN3-A001Z	94263
6PP 009 400-531	EPBMPT4-A036Z	97175
6PP 009 400-541	EPBMPN4-V013Z	93089
6PP 009 400-551	EPBBPN4-V014Z	93428
6PP 009 400-561	EPBBPN3-A005Z	90934
6PP 009 400-571	EPBBPN3-A009Z	96930
6PP 009 400-581	EPBBPT4-V008Z	92801
6PP 009 400-591	EPBBPT4-V013Z	91803
6PP 009 400-601	EPBMPT4-A017Z	96798
6PP 009 400-611	EPBBPT4-A011Z	94601
6PP 009 400-621	EPBBPN3-A003Z	91268
6PP 009 400-621	EPBBPN3-A006Z	91736
6PP 009 400-631	EPBMPT4-A020Z	97897
6PP 009 400-641	EPBBPN3-A027Z	92471
6PP 009 400-651	EPBMPN3-A009Z	92952
6PP 009 400-661	EPBMPN3-A040Z	94558
6PP 009 400-671	EPBMPT4-V022Z	90125
6PP 009 400-681	EPBMPT4-V009Z	96309
6PP 009 400-701	EPBBPN3-V007Z	97073
6PP 009 400-711	EPBMPN3-V022Z	91412
6PP 009 400-721	EPBBPN3-A018Z	95753
6PP 009 400-731	EPBBPN3-A024Z	91449
6PP 009 400-741	EPBBPN3-V019Z	95201
6PP 009 400-751	EPBBPN3-V016Z	92713
6PP 009 400-771	EPBBPN3-A013Z	95023
6PP 009 400-781	EPBMPN4-V040Z	95972
6PP 009 400-901	EPBBPN3-A022Z	92949
6PP 009 400-901	EPBBPN3-A031Z	95922
6PP 009 400-911	EPBBPN3-A031Z	95922
6PP 009 400-921	EPBMPN3-A035Z	92810
6PP 009 400-931	EPBBPN3-A032Z	96503
6PP 009 400-941	EPBBPT4-V021Z	97219
6PP 009 400-951	EPBBPT4-V010Z	91257





Industry

Hella	→ NTK	Stock
6PP 009 400-961	EPBMPN3-A014Z	90281
6PP 009 400-971	EPBMPT4-V026Z	91770
6PP 009 400-991	EPBMPT4-V016Z	92071
6PP 009 409-041	EPBBPN3-V014Z	96895
6PP 013 112-001	EPBMPN4-A035Z	96317
6PP 013 112-011	EPBMBT4-A002Z	92144
6PP 013 112-021	EPBBPT4-V010Z	91257
6PP 013 112-031	EPBMPT4-V018Z	95148
6PP 013 112-041	EPBBPT4-V009Z	95675
6PP 013 112-051	EPBMPN3-V041Z	92257
6PP 013 112-061	EPBMPT4-V021Z	97498
6PP 013 112-071	EPBMPT4-V027Z	93059
6PP 013 112-081	EPBMPN3-V019Z	93061
6PP 013 112-091	EPBMPN4-A023Z	91984
6PP 013 112-211	EPBMPT4-V038Z	94727
6PP 013 112-241	EPBMPN3-A020Z	96725
6PP 013 112-261	EPBBPN3-V014Z	96895
6PP 013 400-001	EPBBPT4-V010Z	91257
6PP 013 400-031	EPBBPT4-V024Z	92064
6PP 013 400-041	EPBBPT4-V024Z	92064
6PP 358 152-011	EPBMBT4-D001Z	91628
6PP 358 152-021	EPBMPN3-V030Z	92953
6PP 358 152-031	EPBMPT4-V039Z	96769
6PP 358 152-041	EPBMPN3-V017Z	91253
6PP 358 152-051	EPBBPN3-V029Z	92983
6PP 358 152-061	EPBMPN3-A004Z	90833
6PP 358 152-071	EPBBPN3-A002Z	94523
6PP 358 152-091	EPBMPN3-V017Z	91253
6PP 358 152-101	EPBMPN3-V025Z	94855
Hitachi	→ NTK	Stock
138208	EPBMPN3-V005Z	93871
138215	EPBMPN3-V001Z	90037
2508148	EPBMPN3-A052Z	93614
2508162	EPBMPN3-A051Z	92149
2508195	EPBMPN3-A050Z	96018
2508196	EPBMPN3-A049Z	93927
2508197	EPBMPN3-A048Z	94778
2508198	EPBMPT4-A046Z	92256
2508202	EPBMPN3-A047Z	90252
138148	EPBMPN3-A052Z	93614
138162	EPBMPN3-A051Z	92149
138195	EPBMPN3-A050Z	96018
138196	EPBMPN3-A049Z	93927
138197	EPBMPN3-A048Z	94778
138198	EPBMPT4-A046Z	92256
138202	EPBMPN3-A047Z	90252
138203	EPBMPT4-V014Z	97115
138204	EPBBPT4-V001Z	92565
138205	EPBMPN3-A003Z	92477
138207	EPBMPT4-D025Z	92358
138208	EPBMPN3-V001Z	90037
138209	EPBMPT4-A001Z	93136

Hitachi	→ NTK	Stock
138211	EPBMPN3-A004Z	90833
138212	EPBMPN3-V017Z	91253
138213	EPBMBT4-D001Z	91628
138214	EPBBPT4-V002Z	95912
138215	EPBMPN3-V005Z	93871
138216	EPBBPN3-A018Z	95753
138217	EPBMPT4-V039Z	96769
138218	EPBMPT4-V038Z	94727
138219	EPBMPN3-V019Z	93061
138220	EPBBPN3-A004Z	97711
138221	EPBMPN3-V022Z	91412
138222	EPBMPN3-V008Z	90549
138223	EPBBPN3-A017Z	95311
138224	EPBBPN3-A003Z	91268
138224	EPBBPN3-A006Z	91736
138225	EPBMPN3-R012Z	96590
138227	EPBMPT4-V003Z	93266
138227	EPBMPT4-V010Z	96347
138228	EPBMPN3-A002Z	96249
138229	EPBBPT4-V003Z	91742
138230	EPBBPN3-A001Z	94263
138232	EPBMPN3-A007Z	96754
138233	EPBMPT4-A007Z	96755
138234	EPBBPN3-V007Z	97073
138235	EPBMPT4-V021Z	97498
138236	EPBMPT4-V018Z	95148
138237	EPBMPT4-A030Z	96501
138238	EPBMPN4-D019Z	91102
138239	EPBMPT4-A036Z	97175
138240	EPBBPT4-V010Z	91257
138241	EPBMBN3-V001Z	92099
138242	EPBMPT4-A017Z	96798
138243	EPBBPN3-A012Z	91308
138244	EPBBPN3-A011Z	91149
138245	EPBBPN3-A009Z	96930
138246	EPBBPN4-V004Z	93057
138247	EPBBPN3-V029Z	92983
HOFFER	→ NTK	Stock
7472333	EPBMPN3-A052Z	93614
Intermotor	→ NTK	Stock
16705	EPBMBN3-V002Z	94886
16708	EPBMPT4-V028Z	93902
16711	EPBMPN3-V019Z	93061
16712	EPBBPN3-V029Z	92983
16713	EPBMPN3-V017Z	91253
16714	EPBMPT4-V018Z	95148
16716	EPBMPN4-A035Z	96317
16717	EPBBPT4-V022Z	90386
16718	EPBBPN3-A018Z	95753
16719	EPBMBT4-V004Z	96629
16720	EPBMPN3-A016Z	96896
16722	EPBMBN3-A003Z	90717



Intermotor	→ NTK	Stock
16723	EPBBPT4-V012Z	96542
16724	EPBMBN3-V004Z	90962
16725	EPBMPN3-V024Z	93159
16726	EPBBPN4-A020Z	92413
16728	EPBMPN3-V042Z	92659
16729	EPBBPN3-V023Z	90603
16730	EPBBPT4-V007Z	94941
16731	EPBMPN3-V030Z	92953
16732	EPBMPT4-V014Z	97115
16733	EPBBPT4-V006Z	96941
16734	EPBBPT4-V018Z	91887
16735	EPBMPT4-V016Z	92071
16738	EPBMPN3-V032Z	94413
16739	EPBMPN3-V025Z	94855
16740	EPBMBN3-V005Z	90946
16741	EPBMPT4-V021Z	97498
16742	EPBMPT4-V027Z	93059
16744	EPBMBT4-A003Z	93024
16745	EPBMPT4-A024Z	91744
16746	EPBMPN4-A023Z	91984
16747	EPBMPT4-V031Z	94763
16748	EPBMBN3-V006Z	94835
16749	EPBBPN3-A031Z	95922
16750	EPBBPN3-V030Z	94092
16751	EPBMPN3-A039Z	97513
16800	EPBMPN3-A003Z	92477
16801	EPBMPN3-D029Z	95772
16802	EPBMPN3-A002Z	96249
16803	EPBBPN3-A033Z	96394
16805	EPBMPN3-A035Z	92810
16806	EPBMPN3-A043Z	92940
16807	EPBMPN3-A033Z	96422
16809	EPBMPT4-V004Z	92899
16809	EPBMPT4-V008Z	96201
16810	EPBMPN3-A007Z	96754
16811	EPBBPN3-A025Z	97101
16812	EPBMPN3-A036Z	95612
16813	EPBMPN3-A009Z	92952
16814	EPBMPN3-V005Z	93871
16815	EPBMBT4-D001Z	91628
16816	EPBBPN3-V034Z	96381
16817	EPBBPN3-A015Z	96911
16818	EPBMPN3-A027Z	90915
16819	EPBBPN3-A022Z	92949
16821	EPBMPN3-V001Z	90037
16822	EPBMPN3-V006Z	97501
16823	EPBBPN3-A013Z	95023
16824	EPBBPN3-A003Z	91268
16825	EPBBPN3-A001Z	94263
16826	EPBMPN3-V013Z	94788
16827	EPBMPN3-A034Z	92094
16828	EPBMPN3-A028Z	93480

Intermotor	→ NTK	Stock
16829	EPBMBN3-V001Z	92099
16830	EPBMPN3-A020Z	96725
16831	EPBBPN3-A026Z	96088
16832	EPBMPN3-V008Z	90549
16833	EPBBPN3-A032Z	96503
16834	EPBMPN3-A040Z	94558
16835	EPBBPN3-V008Z	90842
16836	EPBMPN3-A023Z	96241
16837	EPBMPN3-A037Z	94170
16838	EPBMPT4-D025Z	92358
16839	EPBMPT4-V002Z	94153
16840	EPBMPT4-V015Z	95488
16841	EPBBPN3-A002Z	94523
16842	EPBBPN3-A012Z	91308
16843	EPBBPN3-A020Z	91829
16844	EPBBPN3-A004Z	97711
16845	EPBBPN3-A005Z	90934
16846	EPBMPT4-D005Z	93653
16847	EPBBPT4-V015Z	94877
16848	EPBMPT4-V008Z	96201
16850	EPBMPT4-A001Z	93136
16851	EPBMPT4-A007Z	96755
16852	EPBBPT4-V010Z	91257
16853	EPBMPN4-V040Z	95972
16854	EPBBPN3-A009Z	96930
16855	EPBMPN3-A004Z	90833
16856	EPBMPN3-A014Z	90281
16857	EPBMPN3-A045Z	93151
16858	EPBMPN3-V022Z	91412
16859	EPBMPT4-V003Z	93266
16859	EPBMPT4-V010Z	96347
16860	EPBMPT4-A036Z	97175
16861	EPBMPN4-V041Z	94063
16862	EPBMPN3-R046Z	95625
16863	EPBMPN3-R012Z	96590
16864	EPBMPN4-A034Z	95507
16865	EPBMPT4-V032Z	96108
16866	EPBBPN3-A027Z	92471
16867	EPBMPT4-V011Z	91119
16868	EPBBPT4-V013Z	91803
16869	EPBBPT4-V001Z	92565
16870	EPBBPT4-V003Z	91742
16871	EPBMPT4-V022Z	90125
16872	EPBMPT4-V037Z	92354
16873	EPBMPT4-V009Z	96309
16874	EPBMPT4-V044Z	96079
16875	EPBBPT4-V021Z	97219
16876	EPBMPT4-V003Z	93266
16877	EPBMPT4-V026Z	91770
16878	EPBBPT4-V008Z	92801
16879	EPBMPT4-A030Z	96501
16880	EPBMPT4-V012Z	91940



Intermotor	→ NTK	Stock
16881	EPBMPT4-A017Z	96798
16882	EPBBPT4-V002Z	95912
16884	EPBBPN3-A006Z	91736
16885	EPBBPT4-V009Z	95675
16886	EPBBPN3-V021Z	95679
16887	EPBBPT4-A017Z	92559
16888	EPBBPT4-A011Z	94601
16889	EPBMPT4-A020Z	97897
16890	EPBMPN3-A015Z	94611
16891	EPBBPN4-V014Z	93428
16892	EPBMPT4-A006Z	96115
16893	EPBMPT4-V038Z	94727
16894	EPBMPT4-V029Z	90509
16895	EPBMPT4-V010Z	96347
16896	EPBBPN3-A024Z	91449
16897	EPBMPN3-V026Z	94423
16898	EPBBPN3-V016Z	92713
16902	EPBMPT4-V043Z	97765
16904	EPBBPN3-V019Z	95201
16906	EPBMPT4-D042Z	91710
16907	EPBMPN3-A044Z	93056
16909	EPBMPN3-V010Z	93991
16910	EPBMPN4-V013Z	93089
16912	EPBMPT4-V010Z	96347
16913	EPBBPT4-A016Z	95268
16916	EPBBPN3-A011Z	91149
16917	EPBMPN3-A044Z	93056
16918	EPBBPN3-V014Z	96895
16920	EPBBPN4-V004Z	93057
16921	EPBMPT4-V045Z	91802
16922	EPBMPN3-V021Z	92226
16923	EPBMPN3-V011Z	94242
16923	EPBMPN3-V018Z	97066
16924	EPBMPT4-V039Z	96769
16925	EPBMPT4-V033Z	90173
16927	EPBBPN3-V007Z	97073
16928	EPBBPN3-V010Z	95936
16930	EPBMPN3-V031Z	92481
16931	EPBMBT4-A002Z	92144
16932	EPBMPN3-V041Z	92257
MEATDORIA	→ NTK	Stock
9113	EPBMPT4-V029Z	90509
9273	EPBBPN3-V010Z	95936
82051	EPBMPN3-A002Z	96249
82052	EPBMPN3-A003Z	92477
82053	EPBMPN3-D029Z	95772
82100	EPBMPT4-D025Z	92358
82101	EPBMPN3-A009Z	92952
82111	EPBMPT4-V004Z	92899
82117	EPBMPN3-V001Z	90037
82117	EPBMPN3-V005Z	93871
82118	EPBMPN3-A007Z	96754

MEATDORIA	→ NTK	Stock
82119	EPBMPT4-V012Z	91940
82120	EPBMPT4-V003Z	93266
82121	EPBMBT4-D001Z	91628
82123	EPBMBN3-V001Z	92099
82126	EPBBPN3-V034Z	96381
82130	EPBMPT4-V032Z	96108
82133	EPBMPN3-A043Z	92940
82134	EPBMPN3-A027Z	90915
82135	EPBMPN3-A020Z	96725
82143	EPBBPT4-V001Z	92565
82144	EPBMPN3-V001Z	90037
82144	EPBMPT4-V029Z	90509
82145	EPBMPT4-A001Z	93136
82146	EPBMPT4-A007Z	96755
82147	EPBMPT4-A036Z	97175
82148	EPBBPT4-V010Z	91257
82149	EPBMPT4-D005Z	93653
82150	EPBMPT4-V011Z	91119
82151	EPBMPT4-V008Z	96201
82152	EPBMPN4-V040Z	95972
82153	EPBMPN4-V013Z	93089
82154	EPBMPN3-A004Z	90833
82155	EPBBPN3-A009Z	96930
82156	EPBMPN3-A004Z	90833
82156	EPBBPN3-A002Z	94523
82157	EPBMPN3-V006Z	97501
82158	EPBBPN3-A013Z	95023
82159	EPBMBT4-D001Z	91628
82159	EPBBPT4-V003Z	91742
82160	EPBMPN3-A035Z	92810
82161	EPBBPN3-A003Z	91268
82161	EPBBPN3-A006Z	91736
82162	EPBBPN3-A001Z	94263
82163	EPBBPN3-V008Z	90842
82163	EPBMPN3-V013Z	94788
82164	EPBMPT4-V002Z	94153
82165	EPBMPT4-V015Z	95488
82166	EPBBPN3-A012Z	91308
82167	EPBBPN3-A020Z	91829
82168	EPBBPN3-A004Z	97711
82169	EPBBPN3-A005Z	90934
82170	EPBMPN4-V041Z	94063
82171	EPBMPN3-V013Z	94788
82172	EPBMPN3-A028Z	93480
82195	EPBBPN3-A027Z	92471
82196	EPBBPN3-A015Z	96911
82197	EPBMPN3-A034Z	92094
82198	EPBMPN3-A040Z	94558
82199	EPBBPT4-V015Z	94877
82200	EPBBPN3-A031Z	95922
82210	EPBBPN3-A025Z	97101
82211	EPBBPT4-V001Z	92565

MEATDORIA	→ NTK	Stock
82212	EPBBPT4-V002Z	95912
82220	EPBMPN4-A035Z	96317
82220	EPBMPT4-A017Z	96798
82221	EPBBPT4-V008Z	92801
82222	EPBMPT4-A030Z	96501
82223	EPBMPN3-A045Z	93151
82224	EPBBPT4-V013Z	91803
82225	EPBMPN3-A004Z	90833
82225	EPBBPN3-A002Z	94523
82226	EPBMPT4-V022Z	90125
82227	EPBMPT4-V037Z	92354
82228	EPBMPT4-V009Z	96309
82229	EPBBPT4-V021Z	97219
82230	EPBMPT4-V026Z	91770
82231	EPBMPN3-V001Z	90037
82231	EPBBPN3-V007Z	97073
82244	EPBBPN3-V014Z	96895
82245	EPBBPN3-A006Z	91736
82246	EPBBPN4-V014Z	93428
82247	EPBBPT4-V009Z	95675
82248	EPBMPN3-V008Z	90549
82251	EPBBPN3-A032Z	96503
82252	EPBBPN4-V004Z	93057
82254	EPBBPT4-V010Z	91257
82281	EPBMPN3-V021Z	92226
82282	EPBMPN3-V018Z	97066
82283	EPBMPN3-V011Z	94242
82285	EPBMPN3-R012Z	96590
82286	EPBMPN3-V022Z	91412
82287	EPBMPN3-A016Z	96896
82290	EPBBPT4-A011Z	94601
82291	EPBMPT4-V039Z	96769
82292	EPBMPN3-V042Z	92659
82293	EPBMPT4-V033Z	90173
82294	EPBMPT4-A020Z	97897
82295	EPBBPN3-A018Z	95753
82296	EPBMPT4-V043Z	97765
82297	EPBBPT4-V012Z	96542
82298	EPBMPN4-A034Z	95507
82299	EPBMPN3-A015Z	94611
82300	EPBMPT4-A006Z	96115
82304	EPBBPN3-V021Z	95679
82306	EPBBPN3-V010Z	95936
82307	EPBBPT4-V005Z	93700
82308	EPBBPT4-V001Z	92565
82309	EPBBPN3-A024Z	91449
82310	EPBBPN3-A011Z	91149
82311	EPBMBN3-A003Z	90717
82312	EPBMPN3-V010Z	93991
82312	EPBMPN3-V026Z	94423
82313	EPBMPN3-V017Z	91253
82319	EPBBPN3-V016Z	92713

MEATDORIA	→ NTK	Stock
82320	EPBBPT4-A016Z	95268
82325	EPBMPN4-A035Z	96317
82326	EPBMPN3-V011Z	94242
82329	EPBMPT4-V044Z	96079
82331	EPBBPN3-V029Z	92983
82332	EPBMPT4-V016Z	92071
82333	EPBMBN3-V001Z	92099
82333	EPBMPN3-A052Z	93614
82338	EPBMBT4-A002Z	92144
82341	EPBMPN3-V019Z	93061
82344	EPBMPN3-V030Z	92953
82345	EPBBPT4-V007Z	94941
82346	EPBBPN3-A017Z	95311
82347	EPBBPN3-V019Z	95201
82348	EPBMPT4-V014Z	97115
82349	EPBBPN3-V023Z	90603
82350	EPBMBN3-V002Z	94886
82352	EPBMBT4-V004Z	96629
82359	EPBMPT4-A024Z	91744
82360	EPBMPT4-V018Z	95148
82361	EPBMPT4-V018Z	95148
82366	EPBMPN3-V041Z	92257
82367	EPBBPT4-V006Z	96941
82390	EPBMPT4-V029Z	90509
82394	EPBMPN4-A023Z	91984
82395	EPBMPT4-V021Z	97498
82396	EPBMPT4-V027Z	93059
82503	EPBBPN3-V030Z	94092
82504	EPBMPN3-A044Z	93056
82508	EPBBPT4-V019Z	95582
82516	EPBBPT4-V018Z	91887
82517	EPBBPN3-A022Z	92949
82517	EPBBPN3-A028Z	93277
82518	EPBMPT4-V038Z	94727
82521	EPBMPT4-V010Z	96347
82526	EPBBPN4-A020Z	92413
82535	EPBMPN3-V032Z	94413
82538	EPBBPN3-A028Z	93277
82540	EPBMPT4-V028Z	93902
82553	EPBMPN3-V024Z	93159
82554	EPBMBN3-V004Z	90962
82555	EPBMBN3-V005Z	90946
82556	EPBMPN3-V025Z	94855
82560	EPBMPN3-V031Z	92481
82561	EPBMBT4-A003Z	93024
82563	EPBMPT4-V031Z	94763
82564	EPBMBN3-V006Z	94835
82589	EPBMPT4-D042Z	91710
82590	EPBBPT4-V024Z	92064
82595	EPBBPN3-A031Z	95922
823005	EPBMPT4-V045Z	91802
823028	EPBBPT4-A017Z	92559



MEATDORIA	→ NTK	Stock
82118E	EPBMPN3-A007Z	96754
82120E	EPBMPT4-V003Z	93266
82121E	EPBMBT4-D001Z	91628
82123E	EPBMBN3-V001Z	92099
82135A1	EPBMPN3-A020Z	96725
82135E	EPBMPN3-A020Z	96725
82143/1	EPBBPT4-V001Z	92565
82143E	EPBBPT4-V001Z	92565
82144E	EPBMPN3-V001Z	90037
82144E	EPBMPT4-V029Z	90509
82145E	EPBMPT4-A001Z	93136
82147/1	EPBMPT4-A036Z	97175
82154/1	EPBMPN3-A004Z	90833
82154E	EPBMPN3-A004Z	90833
82159E	EPBMBT4-D001Z	91628
82159E	EPBBPT4-V003Z	91742
82162E	EPBBPN3-A001Z	94263
82164E	EPBMPT4-V002Z	94153
82199E	EPBBPT4-V015Z	94877
82212/1	EPBBPT4-V002Z	95912
82225E	EPBMPN3-A004Z	90833
82225E	EPBBPN3-A002Z	94523
82231E	EPBMPN3-V001Z	90037
82231E	EPBBPN3-V007Z	97073
82244E	EPBBPN3-V014Z	96895
82248E	EPBMPN3-V008Z	90549
82252E	EPBBPN4-V004Z	93057
82254E	EPBBPT4-V010Z	91257
82283E	EPBMPN3-V011Z	94242
82286E	EPBMPN3-V022Z	91412
82290E	EPBBPT4-A011Z	94601
82295E	EPBBPN3-A018Z	95753
823005E	EPBMPT4-V045Z	91802
82300E	EPBMPT4-A006Z	96115
82301E	EPBBPT4-V002Z	95912
82304E	EPBBPN3-V021Z	95679
82307/1	EPBBPT4-V005Z	93700
82307E	EPBBPT4-V005Z	93700
82308E	EPBBPT4-V001Z	92565
82309E	EPBBPN3-A024Z	91449
82310E	EPBBPN3-A011Z	91149
82311E	EPBMBN3-A003Z	90717
82312E	EPBMPN3-V010Z	93991
82312E	EPBMPN3-V026Z	94423
82313E	EPBMPN3-V017Z	91253
82319E	EPBBPN3-V016Z	92713
82331E	EPBBPN3-V029Z	92983
82341A1	EPBMPN3-V019Z	93061
82352E	EPBMBT4-V004Z	96629
82503E	EPBBPN3-V030Z	94092
82508E	EPBBPT4-V019Z	95582
82526E	EPBBPN4-A020Z	92413

MEATDORIA	→ NTK	Stock
82585A1	EPBBPT4-V024Z	92064
METZGER	→ NTK	Stock
0906081	EPBBPN3-A004Z	97711
0906175	EPBMPN3-A052Z	93614
906175	EPBMPN3-A052Z	93614
906236	EPBMPN3-A050Z	96018
906237	EPBMPN3-A049Z	93927
906238	EPBMPN3-A048Z	94778
906239	EPBMPT4-A046Z	92256
PIERBURG	→ NTK	Stock
7.18222.01.0	EPBMPN3-A003Z	92477
7.18222.02.0	EPBMPN3-A007Z	96754
7.18222.03.0	EPBMPT4-V003Z	93266
7.18222.04.0	EPBMBN3-V001Z	92099
7.18222.05.0	EPBMPN3-A020Z	96725
7.18222.06.0	EPBBPN3-A015Z	96911
7.18222.07.0	EPBMPN3-A040Z	94558
7.18222.08.0	EPBBPN3-V034Z	96381
7.18222.09.0	EPBMPT4-V008Z	96201
7.18222.10.0	EPBMPN3-A027Z	90915
7.18222.11.0	EPBMPT4-A036Z	97175
7.18222.12.0	EPBBPT4-V010Z	91257
7.18222.13.0	EPBMPN4-V040Z	95972
7.18222.14.0	EPBBPN3-A012Z	91308
7.18222.15.0	EPBMPN4-V041Z	94063
7.18222.16.0	EPBMPN3-A028Z	93480
7.18222.17.0	EPBMPN3-A034Z	92094
7.18222.18.0	EPBBPT4-V015Z	94877
7.18222.19.0	EPBMPN3-A009Z	92952
7.18222.20.0	EPBMPT4-D005Z	93653
7.18222.21.0	EPBMPT4-A001Z	93136
7.18222.22.0	EPBMPN3-A002Z	96249
7.18222.25.0	EPBMPN3-V001Z	90037
7.18222.25.0	EPBMPN3-V005Z	93871
7.18222.26.0	EPBBPT4-V002Z	95912
7.18222.27.0	EPBBPT4-V001Z	92565
Sidat	→ NTK	Stock
81.040	EPBMPT4-V029Z	90509
81.164	EPBBPN3-V010Z	95936
84.201	EPBMPN3-A002Z	96249
84.202	EPBMPN3-A003Z	92477
84.203	EPBMPN3-D029Z	95772
84.205	EPBMPT4-D025Z	92358
84.206	EPBMPN3-A009Z	92952
84.207	EPBMPT4-V004Z	92899
84.208	EPBMPN3-V001Z	90037
84.208	EPBMPN3-V005Z	93871
84.209	EPBMPN3-A007Z	96754
84.210	EPBMPT4-V012Z	91940
84.211	EPBMPT4-V003Z	93266
84.212	EPBMBT4-D001Z	91628
84.213	EPBMBN3-V001Z	92099

Sidat	→ NTK	Stock
84.215	EPBBPN3-V034Z	96381
84.216	EPBMPT4-V032Z	96108
84.217	EPBMPN3-A043Z	92940
84.218	EPBMPN3-A027Z	90915
84.219	EPBMPN3-A020Z	96725
84.220	EPBBPT4-V001Z	92565
84.221	EPBMPN3-V001Z	90037
84.221	EPBMPT4-V029Z	90509
84.222	EPBMPT4-A001Z	93136
84.223	EPBMPT4-A007Z	96755
84.224	EPBMPT4-A036Z	97175
84.225	EPBBPT4-V010Z	91257
84.226	EPBMPT4-D005Z	93653
84.227	EPBMPT4-V011Z	91119
84.228	EPBMPT4-V008Z	96201
84.229	EPBMPN4-V040Z	95972
84.230	EPBMPN4-V013Z	93089
84.231	EPBMPN3-A004Z	90833
84.232	EPBBPN3-A009Z	96930
84.233	EPBMPN3-V006Z	97501
84.234	EPBBPN3-A013Z	95023
84.235	EPBMBT4-D001Z	91628
84.235	EPBBPT4-V003Z	91742
84.236	EPBMPN3-A035Z	92810
84.237	EPBBPN3-A003Z	91268
84.237	EPBBPN3-A006Z	91736
84.238	EPBBPN3-A001Z	94263
84.239	EPBBPN3-V008Z	90842
84.239	EPBMPN3-V013Z	94788
84.240	EPBMPT4-V002Z	94153
84.241	EPBMPT4-V015Z	95488
84.242	EPBBPN3-A012Z	91308
84.243	EPBBPN3-A020Z	91829
84.244	EPBBPN3-A004Z	97711
84.245	EPBBPN3-A005Z	90934
84.246	EPBMPN4-V041Z	94063
84.247	EPBMPN3-V013Z	94788
84.248	EPBMPN3-A028Z	93480
84.249	EPBBPN3-A027Z	92471
84.250	EPBBPN3-A015Z	96911
84.251	EPBMPN3-A034Z	92094
84.252	EPBMPN3-A040Z	94558
84.253	EPBBPT4-V015Z	94877
84.254	EPBBPN3-A031Z	95922
84.255	EPBBPN3-A025Z	97101
84.256	EPBBPT4-V001Z	92565
84.257	EPBBPT4-V002Z	95912
84.258	EPBMPN4-A035Z	96317
84.258	EPBMPT4-A017Z	96798
84.259	EPBBPT4-V008Z	92801
84.260	EPBMPT4-A030Z	96501
84.261	EPBMPN3-A045Z	93151

Sidat	→ NTK	Stock
84.262	EPBBPT4-V013Z	91803
84.263	EPBMPN3-A004Z	90833
84.263	EPBBPN3-A002Z	94523
84.264	EPBMPT4-V022Z	90125
84.265	EPBMPT4-V037Z	92354
84.266	EPBMPT4-V009Z	96309
84.267	EPBBPT4-V021Z	97219
84.268	EPBMPT4-V026Z	91770
84.269	EPBMPN3-V001Z	90037
84.269	EPBBPN3-V007Z	97073
84.270	EPBBPN3-V014Z	96895
84.271	EPBBPN3-A006Z	91736
84.272	EPBBPN4-V014Z	93428
84.273	EPBBPT4-V009Z	95675
84.274	EPBMPN3-V008Z	90549
84.277	EPBBPN3-A032Z	96503
84.278	EPBBPN4-V004Z	93057
84.279	EPBBPT4-V010Z	91257
84.284	EPBMPN3-V021Z	92226
84.285	EPBMPN3-V018Z	97066
84.286	EPBMPN3-V011Z	94242
84.287	EPBMPN3-R012Z	96590
84.288	EPBMPN3-V022Z	91412
84.289	EPBMPN3-A016Z	96896
84.290	EPBBPT4-A011Z	94601
84.291	EPBMPT4-V039Z	96769
84.292	EPBMPN3-V042Z	92659
84.293	EPBMPT4-V033Z	90173
84.294	EPBMPT4-A020Z	97897
84.295	EPBBPN3-A018Z	95753
84.296	EPBMPT4-V043Z	97765
84.297	EPBBPT4-V012Z	96542
84.298	EPBMPN4-A034Z	95507
84.299	EPBMPN3-A015Z	94611
84.300	EPBMPT4-A006Z	96115
84.301	EPBBPT4-V002Z	95912
84.304	EPBBPN3-V021Z	95679
84.305	EPBBPN3-V010Z	95936
84.307	EPBBPT4-V005Z	93700
84.308	EPBBPT4-V001Z	92565
84.309	EPBBPN3-A024Z	91449
84.310	EPBBPN3-A011Z	91149
84.311	EPBMBN3-A003Z	90717
84.312	EPBMPN3-V010Z	93991
84.312	EPBMPN3-V026Z	94423
84.313	EPBMPN3-V017Z	91253
84.320	EPBBPN3-V016Z	92713
84.321	EPBBPT4-A016Z	95268
84.326	EPBMPT4-V044Z	96079
84.327	EPBMPN4-A035Z	96317
84.328	EPBMPN3-V011Z	94242
84.332	EPBBPN3-V029Z	92983





Industry

Sidat	→ NTK	Stock
84.333	EPBMPT4-V016Z	92071
84.334	EPBMBN3-V001Z	92099
84.334	EPBMPN3-A052Z	93614
84334	EPBMPN3-A052Z	93614
84.339	EPBMBT4-A002Z	92144
84.342	EPBMPN3-V019Z	93061
84.346	EPBMPN3-V030Z	92953
84.347	EPBBPT4-V007Z	94941
84.348	EPBBPN3-A017Z	95311
84.349	EPBBPN3-V019Z	95201
84.350	EPBMPT4-V014Z	97115
84.351	EPBBPN3-V023Z	90603
84.352	EPBMBN3-V002Z	94886
84.354	EPBMBT4-V004Z	96629
84.360	EPBMPT4-A024Z	91744
84.361	EPBMPT4-V018Z	95148
84.362	EPBMPT4-V018Z	95148
84.368	EPBMPN3-V041Z	92257
84.369	EPBBPT4-V006Z	96941
84.392	EPBMPT4-V029Z	90509
84.396	EPBMPN4-A023Z	91984
84.397	EPBMPT4-V021Z	97498
84.398	EPBMPT4-V027Z	93059
84.441	EPBBPN3-V030Z	94092
84.442	EPBMPN3-A044Z	93056
84.446	EPBBPT4-V019Z	95582
84.451	EPBBPT4-V018Z	91887
84.452	EPBBPN3-A022Z	92949
84.452	EPBBPN3-A028Z	93277
84.453	EPBMPT4-V038Z	94727
84.456	EPBMPT4-V010Z	96347
84.461	EPBBPN4-A020Z	92413
84.470	EPBMPN3-V032Z	94413
84.473	EPBBPN3-A028Z	93277
84.475	EPBMPT4-V028Z	93902
84.488	EPBMPN3-V024Z	93159
84.489	EPBMBN3-V004Z	90962
84.490	EPBMBN3-V005Z	90946
84.491	EPBMPN3-V025Z	94855
84.495	EPBMPN3-V031Z	92481
84.496	EPBMBT4-A003Z	93024
84.498	EPBMPT4-V031Z	94763
84.499	EPBMBN3-V006Z	94835
84.3026	EPBMPT4-D042Z	91710
84.3027	EPBBPT4-V024Z	92064
84.3032	EPBBPN3-A031Z	95922
84.3064	EPBMPT4-V045Z	91802
551172A	EPBBPT4-V001Z	92565
84.209A2	EPBMPN3-A007Z	96754
84.211A2	EPBMPT4-V003Z	93266
84.212A2	EPBMBT4-D001Z	91628
84.213A2	EPBMBN3-V001Z	92099

Sidat	→ NTK	Stock
84.219A2	EPBMPN3-A020Z	96725
84.220A2	EPBBPT4-V001Z	92565
84.221A2	EPBMPN3-V001Z	90037
84.221A2	EPBMPT4-V029Z	90509
84.222A2	EPBMPT4-A001Z	93136
84.224A2	EPBMPT4-A036Z	97175
84.228A2	EPBMPT4-V008Z	96201
84.231A2	EPBMPN3-A004Z	90833
84.235A2	EPBMBT4-D001Z	91628
84.235A2	EPBBPT4-V003Z	91742
84.238A2	EPBBPN3-A001Z	94263
84.240A2	EPBMPT4-V002Z	94153
84.253A2	EPBBPT4-V015Z	94877
84.255A2	EPBBPN3-A025Z	97101
84.257A2	EPBBPT4-V002Z	95912
84.263A2	EPBMPN3-A004Z	90833
84.263A2	EPBBPN3-A002Z	94523
84.269A2	EPBMPN3-V001Z	90037
84.269A2	EPBBPN3-V007Z	97073
84.270A2	EPBBPN3-V014Z	96895
84.274A2	EPBMPN3-V008Z	90549
84.278A2	EPBBPN4-V004Z	93057
84.279A2	EPBBPT4-V010Z	91257
84.286A2	EPBMPN3-V011Z	94242
84.288A2	EPBMPN3-V022Z	91412
84.290A2	EPBBPT4-A011Z	94601
84.301A2	EPBBPT4-V002Z	95912
84.3022A2	EPBBPT4-V024Z	92064
84.304A2	EPBBPN3-V021Z	95679
84.3064A2	EPBMPT4-V045Z	91802
84.307A2	EPBBPT4-V005Z	93700
84.308A2	EPBBPT4-V001Z	92565
84.309A2	EPBBPN3-A024Z	91449
84.310A2	EPBBPN3-A011Z	91149
84.311A2	EPBMBN3-A003Z	90717
84.312A2	EPBMPN3-V010Z	93991
84.312A2	EPBMPN3-V026Z	94423
84.313A2	EPBMPN3-V017Z	91253
84.320A2	EPBBPN3-V016Z	92713
84.332A2	EPBBPN3-V029Z	92983
84.342A2	EPBMPN3-V019Z	93061
84.354A2	EPBMBT4-V004Z	96629
84.441A2	EPBBPN3-V030Z	94092
84.446A2	EPBBPT4-V019Z	95582
84.461A2	EPBBPN4-A020Z	92413
SIEMENS	→ NTK	Stock
5 WK 9680	EPBMPT4-A007Z	96755
5 WK 96819	EPBMPT4-V016Z	92071
5 WK 9693 Z	EPBMPT4-V004Z	92899
5 WK 9698	EPBMPT4-V021Z	97498
5 WK 9699	EPBMPT4-V027Z	93059



TRISCAN	→ NTK	Stock
8824 10033	EPBMPN3-A047Z	90252
8824 14005	EPBMPN3-A050Z	96018
Vemo	→ NTK	Stock
V10-72-0918	EPBMPT4-D005Z	93653
V10-72-0918-1	EPBMPT4-D005Z	93653
V10-72-0981	EPBMPN3-A027Z	90915
V10-72-1026	EPBMPT4-D025Z	92358
V10-72-1026-1	EPBMPT4-D025Z	92358
V10-72-1028	EPBMPT4-V011Z	91119
V10-72-1028	EPBMPT4-V004Z	92899
V10-72-1028-1	EPBMPT4-V011Z	91119
V10-72-1028-1	EPBMPT4-V004Z	92899
V10-72-1039	EPBBPT4-V003Z	91742
V10-72-1044	EPBMBT4-D001Z	91628
V10-72-1107	EPBBPT4-V002Z	95912
V10-72-1130	EPBBPN4-V014Z	93428
V10-72-1130-1	EPBBPN4-V014Z	93428
V10-72-1131	EPBMPN4-V013Z	93089
V10-72-1132	EPBMPT4-V008Z	96201
V10-72-1134	EPBMPT4-V008Z	96201
V10-72-1137	EPBMPN4-V040Z	95972
V10-72-1138	EPBMPN4-V041Z	94063
V10-72-1138-1	EPBMPN4-V041Z	94063
V10-72-1139	EPBBPT4-V015Z	94877
V10-72-1200	EPBMPT4-V022Z	90125
V10-72-1523	EPBBPT4-V019Z	95582
V20-72-0057	EPBBPN3-A004Z	97711
V20-72-0057-1	EPBBPN3-A004Z	97711
V20-72-0058	EPBBPN3-A005Z	90934
V20-72-0090	EPBBPT4-V006Z	96941
V20-72-0093	EPBMBN3-V002Z	94886
V20-72-0135	EPBBPN3-V030Z	94092
V20-72-0526	EPBBPT4-V008Z	92801
V20-72-5129	EPBMPT4-A006Z	96115
V20-72-5133	EPBMPT4-V009Z	96309
V20-72-5209	EPBBPT4-A016Z	95268
V20-72-5210	EPBBPN3-A024Z	91449
V20-72-5275	EPBMPN3-A044Z	93056
V22-72-0037	EPBMPN3-A002Z	96249
V22-72-0047	EPBBPN3-A003Z	91268
V22-72-0060	EPBMPN3-A009Z	92952
V22-72-0061	EPBMPT4-A001Z	93136
V22-72-0075	EPBBPN3-A027Z	92471
V22-72-0076	EPBBPN3-A001Z	94263
V22-72-0077	EPBBPN3-A006Z	91736
V22-72-0157	EPBBPN3-A017Z	95311
V24-72-0025	EPBMPN3-A043Z	92940
V24-72-0036	EPBMPT4-V012Z	91940
V24-72-0075	EPBMPT4-V003Z	93266
V24-72-0076	EPBBPN3-V034Z	96381
V24-72-0099	EPBBPT4-V001Z	92565
V24-72-0100	EPBMPN3-V022Z	91412

Vemo	→ NTK	Stock
V24-72-0100-1	EPBMPN3-V022Z	91412
V24-72-0101	EPBBPT4-V010Z	91257
V24-72-0169	EPBBPT4-V012Z	96542
V24-72-0211	EPBMPT4-V028Z	93902
V25-72-0061	EPBMPT4-A017Z	96798
V25-72-0062	EPBMPT4-V002Z	94153
V25-72-0063	EPBMPT4-V015Z	95488
V25-72-0064	EPBMPT4-A036Z	97175
V25-72-0064-1	EPBMPT4-A036Z	97175
V25-72-0065	EPBMPT4-A007Z	96755
V25-72-0072	EPBBPN3-A032Z	96503
V25-72-0073	EPBBPN3-A026Z	96088
V25-72-0074	EPBMPN3-V008Z	90549
V25-72-0075	EPBMPN3-D029Z	95772
V25-72-0076	EPBBPN3-A022Z	92949
V25-72-0076	EPBBPN3-A028Z	93277
V25-72-0076	EPBBPN3-A015Z	96911
V25-72-0079	EPBBPT4-V013Z	91803
V25-72-0080	EPBMPT4-V037Z	92354
V25-72-0091	EPBBPN3-V021Z	95679
V25-72-0092	EPBMPN4-A035Z	96317
V25-72-0178	EPBBPT4-A011Z	94601
V25-72-0183	EPBMPT4-A020Z	97897
V25-72-1034	EPBBPN3-A031Z	95922
V25-72-1061	EPBBPN3-A033Z	96394
V25-72-1094	EPBBPN3-A018Z	95753
V25-72-1095	EPBMPN3-V019Z	93061
V25-72-1169	EPBMBT4-A003Z	93024
V26-72-0003	EPBMPN3-A015Z	94611
V26-72-0006	EPBMPT4-V038Z	94727
V26-72-0007	EPBMPN3-R046Z	95625
V26-72-0008	EPBMPN3-R012Z	96590
V26-72-0062	EPBBPN3-V010Z	95936
V27-72-0002	EPBBPT4-V005Z	93700
V30-72-0150	EPBBPN3-A002Z	94523
V30-72-0152	EPBBPN3-A009Z	96930
V30-72-0152-1	EPBBPN3-A009Z	96930
V30-72-0153	EPBMPN3-A004Z	90833
V30-72-0181	EPBBPN3-A011Z	91149
V30-72-0235	EPBMPT4-V021Z	97498
V30-72-0711	EPBMPT4-V010Z	96347
V30-72-0713	EPBMBN3-A003Z	90717
V32-72-0089	EPBMPN3-V024Z	93159
V32-72-0090	EPBMPN3-V032Z	94413
V32-72-0099	EPBMPN3-A016Z	96896
V38-72-0199	EPBMPT4-V016Z	92071
V40-72-0287	EPBMPN3-V041Z	92257
V40-72-0323	EPBMPN3-A003Z	92477
V40-72-0380	EPBBPN3-A015Z	96911
V40-72-0381	EPBMPN3-V006Z	97501
V40-72-0382	EPBBPN3-A013Z	95023
V40-72-0382-1	EPBBPN3-A013Z	95023



Vemo	→ NTK	Stock
V40-72-0383	EPBMPN3-A028Z	93480
V40-72-0398	EPBMPN3-V001Z	90037
V40-72-0398	EPBMPN3-V005Z	93871
V40-72-0416	EPBMBN3-V001Z	92099
V40-72-0416-1	EPBMBN3-V001Z	92099
V40-72-0421	EPBBPN3-A012Z	91308
V40-72-0448	EPBMPN3-A036Z	95612
V40-72-0485	EPBMBT4-A002Z	92144
V40-72-0569	EPBBPN3-V029Z	92983
V40-72-0570	EPBMPN3-V018Z	97066
V40-72-0572	EPBMPN3-V010Z	93991
V40-72-0572	EPBMPN3-V026Z	94423
V40-72-0573	EPBMPN3-V017Z	91253
V40-72-0664	EPBMBT4-V004Z	96629
V42-72-0017	EPBMPN3-A007Z	96754
V42-72-0018	EPBMPN3-A020Z	96725
V42-72-0036	EPBMPN3-A035Z	92810
V46-72-0021	EPBMPN3-V001Z	90037
V46-72-0023	EPBBPN3-V014Z	96895
V46-72-0025	EPBMPN3-V013Z	94788
V46-72-0026	EPBBPN3-V008Z	90842
V46-72-0026	EPBMPN3-V013Z	94788
V46-72-0081	EPBBPN4-V004Z	93057
V46-72-0097	EPBBPN3-V007Z	97073
V46-72-0123	EPBBPN3-V019Z	95201
V46-72-0123-1	EPBBPN3-V019Z	95201
V46-72-0124	EPBBPN3-V016Z	92713
V46-72-0146	EPBMPT4-V029Z	90509
V50-72-0017	EPBBPN3-A025Z	97101
V50-72-0023	EPBMPN3-A034Z	92094
V50-72-0026	EPBBPT4-V021Z	97219
V50-72-0027	EPBMPT4-V026Z	91770
V51-72-0030	EPBMPN3-V011Z	94242
V51-72-0031	EPBMPN3-V021Z	92226
V51-72-0032	EPBMPN3-V042Z	92659
V52-72-0119	EPBMPT4-V039Z	96769
V52-72-0135	EPBBPT4-V007Z	94941
V52-72-0135-1	EPBBPT4-V007Z	94941
V52-72-0136	EPBMPT4-V014Z	97115
V52-72-0151	EPBMPT4-V018Z	95148
V52-72-0151-1	EPBMPT4-V018Z	95148
V52-72-0164	EPBMPN3-V030Z	92953
V52-72-0165	EPBBPN3-V023Z	90603
V52-72-0198	EPBMBN3-V006Z	94835
V53-72-0057	EPBMPT4-V033Z	90173
V63-72-0005	EPBMPN3-V025Z	94855
V64-72-0035	EPBMPN3-V031Z	92481
V70-72-0017	EPBMPT4-A030Z	96501
V70-72-0141	EPBMBN3-V004Z	90962
V70-72-0142	EPBMBN3-V005Z	90946
V70-72-0143	EPBMPN4-A023Z	91984
V95-72-0030	EPBMPN3-A040Z	94558

Vemo	→ NTK	Stock
V95-72-0041	EPBMPN3-A033Z	96422
V95-72-0042	EPBMPN3-A023Z	96241
V95-72-0043	EPBMPN3-A037Z	94170
V95-72-0044	EPBMPN3-A014Z	90281
V95-72-0045	EPBMPN3-A045Z	93151
V95-72-0046	EPBBPT4-V009Z	95675
V95-72-0046-1	EPBBPT4-V009Z	95675
V95-72-0108	EPBBPN4-A020Z	92413
V95-72-0119	EPBBPT4-V018Z	91887

DISCONTINUED PRODUCTS









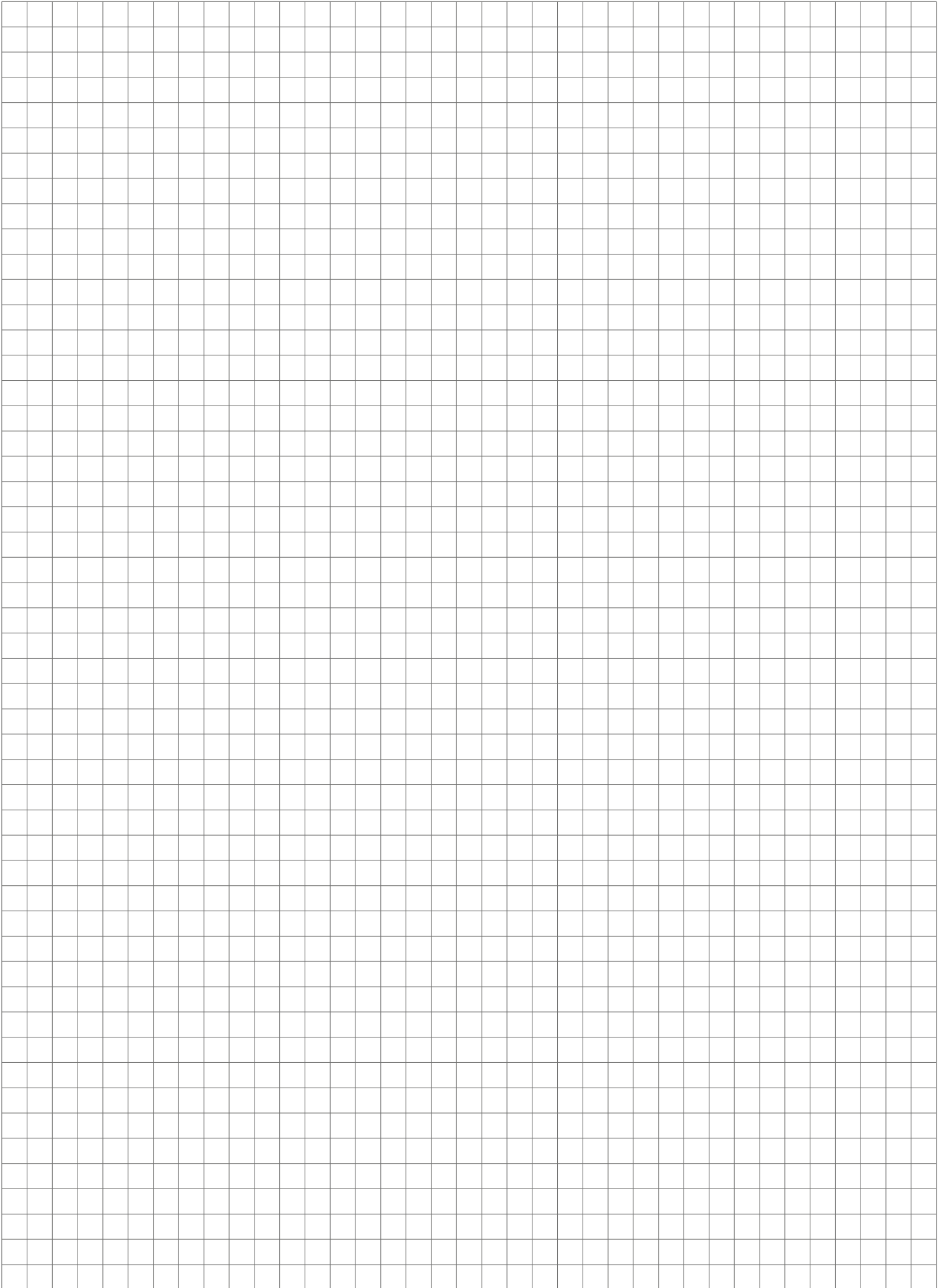











VEHICLE
ELECTRONICS























Old Order-No.	Old Part-No.	New Order-No.	New Part-No.
90386	EPBBPT4-V022Z	/	/
91802	EPBMPT4-V045Z	/	/























Legend

	GB	DE	FR	IT	ES
	2 Sensors installed	2 Sensoren verbaut	2 Capteurs installés	2 Sensori installati	2 Sensores instalados
	For vehicles with ABS	Für Fahrzeuge mit ABS	Pour véhicules avec système antibloccage	Per veicoli con ABS	Para vehículos con ABS
	Manual Transmission	Schaltgetriebe	Boîte de vitesses manuelle	Cambio manuale	Caja de cambios manual
	Automatic Transmission	Automatikgetriebe	Boîte automatique	Trasmissione automatica	Transmisión automática
	Country-spec. model	Länderausführung	Type de pays	Modello p. paesi	Modelo por país
	Not for country-spec. model	Nicht für Länderausführung	Pas pour version-pays	Non per versione per paese	No para modelo país
OE	For OE number	Für OE-Nummer	Pour numéro OE	Per N° OE	Para OE N°
	Front	Vorne	Avant	Anteriore	Delante
	Left	Links	Gauche	Sx	Izquierda
	Right	Rechts	Droite	Dx	Derecha
	Rear	Hinten	Arrière	Posteriore	Posterior
	Fuel Type	Kraftstoffart	Type de carburant	Tipo carburante	Tipo de combustible
	In front of the catalyst	Vor Katalysator	Devant le catalyseur	Davanti al catalizzatore	Delante del catalizador
	For left-hand drive vehicles	Für Linkslenker	Pour véhicules avec direction à gauche	Per veicolo con guida a Sx	Para vehic. dirección izquierda
	With integrated air temperature sensor	Mit integriertem Lufttemperatursensor	Avec capteur intégré de la température de l'air	Con sensore temperatura aria integrato	Con sensor incorporado temp. aire
	Without integrated air temperature sensor	Ohne integrierten Lufttemperatursensor	Sans capteur de température extérieure intégré	Senza sensore temperatura aria integrato	Sin sensor temperatura aire incorporado
	For vehicles with start-stop function	Für Fahrzeuge mit Start-Stopp-Funktion	Pour véhicules avec fonction Stop/Start	Per veicoli con funzione di start-stop	Para vehículos con sistema Start&Stop
	For vehicles without start-stop function	Für Fahrzeuge ohne Start-Stopp-Funktion	Pour véhicules sans fonction Stop/Start	Per veicoli senza funzione di start-stop	Para vehículos sin sistema Start&Stop
	For vehicles with soot filter	Für Fahrzeuge mit Rußpartikelfilter	Pour véhicules avec filtre à particules	Per veicoli con filtro antiparticolato	Para vehículos con filtro de partículas
	For vehicles without soot filter	Für Fahrzeuge ohne Rußpartikelfilter	Pour véhicules sans filtre à particules	Per veicoli senza filtro antiparticolato	Para vehículos sin filtro de partículas

Legend

	NL	PT	GR	TR
	2 Sensoren geïnstalleerd	2 Sensores instalados	Περιλαμβάνει 2 αισθητήρες	2 Sensör takildi
	Voor voertuigen met ABS	Para veículos com ABS	για οχήματα με ABS	ABS'li araçlar için
	Handgeschakeld	Caixa de velocidades manual	Μηχανικό κιβώτιο ταχυτήτων	Mekanik sanziman
	Automatische versnellingsbak	Caixa de velocidades automática	Αυτόματο κιβώτιο ταχυτήτων	Otomatik sanziman
	Landuitvoering	Versão específica de país	Έκδοση χώρας	Ülke versiyonu
	Niet voor landuitvoering	Não para versão específica de país	όχι για παραλλαγή χώρας	Ülke versiyonu için geçerli değildir
	Voor OE nummer	Para número OE	για κωδικό γνήσιου ανταλλακτικού	OE numarası için
	Voor	À frente	εμπρός	önden
	Links	Esquerda	αριστερά	sol
	Rechts	À direita	δεξιά	Sag
	Achter	Traseira	πίσω	Arka
	Brandstoftype	Tipo de combustível	Είδος καυσίμου	Yakit türü
	Voor katalysator	Antes do catalisador	πριν τον καταλύτη	Katalizatörün önünde
	Voor voertuigen met stuur links	Para veículo com volante à esquerda	για αριστεροτίμονα οχήματα	Soldan direksiyonlu araçlar için
	Met ingebouwde luchttemperatuursensor	Com sensor de temperatura do ar integrado	με ενσωματωμένο αισθητήρα θερμοκρασίας αέρα	entegre hava sıcaklık sensörü ile
	Zonder ingebouwde luchttemperatuursensor	Sem sensor da temperatura do ar integrado	χωρίς ενσωματωμένο αισθητήρα θερμοκρασίας αέρα	Entegre hava ısı sensörüne sahip değil
	Voor voertuigen met start/stop	Para veículos com função "start/stop"	για οχήματα με λειτουργία Start/Stop	Start stop fonksiyonuna sahip araçlar için
	Voor voertuigen zonder start/stop	Para veículos sem função "start/stop"	για οχήματα χωρίς λειτουργία Start/Stop	Start stop fonksiyonuna sahip olmayan araçlar için
	Voor voertuigen met roetdeeltjesfilter	Para veículos com filtro de partículas de fuligem	για οχήματα με φίλτρο σωματιδίων κάπνας	Kurum filtresi olan araçlar için
	Voor voertuigen zonder roetdeeltjesfilter	Para veículos sem filtro de partículas de fuligem	για οχήματα χωρίς φίλτρο σωματιδίων κάπνας	Kurum filtresi olmayan araçlar için

Legend

	PL	CZ	HU	RU
	2 Zainstalowane czujniki	Nainstalovány 2 senzory	2 Telepített érzékelő	Установлено 2 датчика
	Dla pojazdów z ABS	Pro vozidla s ABS	ABS-sel szerelt járművekhez	Для автомобилей с ABS
	Przekładnia mechaniczna	Manuální převodovka	Kézikapcsolású váltó	Механическая коробка передач
	Automatyczna skrzynia biegów	Automatická převodovka	Automta váltó	Автоматическая коробка передач
	Wersja na kraj	Provedení pro zemi	Országkivitel	Исполнение для страны
	Nie dla wersji dla kraju	Není určeno pro terenní provedení	Ország kivitelhez nem	Исполнение не для страны
	Dla numeru OE	Pro OE číslo	OE-számhoz	Для оригинального номера
	Z przodu	Přední	Elöl	Спереди
	Z lewej	Levá	Bal	Слева
	Z prawej	Pravá	Jobb	Справа
	Z tyłu	Zadní	Hátsó	Сзади
	Rodzaj paliwa	Typ paliva	Üzemanyagfajta	Вид топлива
	Przed katalizatorem	Před katalyzátor	Katalizátor előtt	Перед катализатором
	Dla pojazdu z kierownicą z lewej strony	Pro levostranně řízená vozidla	Balkormányoshoz	Для левостороннего расположения руля
	Ze zintegrowanym czujnikiem temperatury powietrza	S integrovaným senzorem teploty vzduchu	Integrált léghőmérséklet érzékelővel	С интегрированным датчиком температуры воздуха
	Bez zintegrowanego czujnika temperatury powietrza	Bez integrovaného senzoru teploty vzduchu	Integrált levegőhőmérséklet érzékelő nélkül	Без интегрированного датчика температуры воздуха
	Dla pojazdów z funkcją Start-Stop	Pro vozidla se start-stop funkci	Start-stop funkcióval szerelt járművekhez	Для автомобилей с функцией "Старт-Стоп"
	Dla pojazdów bez funkcji Start-Stop	Pro vozidla bez start-stop funkce	Start-stop funkció nélküli járművekhez	Для автомобилей без функции старт-стоп
	Dla samochodów z filtrem cząstek sadzy	Pro vozidla s filtrem pevných částic	Koromszűrős járművekhez	Для автомобилей с фильтром копоти
	Dla samochodów bez filtra cząstek sadzy	Pro vozidla bez filtru pevných částic	Koromszűrős járművekhez nem	Для автомобилей без фильтра копоти

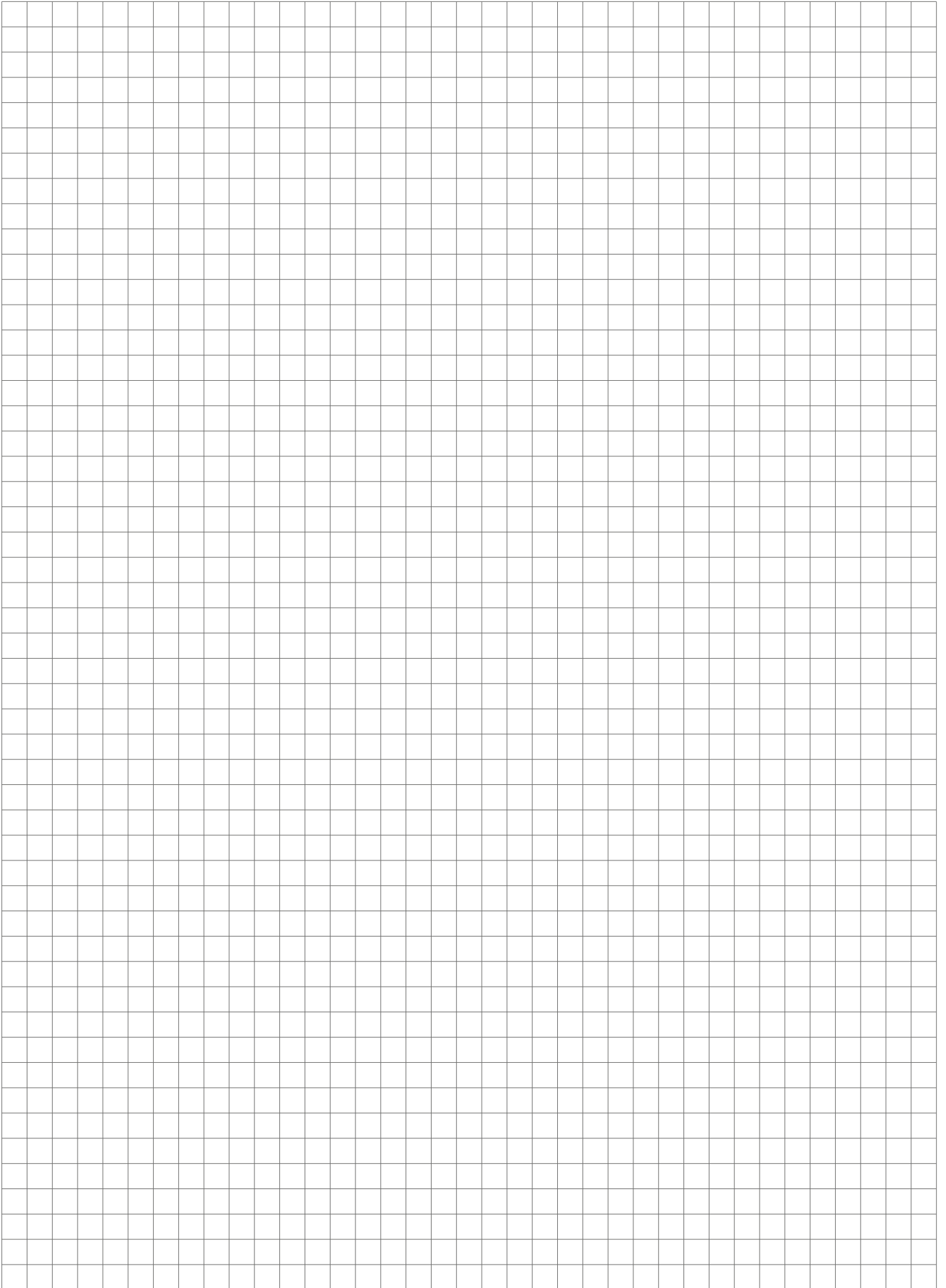

Disclaimer

EN

This catalogue supersedes all previous catalogues. NGK SPARK PLUG EUROPE GmbH has made its best effort to ensure an accurate information, based on information available at the time of the compilation of the catalogue.

This catalogue is made for information only. NGK SPARK PLUG EUROPE GmbH will not accept liability for any inaccuracy. Product linkage to vehicles or tools applications from this publication are considered under normal condition of use, fitted by a professional and for vehicles registered in Europe. For all different usage or post equipment, the responsibility of NGK SPARK PLUG EUROPE GmbH cannot be engaged. All ordered products are subject to valid terms and conditions supplied by NGK SPARK PLUG EUROPE GmbH.

The cross reference list (page 201-262, 531-574) is furnished as a guide. Due to differences in design, materials, etc., products by various manufacturers may not match. See therefore our recommendation for the proper use of the acquired product.

Pictures, diagrams and drawings in this publication are not contractual. The property of the pictures, diagrams, drawings and other graphic elements and data belong to NGK SPARK PLUG EUROPE GmbH exclusively. Reproduction of this publication, partial or total, is strictly prohibited without a prior written authorization of NGK SPARK PLUG EUROPE GmbH.

Specification is subject to change without notice.

DE

Mit Veröffentlichung dieser Ausgabe verlieren alle vorhergehenden Ausgaben ihre Gültigkeit. Dieser Katalog wurde, basierend auf den zum Zeitpunkt der Erstellung des Katalogs verfügbaren Informationen, von der NGK SPARK PLUG EUROPE GmbH nach bestmöglichem Wissen erstellt.

Dieser Katalog dient ausschließlich zu Informationszwecken. Die NGK SPARK PLUG EUROPE GmbH übernimmt keine Haftung für Druckfehler, Irrtümer oder sonstige fehlerhafte Informationen. Alle in diesem Katalog erwähnten Produkt-Zuordnungen zu Fahrzeugen oder Werkzeugen gelten für einen Einsatz unter normalen Bedingungen, den Einbau durch einen Fachmann sowie Fahrzeuge, die innerhalb der EU zugelassen sind. Die NGK SPARK PLUG EUROPE GmbH kann nicht für andere Nutzungszwecke oder Nachrüstungen jedweder Art haftbar gemacht werden. Alle bestellten Produkte unterliegen den geltenden Geschäftsbedingungen der NGK SPARK PLUG EUROPE GmbH.

Die Referenzliste (Seite 201-262, 531-574) dient nur zur Information. Bedingt durch Unterschiede hinsichtlich Konstruktion, Werkstoffen usw. können Produkte verschiedener Hersteller nicht zusammenpassen. Siehe daher unsere Empfehlung für die richtige Anwendung des erworbenen Produkts.

Die in diesem Katalog abgebildeten Bilder, Diagramme und Zeichnungen sind nicht Vertragsbestandteil. Alle

Bilder, Diagramme, Zeichnungen sowie andere graphische Elemente und Daten sind exklusives Eigentum der NGK SPARK PLUG EUROPE GmbH. Jedwede Vervielfältigung dieses Katalogs, auch auszugsweise, ohne vorherige schriftliche Genehmigung durch die NGK SPARK PLUG EUROPE GmbH ist strengstens untersagt.

Die Spezifikation kann ohne vorherige Ankündigung geändert werden.

FR

NGK SPARK PLUG EUROPE GmbH a réalisé tous les efforts nécessaires pour assurer l'exactitude des informations sur la base des informations disponibles au moment de la compilation du catalogue.

Ce catalogue a été élaboré à titre informatif uniquement. NGK SPARK PLUG EUROPE GmbH n'acceptera aucune responsabilité en cas d'inexactitude. Les liens de produits avec des véhicules ou des outils dans cette publication sont considérés dans des conditions normales d'utilisation, installés par un professionnel et pour les véhicules immatriculés en Europe. Pour toute utilisation différente ou équipement de conversion, la responsabilité de NGK SPARK PLUG EUROPE GmbH ne peut pas être engagée. Tous les produits commandés sont soumis à des termes et conditions valides fournis par NGK SPARK PLUG EUROPE GmbH. Les images, diagrammes et dessins de cette publication ne sont pas contractuels.

Ce tableau de comparaison (page 201-262, 531-574) est donné à titre indicatif. De par leurs différences de conceptions, matériaux, etc., les pièces produites par les différents fabricants n'ont pas exactement les mêmes caractéristiques. Se reporter au tableau d'affectations NGK SPARK PLUG EUROPE GmbH pour déterminer la référence adaptée à l'application.

Les images, les diagrammes, les dessins et autres éléments graphiques et données appartiennent à NGK SPARK PLUG EUROPE GmbH exclusivement. La reproduction de cette publication, partielle ou totale, est strictement interdite sans autorisation écrite préalable de NGK SPARK PLUG EUROPE GmbH.

Les spécifications peuvent être sujettes à modifications sans avis préalable.

IT

Il presente catalogo sostituisce tutti i precedenti. NGK SPARK PLUG EUROPE GmbH ha posto la massima attenzione per offrire informazioni accurate, basate sui dati disponibili al momento della compilazione del catalogo. Il presente catalogo ha esclusivamente scopo informativo. NGK SPARK PLUG EUROPE GmbH non si assume nessuna responsabilità per eventuali imprecisioni. Si considera che i veicoli a cui si riferisce questa pubblicazione si trovino in condizioni di utilizzo normali, siano stati montati da un professionista e su veicoli immatricolati in Europa. Per qualsiasi utilizzo o per attrezzature montate successivamente, NGK SPARK PLUG EUROPE GmbH non si assume nessuna responsabilità.

Tutti i prodotti ordinati sono soggetti ai termini e alle condizioni forniti da NGK SPARK PLUG EUROPE GmbH. Le tabelle comparative (pag. 201-262, 531-574) vengono fornite a scopo di guida. A causa della differenza nel design, materiale, ecc.. le candele d'accensione prodotte da un altro costruttore potrebbero non corrispondere. Attenersi alle nostre raccomandazioni per il corretto utilizzo del prodotto. Le immagini, i grafici e i disegni presenti in questa pubblicazione non sono contrattuali. Le immagini, dei grafici, i disegni e gli altri elementi e dati sono di proprietà esclusiva di NGK SPARK PLUG EUROPE GmbH. La riproduzione della presente pubblicazione, parziale o totale, è strettamente proibita senza la preventiva autorizzazione scritta di NGK SPARK PLUG EUROPE GmbH. Le specifiche sono soggette a modifiche senza preavviso.

ES

Este catálogo reemplaza a todos los catálogos anteriores. NGK SPARK PLUG EUROPE GmbH ha hecho todo lo posible para garantizar que la información sea correcta, basándose en la información disponible en el momento de la redacción del catálogo.

Este catálogo se ha hecho con propósitos meramente informativos. NGK SPARK PLUG EUROPE GmbH no acepta ninguna responsabilidad por los posibles errores. Se considera que la utilización de los productos en vehículos o aplicaciones de herramientas de esta publicación se realiza en condiciones de uso normales, montados por un profesional y en vehículos matriculados en Europa. Para todos los otros usos o equipamiento a posteriori, NGK SPARK PLUG EUROPE GmbH no puede considerarse responsable. Todos los productos pedidos están sujetos a los términos y condiciones válidos de NGK SPARK PLUG EUROPE GmbH. Las imágenes, los diagramas y los dibujos de esta publicación no tienen valor contractual.

La lista de referencias cruzadas (páginas 201-262, 531-574) le servirá como guía. Debido a la diferencia en el diseño, materiales, etc., las bobinas producidas por otro fabricante pueden no coincidir. Siga nuestras recomendaciones para el uso adecuado del producto.

Las imágenes, los diagramas, los dibujos, los otros elementos gráficos y los datos son propiedad exclusiva de NGK SPARK PLUG EUROPE GmbH. La reproducción total o parcial de esta publicación está estrictamente prohibida sin una autorización previa por escrito de NGK SPARK PLUG EUROPE GmbH.

Las especificaciones están sujetas a cambios sin previo aviso.

NL

Deze catalogus vervangt alle eerdere catalogi. NGK SPARK PLUG EUROPE GmbH heeft alles in het werk gesteld om voor nauwkeurige informatie te zorgen, op basis van de informatie die voorhanden was op het moment dat de catalogus werd samengesteld.

Deze catalogus dient slechts ter informatie. NGK SPARK PLUG EUROPE GmbH aanvaardt geen aansprakelijkheid voor eventuele onnauwkeurigheden. Producten die in verband

worden gebracht met voertuigen of gereedschaptoepassingen van deze publicatie worden beschouwd onder normale gebruiksomstandigheden, geïnstalleerd door een professional en voor voertuigen die in Europa zijn geregistreerd. Voor alle andere gebruik of retrofitting aanvaardt NGK SPARK PLUG EUROPE GmbH geen aansprakelijkheid. Alle bestelde producten vallen onder de geldige algemene voorwaarden van NGK SPARK PLUG EUROPE GmbH.

De lijst met kruisverwijzingen (pagina 201-262, 531-574) dient als leidraad. Door verschillen in ontwerp, materialen, enz. kunnen producten die door verschillende fabrikanten zijn vervaardigd afwijken. Zie ook onze aanbeveling voor het juiste gebruik van het product dat u gekocht heeft.

Afbeeldingen, schema's en tekeningen in deze publicatie zijn niet bindend. Afbeeldingen, schema's, tekeningen en andere grafische elementen en gegevens zijn exclusief eigendom van NGK SPARK PLUG EUROPE GmbH. Gedeeltelijke of volledige reproductie van deze publicatie is ten strengste verboden zonder schriftelijke toestemming vooraf van NGK SPARK PLUG EUROPE GmbH.

Specificaties kunnen zonder voorafgaande kennisgeving worden gewijzigd.

PT

Este catálogo substitui todos os catálogos anteriores. NGK SPARK PLUG EUROPE GmbH emvidou os seus melhores esforços para assegurar uma informação precisa, com base nas informações disponíveis no momento da compilação do catálogo. Este catálogo é elaborado apenas para efeitos informativos. NGK SPARK PLUG EUROPE GmbH não aceita qualquer responsabilidade por qualquer imprecisão. A ligação do produto a aplicações de veículos ou ferramentas desta publicação é considerada sob condições normais de uso, montado por um profissional e para veículos matriculados na Europa. Para todos os usos diferentes ou pós-equipamento, a responsabilidade de NGK SPARK PLUG EUROPE GmbH não pode se comprometer. Todos os produtos encomendados estão sujeitos a termos e condições válidos fornecidos pela NGK SPARK PLUG EUROPE GmbH. Esta lista de referência cruzada (página 201-262, 531-574) é fornecida como guia. Devido a diferenças em termos de design, materiais, etc., os produtos dos vários fabricantes poderão não corresponder. Consequentemente, consulte a nossa recomendação quanto à utilização adequada do produto adquirido. As fotos, diagramas e desenhos nesta publicação não são contratuais. A propriedade das fotos, diagramas, desenhos e outros elementos gráficos e dados pertencem exclusivamente a NGK SPARK PLUG EUROPE GmbH. A reprodução desta publicação, parcial ou integral, é estritamente proibida sem uma autorização prévia por escrito da NGK SPARK PLUG EUROPE GmbH.

As especificações estão sujeitas a alterações sem aviso prévio.



GR

Αυτός ο κατάλογος αντικαθιστά όλους τους προηγούμενους καταλόγους. Η NGK SPARK PLUG EUROPE GmbH έχει κάνει κάθε δυνατή προσπάθεια για να εξασφαλιστεί η ακριβής πληροφόρηση, βάσει των διαθέσιμων πληροφοριών κατά το χρόνο της κατάρτισης του καταλόγου. Αυτός ο κατάλογος έχει στόχο μόνο την πληροφόρηση. Η NGK SPARK PLUG EUROPE GmbH δεν αναλαμβάνει καμία ευθύνη για οποιαδήποτε ανακρίβεια. Η σύνδεση του προϊόντος σε οχήματα ή εφαρμογές εργαλείων του παρόντος καταλόγου θεωρείται ότι γίνονται υπό κανονικές συνθήκες χρήσης, με εγκατάσταση από επαγγελματίες και για τα οχήματα που έχουν ταξινομηθεί στην Ευρώπη. Για όλες τις άλλες περιπτώσεις διαφορετικής χρήσης ή προσθήκης εξοπλισμού, δεν φέρει ευθύνη η NGK SPARK PLUG EUROPE GmbH. Όλα τα παραγγελλθέντα προϊόντα υπόκεινται σε έγκυρους όρους και προϋποθέσεις που παρέχονται από την NGK SPARK PLUG EUROPE GmbH.

Αυτή η λίστα παραπομπών (σελ. 201-262, 531-574) παρέχεται ως οδηγός. Λόγω των διαφορών στη σχεδίαση, στα υλικά κ.λπ., τα προϊόντα από διάφορους κατασκευαστές ενδέχεται να παρουσιάζουν ασυμφωνίες. Συνεπώς, ανατρέξτε στις συστάσεις μας για την ενδεδειγμένη χρήση του προϊόντος που έχετε αποκτήσει. Εικόνες, διαγράμματα και σχέδια σε αυτήν την έκδοση δεν αποτελούν μέρος σύμβασης. Οι εικόνες, διαγράμματα, σχέδια και άλλα γραφικά στοιχεία και δεδομένα αποτελούν αποκλειστική ιδιοκτησία της NGK SPARK PLUG EUROPE GmbH. Απαγορεύεται αυστηρά η ολική ή μερική αναπαραγωγή της δημοσίευσης χωρίς την προηγούμενη γραπτή άδεια της NGK SPARK PLUG EUROPE GmbH. Η προδιαγραφή μπορεί να αλλάξει χωρίς προειδοποίηση.

TR

Bu katalog önceki tüm katalogların yerini alır. NGK SPARK PLUG EUROPE GmbH, bu katalogun hazırlanma aşamasında mevcut olan bilgilere dayanarak doğru bilgiler vermek için elinden geleni yapmıştır. Bu katalog yalnızca bilgi amaçlı hazırlanmıştır. NGK SPARK PLUG EUROPE GmbH, herhangi bir hata için sorumluluk kabul etmez. Bu yayındaki taşıt ve araç uygulamalarına atıfta bulunan ürün bağlantıları verilirken normal kullanım koşulları, bir uzmanca takılmış olması göz önünde bulundurulmuştur ve Avrupa'da tescillenmiş taşıtlar içindir. Farklı herhangi bir kullanım veya sonradan takılan ekipmanlar için NGK SPARK PLUG EUROPE GmbH sorumlu tutulamaz. Sipariş edilen tüm ürünler, NGK SPARK PLUG EUROPE GmbH tarafından sağlanan geçerli şartlara ve koşullara tabidir. Çapraz referans listesi (sayfa 201-262, 531-574) bir kılavuz olarak verilmiştir. Not: Bu tablo referans amaçlıdır. Tasarım, malzeme ve benzeri şeylerdeki farklılıklar sebebiyle, farklı üreticilerin ürünleri eşleşmeyebilir. Bu yüzden alınan ürünün uygun kullanımı ile ilgili tavsiyelerimize bakın. Bu yayındaki resimler, şemalar ve çizimler taahhüt değildir. Resimlerin, çizimlerin ve diğer grafik öğelerin mülkiyeti yalnızca NGK SPARK PLUG EUROPE GmbH'ye aittir. Bu yayının NGK SPARK PLUG EUROPE GmbH'den önceden yazılı izin

almadan kısmi veya tam olarak yeniden çoğaltılması kesinlikle yasaktır. Ürün özellikleri önceden bildirilmeksizin değiştirilebilir.

PL

Niniejszy katalog zastępuje wszystkie poprzednie katalogi. Firma NGK SPARK PLUG EUROPE GmbH dołożyła najlepszych starań, aby upewnić się, że katalog zawiera precyzyjne informacje opierające się na danych dostępnych w czasie opracowania katalogu. Niniejszy katalog ma charakter wyłącznie informacyjny. Firma NGK SPARK PLUG EUROPE GmbH nie ponosi żadnej odpowiedzialności za jakiegokolwiek nieprecyzyjne dane. Przystosowanie produktów do pojazdów lub narzędzi wymienionych w niniejszej publikacji zakłada normalne warunki stosowania, montaż przez profesjonalistów oraz pojazdy zarejestrowane w Europie. Firma NGK SPARK PLUG EUROPE GmbH nie ponosi żadnej odpowiedzialności za jakiegokolwiek przypadki innych zastosowań lub stosowanie w sprzęcie innego rodzaju. Wszystkie zamówione produkty podlegają odpowiednim warunkom i postanowieniom określonym przez firmę NGK SPARK PLUG EUROPE GmbH. Załączona lista porównawcza (strony 201-262, 531-574) powinna być traktowana jedynie jako wskazówka. Ze względu na różnice w kształcie, zastosowanych materiałach itp., produkty poszczególnych producentów mogą się różnić między sobą. Z powyższych powodów prosimy stosować się do zaleceń dotyczących użytkowania produktu. Ilustracje, schematy i rysunki zawarte w niniejszej publikacji nie mają mocy umownej. Ilustracje, schematy, rysunki i inne elementy graficzne oraz dane należą wyłącznie do firmy NGK SPARK PLUG EUROPE GmbH. Reprodukacja niniejszej publikacji w części lub w całości jest surowo zabroniona bez uzyskania wcześniejszego pisemnego upoważnienia ze strony firmy NGK SPARK PLUG EUROPE GmbH. Specyfikacja może ulec zmianie bez powiadomienia.

CZ

Tento katalog nahrazuje všechny předchozí katalogy. NGK SPARK PLUG EUROPE GmbH vyvinul co největší úsilí, aby poskytl nejpřesnější informace, založených na informacích dostupných v okamžiku sestavení katalogu. Tento katalog je jen pro informační účely. NGK SPARK PLUG EUROPE GmbH nepřebírá žádnou zodpovědnost na případné nepřesnosti. Propojení jednotlivých produktů s vozidly nebo použitím s nářadím z této publikace se počítají za normálních podmínek užívání, nastavených odborníky pro vozidla registrovaná v Evropě. NGK SPARK PLUG EUROPE GmbH se nezavazuje k odpovědnosti za jiné užití nebo pro následné vybavení. Všechny objednaných výrobků se týkají platné podmínky a dohody dodávek NGK SPARK PLUG EUROPE GmbH. Seznam křížových odkazů (strana 201-262, 531-574) je dodán jako průvodce. Vzhledem k rozdílu v designu, materiálech atd. se produkty od různých výrobců nemusejí

shodovat. Proto se podívejte na naše doporučení ohledně řádného použití zakoupeného produktu.

Obrázky, diagramy a kresby v této publikaci nejsou závazné. Vlastnictví obrázků, diagramů, kreseb a dalších grafických prvků a dat jsou výhradním majetkem NGK SPARK PLUG EUROPE GmbH. Jakákoliv reprodukce této publikace, ať části nebo v celku je přísně zakázána bez písemné autorizace NGK SPARK PLUG EUROPE GmbH.

Specifikace se může změnit bez předchozího upozornění.

HU

Ez a katalógus hatályon kívül helyez minden korábbi katalógust. NGK SPARK PLUG EUROPE GmbH mindent megtett annak érdekében, hogy a katalógus összeállításakor rendelkezésre álló információkon alapuló pontos tájékoztatást biztosítson.

Ez a katalógus csak tájékoztató jellegű. NGK SPARK PLUG EUROPE GmbH nem vállal felelősséget az esetleges pontatlanságokért. A jelen katalógusban szereplő járműhöz kapcsolódó elemek, vagy alkalmazási eszközök használata szokásos alkalmazási feltételek mellett értendő, és azokat szakembernek kell az Európában bejegyzett járművekbe szerelnie. Minden ettől eltérő használatért, vagy utólagos beszerelésért az NGK SPARK PLUG EUROPE GmbH semmiféle felelősséget nem vállal. Valamennyi megrendelt termékre az NGK SPARK PLUG EUROPE GmbH által meghatározott feltételek vonatkoznak. A kiadványban szereplő ábrák, diagramok és rajzok nem szerződéses jellegűek. A kereszthivatkozás lista (201-262, 531-574 oldal) csak útmutatóként szolgál. A különböző gyártók által gyártott termékek tervezésében, az anyagaiban, stb. eltérések lehetnek. Ezért vegye figyelembe ajánlásainkat a megvásárolt termék a helyes használatához.

A kiadványban szereplő ábrák, diagramok, rajzok és egyéb grafikus elemek és adatok kizárólag az NGK SPARK PLUG EUROPE GmbH tulajdonát képezik. A kiadvány részleges vagy teljes reprodukciója kizárólag az NGK SPARK PLUG EUROPE GmbH előzetes és írásos engedélyezésével történhet.

A specifikáció előzetes értesítés nélkül megváltozhat.

RU

Данный каталог заменяет все ранее изданные каталоги. Компания NGK SPARK PLUG EUROPE GmbH предприняла все возможные усилия, чтобы обеспечить точность данных, подготовленных на основе доступной на момент составления каталога информации.

Данный каталог предназначен только для информационных целей. NGK SPARK PLUG EUROPE GmbH не несет ответственность за какие-либо неточности. Примеры установки продуктов в транспортные средства или использования инструментов в данном издании рассматриваются для случаев нормального режима эксплуатации, профессионального монтажа и транспортных средств, зарегистрированных в Европе. При любых других условиях ответственность за последствия использования оборудования NGK SPARK

PLUG EUROPE GmbH не несет. На все заказанные продукты распространяются действующие условия и положения NGK SPARK PLUG EUROPE GmbH. других производителей (стр. 201-262, 531-574) предоставлен в качестве справочного материала. Продукты разных производителей могут не соответствовать друг другу вследствие отличий в конструкции, материалах и т. п. Просим вас руководствоваться нашими рекомендациями по надлежащему использованию приобретенного продукта. Изображения, графики и рисунки в данном издании не являются договорными. Права на изображения, графики, рисунки и прочие графические элементы и данные принадлежат исключительно NGK Spark Plug Europe GmbH. Воспроизведение данного издания, частично или полностью, строго запрещается без предварительного письменного разрешения NGK Spark Plug Europe GmbH. Спецификация может быть изменена без предварительного уведомления.



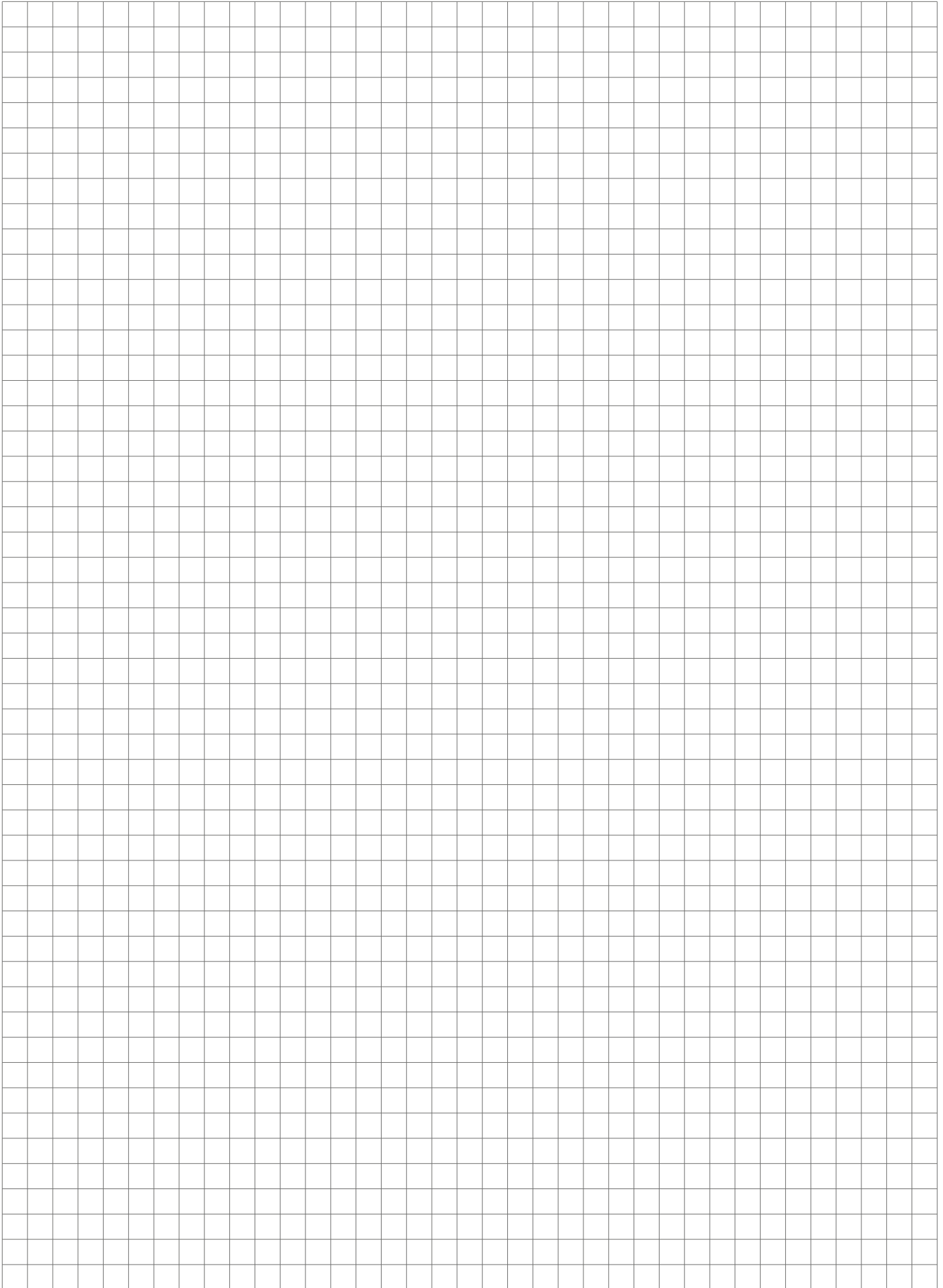

PRODUCT PORTFOLIO



IGNITION PARTS



VEHICLE ELECTRONICS

NGK SPARK PLUG offers a comprehensive range of products for the Aftermarket. Eight business areas (4-wheel, 2-wheel, industry, marine, gardening, agriculture, snowmobile and ATV/SSV) are supplied with more than 60,000 applications covering eight product lines.

With its two strong brands NGK and NTK and countless products to choose from, NGK SPARK PLUG is the world's largest supplier of spark plugs and oxygen sensors. While NGK Ignition Parts stands for the ultimate in performance – from spark plugs and glow plugs to ignition coils and ignition leads –, NTK Vehicle Electronics, the precision brand, offers vehicle electronics and great business opportunities.

All we do, innovate and produce, perfectly reflects our ultimate aim: Performance through Precision, Precision for Performance.

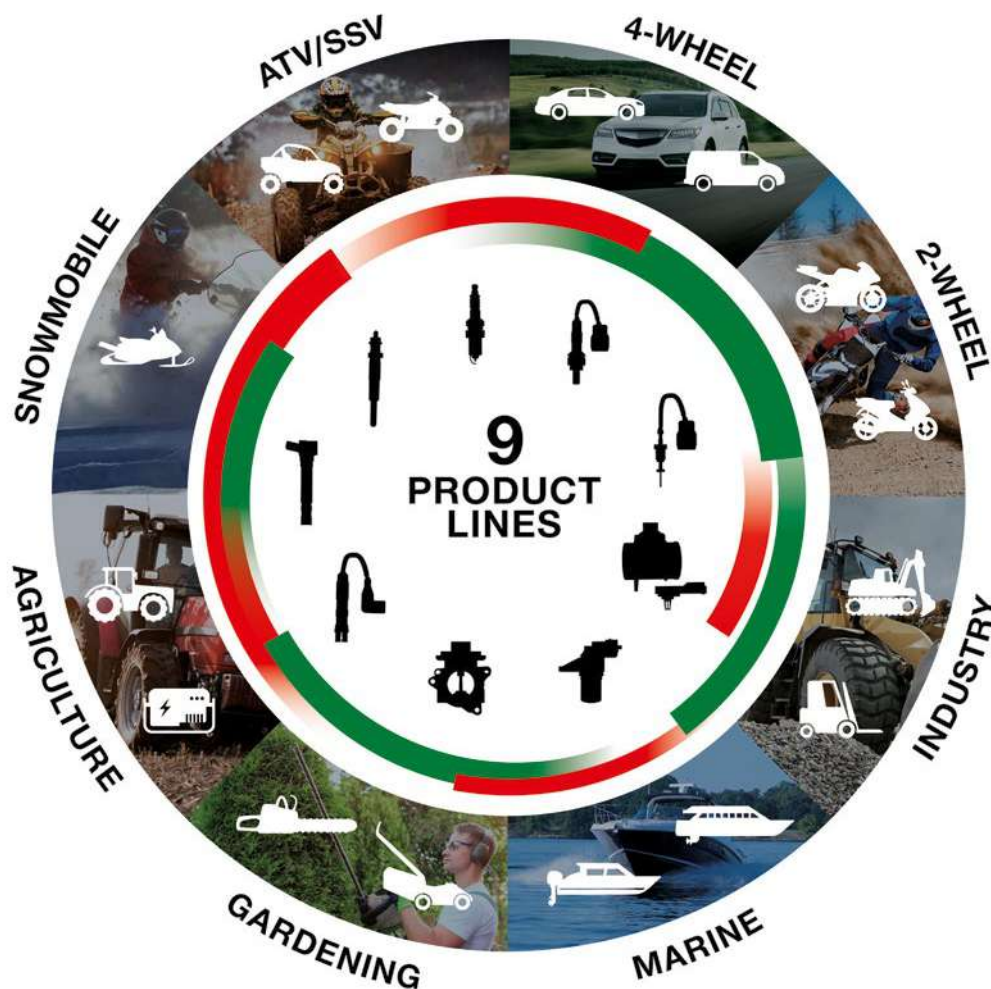

NGK – POWERED BY PERFORMANCE

Spark Plugs	Glow Plugs	Ignition Coils	Ignition Leads

NTK – POWERED BY PRECISION

Oxygen Sensors	Temperature Sensors	MAP/MAF Sensors	Engine Speed & Position Sensors	EGR Valves



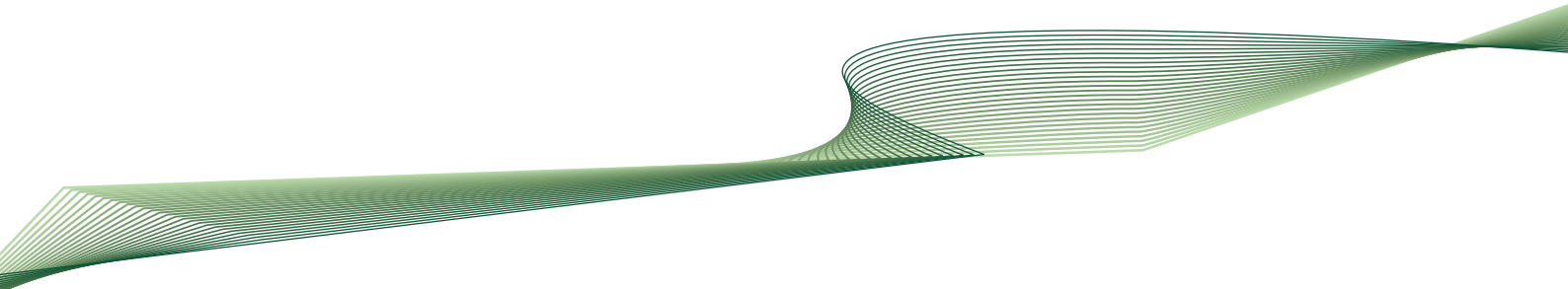

NGK SPARK PLUG EUROPE GmbH

Harkortstraße 41 • D-40880 Ratingen
Tel.: +49 (0) 2102 974-000 • Fax.: +49 (0) 2102 974-149



www.ngkntk.com



NGK SPARK PLUG CO., LTD.

EMEA // EUROPE-MIDDLE EAST-AFRICA